

# Operating manual

## Sat/TV/FM Test Receiver MSK 33



Software version 8.2

**KATHREIN**  
Antennen • Electronic



# Preface

Dear customer,

This following manual will help you obtain the best optimal use from the extensive functions of the MSK 33. Therefore, observe all instructions. The Kathrein-Werke KG has made every effort to ensure that the data and descriptions in this manual are accurate and complete.

We reserve the right to make changes to this manual without prior notice. This particularly applies to modifications required for technical improvement.

We appreciate your recommendations and improvement suggestions.

Publications, copies and print-outs as well as electrical distribution of this manual in full or in part is only allowed with written authorisation from the Kathrein-Werke KG.

All product names and trademarks used in this manual are the property of the relevant companies.

# Contents

|   |           |
|---|-----------|
| <b>PREFACE</b> .....                                      | <b>3</b>  |
| <b>IMPORTANT NOTES</b> .....                              | <b>12</b> |
| Validity of this manual.....                              | 12        |
| General safety information .....                          | 12        |
| Explanation of symbols.....                               | 12        |
| <b>SAFETY INSTRUCTIONS</b> .....                          | <b>13</b> |
| Connections.....  | 13        |
| Proper use .....  | 13        |
| Mechanical loadbearing capacity .....                     | 13        |
| <b>FUNCTIONS</b> .....                                    | <b>14</b> |
| Functions .....   | 14        |
| Functions overview.....                                   | 15        |
| <b>DISPLAYS, OPERATING ELEMENTS AND CONNECTIONS</b> ..... | <b>16</b> |
| Front panel.....  | 16        |
| Rear panel .....  | 17        |
| Observing angle of the on screen display .....            | 18        |
| <b>OPERATING CONCEPT</b> .....                            | <b>19</b> |
| The screen.....   | 19        |
| Frequently recurring softkeys .....                       | 19        |
| General information for operation.....                    | 20        |
| Menu selection .....                                      | 20        |
| The main menu.....  | 20        |
| <b>OPERATION</b> .....                                    | <b>21</b> |
| Place of installation of the MSK 33.....                  | 21        |
| Mains voltage / mains switch.....                         | 21        |
| On/Off switch .....                                       | 21        |
| Safety fuse.....  | 21        |
| <b>ACCUMULATOR AND BATTERY OPERATION</b> .....            | <b>22</b> |
| Accumulator operation.....                                | 22        |
| DC socket (option).....                                   | 22        |
| <b>CONNECTIONS</b> .....                                  | <b>23</b> |

# Contents

|  |           |
|--|-----------|
| RF output .....  | 23        |
| Headphone connection .....   | 23        |
| Modem / RS232 interface .....  | 23        |
| Scart socket .....   | 23        |
| Socket TS PARALLEL (optional) .....                                      | 23        |
| <b>MEASUREMENT POSSIBILITIES .....</b>                                   | <b>24</b> |
| Level measurement .....  | 24        |
| Maximal input level .....  | 24        |
| <b>SAT OPERATION .....</b>   | <b>25</b> |
| Sat menu .....   | 25        |
| Entry of the transponder frequency from 00,000 MHz to 16,000 MHz .....   | 25        |
| Setting of the LNB voltage supply: .....                                 | 26        |
| Selecting the LO frequency .....   | 26        |
| Entering the transponder frequency: .....                                | 26        |
| SCAN .....   | 27        |
| Calling up menu LNB-CONTROL .....  | 27        |
| Switch-over of ANALOG digit. DVBS .....                                  | 27        |
| Calling up the menu SAT MEASURE .....                                    | 27        |
| LNB control menu .....   | 28        |
| 22 kHz control signal .....  | 28        |
| 14 V LNB supply voltage .....  | 28        |
| 18 V LNB supply voltage .....  | 28        |
| LNB current draw .....   | 28        |
| Checking the LNB supply voltage of a satellite receiver .....            | 29        |
| Calling up the DiSEqC/V SEC menu .....                                   | 29        |
| DiSEqC menu .....  | 30        |
| RX assessment .....  | 30        |
| Transmitting and receiving a DiSEqC command (TX + RX) .....              | 30        |
| Sending a DiSEqC command (TX) .....                                      | 30        |
| Entry of the hex numbers .....   | 30        |
| RX display field .....   | 30        |
| Submenu for entering DiSEqC commands .....                               | 31        |
| Entry .....  | 31        |
| TX display field .....   | 31        |
| Display field A .....  | 31        |
| Display field B .....  | 31        |
| Entering and transmitting a DiSEqC command .....                         | 32        |
| Simple DiSEqC .....  | 32        |
| UFOmicro DiSEqC menu .....   | 33        |
| General information .....  | 33        |
| Display fields .....   | 33        |
| RX field .....   | 33        |
| Status field .....   | 33        |
| Receiver field .....   | 34        |
| TX field .....   | 34        |
| Operating the menus .....  | 34        |
| Installation of a UFOµ unit EXU 544 in conjunction with the MSK 33 ..... | 35        |

# Contents

|   |           |
|---|-----------|
| V-SEC menu .....  | 36        |
| Entering the hex numbers .....  | 36        |
| Sending a V-SEC command (TX) .....  | 36        |
| Initial ANALOG-menu .....   | 37        |
| Calling up the sound subcarrier menu .....                                    | 37        |
| Level-dependent acoustic signal .....   | 37        |
| Level measurement ANALOGUE .....  | 37        |
| Second ANLAOG menu .....  | 38        |
| Selecting the colour standards PAL, SECAM and NTSC .....                      | 38        |
| Selecting the video hub .....   | 38        |
| Video polarity .....  | 38        |
| Sat subcarrier menu .....   | 39        |
| Selecting the subcarrier reception type (refer to the subcarrier table) ..... | 39        |
| Audio carrier frequency .....   | 39        |
| Audio carrier setting .....   | 39        |
| Setting of the de-emphasis .....  | 39        |
| Audio carrier tables for the satellite reception .....                        | 40        |
| <b>DIGITAL MEASUREMENTS .....</b>   | <b>41</b> |
| SAT DIGITAL menu .....  | 41        |
| Level-dependent acoustic signal .....   | 41        |
| Convulsion code for Sat measurement .....                                     | 41        |
| Symbol rate entry .....   | 41        |
| MPEG decoder menu (OPTION) .....  | 41        |
| Level measurement DIGITAL (Min./Max. levels) .....                            | 42        |
| <b>TV OPERATION .....</b>   | <b>43</b> |
| TV menu .....   | 43        |
| Frequency entry of 44.75-867.2 MHz / DVB-T / BIII / UHF .....                 | 43        |
| Mid-channel display .....   | 43        |
| Entering in a channel .....   | 43        |
| Entering a special channel .....  | 43        |
| Selecting analogue, DVB-C and DVB-T measurement .....                         | 43        |
| Calling up the menu TV control .....  | 43        |
| TV control menu .....   | 44        |
| 22 kHz control signal .....   | 44        |
| LNB supply voltage .....  | 44        |
| Remote supply voltage .....   | 44        |
| Checking the supply voltage in a remotely fed system .....                    | 44        |
| Calling up the menu DiSEqC / VSEC .....                                       | 44        |
| TV-DiSEqC /VSEC menu .....  | 44        |
| Analogue menu .....   | 45        |
| Selecting the standard .....  | 45        |
| Selecting the audio carriers .....  | 45        |
| Level-dependent acoustic signal .....   | 45        |
| Carrying out measurements .....   | 45        |
| Measuring audio carrier spacing .....   | 46        |
| Measuring the Nicam audio carrier spacing and bit error rate .....            | 46        |
| Measuring the min./max. level .....   | 46        |
| Measuring the current level .....   | 46        |
| Selecting the colour standards PAL, SECAM and NTSC .....                      | 46        |

# Contents

|   |           |
|---|-----------|
| TV DIGITAL menu .....   | 47        |
| DVB-C.....  | 47        |
| Level-dependent acoustic signal .....                                       | 47        |
| Selecting demodulation for DVB-C measurement.....                           | 47        |
| Symbol rate entry .....   | 47        |
| DVB-T (optional).....   | 48        |
| Level-dependent acoustic signal .....                                       | 48        |
| Selecting channel bandwidths .....  | 48        |
| MPEG decoder menu (OPTION).....   | 48        |
| <b>RETURN PATH IF MENU .....</b>  | <b>49</b> |
| Return path IF menu.....  | 49        |
| Entering a frequency of 7.00 MHz up to 80.00MHz* .....                      | 49        |
| Inverting the RF spectrum* .....  | 49        |
| ANALOG Menu.....  | 49        |
| DIGITAL menu.....   | 49        |
| IF CONTROL menu (RP-CONTROL*) .....   | 49        |
| ANALOG menu.....  | 50        |
| Selecting the standard .....  | 50        |
| Level-dependent acoustic signal .....                                       | 50        |
| Carrying out measurements .....   | 51        |
| Measurement of the audio carrier spacing .....                              | 51        |
| Measurement of the Nicam audio carrier spacing and the bit error rate ..... | 51        |
| Measurement of the min./max. level .....                                    | 51        |
| Selecting the colour standards PAL, SECAM and NTSC .....                    | 51        |
| <b>IF RP DIGITAL MENU.....</b>  | <b>52</b> |
| DVB-C.....  | 52        |
| Level-dependent acoustic signal .....                                       | 52        |
| Selecting demodulation for DVB-C measurement.....                           | 52        |
| Entering symbol rate.....   | 52        |
| MPEG decoder menu (OPTION).....   | 52        |
| <b>RADIO OPERATION .....</b>  | <b>53</b> |
| RADIO menu .....  | 53        |
| Entering a frequency from 44.75 MHz to 867.20 MHz .....                     | 53        |
| RADIO CONTROL menu.....   | 53        |
| ANALOG menu.....  | 53        |
| RADIO ANALOG menu .....   | 53        |
| Level-dependant acoustic signal .....                                       | 53        |
| Carrying out measurements .....   | 53        |
| Measuring the min/max level.....  | 54        |
| Measuring the current level .....   | 54        |
| <b>AV MENU .....</b>  | <b>55</b> |
| Decoder operation .....   | 55        |
| Decoder operation baseband .....  | 55        |
| Video input.....  | 55        |
| Video output.....   | 55        |
| Breaking voltage .....  | 56        |
| RGB operation .....   | 56        |
| MPEG transport stream interface (TS-Parallel, LVDS) (optional) .....        | 56        |
| <b>MPEG DECODER MENU (OPTIONAL) .....</b>                                   | <b>57</b> |

# Contents

|   |           |
|---|-----------|
| <b>SETTING MENU</b> .....                                   | <b>58</b> |
| Modem menu .....  | 58        |
| Screen menu .....   | 58        |
| SYSTEM menu.....  | 58        |
| Measuring unit .....  | 58        |
| Entering the level offset .....                             | 58        |
| <b>SCREEN MENU</b> .....                                    | <b>59</b> |
| Setting the brightness .....                                | 59        |
| Setting the contrast.....                                   | 59        |
| Setting the colour saturation .....                         | 59        |
| Setting the background light .....                          | 59        |
| Factory setting .....                                       | 59        |
| <b>SYSTEM MENU</b> .....                                    | <b>60</b> |
| Calls up the SYSTEM menu .....                              | 60        |
| Setting the date .....                                      | 60        |
| Setting the time.....                                       | 60        |
| Click button .....  | 60        |
| Factory setting .....                                       | 60        |
| <b>COPY MENU</b> .....                                      | <b>61</b> |
| Saving and calling up unit settings .....                   | 61        |
| Saving the unit settings .....                              | 61        |
| Calling up saved settings .....                             | 61        |
| Calls up the panoramic printout menu .....                  | 61        |
| Printing out all measurements in TV mode .....              | 62        |
| Printing out all measurements in Sat mode .....             | 62        |
| <b>MODE MENU</b> .....                                      | <b>63</b> |
| <b>TEXT MENU</b> .....                                      | <b>64</b> |
| Holding the videotext page .....                            | 64        |
| Enlarging the videotext page .....                          | 64        |
| Original videotext size .....                               | 64        |
| <b>SCOPE MENU</b> .....                                     | <b>65</b> |
| Video scope menu.....                                       | 65        |
| Horizontal zoom –Enlarging the video signal .....           | 65        |
| Horizontal zoom – Reducing the video signal .....           | 65        |
| S/N measurement.....  | 65        |
| Measurement of the amplitude of the video signal.....       | 66        |
| Selecting the video line.....                               | 66        |
| Measurement of video signals via the AV socket (SCART)..... | 66        |
| <b>AUDIO SCOPE</b> .....                                    | <b>67</b> |
| Increasing time / unit .....                                | 67        |
| Reducing time / unit.....                                   | 67        |
| Position of the audio signal.....                           | 67        |
| Measuring the FM hub.....                                   | 67        |
| Measuring an audio signal via the AV socket (SCART).....    | 67        |
| <b>DISEQC SCOPE</b> .....                                   | <b>68</b> |
| Increasing time / unit .....                                | 68        |
| Reducing time / unit.....                                   | 68        |
| Saving function .....                                       | 68        |



# Contents

|   |           |
|---|-----------|
| Position and triggering of the DiSEqC signal .....                              | 68        |
| <b>SPECTRUM MENU .....</b>  | <b>69</b> |
| Level measurement of analogue signals .....                                     | 69        |
| Level measurement of digital signals .....                                      | 69        |
| Selecting the spectrum representation .....                                     | 70        |
| ANALOG marker .....   | 70        |
| DIGITAL marker .....  | 70        |
| C/N measurement of analogue signals in Sat operation .....                      | 70        |
| C/N measurement of digital signals in Sat operation .....                       | 71        |
| Cross-polarisation measurement on signals in SAT operation .....                | 71        |
| <b>CONST MENU .....</b>   | <b>72</b> |
| Colour representation of I/Q value pairs .....                                  | 72        |
| Constellation diagram for QPSK (DVB-S) .....                                    | 72        |
| Measurement of the bit error rate (BER) .....                                   | 72        |
| Measurement of signal noise ratio (SNR) .....                                   | 73        |
| Carrier offset .....  | 73        |
| Frontend locked .....   | 73        |
| Selecting the symbol rate (symbol-clock) .....                                  | 74        |
| Selecting the code rate .....   | 74        |
| Inverting /not invert ing a constellation diagram .....                         | 74        |
| Examples for QPSK constellation diagrams .....                                  | 75        |
| Constellation diagram for QAM (DVB-C) .....                                     | 76        |
| Measurement of the bit error rate (BER) .....                                   | 76        |
| Measurement of modulation error rate (MER) .....                                | 76        |
| Carrier offset .....  | 76        |
| Frontend locked .....   | 77        |
| Selecting the symbol rate (symbol-clock) .....                                  | 77        |
| Inverting /not inverting constellation diagram .....                            | 77        |
| Zoom .....  | 77        |
| Examples for QAM constellation diagram .....                                    | 78        |
| <b>DVB-T .....</b>  | <b>80</b> |
| Constellation diagram DVB-T (optional) .....                                    | 80        |
| Measurement of bit error rate (BER) .....                                       | 80        |
| Measurement of signal noise ration (SNR) .....                                  | 80        |
| Carrier offset .....  | 80        |
| Carrier mode .....  | 80        |
| Modulation .....  | 80        |
| Hierarchy .....   | 81        |
| Code rate .....   | 82        |
| Guard .....   | 82        |
| Invers .....  | 82        |
| Frontend locked .....   | 82        |
| Channel display .....   | 82        |
| Impulse response representation (Echo representation) (optional) .....          | 83        |
| <b>BROADBAND CABLE ANALYSIS MEASURING SYSTEM MSK 33 / MVG .....</b>             | <b>84</b> |
| Measuring principle .....   | 84        |
| Comfortable upstream 4.0...80 MHz and Downstream 47...860 MHz measurement ..... | 86        |
| Upstream measurement .....  | 86        |
| Downstream measurement .....  | 86        |
| <b>AUTO MEASURE .....</b>   | <b>88</b> |

# Contents

|   |           |
|---|-----------|
| Display of the check point.....                                     | 88        |
| Display of the entry field for the respective measurement task..... | 88        |
| <b>INTERFACES.....</b>  | <b>89</b> |
| Modem / RS 232 interface.....                                       | 89        |
| Connection cable for modem / RS 232 .....                           | 89        |
| Modem/RS232 menu.....   | 90        |
| Setting baud rate .....   | 90        |
| Setting local echo .....  | 90        |
| Setting hardware handshake.....                                     | 90        |
| Init (Initialisation string) for the MSK 33 modem.....              | 90        |
| Code (Password).....  | 91        |
| PIN1.....   | 91        |
| PIN2.....   | 91        |
| PIN3.....   | 91        |
| Operating of the MSK 33 via modem .....                             | 91        |
| The TTY mode.....   | 91        |
| the ANSI mode .....   | 91        |
| The log-in procedure .....  | 91        |
| Requesting help.....  | 92        |
| List of the command abbreviations.....                              | 94        |
| <b>MAINTENANCE, STORAGE AND CUSTOMER SERVICE.....</b>               | <b>96</b> |
| Maintenance .....   | 96        |
| Unit calibration .....  | 96        |
| Exterior cleaning.....  | 96        |
| Interior cleaning .....   | 96        |
| Function testing .....  | 96        |
| Exchange of components.....   | 96        |
| Storage .....   | 96        |
| Customer service.....   | 96        |
| Printer paper-exchanging the ribbon .....                           | 97        |
| <b>TECHNICAL APPENDIX.....</b>                                      | <b>98</b> |
| Overview of DiSEqC commands .....                                   | 98        |
| Command overview framing byte.....                                  | 98        |
| Command overview address byte.....                                  | 98        |
| Command overview command byte .....                                 | 99        |
| Command overview data byte .....                                    | 100       |
| DiSEqC commands for Kathrein matrices.....                          | 100       |
| Command for Kathrein matrix 9xx-series .....                        | 100       |
| Command for Kathrein matrix EXR 20 .....                            | 100       |
| Command for Kathrein matrix EXR 22 .....                            | 100       |
| Channel tables.....   | 101       |
| Channel and frequency table standard B/G (frequency in MHz).....    | 101       |
| Channel and frequency table standard L(frequency in MHz).....       | 102       |

# Contents

|   |            |
|---|------------|
| Channel and frequency table standard D/K (frequency in MHz) ..... | 103        |
| Channel and frequency table standard I (frequency in MHz) .....   | 104        |
| Channel and frequency table standard M/N (frequency in MHz) ..... | 105        |
| Channel and frequency table standard M/N(frequency in MHz) .....  | 106        |
| Special channels .....  | 106        |
| <b>TECHNICAL DATA .....</b>                                       | <b>107</b> |
| Technical data .....  | 107        |
| Scope of delivery .....   | 109        |
| Accessories .....   | 109        |
| Assignment of the SCART socket .....                              | 109        |
| Assignment of RS232 socket .....                                  | 110        |
| Assignment of socket TS PARALLEL (optional) .....                 | 111        |
| Unit variants .....   | 112        |
| MSK 33/G .....  | 112        |
| MSK 33/Q .....  | 112        |
| MSK 33/M .....  | 112        |
| MSK 33/QR, MSK 33/MR with return path card .....                  | 112        |
| MSK 33/TQ .....   | 112        |
| MSK 33/TM .....   | 112        |
| <b>DOWNLOADING NEW MSK33 OPERATING SOFTWARE .....</b>             | <b>113</b> |
| General notes: .....  | 113        |

# Important Notes

## Validity of this manual

This manual is valid for the MSK 33, order no.: 208 299, 208 302, 208 303, 208 305, 208 209, 208 311, 208 312, 208 313, 208 314, 208 316, 208 318, 208 319, 208 321, 208 322, 208 325, 208 326, 217 10001, 217 10002, 217 10003, 217 10004.

The following notes are relevant for the operation of the MSK 33 and should be adhered to under all circumstances.

## General safety information

The MSK 33 has been developed and produced in consideration of the relevant harmonised guidelines, standards as well as further technical specifications. The product complies with the latest technology and ensures a high degree of safety.

However, this safety can only be achieved during operation, if all required measures have been met and the operator's obligation of care is applied.

## Explanation of symbols

In the following operating instructions, the following symbols are used. These symbols are intended to make the user aware of the text located next to the symbol.



### **Danger! Parts under dangerous voltage!**

This symbol indicates, that there is danger to health and life.



### **Attention!**

This symbol indicates, that this section of the instructions should be closely observed.



### **Observe note!**

**Information, which provide a better understanding of the working procedures.**



### **Example**

This symbol provides information on measuring functions and refers you to chapters containing further information regarding the subject.

# Safety Instructions



- Observe the VDE safety regulations!
- Observe the admissible maximum level when feeding signals.
- A maximum of 0.5 watts of total power may be applied to the RF input.
- Only fuses which have the same cut out characteristic may be used.
- The unit is also live when disconnected.
- In order to avoid electromagnetic interference, the unit may only be operated with all screening covers and in a closed condition. Furthermore, make sure that only suitable shielded cables are used.
- There is a danger to life during mains operation when the unit is improperly tampered with!

## Connections



Faulty wiring can lead to operating disturbance or defects.

## Proper use



The operator must make sure, that

- the signal meter is only used in accordance with the requirements,
- the signal meter is only operated in a perfect, functional condition,
- the safety instructions and warnings on the signal meter are not removed and remain legible.

## Mechanical loadbearing capacity

The MSK 33 is designed for mobile use and the mechanical demands made there. After strong mechanical loads such as collisions, hits or drops, the MSK 33 may no longer be used because this could damage the unit.

## Functions

With Sat/TV/FM signal meter MSK 33, detailed quality assessment of DVB-C, DVB-T and DVB-S signals may be carried out along with level measurements of analogue and digital TV and Sat reception signals. The unit is constructed in modular technology, so future function extensions by means of plug-in cards are easily possible.

The MSK 33 can be optionally supplied with power via the integrated lead accumulator of the integrated power supply unit (110...240 V~). A microcontroller is responsible for controlling the unit and scanning the keyboard entries with the hard and softkeys as well representing the level and frequency on the integrated TFT display screen. The high definition display screen allows a precise picture assessment.

Four different detectors for peak, average, maximal and minimal values are available for the level measurement of analogue and digital signals. Correction values are determined by the level calibration of the MSK 33 and stored in an EEPROM. This allows precise level measurements to be made with the MSK 33.

The MSK 33 is developed for the standards B/G, D/K, I, L, M, M Japan and Nicam. The video signal can be processed and reproduced in the colour standards PAL, SECAM and NTSC.

There is a bar display on the front display to help locate transmitters. In addition, a level-dependent acoustic tracking signal simplifies the alignment of an antenna without having to look at the screen.

The LNB supply voltage is 10 V...20 V for max. 500 mA in increments of 0.1 V. For control of the receiving system, the 22 kHz signal as well as the commands for DiSEqC 2.0, UFO $\mu$ -DiSEqC or V-SEC commands can be produced.

Level values, frequencies and plus the entire frequency spectrum can be printed out via the integrated dot-matrix printer.

# Functions

## Functions overview

| Function   | SAT            |               | TV           |               | Return path (LP) |          | FM           |
|--|----------------|---------------|--------------|---------------|------------------|----------|--------------|
|  | Digital        | Ana-<br>logue | Digital      | Ana-<br>logue | Digital          | Analogue |              |
| Mains and battery operation                          | X              | X             | X            | X             | X                | X        | X            |
| External battery supply                              | X*             | X*            | X*           | X*            | X*               | X*       | X*           |
| Picture assessment                                   | X*             | X             | X*           | X             | X*               | X*       | -            |
| DVB level measurement (DVB-S/C/T)                    | DVB-S          |               | DVB-T/C      |               | DVB-T/C          |          | -            |
| Level measurement by frequency entry                 | X              | X             | X            | X             | X*               | X*       | X            |
| Level measurement by channel entry                   |                |               | X            | X             |                  |          |              |
| IF level measurement (4...80 MHz)*                   |                |               | 36.15 MHz    | 38.9 MHz      | X*               | X*       |              |
| Constellation analysis                               | X*             |               | X*           |               | X*               |          |              |
| Level-dependent acoustic signal                      | X              | X             | X            | X             | X*               | X*       | X            |
| Loudspeaker for sound control                        | X*             | X             | X*           | X             | X*               | X*       | X            |
| Multi-standard (B/G, D/K, I, L, M, M jap)            |                |               |              | X             |                  | X*       |              |
| Audio carrier setting                                |                | X             |              | X             |                  | X*       |              |
| Audio carrier measurement                            |                |               |              | X             |                  | X*       |              |
| Nicam audio reception and bit error rate measurement |                |               |              | X             |                  | X*       |              |
| Min./Max. level measurement                          | X              | X             | X            | X             | X*               | X*       | X            |
| Representation of frequency spectrum                 | X*             | X*            | X*           | X*            | X*               | X*       | X*           |
| Print-out of frequency spectrum                      | X              | X             | X            | X             | X*               | X*       | X            |
| Frequency range                                      | 920...2150 MHz |               | 47...867 MHz |               | 4...80 MHz       |          | 88...108 MHz |
| Colour standard selection (PAL/NTSC/Secam)           |                | X             |              | X             |                  | X*       |              |
| Remote control via modem                             | X              | X             | X            | X             | X*               | X*       | X            |
| Remote feeding voltage 10...20 V / 500 mA            | X              | X             | X            | X             | X*               | X*       | X            |
| 22 kHz switch-over                                   | X              | X             | X            | X             | X*               | X*       | X            |
| DiSEqC 2.0, Simple DiSEqC, V-SEC, UFO $\mu$ -DiSEqC  | X              | X             | X            | X             | X*               | X*       | X            |
| Baseband output Decoder operation                    |                | X             |              |               |                  |          |              |
| Video output and input (Scart)                       | X*             | X*            | X*           | X*            | X*               | X*       |              |
| Video output (BNC)                                   | X*             | X*            | X*           | X*            | X*               | X*       |              |

X\* = only optional

# Displays, Operating Elements and Connections

## Front panel

All operating elements, the display screen and the RF input are located on the front panel of the MSK 33.



- |   |   |
|---|---|
| <p><b>1</b>    <b>TFT display screen</b></p> <p><b>3</b>    <b>Numerical entry field</b></p> <p><b>5</b>    <b>Vol- and Vol+:</b> Volume adjustment<br/><b>Ch- and Ch+:</b> Channel switching<br/>For some unit functions, the four functions function as cursors.</p> <p><b>7</b>    <b>Menu mode</b><br/>Unit settings such as videotext, spectrum analysis, constellation analysis, auto-measure, scope and MVG 10 tracking can be made here.</p> <p><b>9</b>    <b>OSD/Help button</b><br/>On/Off switch of the on screen display</p> <p><b>11</b>   <b>BNC RF input socket</b></p> | <p><b>2</b>    <b>Softkeys</b><br/>The functions of the individual softkeys are indicated on the right-hand side of the screen.</p> <p><b>4</b>    <b>Selection buttons</b><br/>Confirmation of units and entries</p> <p><b>6</b>    <b>On/Off switch (Standby)</b><br/>Quickly press this button to switch the unit on or off. When you switch off the MSK 33 by pressing this button, the last unit setting is saved. When the unit is switched on again, the unit remains in the last used type of operation. Hold the button down for ca. 4 seconds to finally switch off the unit (processor-reset).</p> <p><b>8</b>    <b>Menu copy</b><br/>Here are all the unit settings for the printer memory and data output.</p> <p><b>10</b>   <b>LED-DC</b><br/><b>The red LED lights up, as soon as the remote power voltage is switched on or DC voltage is present on the antenna cable.</b></p> <p><b>12</b>   <b>LED mains</b><br/>The green LED lights up, as soon as the MSK 33 is connected to the mains and the mains switch on the rear panel of the unit is switched on.</p> |
|---|---|



# Displays, Operating Elements and Connections

## Rear panel

The interfaces, output and input sockets and the mains connection are located on the rear panel of the MSK 33.

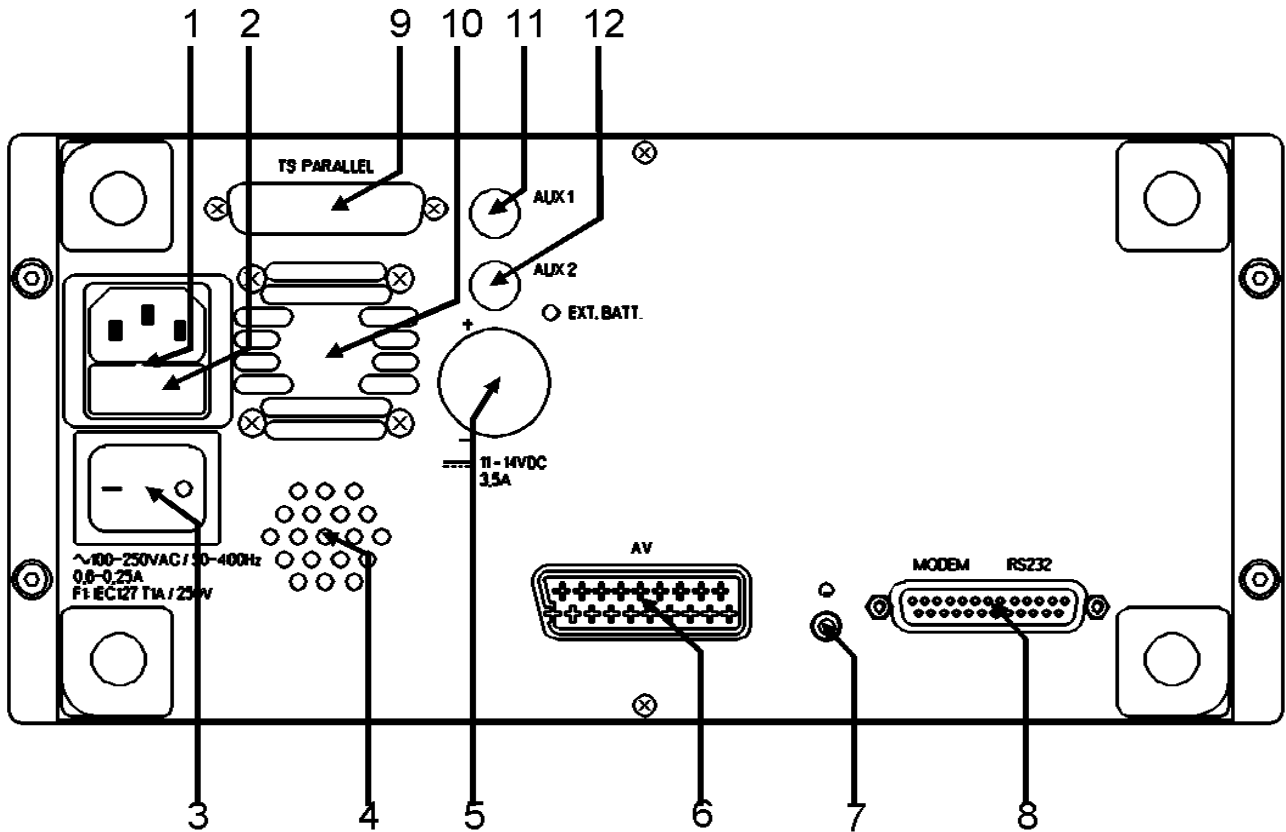

- |   |   |
|---|---|
| <p>1 Mains connection</p> <p>3 Mains switch</p> <p>5 <b>DC socket (Option / XLR-socket)</b><br/>for the operation of an external DC voltage of 10.8...14 V and for charging the accumulator</p> <p>7 <b>Headphone connection</b><br/>3.5 mm jack plug for stereo headphones</p> <p>8 <b>TS parallel</b><br/>Option</p> <p>10 <b>AUX 1</b><br/>unoccupied or BNC socket for video output</p> | <p>2 Mains fuse</p> <p>4 Loudspeaker</p> <p>6 Scart socket</p> <p><b>Interface RS 232 / modem</b><br/>For modems for remotely controlling the MSK 33 and for the software download</p> <p>9 Ventilators</p> <p>11 <b>AUX 2</b><br/>unoccupied</p> |
|---|---|

# Displays, Operating Elements and Connections

## Observing angle of the on screen display

The viewpoint of the TFT display is chosen so that a picture assessment is seen from an angle of up to 15° from the top and up to 30° from below. The observing angle from the side is  $\pm 45^\circ$ .

### MSK 33 front view



The angle of view from the side to the TFT display is  $\pm 45^\circ$ .

### Side view MSK 33

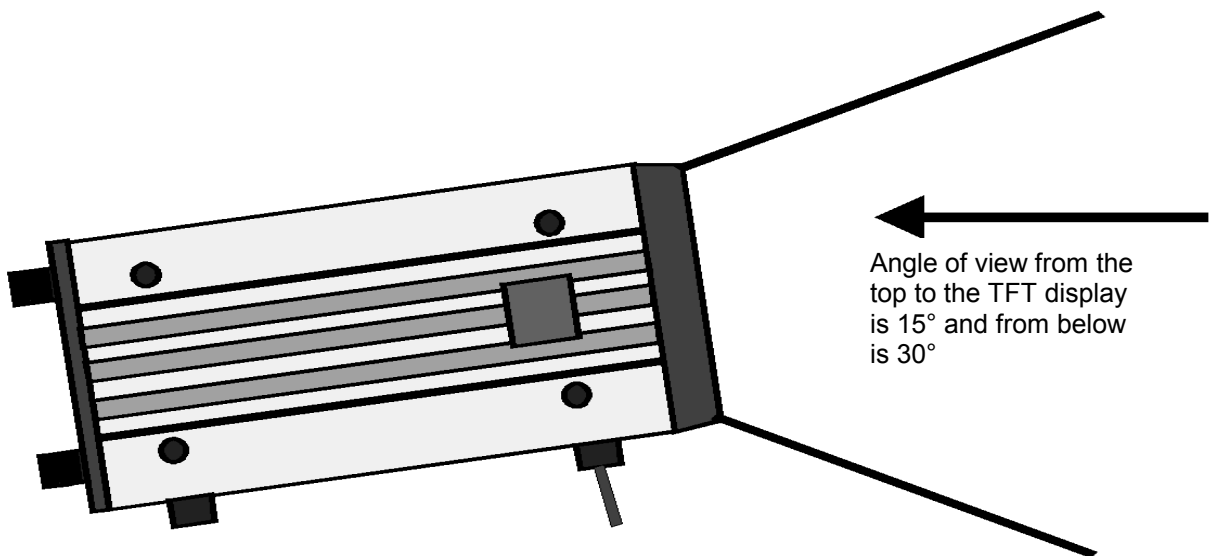

Angle of view from the top to the TFT display is 15° and from below is 30°

# Operating Concept

## The screen

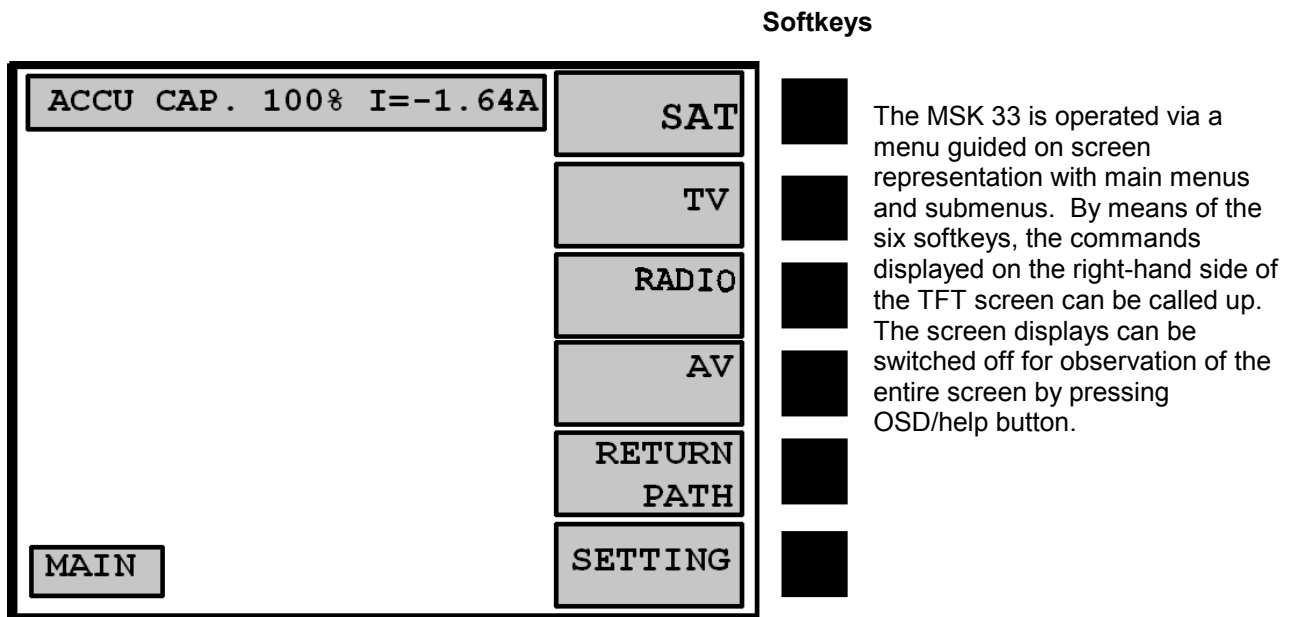

## Frequently recurring softkeys



With this softkey, you always return to the previous menu.



Level-dependent acoustic tracking signal

The acoustic tracking signal is generated in the function, „level beep.“ The pitch of the sound is proportionate with the received signal level. This allows optimal alignment of the receiving antenna to a transmitter. The volume is adjustable.

# Operating Concept

## General information for operation



The following explanations are important for understanding the logical menu structure of the MSK 33. Please take time carefully reading the following paragraphs.

### Menu selection



*The MSK 33 is operated via the buttons and various displayed screen menus. The selection of the menu items are effected by the softkey buttons on the right of the display. Submenus are immediately called up by pressing the respective softkey button. When a function is switched on, the fields next to the buttons are lit up in yellow. Buttons, which have multiple functions, are indicated with an arrow „▶“ and displayed in yellow when active. By repeatedly pressing a softkey, the different functions or parameters are called up and displayed.*

Softkeys with the arrows „◀“ or „▶“ indicate operation with the cursor buttons.

Softkeys with large type lead you to a new menu.

### The main menu

In the main menu, the following submenus can be called up by pressing the respective softkey:

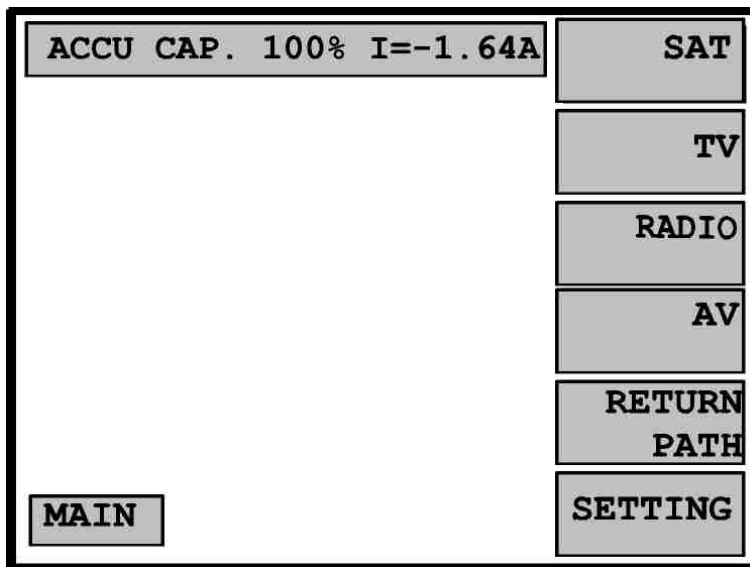

SAT – Settings for measuring satellite signals

TV – Settings for measuring TV signals

RADIO – Settings for measuring radio signals

AV – Settings for operation of the unit via the Scart socket or the optional interface TS PARALLEL for digital signals

RETURN PATH – Settings for measurements in the return path from 4 to 80 MHz. If the return path option is not occupied, the softkey is marked with „IF“ and measurements can be carried out in the IF levels at 38.9 MHz (analogue) and 36.15 MHz (digital).

SETTING – Settings for the RS232 interface, screen, date and time.

In the upper left-hand corner of the main menu, the loading status of the accumulator and the charging or discharging current are displayed.

## Place of installation of the MSK 33



When installing the unit, ensure, that there is adequate heat dissipation.

To avoid heat build-up, the openings for the ventilators and the ventilation slots on the top of the unit must always be free.

Use the leather case MZK 15 from Kathrein for mobile use.

## Mains voltage / mains switch

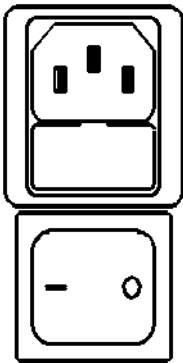

~100-250VAC / 50-400  
0.6-0.25A  
F1 IEC 127 T1A / 250V

The unit can be operated on AC current networks of 110...240 V with a network frequency of 50...400 Hz. The unit is automatically set within the allowed voltage range on the connected voltage.

The mains connection socket is located on the rear panel of the unit, and the mains switch is located underneath the mains socket. As soon as the power supply is connected, the green LED lights up on the front panel of the unit and the internal accumulator is charged.

## On/Off switch

With the On/Off button on the front panel of the unit, the MSK 33 can be switched on and off. When the MSK 33 is switched off with this button, the last unit setting is stored and activated again when the unit is switched on again.

## Safety fuse



For exchanging the mains fuse, please proceed as follows:

- Before exchanging the fuse, the power supply to the unit must be disconnected.
- First, remove the fuse holder . To do so, insert a screwdriver into the designated gap and pull out the fuse holder.
- After exchanging the fuse, reinsert the fuse holder into the unit.

Only use the following fuse types for the MSK 33:

**F1: IEC 127 T1 A / 250 V**

**Despite mains separation, the unit can still contain voltages via the battery!**

# Accumulator and Battery Operation

## Accumulator operation

The accumulator of the MSK 33 is not charged in delivery status and must be charged before initial operation. To do so, connect the unit with the mains, and switch on the power supply with the mains switch on the front panel of the unit. When the green LED on the front panel lights up, the accumulator is charged. The charging time of an empty accumulator is about 6-7 hours.

After a complete discharge or during longer pauses of operation, the accumulator must be recharged as soon as possible, otherwise the accumulator may be damaged or even destroyed.

The charging procedure automatically starts after the unit has been connected to the mains and switched on. Overload of the accumulator is not possible.

An internal over-discharging guard circuit automatically switches off the unit at a capacity of 0%.

The maximal operating time with a charged accumulator is ca. 80 minutes (without LNB voltage supply). For the LNB supply of 200 mA, the accumulator operating time is about 1 hour.

The unit should be connected to the mains during longer pauses of operation (conservation of the battery).

Improper handling of the accumulator can damage the unit and result in **total breakdown**.

The loading status of the built-in lead accumulator can be determined in the main menu. The following displays are available:

| Operating mode | Loading status charging-discharging current |
|----------------|---|
| Mains          | CHARGING : 53% I = 0.76 A                   |
| Battery        | ACCU CAP. : 90% I = -1.30 A                 |



## DC socket (option)

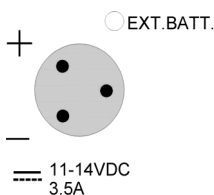

The DC socket (XLR socket) is located on the rear panel of the MSK 33. The unit can be operated via this socket with a DC source of 11...14V (auto battery or power supply unit). The charging of the internal unit accumulator is also possible via this socket.

**Here, disconnect the LNB voltage supply.**

**The operation of the MSK 33 guaranteed but not the charging of the internal accumulator.**

**Only use the supplied cables with the original connectors.**

If the external DC voltage decreases below 11 V, the MSK 33 automatically stops the loading process of the internal battery and operation via the external power supply. As soon as the fed -in voltage reaches 13.5 V, the MSK 33 switches over again to external DC operation and charging of the internal accumulator. This function is indicated by the green LED on the rear panel of the unit.



# Connections

## RF output

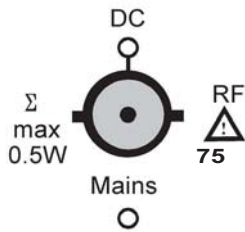

The receiving signal is fed into the RF input socket (BNC socket). It delivers also the remote power feeding voltage.

The remote power feeding voltage is adjustable and disconnectable from 10 to 20V. For control, the red LED over the RF input socket lights up when the LNB voltage is switched on. The green LED underneath the input socket lights up, when the MSK 33 is connected to the mains.

Make sure that,



- no voltage level over 130 dB $\mu$ V,
  - no positive DC voltage over 30 V<sub>DC</sub>,
  - no negative DC voltage and
  - no AC voltage over 70 V<sub>AC</sub>
- is connected to the RF input socket.

Exceeding these values can damage the input stages and the unit!

## Headphone connection

In order to better assess the sound quality, a connection of stereo headphones to the 3.5 mm jack socket (rear panel, position 7) is possible. The MSK 33 provides a stereo signal in Sat and TV operation and for FM a mono signal, each according to the transmission type, on the headphone connection.

## Modem / RS232 interface

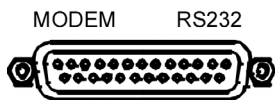

The serial interface RS 232 is designed as a 25-pin SUB-D socket. It requires a new software for controlling the MSK 33 and charging.

## Scart socket

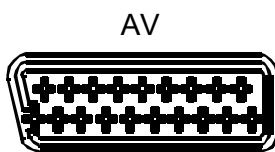

A monitor or television set (video or RGB) can be connected to the Scart socket. It is possible to feed in a video signal via the Scart socket and watch a picture on the MSK 33. For the connection of a decoder, the Scart socket can be configured as a decoder socket (Menu AV), in order to receive encrypted signals.

Occupying the Scart socket is shown in the chapter, „Technical Data“.

## Socket TS PARALLEL (optional)



The MPEG decoder can be connected to this socket or the MPEG data stream can be fed-in for picture assessment.

# Measurement Possibilities

## Level measurement

The MSK 33 is designed for the level measurements on receiving systems in the measuring range of 30 dB $\mu$ V to 130 dB $\mu$ V. The level measurement is automatically carried out after connecting the unit and setting a frequency and is displayed on the display screen. The table shown below represents a brief overview of the measurement possibilities of the MSK 33.

| Measurement possibility   | Type of operation | Menus                      |
|---|-------------------|----------------------------|
| DiSEqC 2.0  | SAT               | SAT, LNB-CONTROL, DiSEqC   |
| DiSEqC 2.0  | TV                | TV, TV-CONTROL, DiSEqC     |
| DiSEqC 2.0  | FM                | RADIO, RADIO-CONTROL       |
| UFO $\mu$   | SAT               | SAT, LNB-CONTROL, DiSEqC   |
| LNB current draw  | SAT               | SAT, LNB-CONTROL           |
| Level measurement SAT analogue  | SAT               | Sat MENU - analogue        |
| Level measurement TV analogue   | TV                | TV MENU - analogue         |
| Level measurement RADIO analogue  | FM                | RADIO-MENU                 |
| Level measurement SAT digital   | SAT               | SAT, digital DVB-S         |
| Level measurement TV digital  | TV                | TV, digital DVB-C or DVB-T |
| Min./Max. level measurement   | SAT               | SAT, SAT MEASURE           |
| Min./Max. level measurement   | TV                | TV, TV MEASURE             |
| Min./Max. level measurement   | FM                | RADIO                      |
| Current draw of a remotely fed-in unit  | TV                | TV, TV-CONTROL             |
| Current drain of a remotely fed-in unit   | FM                | RADIO, RADIO-CONTROL       |
| Sound carrier measurement<br>Nicom bit error measurement<br>Min./Max. level measurement | TV                | TV, analogue, TV MEASURE   |
| IF level  | IF                | IF                         |

## Maximal input level



The maximal measurable input level of a carrier, which can be measured with the MSK 33, is 130 dB $\mu$ V. If a system with several carriers or programmes is measured, the maximal total capacity of all carriers determines the admissible input level. The fed-in total capacity on the RF socket of the MSK 33 may not exceed 0.5 W.

The following table serves to approximately determine the maximal total capacity. It only applies, if all the carriers contain the same level. When the carriers are doubled, the maximal input level of the MSK 33 is reduced by 3 dB, refer to the table below.

| Number of the fed-in carriers | Reduction | Maximal input level, if all carriers contain the same level |
|-------------------------------|-----------|---|
| 4 TV programmes               |           | 129 dB $\mu$ V  |
| 9 TV programmes               | -3 dB     | 126 dB $\mu$ V  |
| 18 TV programmes              | -6 dB     | 123 dB $\mu$ V  |
| 36 TV programmes              | -9 dB     | 120 dB $\mu$ V  |

**Exceeding the maximal input level may damage the input stages or the unit! Intermodulation and overcontrol effects can occur for each maximal admissible assignment!**



# Sat Operation

## Sat menu

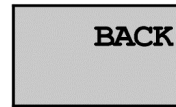
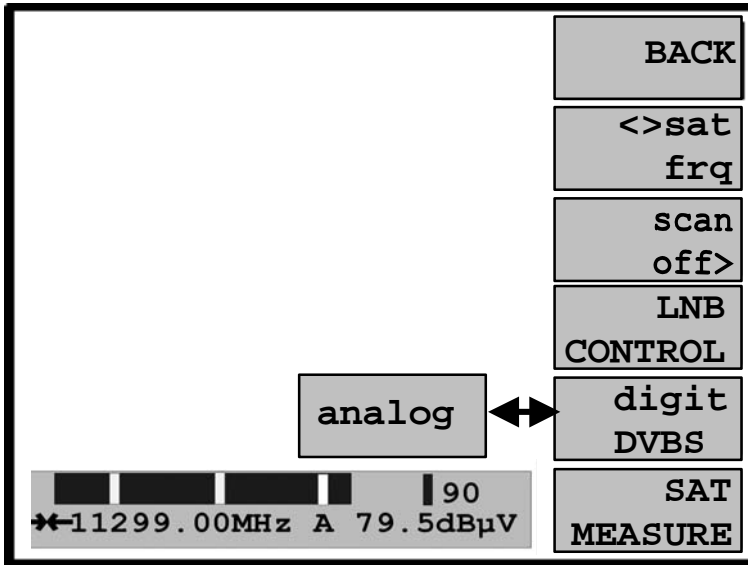

Call up the main menu

## Entry of the transponder frequency from 00,000 MHz to 16,000 MHz

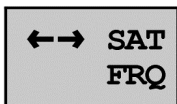

The field lights up yellow, as soon as a softkey is pressed. Now, the transponder frequency can be entered-in using the numerical buttons „0-9“ and „MHz“ or changed with the cursor buttons, ◀ ▶ . The transponder frequency is displayed in the lower left-hand corner of the on screen display. The receiving frequency depends on the selected LO frequency. The setting of the LO frequency is made in the menu ‚LNB-CONTROL.‘ The entry of the Sat IF is only possible, if the LO frequency LO-0 (00000) has been set.

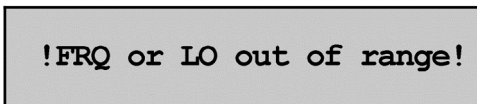

If the oscillator frequency (LO-0 to LO-9) is set, and the resulting receiving frequency lies out of the Sat receiving range (920...2150 MHz) of the MSK 33, this display shown on the left appears. Correct the LO frequency or the frequency entry after this message appears.



Example

Reception and level measurement of a Sat programme:

Transponder frequency 11,348 MHz vertical with a LNB with a LO frequency of 9.75 MHz.

By pressing the softkey SAT in the main menu, the unit switches to satellite reception.

# Sat Operation

## Setting of the LNB voltage supply:

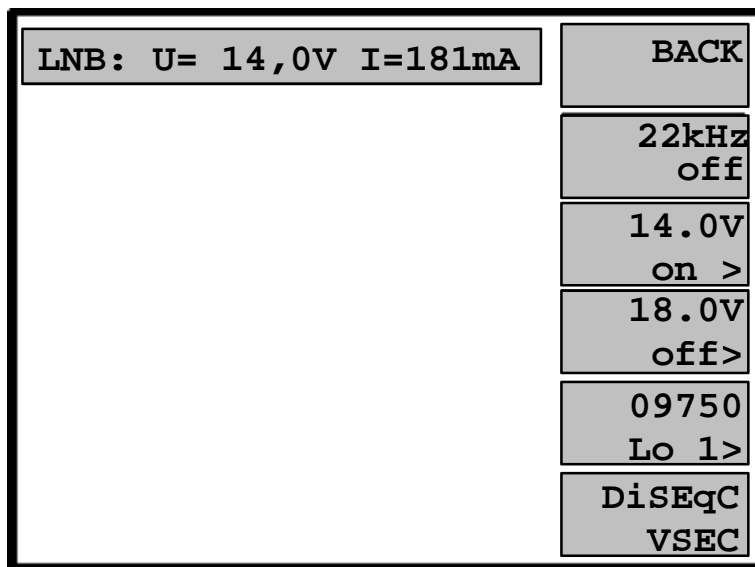

Activate the supply voltage for vertical polarisation 14.0 V in the LNB-CONTROL menu. In the upper display field, the supply voltage (14.0 V) and the current draw of the LNB (181 mA) are displayed. Press the BACK button to open the Sat menu once more.

LNB control menu

## Selecting the LO frequency

Press the LNB-CONTROL button in the Sat menu. With the button LO, you can request nine preset LO frequencies. Set LO1 (09750) in the field. With the BACK button, open the Sat menu again.

## Entering the transponder frequency:

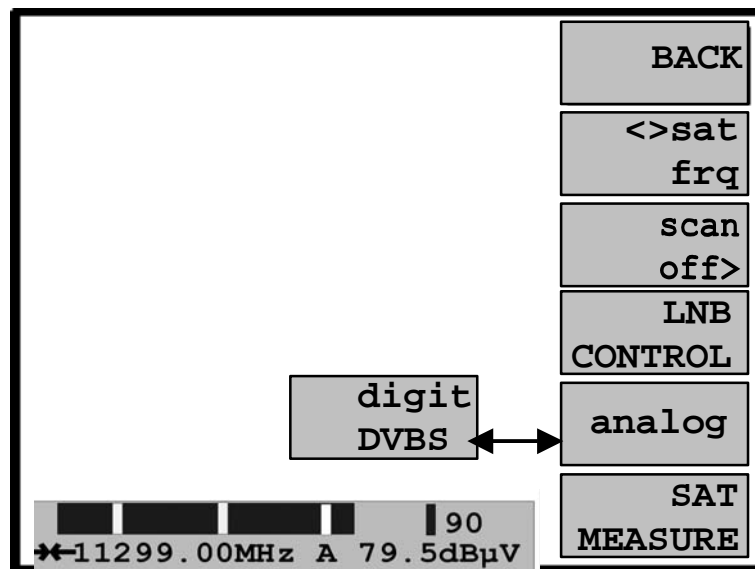

Press the button *sat frq* and enter the transponder frequency 11299 MHz with the numerical buttons. Confirm the entry with the MHz button. You will now see the frequency and level in the lower display field.

SAT menu

# Sat Operation

## SCAN

With the function **SCAN**, satellites can be searched for, whose transponder frequencies are not known. Here, the frequency range of 920 to 2150 is continuously scanned for the receiving signals. If the receiving signals are available, the reception level is displayed on the screen as a bar diagram. Four measurement ranges with the dynamic of each 40 dB are available for the bargraph display. The measurement range is automatically preselected.

| Bargraph display | Level range       | Comment                                     |
|------------------|-------------------|---|
| I                | 30-70 dB $\mu$ V  | Automatic range change at 70 dB $\mu$ V     |
| II               | 50-90 dB $\mu$ V  | Auto. range change at 50 and 90 dB $\mu$ V  |
| III              | 70-110 dB $\mu$ V | Auto. range change at 70 and 110 dB $\mu$ V |
| IV               | 90-130 dB $\mu$ V | Automatic range change at 90 dB $\mu$ V     |

The level can be controlled with an acoustic signal. The frequency of the acoustic signal varies in proportion with the receiving signal level. The volume of the acoustic signal can be changed.

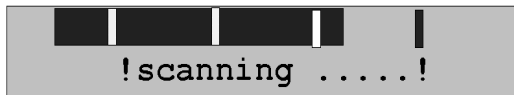

The screen shows the bargraph display, which changes in proportion with the input signal.

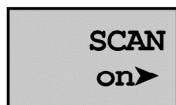

The field **SCAN** lights up yellow, as soon as the softkey is pressed. The entire Sat frequency range is now scanned. By pressing the button once more, the process is stopped and the softkey display changes to "scan off."

### Calling up menu LNB-CONTROL

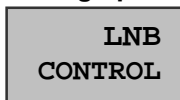

In this menu, all LNB parameters can be set, for example, remote power feeding voltage H/V, 22-kHz-, DiSEqC-, V-SEC signal, UFO $\mu$  DiSEqC as well as LO frequency.

### Switch-over of ANALOG digit. DVBS

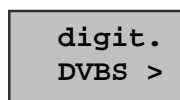
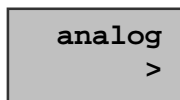

### Calling up the menu SAT MEASURE

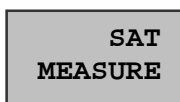

In this menu, all Sat receiving parameters for the reception of digital or analogue signals can be set and the measurements can be carried out. Calls up the MPEG-Decoders for digit. DVB-S.

## LNB control menu

In the LNB control menu, the LNB supply voltage, 22 kHz control signal, DiSEqC and VSEC commands can be set. The voltage or signals are available on the RF socket. If the LNB supply voltage is activated, the red LED above the RF sockets lights up.

Selection of menu items: refer to section „Operating concept.“

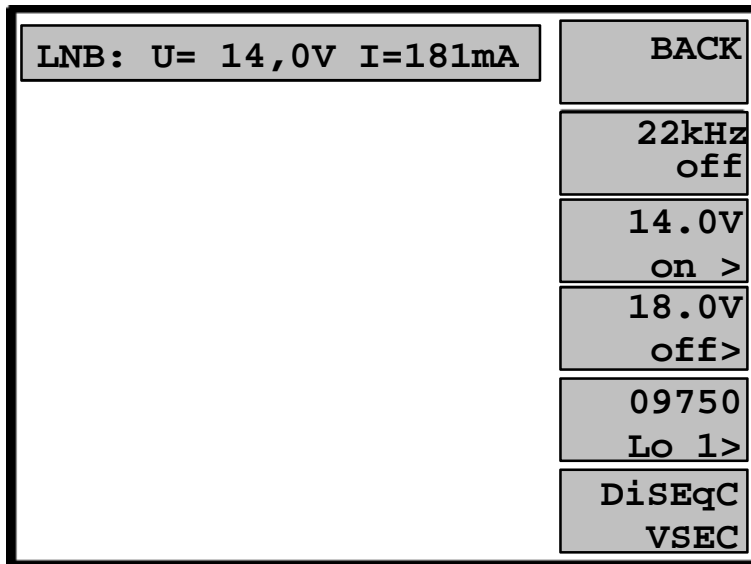

### 22 kHz control signal



The field lights up yellow, as soon as the softkey is pressed. The switchable 22 kHz signal superposes the

LNB voltage. By pressing the button once more, the 22 kHz signal is disconnected again.

### 14 V LNB supply voltage



The field lights up yellow, as soon as the softkey is pressed. The LNB supply

voltage of 14.0 V for the vertical polarisation is now switched on. For control, the LED above the RF input socket lights up. The voltage can be changed in the range of 10...20 V with the buttons, 1...9, or with the cursor buttons, ◀▶. For numerical entry, the entry must be completed with „Enter.“ By pressing the button once more, the LNB supply voltage is disconnected again.

### 18 V LNB supply voltage

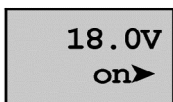

The field lights up yellow, as soon as the softkey is pressed. The LNB supply voltage of 18.0 V for the horizontal polarisation is available on the input socket. The voltage can be changed in the range of 10...20 V with the buttons, 0...9, or with the cursor buttons, ◀▶. For numerical entry, the entry must be completed with „Enter.“ By pressing the button once more, the LNB supply voltage is disconnected again.



#### The LNB voltage is

- disconnectable= 0V
- changeable from 10...20 V in 0.1-V increments
- short-circuit proof max. current 500 mA

### LNB current draw

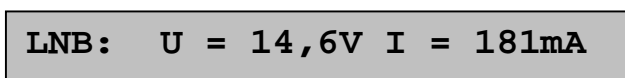

This field shows the current draw ( $I = 181 \text{ mA}$ ) and the supply voltage (14.6 V) of the LNB.

# Sat Operation

## Checking the LNB supply voltage of a satellite receiver

Connect the satellite receiver (IF input) with the MSK 33 (RF input socket). Switch the supply voltage of the MSK 33 OFF and the voltage of the receiver ON. You can now read the output voltage on the screen.

## Calling up the DiSEqC/V SEC menu

DiSEqC  
VSEC

In this menu, all the DiSEqC/V SEC control possibilities can be set ( refer to section ,DiSEqC/V-SEC menu').



In case the MSK 33 is equipped with the option External DC, the LNB voltage must be disconnected to charge the internal accumulator via this socket. Otherwise, the internal accumulator will not be charged during LNB operation.

# Sat Operation

## DiSEqC menu

With the MSK 33, DiSEqC commands can be sent (TX) and received (RX). The code words –framing, address, command, data- are displayed on the screen in the upper RX display field for received DiSEqC commands and in the lower TX display field for transmitted DiSEqC commands. Two additional display fields are available for the explanation of the DiSEqC commands. The DiSEqC code words can be entered-in and edited in hexcode.

### RX assessment

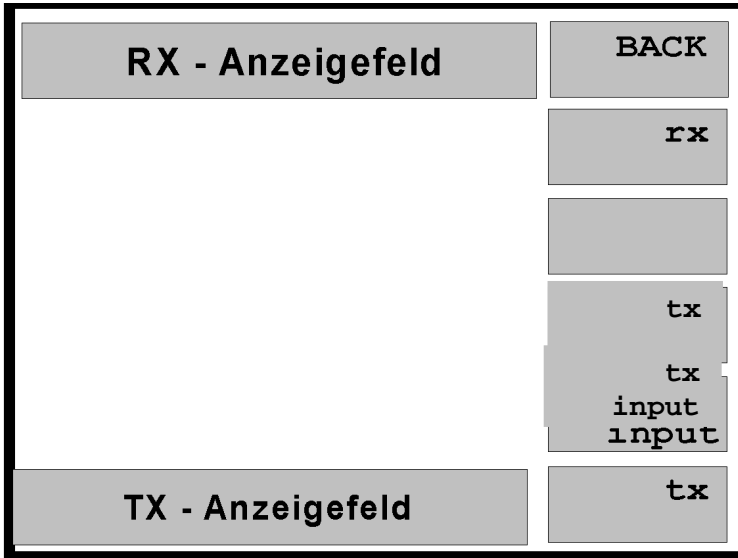

After pressing the appropriate key, the field lights up yellow for ca. 3 seconds. During this time, DiSEqC commands can be received and assessed. The display of the received DiSEqC command appears in the RC display field.

### Transmitting and receiving a DiSEqC command (TX + RX)

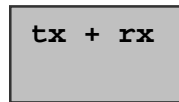

The set DiSEqC command in the TV display field is transmitted after pressing this button.

Afterwards, the MSK 33 switches to reception, in order to assess a sent back DiSEqC command, and the RX field lights up yellow (only for DiSEqC systems). For DiSEqC 2.0 systems, confirmation will not be sent back.

### Sending a DiSEqC command (TX)



After pressing this button, the set DiSEqC command in the TX display field is transmitted.

(In the COPY menu, various pre-programmed DiSEqC commands can be called up under „recall 85...90“)

### Entry of the hex numbers

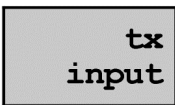

Calls up a submenu for entering the DiSEqC command.

### RX display field

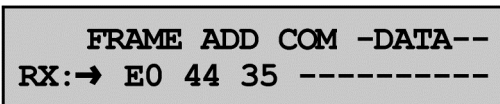

The received DiSEqC command is represented in the RX display field.

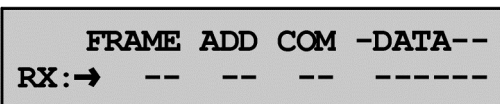

If no DiSEqC command is received, the display shown on the left appears.

# Sat Operation

## Submenu for entering DiSEqC commands

This submenu is called up by pressing the button „tx input“ in the DiSEqC menu.

|                               |          |
|-------------------------------|----------|
| <b>! Back with key ENTER!</b> | <b>A</b> |
|                               | <b>B</b> |
|                               | <b>C</b> |
| <b>Anzeigefeld A</b>          | <b>D</b> |
| <b>Anzeigefeld B</b>          | <b>E</b> |
| <b>TX - Anzeigefeld</b>       | <b>F</b> |

### Entry

The hex number, where the cursor is positioned, is displayed and flashes. This hex number can be edited with the numerical button field (1-9), with one of the softkey buttons (A to F) or with the buttons ▲ and ▼. The switch to the next character occurs with the cursor buttons, ◀▶. The four code words - Framing (FRAME), Address (ADD), Command (COM) and Data (DATA) – are located in abbreviated form above the appropriate hex codes. Press the ENTER button to exit the menu.



Refer to the technical appendix of this operating manual for an overview of the DiSEqC commands.

### TX display field

|                |            |            |                |
|----------------|------------|------------|----------------|
| <b>FRAME</b>   | <b>ADD</b> | <b>COM</b> | <b>-DATA--</b> |
| <b>TX:← E0</b> | <b>44</b>  | <b>35</b>  | <b>-----</b>   |

In the TX display, the DiSEqC commands can be edited, which are transmitted from the MSK 33 to another DiSEqC unit. The buttons, ◀ and ▶, are used here as cursor buttons. With the buttons, ▲ ▼, the hex code can be gradually increased or decreased.

### Display field A

|                               |
|-------------------------------|
| <b>E0 Command from master</b> |
|-------------------------------|

In this display field, the DiSEqC command, which is given in the TX display field, is displayed:

### Display field B

|   |
|---|
| <b>No reply required<br/>first transmission</b> |
|---|

In this display field, a brief explanation of the selected DiSEqC command is displayed.

|                              |
|------------------------------|
| <b>No framelist</b><br>----- |
|------------------------------|

If a DiSEqC command is entered-in , which is not listed in the MSK 33, this display will appear.

# Sat Operation



Example

## Entering and transmitting a DiSEqC command

|                               |          |
|-------------------------------|----------|
| <b>! Back with key ENTER!</b> | <b>A</b> |
|                               | <b>B</b> |
|                               | <b>C</b> |
|                               | <b>D</b> |
| <b>14 Switcher</b>            | <b>E</b> |
|                               | <b>F</b> |
| <b>FRAME ADD COM -DATA-</b>   | <b>F</b> |
| <b>TX: ← E0 14 22 -----</b>   |          |

Assume you want to enter-in and send the DiSEqC command E0 14 22:

Here, open the DiSEqC menu. Press the button, „tx input“. The cursor flashes in the lower left-hand corner in the TX field. Enter in the first digit of the hex number with the softkey button „E.“ Enter in the digits, 0 14 22, with the numerical buttons. The figure shows, how the menu should now look like. Press ENTER to return to the DiSEqC menu. The given DiSEqC command is transmitted by pressing the button, „tx.“

## Simple DiSEqC

By repeatedly pressing the second softkey button, you access the Simple DiSEqC menu. Also here, respective commands can be sent.

Simple DiSEqC offers two control possibilities: a continuous 22 kHz tone burst and an uninterrupted 22 kHz data burst.

data  
burst

Selection of the data burst

tone  
burst

Selection of the tone burst

tx

Transmitting the selected bursts



## UFOMicro DiSEqC menu

### General information

In the UFOMicro mode, one or various head stations EXU 544 in a Kathrein in-house system can be tested. The test can be carried with or without a KATHREIN satellite receiver from the 400 series or higher.

The following functions and features are available:

1. Simulates the basic function of a Kathrein satellite receiver.  
Transmitting of „virgin call for address“, „call for address“, „program command“, „poweron/off“ – in consideration of the allocated pages of the collision protection.
2. Simulation of max. 12 UFD receivers in conjunction with the installed UFOµ-head stations. 12 pre-programmed factory settings can be called up.
3. Monitoring (watching and recording) of DiSEqC commands, which are transmitted between the UFOMicro head stations and the UFD receivers for a specific period of time.
4. Display of the respective receiver 01...12 with the head end reply, receiver address, remote IF and the collision protections pages (t0, t1, t2 in ms).  
Analogue picture assessment of the remote IF, which is allocated from the head station or in conjunction with the spectrum representation in the spectrum menu.
5. Antenna socket testing ( testing the disconnection function).

### Display fields

#### RX field

|    | FRAME | ADD | COM | -DATA- |
|----|-------|-----|-----|--------|
| RX | 0     | E2  | 10  | 33     |
|    |       |     |     | -----  |

In this field, the telegrams, which are received from the current head station, are displayed.

In the case of activated monitoring, a maximum of five telegrams are recorded. The respective displayed telegram is indicated with the no. RX: 0 ..... RX:4. Flashing signalises the beginning of the recording. At the end of the recording, the last recorded telegram is displayed.

#### Status field

In the centre of the screen, the status of the head station and the registered receiver as well as the transmission error and the transmission status are displayed.

The following messages are possible:

|                                 |  |
|---------------------------------|--|
| <b>!no acknowledge EXU544!</b>  | Transmission error EXU ..... MSK33                                       |
| <b>! acknowledge EXU544 !</b>   | No transmission error  |
| <b>!Rec. -- not registered!</b> | Receiver is not yet registered in the head station                       |
| <b>Rec. -- - registered -!</b>  | Receiver registered in the head station                                  |
| <b>!Rec. -- -- Stand-by --!</b> | Receiver is registered but in standby                                    |
| <b>UFOu + Bus-Control</b>       | MSK 33 considers the collision protection, INT33 is equipped             |
| <b>UFOu without Bus-Control</b> | MSK 33 does not consider the collision protection, INT33 is not equipped |

# Sat Operation

## Receiver field

| Rec  | adr | r-zf | t0 | t1 | t2 | st |
|------|-----|------|----|----|----|----|
| >02< | 244 | 1200 | 20 | 12 | 4  | 2  |

In the receiver field, the setting status of the receiver 01...12 simulated by the MSK 33 is displayed.

Refer to the example to the left:

The receiver 2 is registered in the head station with the address 244. The remote IF is 1200 MHz.

The collision pages are t0 = 20 ms, t1 = 12 ms and t2 = 4 ms. The status of the receiver 2 is „registered.“

## TX field

|    | FRAME | ADD | COM | DATA   |
|----|-------|-----|-----|--------|
| TX | E2    | 00  | F2  | 1390-- |

In the TX-field, the currently selected telegram of the respective receiver, 01...12, is displayed with the individual DiSEqC bytes and represented in combination with the individual DiSEqC commands.

The example shows: FRAME is E0 according to the programme commando (PrgCom). Address ADD is 00 (is reserved). Polarisation byte COM F2 complies with the selected polarisation and Sat planes. DATA complies with the set Sat IF in MHz.

## Operating the menus

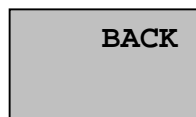

Exit the DiSEqC menu.

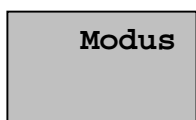

In the set UFO $\mu$  DiSEqC mode, the available remote IF frequency is adopted. In this case, the MSK 33 remains in the the UFO $\mu$  DiSEqC mode after exiting this menu and is still connected with the head end allowing standard measurements to be carried out. By repeatedly pressing this softkey (ring counter), select the UFO $\mu$  DiSEqC menu.

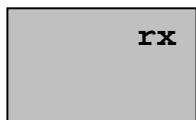

By quickly pressing this softkey, the monitoring function is switched on, in which the transmitted DiSEqC commands are recorded for a time period of up to 20 seconds. A maximum of 5 events (RX0...RX4) with respectively up to 6 bytes (Frame, Add, Com, Dat1, Dat2, Dat3) can be recorded between the head end and the available satellite receivers. During the recording, the command are displayed in the second line of the RX field by flashing.

The recording is automatically completed or prematurely cancelled by pressing down the softkey for a longer time.

With the buttons,  $\blacktriangle$  and  $\blacktriangledown$ , the individual telegrams, RX 0...RX4, in the second line can be called up.

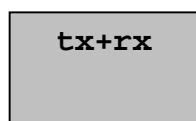

With the aid of this softkey, the selected telegram in the lower TX field is transmitted. If a message from the head station follows, the reply message is displayed in the RX field. The reply message is accordingly taken over in the receiver field, e.g. the remote IF.

By repeatedly pressing this softkey (ring counter), the DiSEqC telegram Virgin-Call-For-Address, Call-For-Address, Program-Command or Switch-Off is selected.

The respective telegram code is displayed in the TX field.

With this softkey, the cursor buttons,  $\blacktriangle\blacktriangledown$  and  $\blacktriangleleft\blacktriangleright$ , are switched on.

Independent from the selected telegram, different editing fields can be selected with the button,  $\blacktriangleleft$  or  $\blacktriangleright$ . The selected fields are framed with arrows.

In the case of a programme command, the respective DiSEqC command, COM or DATA, can be edited. Select the editing field using the cursor button,  $\blacktriangledown$  or  $\blacktriangle$ .

In the COM field, the polarisation byte, F0...FF, (horizontal/vertical/high/low) are selected with the aid of the cursor button,  $\blacktriangle$  or  $\blacktriangledown$ , and displayed in the softkey.

In DATA field, the Sat IF can directly changed in MHz via a numerical entry.

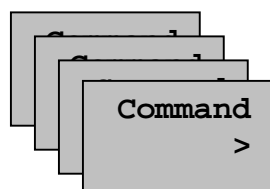

# Sat Operation

The receiver no. is edited by calling up ◀ of the receiver no. –of the field with the aid of the button, ▲ or ▼.

## Installation of a UFO $\mu$ unit EXU 544 in conjunction with the MSK 33

In this arrangement, the MSK 33 is connected to the output of the head station and simulates up to 12 Kathrein receivers. A registration of the MSK 33 receiver (depending on the number of EXU 544 in the system segment) should be carried out in the head stations.

The installation should be carried out as follows:

1. Bring the MSK 33 into the UFO $\mu$  mode by selecting the softkey button 2.
2. Install the EXU 544 according to the Kathrein description 273433 and bring it into reset status.
3. Select further receivers with the MSK 33 beginning with 01.
4. Bring the MSK into the position „V-call addr“ (Virging-Cal For Address) with the aid of the „Command“ button and send it to the head station by pressing the softkey, „tx + rx.“ The head station then sends back the registered address, remote IF, collision protection pages and the status message „Rec – registered!“ for the receivers.
5. Bring the MSK 33 into the position „PrgCom“ (programme command) with the „Command“ button and send it to the head station with the softkey, „tx + rx.“ If required, the alignment of the satellite dish can now be carried out. An analogue picture assessment is possible.
6. Further receivers can be registers and set in the head station in the same sequence described above under point 3, 4, 5.
7. Available remote IF frequencies can be displayed by calling up the receivers no. 01...12 (analogue picture) or in the spectrum menu.

# Sat Operation

## V-SEC menu

By repeatedly pressing the second softkey, you access the V-SEC menu. V-SEC simply offers the possibility to send a data item. It gives no reply.

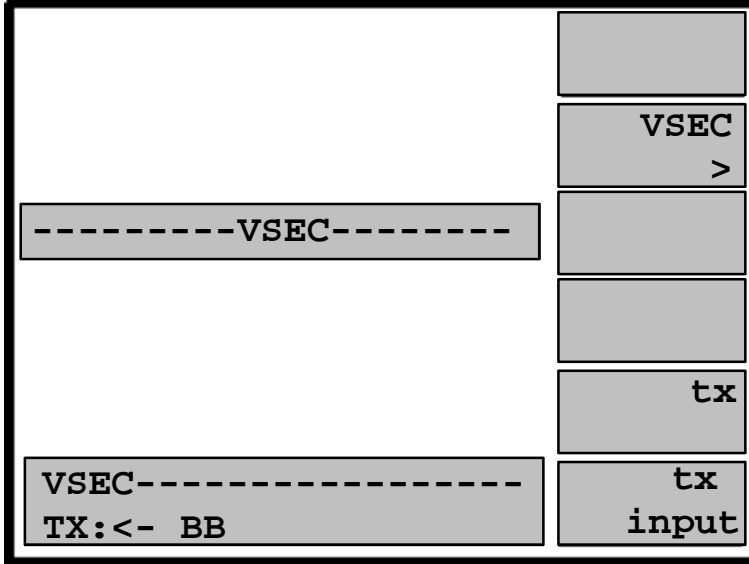

### Entering the hex numbers

tx  
input

Call up a submenu by entering in the hex numbers.

This hex number can be set with the numerical button field (0 to 9) or with the softkey (A to F).

### Sending a V-SEC command (TX)

tx

The set V-SEC command in the TX display field is sent after pressing this button.

# Sat Operation

## Initial ANALOG-menu

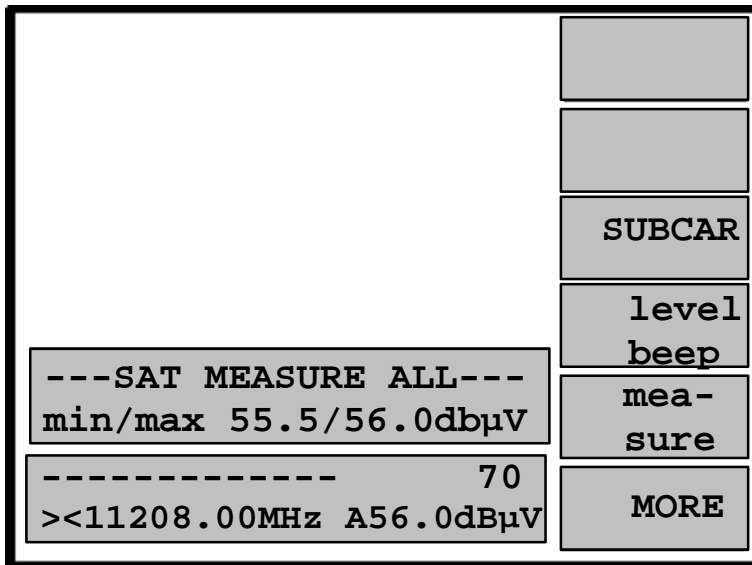

With this softkey, the Sat menu is called up.

**Calling up the sound subcarrier menu**

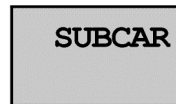

**Level-dependent acoustic signal**



In the function, level beep,“ an acoustical signal is produced, whose pitch is proportional to the

received signal level. With it, it is possible to optimally align the receiving antenna to a transmitter.

In this menu, the receiving frequency can be changed using the cursor buttons, ◀▶.

## Level measurement ANALOGUE

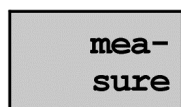

**Calling up the level measurement ANALOGUE as well as minimal and maximal level measurement.**

You can now measure the level of the analogue satellite signals. As long as this measurement function is called up, the MSK 33 measures the minimal and maximal level. This measurement function serves for monitoring the check points for level fluctuations. Even after exiting the menu, the MSK 33 stays set on ANALOGUE reception.

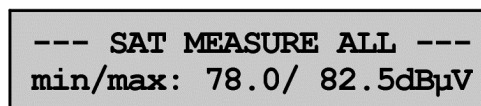

The following display appears on the screen, when the button „measure“ is pressed: Display of the minimal level 78.0 dbµV and maximal level 82.5 dBµV.



Display Sat frequency, analogue reception „A“ and level. Both arrows in front of the transponder frequency display simplifies the precise tuning to the middle frequency.



**An „A“ in front of the level display means, that the MSK 33 is set to analogue reception. Even after the menu is closed, the MSK 33 remains set to ANALOGUE reception.**

For level measurement for digital satellite signals, the MSK can be switched over to the digital menu, refer to the respective section.



Calls up the second submenu ANALOGUE.

# Sat Operation

## Second ANLAOG menu

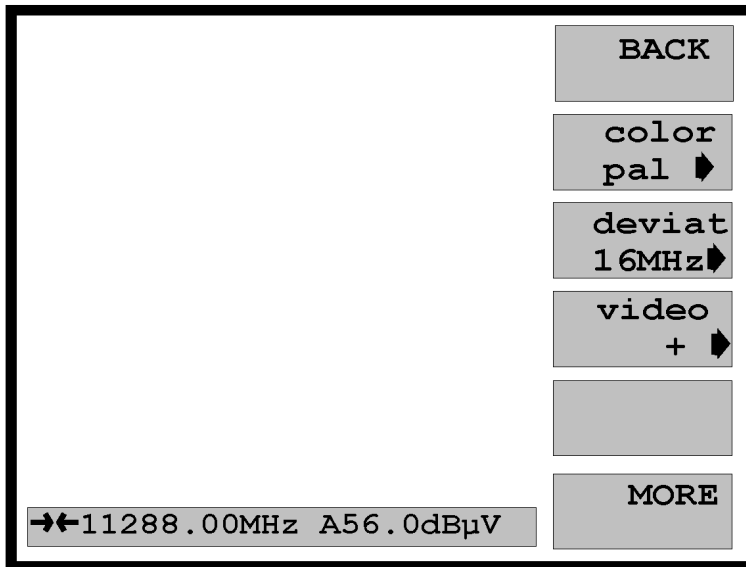

The Sat menu is called up.

### Selecting the colour standards PAL, SECAM and NTSC



### Selecting the video hub

16 MHz for ASTRA reception, 25 MHz for EutelSat reception.



### Video polarity



Switch-over of the video polarity between positive and negative.

A „+“ stands for positive video signal.

A „-“ stands for negative video signal.



Return to the first submenu ANALOG.

# Sat Operation

## Sat subcarrier menu

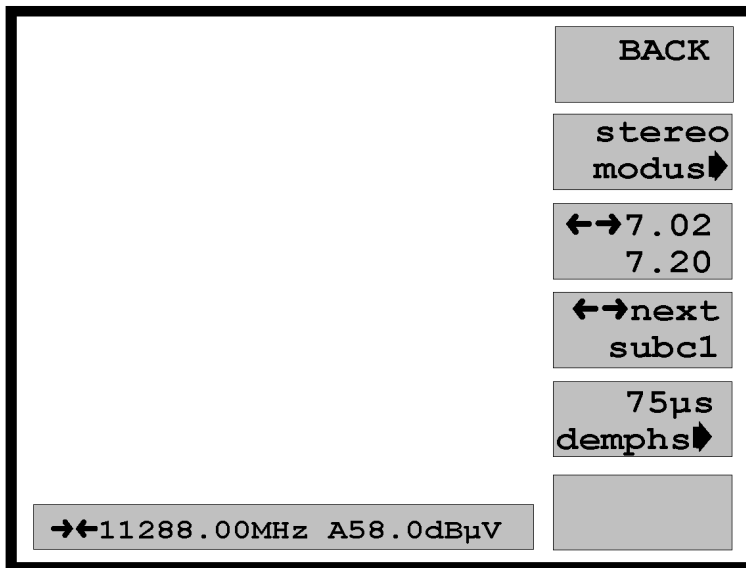

Calls up the first ANALOG menu

### Selecting the subcarrier reception type (refer to the subcarrier table)

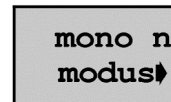

**MONOn:** Audio subcarrier reception (narrow bandwidth)

**MONOw:** Main audio subcarrier reception (wide bandwidth)

**STEREO:** The two audio carriers are demodulated, which were set in the field audio carrier frequency. The frequency spacing between the two audio carriers is always 180 kHz. The selected audio signal always lies on the Scart and headphone socket.

### Audio carrier frequency

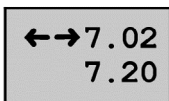

Display of the set audio carriers. The audio carriers can be changed from 5.8 MHz to 8.64 MHz in 10 kHz increments. Use the cursor buttons, ◀▶, to change the value.

### Audio carrier setting

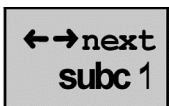

Thirteen different preset audio carrier frequencies can be selected (refer to audio carrier table).

### Setting of the de-emphasis



Three settings are possible: 50 µsec, 75 µsec and J17 (refer to audio carrier table).

# Sat Operation

## Audio carrier tables for the satellite reception

The reception parameters – audio frequency, audio carrier bandwidth, de-emphasis – are linked to each other by the software, so no operation error can result from calling up an incorrect parameter.

| Audio carrier table for reception type:<br><b>MODUS STEREO</b> |                      |                      |                      |                      |
|--|----------------------|----------------------|----------------------|----------------------|
|  | ↔next<br>subc 1      | ↔next<br>subc 2      | ↔next<br>subc 3      | ↔next<br>subc        |
| Audio carrier frequency  | 7.02 MHz<br>7.20 MHz | 7.38 MHz<br>7.56 MHz | 7.74 MHz<br>7.92 MHz | 8.10 MHz<br>8.28 MHz |
| De-emphasis  | 75 µsec              | 75 µsec              | 75 µsec              | 75 µsec              |

| Audio carrier table for reception type:<br><b>MODUS MONO w</b> |                         |                      |
|--|-------------------------|----------------------|
|  | Audio carrier frequency | De-emphasis optional |
| ↔next subc 1   | 5.8 MHz                 | J 17 or 50 µsec      |
| ↔next subc 2   | 6.5 MHz                 | J 17 or 50 µsec      |
| ↔next subc 3   | 6.65 MHz                | J 17 or 50 µsec      |
| ↔next subc 4   | 7.02 MHz                | J 17 or 50 µsec      |
| ↔next subc 5   | 7.20 MHz                | J 17 or 50 µsec      |
| ↔next subc 6   | 7.38 MHz                | J 17 or 50 µsec      |
| ↔next subc 7   | 7.56 MHz                | J 17 or 50 µsec      |
| ↔next subc 8   | 7.74 MHz                | J 17 or 50 µsec      |
| ↔next subc 9   | 7.92 MHz                | J 17 or 50 µsec      |
| ↔next subc 10  | 8.10 MHz                | J 17 or 50 µsec      |
| ↔next subc 11  | 8.28 MHz                | J 17 or 50 µsec      |
| ↔next subc 12  | 8.46 MHz                | J 17 or 50 µsec      |
| ↔next subc 13  | 8.64 MHz                | J 17 or 50 µsec      |

| Audio carrier table for reception type:<br><b>MODUS MONO n</b> |                         |             |
|--|-------------------------|-------------|
|  | Audio carrier frequency | De-emphasis |
| ↔next subc 1   | 5.8 MHz                 | 75 µsec     |
| ↔next subc 2   | 6.5 MHz                 | 75 µsec     |
| ↔next subc 3   | 6.55 MHz                | 75 µsec     |
| ↔next subc 4   | 7.02 MHz                | 75 µsec     |
| ↔next subc 5   | 7.20 MHz                | 75 µsec     |
| ↔next subc 6   | 7.38 MHz                | 75 µsec     |
| ↔next subc 7   | 7.56 MHz                | 75 µsec     |
| ↔next subc 8   | 7.74 MHz                | 75 µsec     |
| ↔next subc 9   | 7.92 MHz                | 75 µsec     |
| ↔next subc 10  | 8.10 MHz                | 75 µsec     |
| ↔next subc 11  | 8.28 MHz                | 75 µsec     |
| ↔next subc 12  | 8.46 MHz                | 75 µsec     |
| ↔next subc 13  | 8.64 MHz                | 75 µsec     |



# Digital Measurements

## SAT DIGITAL menu

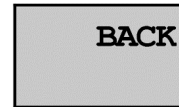
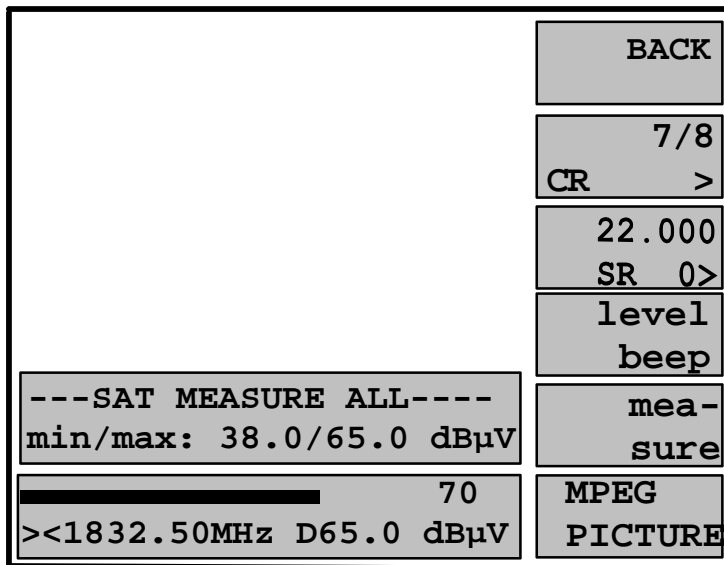

Calls up the previous menu.

### Level-dependent acoustic signal



In the function, "level beep," an acoustic signal is generated, whose pitch is proportional to the received signal level. With this signal, it is possible to optimally align the receiving antenna to a transmitter.

In this menu, the receiving frequency can be changed using the cursor buttons, ◀▶.

### Convulsion code for Sat measurement

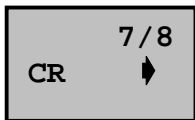

With this button, the convolution code is set for demodulating the QPSK signals from 1/2 to 8/9. The setting is adopted for the constellation analysis.

### Symbol rate entry

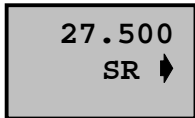

You can choose between four preset symbol rates for correct level measurement of digital signals ( in SAT mode: 22,000; 27,500; 20,000 and 27,500). It also possible to change the preset symbol rates by numerical entry. In the SAT area, symbol rates can be programmed from 0.5 ...32 Ms. This programming is adopted at the constellation analysis. With the [MHz] button, the entry is completed.

The correct symbol rate must be set for proper level measurement of signals!



### MPEG decoder menu (OPTION)

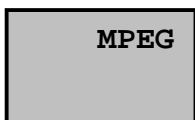

In this function, the PAL list (programme association table) and the respective PIDs (packet identifier) of the transport stream are displayed. The desired programmes can be selected in this menu and represented on the screen (refer to „MPEG decoder“).



# TV Operation

## TV menu

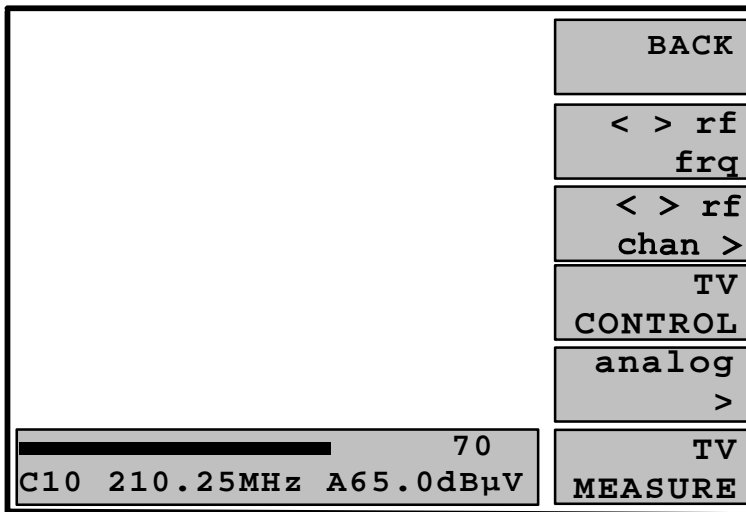

Calls up the main menu

### Frequency entry of 44.75-867.2 MHz / DVB-T / BIII / UHF

The field lights up yellow as soon as the softkey is pressed. Now, the frequency can be entered-in with numerical buttons, „0...9,“ and „MHz“ or changed with the cursor buttons, ◀▶, in 50 kHz increments. The frequency is displayed in the lower left-hand corner of the screen.

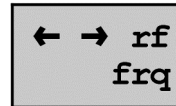

### Mid-channel display

If a large „C“ or „S“ appears on the screen, the frequency is set to mid-channel.



*Receiving frequency is optimally set*



*Frequency is not optimally tuned*

The entered frequency is not in mid-channel of the respective RF standard, if a small „c“ or „s“ does not appear.

## Entering in a channel

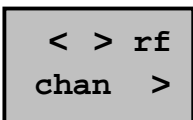

This field lights up yellow, as soon as the softkey is pressed. The channel can be entered with two digits with the numerical buttons, „0...9“ or changed with the cursor buttons, ◀▶.



A large „C“ appears in front of the channel display, when a channel is optimally tuned.

## Entering a special channel

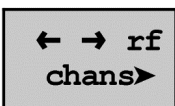

By pressing the softkey once more, „chans“ appears in the menu field. A special channel not now be entered-in.



For tuning to a special channel, a large „S“ appears in front of the channel display.

## Selecting analogue, DVB-C and DVB-T measurement

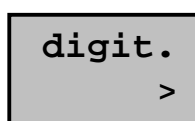
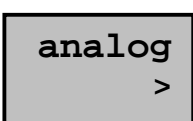

## Calling up the menu TV control



In this menu, all remotely controlled parameters such as remote power feeding voltage, 22 kHz, DiSEqC, tone burst (Simple DiSEqC) and V-SEC are set.

# TV Operation

## TV control menu

### 22 kHz control signal

|                       |                 |
|-----------------------|-----------------|
| LNB: U= 0.0 V I= 0 mA | BACK            |
|                       | 22 kHz<br>off>  |
|                       | 14.0V<br><>off> |
|                       | 18.0V<br><>off> |
|                       |                 |
|                       | DiSEqC<br>VSEC  |

22kHz  
on>

The field lights up yellow, as soon as the softkey is pressed. The switchable 22 kHz signal over superimposes the supply voltage. By pressing the button once more, the 22 kHz signal is disconnected

### LNB supply voltage

(Remote power supply)

14.0V  
on>

The field lights up yellow, as soon as the softkey is pressed. The supply voltage for the vertical polarisation 14.0 V is now switched on. For control, the LED above the RF input socket lights up. The

voltage value can be entered in with the buttons, 0...9, or changed in the range from 10 V to 20 V with the cursor buttons, ◀▶. By pressing the button once more, the LNB supply voltage is disconnected again.

### Remote supply voltage

18.0V  
on>

See above.



The remote supply voltage is  
- disconnectable= 0V  
- changeable from 10...20 V in 0.1 V increments  
- short-circuit proof max. current 500 mA

LNB: U = 14,6V I = 181mA

This field displays the current drain (I = 181 mA) and the supply voltage (14.6 V) of the LNB.

### Checking the supply voltage in a remotely fed system

Switch the remote power feeding voltage of the MSK 33 to „OFF.“ Connect the system with the MSK 33 (RF input socket with antenna socket). You can now read on the screen the output voltage of the remotely fed-in unit in the checked system

### Calling up the menu DiSEqC / VSEC

DiSEqC  
VSEC

In this menu, all DiSEqC control possibilities can be set (refer to the respective section).

### TV-DiSEqC /VSEC menu

The menu explanations are found in the respective section.

# TV Operation

## Analogue menu



Calls up the TV menu

### Selecting the standard

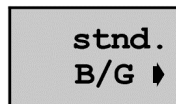

With this softkey, the following standards can be selected: B/G, D/K, I, L, M, M – jap. (Japan) and N. Refer to the audio carrier table.

In this menu, the channel setting can be changed using the cursor buttons, ◀▶. In the RP menu, the receiving frequency can be changed in this manner.

| Audio carrier table for TV reception   |                       |                      |                                  |               |
|--|-----------------------|----------------------|----------------------------------|---------------|
| The given audio carrier frequencies are based on the video audio carrier spacing |                       |                      |                                  |               |
| Standard   | Audio carrier 1 (sc1) | Audio carrier (sc 2) | Audio carrier (1 +2 sc)          | NICAM (nicam) |
| B/G  | 5.50 MHz              | 5.74 MHz             | sc 1: 5.50 MHz<br>sc 2: 5.74 MHz | 5.85 MHz      |
| L  | 6.50 MHz (AM)         |                      |                                  | 5.85 MHz      |
| D/K  | 6.50 MHz              | 6.26 MHz             | sc 1: 6.50 MHz<br>sc 2: 6.26 MHz | 5.85 MHz      |
| I  | 6.00 MHz              |                      |                                  | 6.552 MHz     |
| M  | 4.50 MHz              | 4.72 MHz             | sc 1: 4.50 MHz<br>sc 2: 4.72 MHz |               |
| M (Japan)  | 4.50 MHz              |                      |                                  |               |
| N  | 4.50 MHz              |                      |                                  |               |

### Selecting the audio carriers

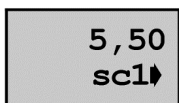

By pressing the button, the MSK 33 can be set to the following reception types:

- Audio carrier 1 (sc1)
- Audio carrier 2 (sc2)
- Stereo (sc1 + sc2)
- NICAM (nicam)

### Level-dependent acoustic signal



In the function, „level beep,“ the acoustic signal is generated, whose pitch is proportionate to the received signal level. With this, it is possible to optimally align the receiving antenna to a transmitter.

### Carrying out measurements

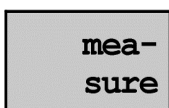

By pressing the button, the MSK 33 is set to analogue reception and measures the following values:

- Audio carrier spacing of TT1 (sc1) and TT2 (sc2)
- Nicam audio carrier spacing (if available)
- Nicam bit error rate (BER)

## TV Operation

- Minimal and maximal levels (min./max.)
- Level measurement ANALOGUE

The respective following displays appear on the screen, when the button, „measure“ is pressed.

### Measuring audio carrier spacing

```
----TV MEASURE ALL ---  
SC1/SC2: -13.5 / -19.5dB
```

*Audio carrier 1: -13.5 dB*  
*Audio carrier 2: -19.5 dB*

### Measuring the Nicam audio carrier spacing and bit error rate

```
NICAM:      -18.5 dB  
BER   :      5.6E-06
```

*Nicam audio carrier spacing 1: -18.5 dB*  
*Nicam bit error rate: 5.6E-06 (5.6<sup>-6</sup>)*

### Measuring the min./max. level

In the display, the following values are represented:

*Minimal level: 7.5 dB $\mu$ V*

*Maximal level: 2.5 dB $\mu$ V*

In this function, the MSK 33 measures the minimal and the maximal level, test points can follow to level fluctuations.

```
min/max: 77.5 / 82.5 dB $\mu$ V
```

### Measuring the current level

The following values are displayed in the display:

Channel: *S16* (special channel)

Frequency: *266.25 MHz*

Analogue reception: *A*

Current level: *79.5 dB $\mu$ V*



An „A“ in front of the level display means, that the MSK 33 has be set to analogue level measurement. Even after exiting the menu, the MSK 33 stays set to ANALOGUE reception.

For level measurement of digital TV signals, it can be switched over the digital reception in the DIGITAL menu (refer to the respective section).

### Selecting the colour standards PAL, SECAM and NTSC

```
color  
pal ▸
```

# TV Operation

## TV DIGITAL menu

### DVB-C

|                         |                 |
|-------------------------|-----------------|
|                         | BACK            |
|                         | QAM64<br>mode > |
|                         | 6.900<br>SR 1>  |
|                         | level<br>beep   |
| ----TV MEASURE ALL----  | mea-<br>sure    |
| min/max: 38.0/65.0 dBµV | MPEG            |
| 70                      | PICTURE         |
| S32 394.00MHz D65.0dBµV |                 |

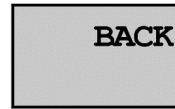

Calls up the previous menu

### Level-dependent acoustic signal



In the function, "level beep," a acoustic signal is generated, whose pitch is proportional to the received signal level. With this

signal, it is possible to optimally align the receiving antenna to a transmitter.

In this menu, the receiving frequency can be changed using the cursor buttons, ◀▶. In the RP menu, the receiving frequency can be changed in this manner.

### Selecting demodulation for DVB-C measurement

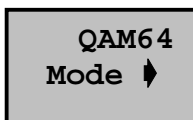

With this button, the type of demodulation, QAM64, QAM128 or DOCSIS QAM64 (Softkey designation = DOC64 Mode) is selected. The setting is taken over for the constellation analysis.

### Symbol rate entry

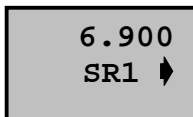

For correct level measurement of digital signals, you can choose between 4 pre-set symbol rates (In DVB-C mode: 6,900; 6,111; 6,952 and 6,875.). It is also possible, to change the preset symbol rates by numerical entry. In the DVB-C range, symbol rates can be programmed from 0.5...7.2 Ms. This programming is taken over for the constellation analysis. With the [MHz] button, the entry is completed.

For correct level measurement of signals, the correct symbol rate must be set!



# TV Operation

## DVB-T (optional)

|                         |                 |
|-------------------------|-----------------|
|                         | BACK            |
|                         | chBW<br>8 MHz > |
|                         | 22.000<br>SR 0> |
|                         | level<br>beep   |
| ----TV MEASURE ALL----  | mea-<br>sure    |
| min/max: 38.0/65.0 dBµV | MPEG            |
| 70                      | PICTURE         |
| C21 474.00MHz D65.0dBµV |                 |

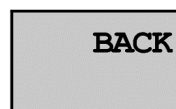

Calls up previous menu.

### Level-dependent acoustic signal



In the function, „level beep,“ a acoustic signal is generated, whose pitch is proportional to the received signal level. With this signal, it is possible to optimally align the receiving antenna to a transmitter.

In this menu, the receiving frequency can be changed using the cursor buttons, ◀▶.

### Selecting channel bandwidths

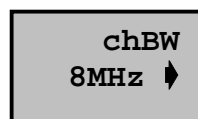

For correct level measurement of digital signals, you can choose between 3 channel bandwidths (6, 7 and 8 MHz). This programming is taken over for the constellation analysis.



For correct level measurement of the signals, the correct bandwidth must be set!

### MPEG decoder menu (OPTION)

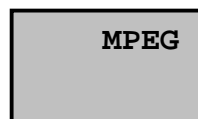

In this function, the PAT list (Program Association Table) and the respective PIDs (Packet Identifier) of the transportation stream are displayed. The desired programmes can be selected in this menu and represented on the screen (refer to „MPEG decoder“).



# Return Path IF Menu

## Return path IF menu

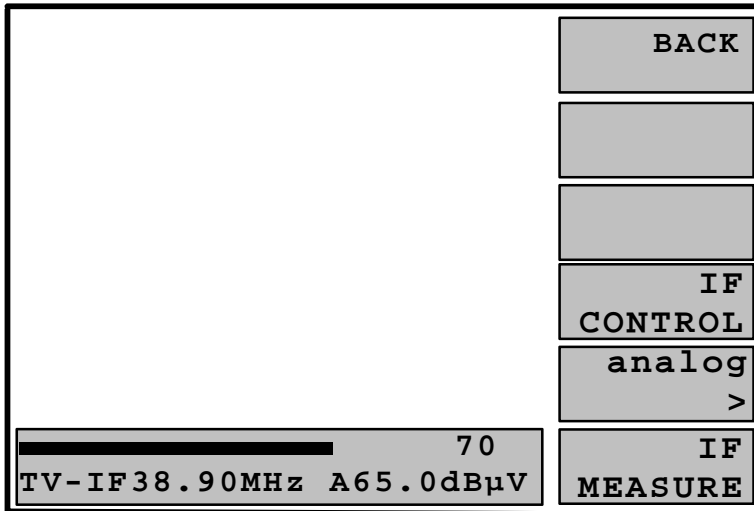

In this menu, the video carriers -each according to optional assignment- can be measured on IF levels (38.9 MHz analogue and 36.15 MHz digital) or on the entire return path area (Optional return path card) from 4 MHz to 80 MHz.

*Each according to assignment, the MSK 33 answers with the IF menu or the optional return path menu (refer to star marking).*

### Entering a frequency of 7.00 MHz up to 80.00MHz\*

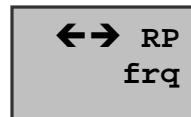

The return path frequency can be entered in with the numerical button, „0...9,“ with the cursor buttons, ◀▶, in 50 kHz increments. The frequency is displayed in the lower left-hand corner.

### Inverting the RF spectrum\*

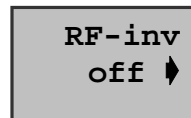

By pressing this button, the RF spectrum can be inverted. This means, that the video and audio carrier for digital modulation, the I and Q vectors can be exchanged.

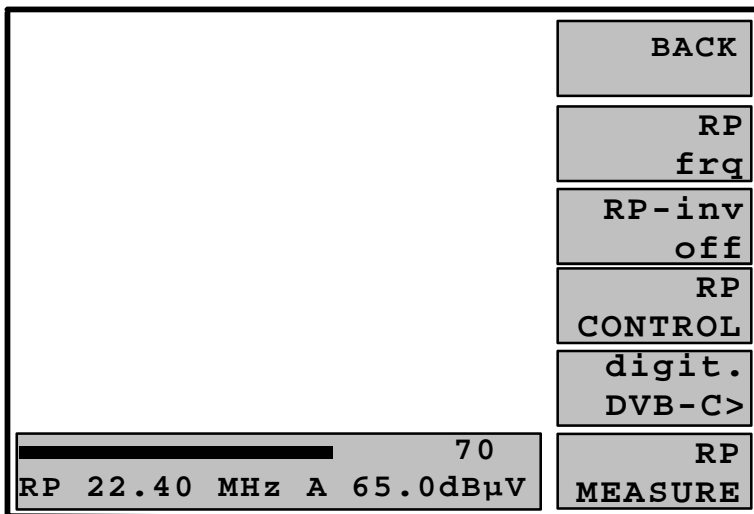

## ANALOG Menu

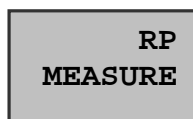
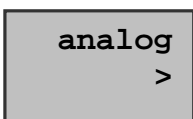

Access the analogue menu with the buttons, “analog” and “RP MEASURE.” In this menu, settings and measurements of analogue signal are possible (For further information, refer to the TV Analog menu).

## DIGITAL menu

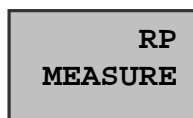
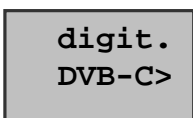

Access the digital menu with the buttons, “digit. DVB-C” and “RP MEASURE”. In this menu, settings and measurements of the DVB-C signals are possible. IF demodulation of DVB-T signals is also possible (For further information, refer to the TV digital menu).

## IF CONTROL menu (RP-CONTROL\*)

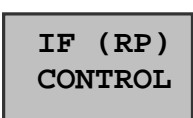

In this menu, all remotely controlled parameters, such as remote feeding voltage, 22 kHz, DiSEqC, tone burst (simple DiSEqC), V-SEC, can be set (for further information, refer to TV menu).

# Return Path IF Menu

## ANALOG menu

In this menu, all settings for the measurement of the analogue IF signal with the frequency of 38.9 MHz can be made.

The screenshot shows the Return Path IF Menu with the following elements:

- BACK** (top right softkey)
- stnd. b/g** (second softkey)
- Display: `---- TV MEASURE ALL ----`
- Display: `SC1/SC2:----.- /-----.-dB`
- Display: `NICAM : ---- dB`
- Display: `BER :--.-e----`
- Display: `min/max:---.-/----.-dBμV`
- Display: `■■■■ ■■■■ ■■■■ ■ 70`
- Display: `TVIF 38.9MHz A 56.0dBμV`
- 5.50 sc1** (third softkey)
- level beep** (fourth softkey)
- mea- sure** (fifth softkey)
- color pal** (sixth softkey)

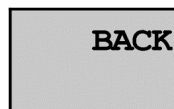

Calls up the RP(IF) menu

### Selecting the standard

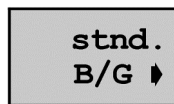

With this softkey, the following standards can be selected: B/G, D/K, I, L, M, M - jap (Japan) and N. See also audio carrier table.

**Audio carrier table for IF reception**

The given audio carrier frequencies are based on the respective video-audio carrier spacing.  
 The video carrier frequency is 38.9 MHz without the return path option for each standard and can not be changed.  
 With equipped return path option, the video carrier frequencies\* are freely selectable.

| Standard  | Video carrier frequency * in IF position | Audio carrier1 (sc1)        | Audio carrier2 (sc2) | Stereo (sc1+sc2)                 | NICAM (nicam)            |
|-----------|--|-----------------------------|----------------------|----------------------------------|--------------------------|
| B/G       | 38.9 MHz                                 | -5.50 MHz                   | -5.74 MHz            | sc1: -5.50 MHz<br>sc2: -5.74 MHz | -5.85 MHz                |
| L         | 32.7 MHz, (38.9 MHz, 39.2 MHz)           | +6.50 MHz AM<br>(-6.50 MHz) |                      |                                  | +5.85 MHz<br>(-5.85 MHz) |
| D/K       | 37.0 MHz, 38.0 MHz, 38.9 MHz             | -6.50 MHz                   | -6.26 MHz            | sc1: -6.50 MHz<br>sc2: -6.26 MHz | -5.85 MHz                |
| I         | 38.9 MHz, 39.5MHz                        | -6.00 MHz                   |                      |                                  | -6.552 MHz               |
| M         | 45.75 MHz                                | -4.50 MHz                   | -4.72 MHz            | sc1: -4.50 MHz<br>sc2: -4.72 MHz |                          |
| M (Japan) | 45.75 MHz, 58.75 MHz                     | -4.50 MHz                   |                      |                                  |                          |
| N         | 45.75 MHz                                | -4.50 MHz                   |                      |                                  |                          |

The display in the third field is dependent on the previously selected FS standard. By pressing the third softkey, the following audio transmissions can be chosen:

- Audio carrier 1 (sc1)
- Audio carrier 2 (sc2)
- Stereo (sc1 + sc2)
- NICAM (nicam)

### Level-dependent acoustic signal



In the function, „level beep,“ a acoustic signal is generated, whose pitch is proportional to the received signal level. With this signal, it is possible to optimally align the receiving antenna to a transmitter.

# Return Path IF Menu

## Carrying out measurements

mea-  
sure

By pressing this button, the MSK 33 is set to analogue reception and measures the following values:

- Audio carrier spacing from TT1 (sc1) and TT2 (sc2)
- Nicam audio carrier spacing (if available)
- Nicam bit error rate (BER)
- Minimal and maximal level (min./max.)

Level measurement ANALOGUE

The following displays appear on the screen, when the button, „measure,“ is pressed.

### Measurement of the audio carrier spacing

----TV MEASURE ALL ---  
SC1/SC2:-13.5/-19.5dB

Audio carrier 1: -13.5 dB  
Audio carrier 2: -19.5 dB

### Measurement of the Nicam audio carrier spacing and the bit error rate

NICAM: -18.5 dB  
BER : 5.6E-06

Nicam audio carrier spacing 1: - 18.5 dB  
Nicam audio carrier spacing: 5.6E-06 (5.6<sup>-6</sup>)

### Measurement of the min./max. level

min/max:77.5/ 82.5 dB $\mu$ V

In the display, the following values are represented:

Minimal level: 77.5 dB $\mu$ V

Maximal level: 82.5 dB $\mu$ V

In this function, the MSK 33 measures the minimal and the maximal level, so the check points can be tracked for level fluctuations.

As long as this measurement function is called up, the MSK 33 measures the minimal level and the maximal level. This measurement function serves for monitoring the check points for level fluctuations.

### Measurement of the current level

TVIF 38.9MHz A 79.5dB $\mu$ V

In the display appears:

Channel: IF

Frequency: 38.9 MHz

Analogue reception: A

Current level: 79.5 dB $\mu$ V



An „A“ in front of the level display means, that the MSK 33 has been set to analogue level measurement. Even after exiting the menu, the MSK 33 stays set to ANALOGUE reception.

For level measurement on digital IF signals, the MSK 33 can be switched-over to the digital menu (refer to the respective section).

### Selecting the colour standards PAL, SECAM and NTSC

color  
pal ▸

(the lower softkey)

# IF RP DIGITAL Menu

## DVB-C

|   |                 |
|---|-----------------|
|   | BACK            |
|   | QAM64 mode >    |
|   | 6.900 SR 0>     |
|   | level beep      |
| --- RP MEASURE ALL ---<br>min/max: 38.0/65.0 dBµV | mea-<br>sure    |
| RP 48.25MHz D65.0 dBµV                            | MPEG<br>PICTURE |



Calls up the previous menu

### Level-dependent acoustic signal



In the function, „level beep,“ a acoustic signal is generated, whose pitch is proportional to the received signal level. With this

signal, it is possible to optimally align the receiving antenna to a transmitter.

In this menu, the receiving frequency can be changed using the cursor buttons, ◀▶. The receiving frequency can be changed in this manner in the RP menu.

### Selecting demodulation for DVB-C measurement

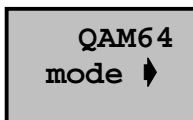

With this button, the type of demodulation, QAM64, QAM128 r DOCSIS QAM64 (Softkey designation = DOC64 mode), can be selected. The setting is taken over for the constellation analysis.

### Entering symbol rate

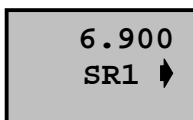

For correct level measurement of digital signals, you can choose between 4 preset symbol rates (In B-C mode: 6,900; 6,111; 6,952 d 6,875.). It is also possible to change the preset symbol rates by numerical entry. In the DVB-C range, symbol rates can be programmed from 0.5 –7.2 Ms. This programming is taken over for the constellation analysis. With the [MHz] button, the entry is completed.

For correct level measurement of signals, the correct symbol rate must be set!



### MPEG decoder menu (OPTION)

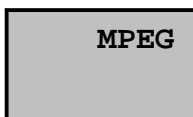

In this function, the PAT list (Program Association Table) and the respective PIDs (Packet Identifier) of the transport stream are displayed. The desired programme can be selected in this menu and displayed on the screen (see „MPEG decoder“).

# Radio Operation

## RADIO menu

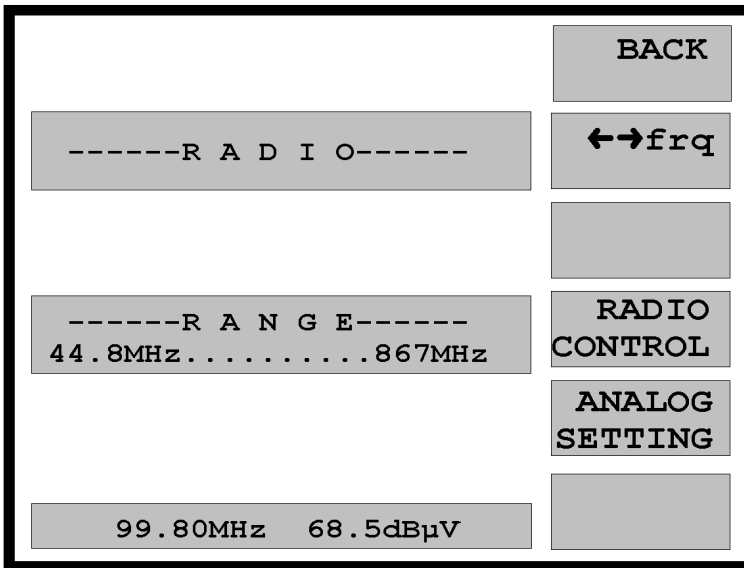

Returns to TV menu.

### Entering a frequency from 44.75 MHz to 867.20 MHz

The field lights up yellow as soon as the softkey is pressed. Now, the frequency can be entered in with the numerical buttons, „0...9,“ and the „MHz“ button or changed with the cursor buttons, ◀▶. The frequency is displayed on the screen in the lower left-hand corner.

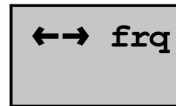

## RADIO CONTROL menu



In this menu, all remotely controlled parameters such as remote feed voltage, 22 kHz, DiSEqC, tone burst (Simple DiSEqC) and V-SEC can be set.

## ANALOG menu

In this menu, min./max. level measurements are possible and the „level beep“ can be activated.

## RADIO ANALOG menu

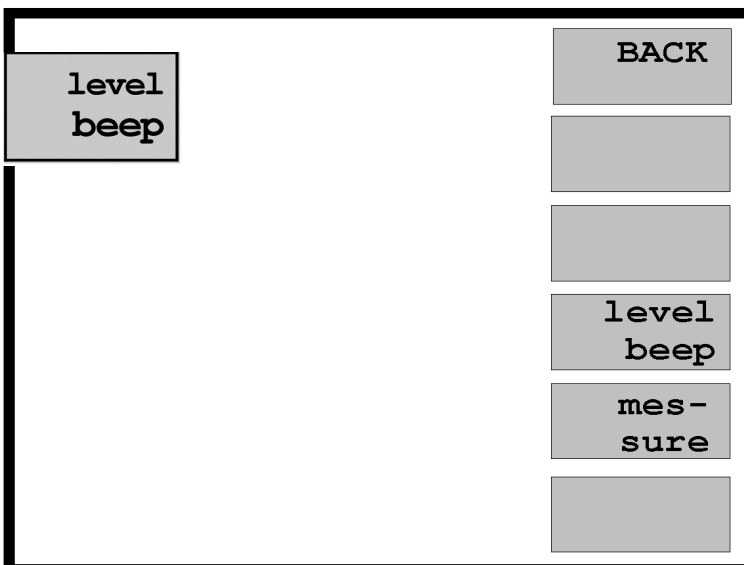

### Level-dependant acoustic signal

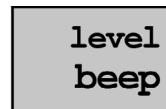

In the function, „level beep,“ a acoustic signal is generated, whose pitch is proportional to the received signal level.

With this signal, it is possible to optimally align the receiving antenna to a transmitter.

### Carrying out measurements

By pressing the button, the following value are measured:

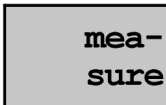

- Minimal and maximal level (min/max)

Level measurement

The reception frequency can be changed by using the cursor buttons, ◀▶.

# Radio Operation

## Measuring the min/max level

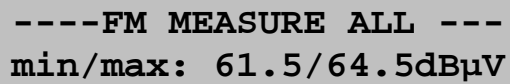

```
----FM MEASURE ALL ---  
min/max: 61.5/64.5dBµV
```

In the display, the following values are represented:  
*Minimal level: 61.5 dBµV*  
*Maximal level: 64.5 dBµV*

## Measuring the current level



```
██████████ 70  
frq 98.50MHz A 62.5dBµV
```

In the display, appears:  
*Frequency: 98.50 MHz*  
*Analogue reception : A*  
*Current level: 62.5 dBµV*

As long as this measurement function is called up, the MSK 33 measures the minimal level and the maximal level. This measurement function serves for monitoring the check points for level fluctuations.

# AV Menu

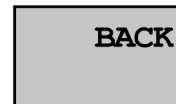
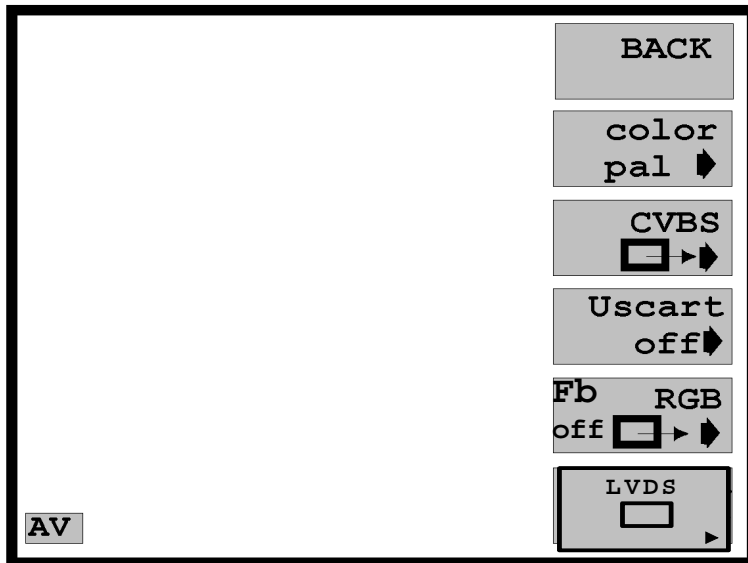

Calls up main menu

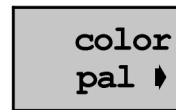

Selects the colour standards PAL, SECAM and NTSC



With the third softkey from the top, the following four operating types can be set on the Scart socket.

## Decoder operation

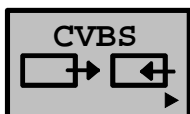

In this operating type, a decoder for decoding coded signals, e.g. Premiere, can be connected to the Scart socket.

## Decoder operation baseband

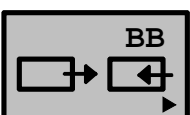

In this operating type, a decoder, which requires a baseband signal, can be connected to the Scart socket (This is only possible for satellite reception).

## Video input



After pressing this button, a video signal can be fed-in at the Scart socket and represented on the TFT screen.

## Video output

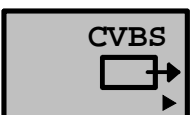

After pressing this button, the video signal is available on the Scart socket.

# AV Menu

## Breaking voltage



This function serves for supplying a breaking voltage on the Scart socket, in order to control external units. By pressing this button, the breaking voltage can be switched ON or OFF.

## RGB operation

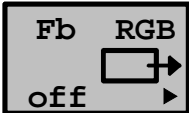

With this softkey, a RGB signal is available on the Scart socket or a RGB signal can be fed-in at the Scart socket. Also observe the function of the fast-blank-button.

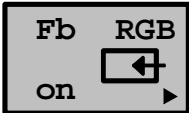

The fast-blank-signal can be switched on or off. If this function is switched on, the fast blank of the external unit can be fed-in and the external RGB signal becomes visible on the screen of the MSK 33.



**After exiting the AV menu, the last set AV operation type remains.**

**The video signal is displayed in the operation type RGB on an external monitor (television set) with the displayed softkey fields.**

## MPEG transport stream interface (TS-Parallel, LVDS) (optional)

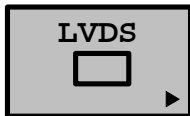

If the last softkey shows this representation, the input and output are locked.



According to this representation, the MPEG transport stream is on the interface TS-Parallel (rear panel of the unit).



In this function, a MPEG transport stream can be fed-in on the interface TS-Parallel (rear panel of the unit).



The MPEG decoder must be switched on in the TV or Sat digital menu (last softkey – MPEG PICTURE) for the input and output of a MPEG transport stream. Here, the current status is displayed in the second line of the on screen display.



## MPEG Decoder Menu (Optional)

|  |                 |
|--|-----------------|
| ---- PAT (08) --00--<br>>ZDF <                     | BACK            |
| 3sat<br>KiKa                                       | ▲               |
| Phoenix<br>ORF                                     | ▼               |
| Video-PID: 1040 MPEG 2V<br>Audio-PID: 1042 MPEG 2A | show<br>PAT     |
| Norm: dig. television<br>Status:running CA:no      | manual<br>V-PID |
|  | manual<br>A-PID |

After calling up this MPEG menu, you receive the PAT list for selecting the desired video or audio programme from the digital measurement for SAT, TV, IF or return path. Moreover, the PID numbers of the selected programme are displayed.

The data from the MPEG decoder appears in the last two lines.

Make sure, that the symbol rate and the code rate are correctly set in the digital menu. If this isn't the case, the message, „Frontend not locked,“ appears. Possibly control this in the constellation analysis. You receive the message „NO PAT,“ when no programme list is found.

```
---- PAT (08) --00--
>ZDF <
```

The programme access table shows the available video and audio channels on the MPEG transport stream. Eight programmes are available; five of them are displayed. The programme, 00, is decoded and the picture is shown.

With the arrow softkeys, the desired programme can be selected.

```
Video-PID:1040 MPEG 2V
Audio-PID:1042 MPEG 2A
```

Here, the video and audio programme identify codes of the selected programme are displayed. By pressing the buttons „manual V-PID“ and „manual A-PID,“ the PIDs can be entered in by hand with four digits.

The button „show PAT“ starts the repeated search for the programme list.

Status display of the MPEG decoder:

```
Norm: dig. television
Status:running CA:no
```

Norm: dig. television, dig. audio, data broadcast or reserved  
 Status: running, not run, wait sec, pausing, undefined or reserved  
 CA: conditional access yes /no  
 Scrambled yes / no

# Setting Menu

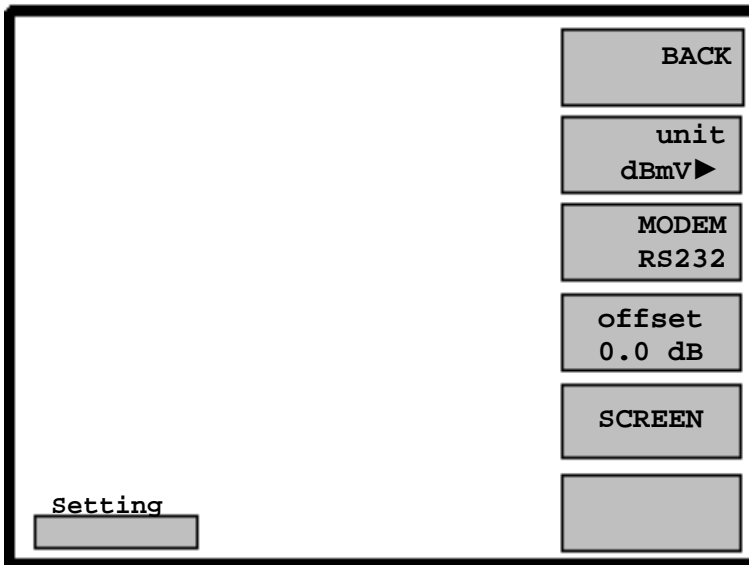

Calls up main menu

## Modem menu

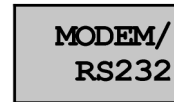

In this menu, all settings for the remote control of the MSK 33 can be carried out via the interface RS232 (refer to respective section).

## Screen menu

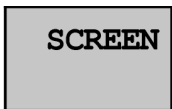

In this menu, brightness, contrast, colour and background light of this TFT screen are set.

## SYSTEM menu

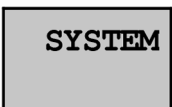

In this menu, date and time as well as the software version and the unit number are given out.

## Measuring unit

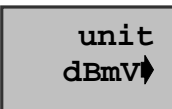

Softkey for the switch-over of dB $\mu$ V to dBmV and vice versa.

## Entering the level offset

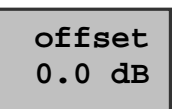

With this softkey, you can enter in a level offset up to !9.5 dB in 0.5 dB increments. An entered offset is to be recognised by the exclamation point behind the level display.

# Screen Menu

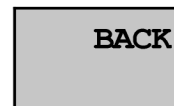
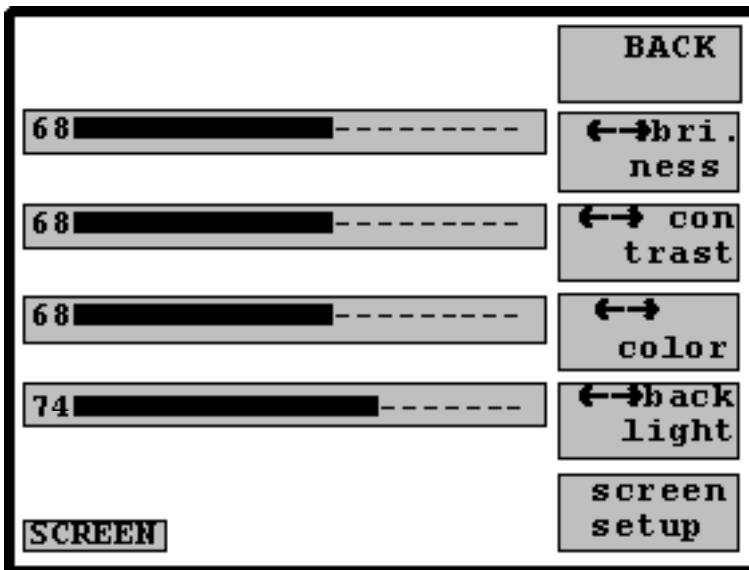

Returns to SETTING menu

## Setting the brightness

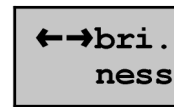

By pressing this button, the brightness of the screen can be set with the cursor buttons, ◀▶. The set value is auto-

matically saved.

## Setting the contrast

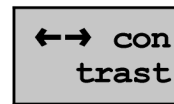

Pressing this button allows the contrast setting can with the cursor buttons, ◀▶. The set value is automatically saved.

## Setting the colour saturation

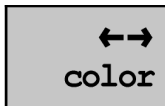

Pressing this button allows the colour saturation to be set with the cursor buttons, ◀▶. The set value is automatically saved.

## Setting the background light

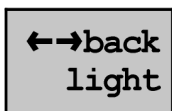

Pressing this button allows the background light to be set with the cursor buttons, ◀▶. The set value is automatically saved.

## Factory setting

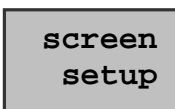

By pressing this button, all display settings can be reset to the factory settings.

# System Menu

|   |                |
|---|----------------|
| -SOFTWARE-VERSIONS-<br>BE --- -- -- --  | BACK           |
| S0 operating system<br>S1 FPGA firmware | time           |
| S0 = V8.1 S1 =V2.1                      | date           |
|   | click<br>off   |
|   | fact.<br>setup |
| SN : 00612                              | serv           |
| TIME: 14:31:26<br>DATE: 14.11.01        |                |

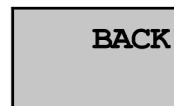

**Calls up the SYSTEM menu**

The screen displays the following in the individual fields:  
Software versions of the modules (S0 shows information about the operating software, S7 shows the software of the graphic card). These are followed by the series number (SN: -----) as well as the time and date.

### Setting the date



Press the softkey. The field „DATE“ lights up yellow and the date field flashes. The date can now be entered in with the numerical buttons.

### Setting the time

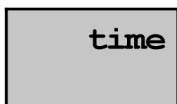

After pressing this softkey, the field „TIME“ lights up yellow and the time field flashes. The time can now be entered in with the numerical buttons.

### Click button

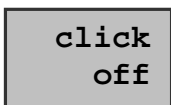

With this button, a beep tone for the keyboard can be generated and switched off.

### Factory setting

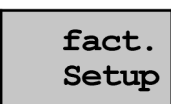

By pressing this button, all display settings can be reset to the factory settings.



No user function. It is only required for service purposes.

### Note:



**From the software version S0=V7.0 and higher, the graphic software S1=2.1 must be downloaded.**

**S1=V2.1 is not downwards compatible. It can not longer carry out a panoramic printout.**

# Copy Menu

|                       |             |          |                 |
|-----------------------|-------------|----------|-----------------|
| 0                     | T A         | 210.25M  |                 |
| 1                     | TsA         | 335.25M  | recall<br>nr.-- |
| 2                     | TsA         | 303.25M  |                 |
| 3                     | TsA         | 280.25M  | store<br>nr.--  |
| 4                     | TsD         | 362.00M  |                 |
| 5                     | S A         | 1597.00M | print<br>data   |
| 6                     | S D         | 1990.00M |                 |
| 7                     | NO SETTINGS |          | line<br>feed    |
| 8                     | NO SETTINGS |          |                 |
| !BACK with COPY key ! |             |          | PANO.<br>PRINT  |

The copy menu is called up with the copy button. Exit the menu by pressing the button once more.

## Saving and calling up unit settings

### Saving the unit settings

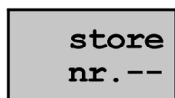

One hundred memory positions (00-99) are available for saving the settings of the unit. First, select the unit setting, which is to be saved, and then call up the COPY menu. By pressing the softkey „store nr. --“ and entering a second digit by means of the numerical buttons, the last set unit setting is saved under the selected memory position.

The saved settings are displayed on the screen in abbreviated form:

| No. | Operating type | Frequency (MHz) | Meaning                     |
|-----|----------------|-----------------|-----------------------------|
| 0   | T A            | 210.25M         | TV analogue                 |
| 1   | T s A          | 319.25M         | TV Special channel analogue |
| 2   | T D            | 213.00M         | TV digital                  |
| 3   | T s D          | 338.00M         | TV Special channel digital  |
| 4   | S A            | 1597.00M        | SAT analogue                |
| 5   | S D            | 1990.00M        | SAT digital                 |
| 6   | R A            | 98.00M          | Radio analogue              |

You can scroll down the setting list by using the cursor buttons, ▲▼.

### Calling up saved settings

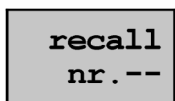

Saved settings can be called up by entering the memory position. By pressing on this button, the field „recall nr.--“ lights up yellow. Now, the position of the desired memory position can be typed with the numerical buttons. If the called up memory position is not found, the message „NO SETTINGS FOUND“ appears on the screen.



The saved settings are not deleted during a software update, but can be written over by new settings. The memory positions 80...95 are occupied at the factory with the most important DiSEqC commands.

### Calls up the panoramic printout menu

This softkey no longer applies to the software versions 7.0 and higher. The panoramic printout can only be carried out via the spectrum analysis with the command „COPY“ and „print data.“

# Copy Menu

print  
data

Printing the measurement results

By pressing the softkey, the current measurement result along with the date and time are printed out.

```
21.06.98 15:32
C10 210.25MHz A 56.0dBµV
```

Printing out a measurement result in TV mode with:

- Date and time
- Channel number, frequency
- Analogue measurement (A), level.

If the function, „measure,“ is called up in the TV, Sat or FM menu, all the measurements are printed out.

## Printing out all measurements in TV mode

```
21.06.98 15:32
---- TV MEASURE ALL ----
SC1/SC2:-13.0 /--.- dB
NICAM : -20.0dB
BER : 8.20E-06
min/max: 52.5/ 59.0 dBµV
C10 210.25MHz A 56.0dBµV
```

The printout contains the following measurement results:

- Date and time
- Audio carrier spacing TT1: - 13 dB
- Audio carrier spacing TT2: not available
- Audio carrier spacing NICAM: - 20 dB
- Bit error rate NICAM: 8.20E -06
- Minimal level: 52.5 dBµV
- Maximal level: 59 dBµV
- Channel: 10
- Video carrier frequency: 210.25 MHz
- Analogue measurement: A
- Current level: 56 dBµV

## Printing out all measurements in Sat mode

```
21.06.98 15:32
--- SAT MEASURE ALL ---
min/max: 67.5/ 69.0 dBµV
→←11373.15MHz A68.0dBµV
```

The printout contains the following measurement results:

- Minimal level: 67.5 dBµV
- Maximal level: 69 dBµV
- Transponder frequency: 11373,15 MHz
- Analogue measurement: A
- Current level: 68 dBµV

line  
feed

Line feed

# Mode Menu

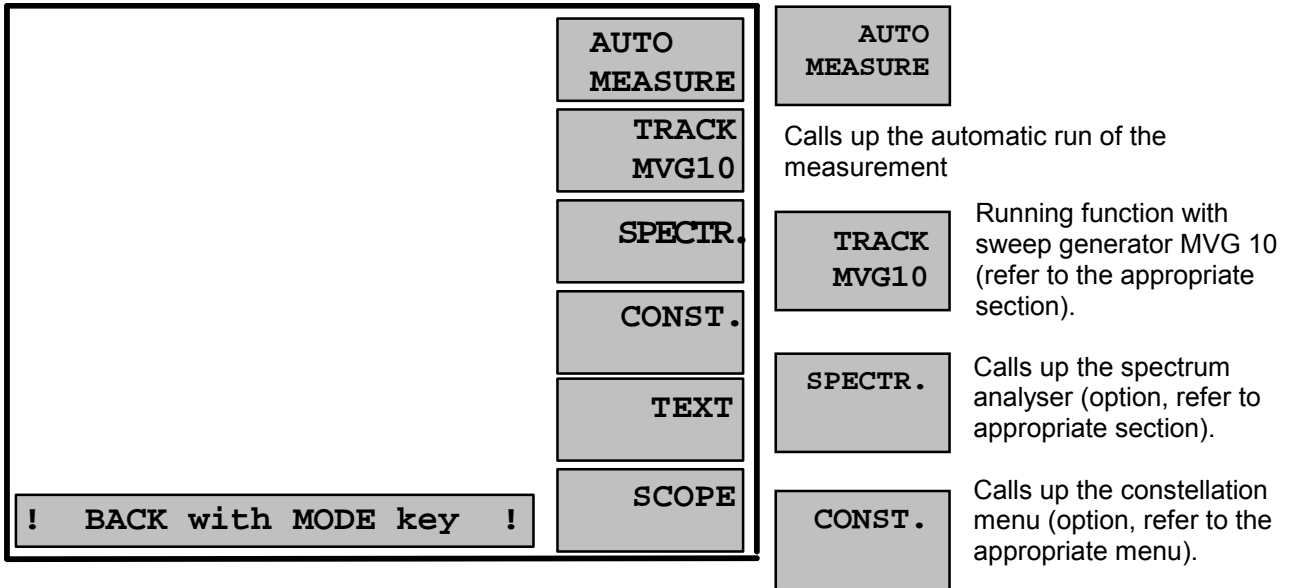

TEXT

Calls up the TEXT menu (refer to the appropriate section).

SCOPE

Calls up the SCOPE menu (option, refer to the appropriate section).

Exit the mode menu by pressing the button „**MODE**“ once more.

# Text Menu

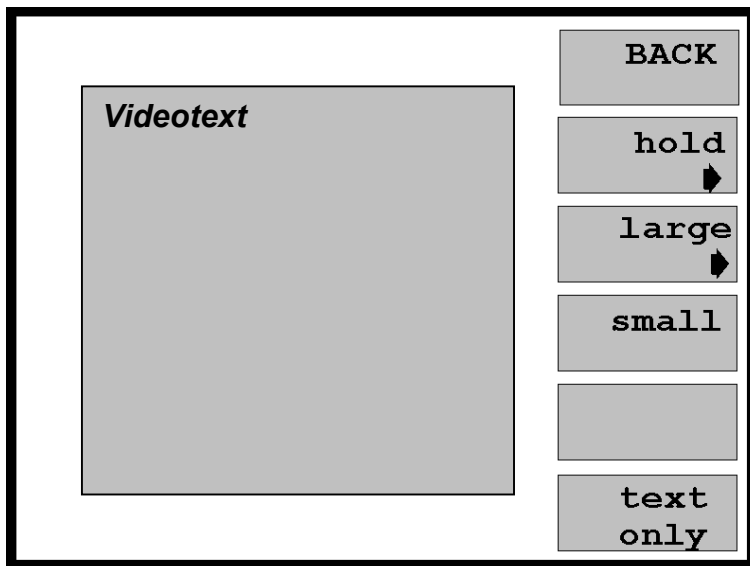

The videotext page number can be entered in with the numerical buttons. The page number is displayed in the upper left-hand corner.

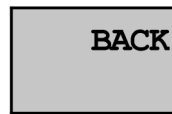

Returns to the main menu.

## Holding the videotext page

By pressing this button, the current videotext page freezes. The field is now highlighted in yellow. By pressing the button again, the videotext page is released.

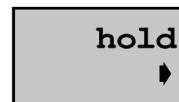

## Enlarging the videotext page

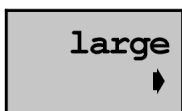

By pressing the button, the upper or lower area of the text page can be enlarged.

## Original videotext size

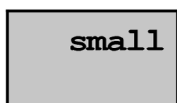

By pressing this button, the function LARGE is deactivated. The page appears in the original size.

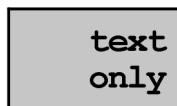

By pressing this button or the „OSD/Help“ button, the softkey lettering is deleted. The videotext numbers can be continued to be entered in via the keyboard. Press this button or the „OSD/Help“ button once more, and the softkey lettering is switched on again.



# Scope Menu

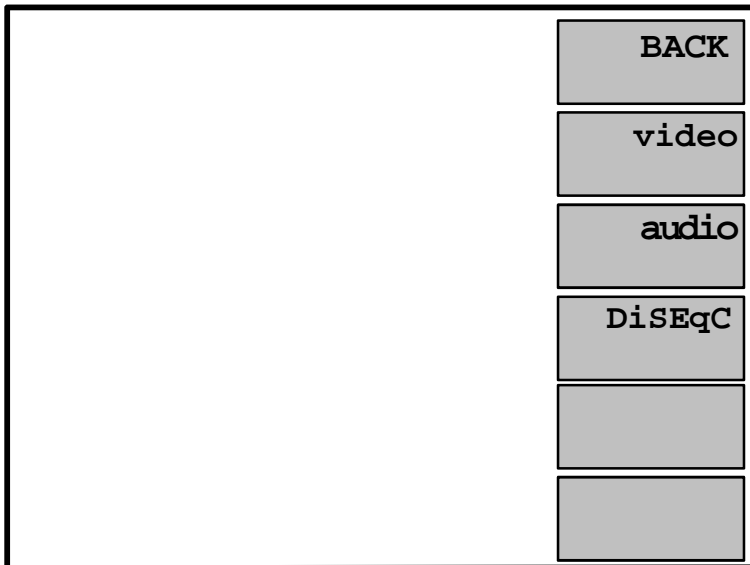

The last set menu is called up.

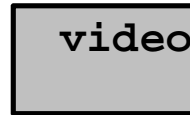

With this button, you can switch on the video scope.

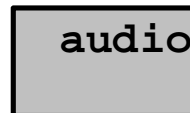

Switches on the audio scope menu.



Switches on the DiSEqC scope.

## Video scope menu

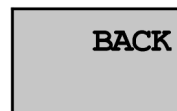
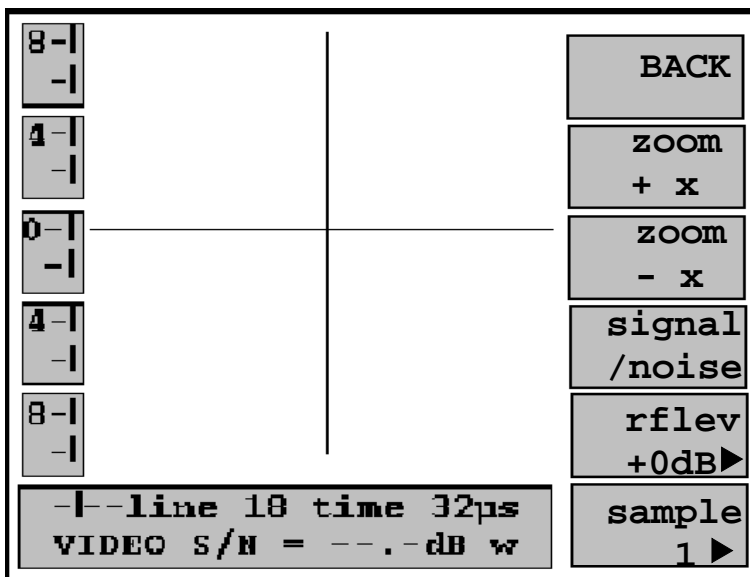

The last set menu is called up.

### Horizontal zoom –Enlarging the video signal



By pressing this button, the video signal can be zoomed on the screen. Eight zoom stages are available. Each time the button is pressed, the zoom switches to the next stage. If the field no longer lights up yellow, the highest zoom stage is reached.

### Horizontal zoom – Reducing the video signal

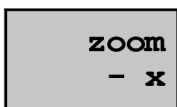

By pressing this button, the video signal can be reduced on the screen. Eight zoom stages are available. Each time the button is pressed, the zoom switches to the next lower stage. If the field no longer lights up yellow, the lowest zoom stage is reached.

### S/N measurement

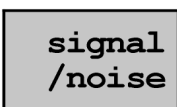

The S/N measurement is carried out, in order to measure the signal-to-noise spacing of TV and Sat signals. The S/N measurement is carried out weighted with CCIR filters. The measurement of the noise level is carried out in an empty line; the line must be manually set. With the „zoom x“ button, the video signal is set in such a way, that no synchronised impulse or picture content are shown on the TFT screen. By pressing the softkey, the S/M measurement begins. The measured S/N value appears afterwards on the screen.

# Scope Menu

The following values are displayed on the screen:

```
|- line 6 time 38µs  
VIDEO S/N = 37,5dB w
```

*Line 6*  
*Time 38 µs – based on the line and is measured in the centre of the screen.*  
*Signal/noise spacing S/N = 37.5 dB w (weighted)*

```
rflev  
+0dB ▶
```

With this softkey, the input loss can be changed to +4 dB and +8 dB. This increases the measurement dynamic. (**Be careful of intermodulation!**).

```
sample  
1 ▶
```

Number of the measuring cycles with averaging (1 to 5 measuring cycles).

## Measurement of the amplitude of the video signal

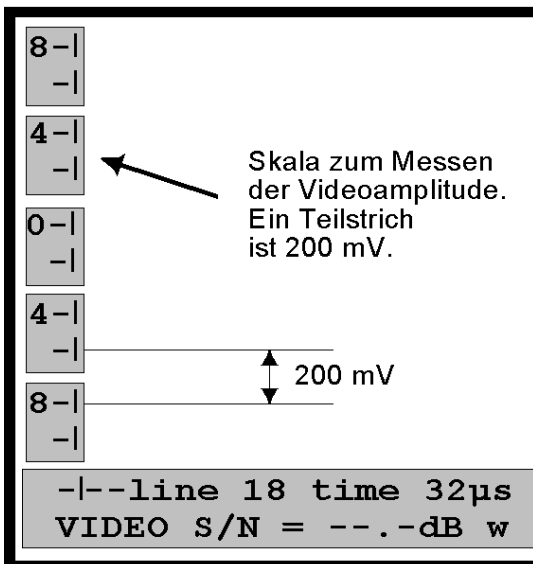

The video level of the fed-in RF signal can also be measured in the SCOPE menu.

On the scale on the left margin of the screen, the video level can be read. The scale is divided in 200 mV steps (a secondary graduation line). The position of the video signal can be changed with the cursor buttons.

### Selecting the video line

The video line can be selected with the numerical buttons, 0..9. After entering in a three-digit number, it is automatically taken over. After entering a one-digit or 2-digit number, the entry is adopted once you press the Enter button. Scroll down the video lines with the cursor buttons, ◀ and ▶. Here, it is recommended to switch off the zoom function or set to the minimal zoom.

## Measurement of video signals via the AV socket (SCART)

Via the AV socket (Scart), a video signal can be fed-in and represented on the oscilloscope.

To do so, the function CVBS input must be selected in the AV menu. The maximal input voltage is 2 V<sub>pp</sub>. The scale is divided in 0.2 V/units.

# Audio Scope

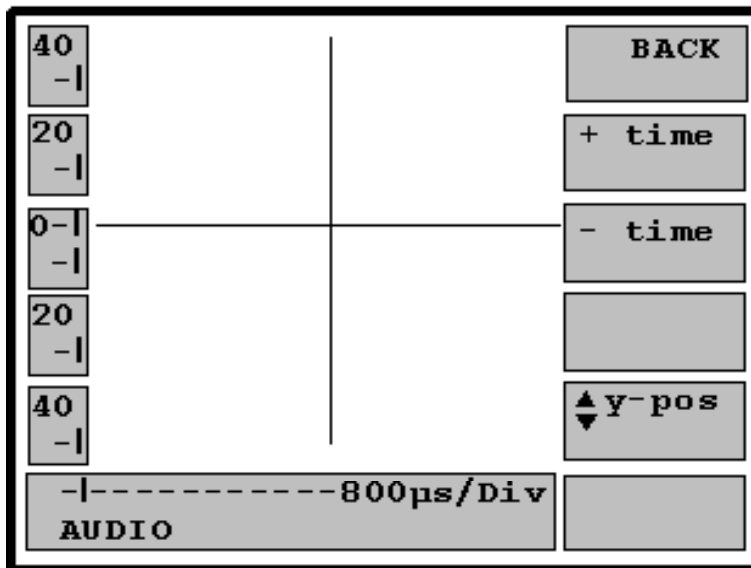

The last set menu is called up.

## Increasing time / unit

With this function, the audio signal can be compressed on the display. Eight time-stages are available. The unit switches to the next highest time stage once the button is pressed. If the softkey field no longer changes colour, the highest time stage is reached.

## Reducing time / unit

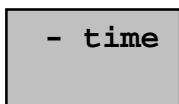

With this function, the audio signal can be lengthened on the display. Eight time-stages are available. The unit switches accordingly to the next lower time stage, when the button is pressed once more. If the softkey field no longer changes colour, the lowest time stage is reached.

## Position of the audio signal

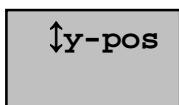

With the cursor buttons, the vertical position of audio signal can be changed. The trigger point, which lies at 0 V, is set or changed with this button.

## Measuring the FM hub

The FM hub of the received audio carrier can be measured in the SCOPE menu. The scale on the left margin of the screen serves to measure the audio FM hub. It is divided in 10 kHz increments (a secondary graduation line) for TV and radio reception and in 20 kHz increments for SAT reception. The condition of the audio signal can be changed by using the cursor buttons.

## Measuring an audio signal via the AV socket (SCART)

An audio signal can be fed-in via the AV socket (SCART) and represented on the oscilloscope.

For this purpose, the function CVBS input is to be selected in the AV menu. The maximal input voltage is 2 V<sub>pp</sub>. The scale is divided into 0.25 unit.

# DiSEqC Scope

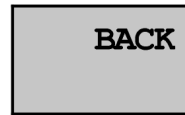
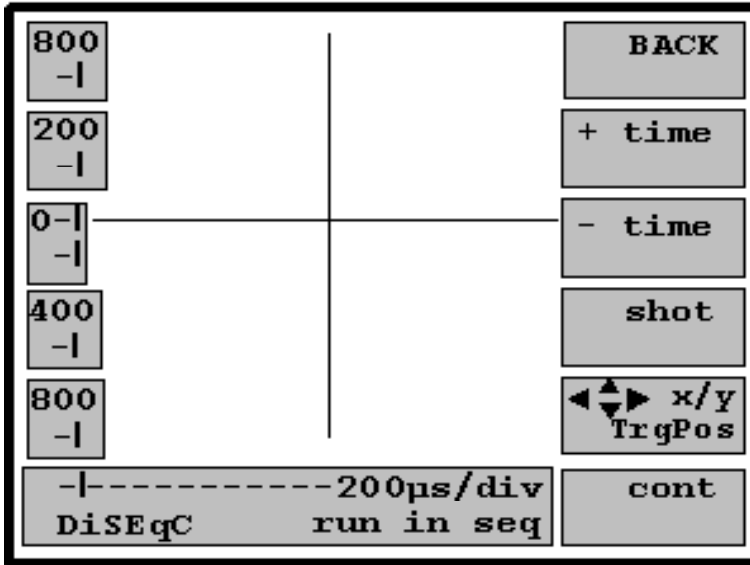

Calls up the last set menu.

## Increasing time / unit

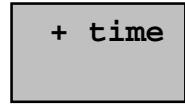

With this function, the DiSEqC signal can be compressed on the display. Eight control time-stages are available. The unit switched accordingly to the next highest stage, when the button is pressed once more. If the softkey field no longer changes colour, the highest stage is reached.

## Reducing time / unit

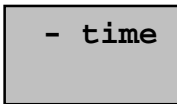

With this function, the DiSEqC signal can be stretched on the display. Eight control time-stages are available. The unit switches accordingly to the next lowest stage, once the button is pressed once more. If the softkey field no longer changes colour, the lowest stage is reached.

## Saving function

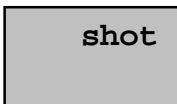

By pressing this button, the saving oscilloscope is set to standby. As soon as a DiSEqC signal is on the antenna socket of the MSK 33, it is recorded and saved until you either press the button again or switch over with the button „cont“ to continuous recording.



Switches the oscilloscope back to continuous recording.

## Position and triggering of the DiSEqC signal

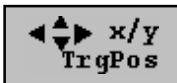

With the cursor buttons, ▼▲, the vertical position of the DiSEqC signal can be changed. The trigger point, which at 14 or 18V, is then also set or changed.

With the horizontal cursor buttons, ◀▶, the type of representation of the DiSEqC can be selected:

- run in seq = Swing in sequence
- run out seq = Swing out sequence
- carrier = 22 kHz carrier
- modulation = carrier modulation

# Spectral Menu

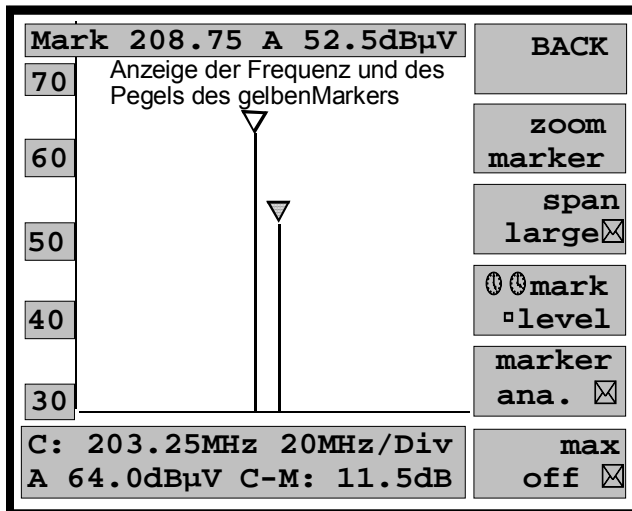

The function spectrum can be called up in the operating modes, SAT, TV, RADIO and RETURN-PATH. The operation of this function is principally identical in all various operating modes; Differences are explained in the following text.

The set spectrum is scanned approximately every three seconds and updated on the display. A marker, which is indicated by a yellow triangle, is available for the level measurements on analogue and digital signals. Level comparison measurement can be carried out by means of the delta marker function.

the mid-frequency is always displayed by the last set channel in TV operation or the last set frequency in Sat operation.

The display shows the following values:

- Frequency of yellow marker: 208.75 MHz
- Level of yellow marker: 52.5 dBµV
- Carrier frequency 203.25 MHz
- Definition per scale unit 20 MHz
- Analogue measurement (A)
- Level of white marker: 64.0 dBµV
- Delta level: (C-M): 11.5dB

## Level measurement of analogue signals

By calling up the spectrum analysis from the analogue TV or Sat menu, the analogue level on the white marker is measured and displayed on the screen in the lower line. The analogue measured value is identified with „A“ located in front.

## Level measurement of digital signals

By calling up the spectrum analysis from the digital TV or Sat menu, the digital level on the white marker is measured and displayed on the screen in the lower line. The digital measured value is indicated with a „D“ located in front.

*For the establishment of digital levels, the MSK 33 calculates a correction value, which is represented by a thin line under the white marker. This value is influenced by the respective set spectrum measurement bandwidth (see below) and symbol rate.*

*Therefore, observe the correct setting of the symbol rate in the TV and Sat menu!*

*For DVB-T, the appropriate channel bandwidth (6, 7 or 8 MHz) is set in the TV menu.*

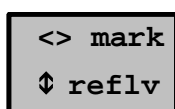

With the cursor buttons ◀▶, the position of the yellow marker can be determined. Frequency and level of the yellow marker is displayed.

By pressing the cursor buttons, ▲▼, the reference level can be changed in 4 dB increments ( The spectrum is moved up or down).

# Spectral Menu

## Selecting the spectrum representation

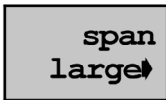

By pressing this button, the represented frequency range can be defined per scale unit. The following settings are possible:

| Setting | SAT operation |       | TV operation |         | Return path operation |       | RADIO operation                              |
|---------|---------------|-------|--------------|---------|-----------------------|-------|--|
|         | Span/DIV      | BW    | Span/DIV     | BW      | Span/DIV              | BW    |  |
| large   | 100 MHz       | 8 MHz | 20 MHz       | 1 MHz   | -----                 | ----- | 2 MHz<br>No selection possible<br>BW 200 KHz |
| med.    | 20 MHz        | 1 MHz | 5 MHz        | 1 MHz   | 5 MHz                 | 1 MHz |  |
| small   | 5 MHz         | 1 MHz | 1 MHz        | 200 KHz | 1 MHz                 | 200 K |  |
| full    | -----         | ----- | 100 MHz      | 8 MHz   | -----                 | ----- |  |

## ANALOG marker

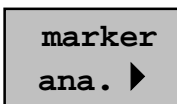

The marker can be used for level measurements of analogue carriers in represented spectrum on the screen; here, the marker is placed on the carrier. A yellow triangle in the screen shows the position of the marker. With the cursor buttons, ◀▶, the position of the marker can be determined. The frequency and level display of the marker appears on the upper margin on the screen. The level difference (C-M) to the white marker (carrier) is displayed on the lower margin of the screen.

## DIGITAL marker

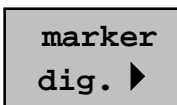

Press the same softkey. The upper display changes from A to D (digital measurement). With the cursor buttons ◀▶, the position of the marker can be set. The frequency and level display of the marker appear on the upper margin of the screen. The level difference (C-M) to the white marker (carrier) is displayed in the lower margin of the screen.



*For the establishment of digital levels, the MSK 33 calculates a correction value, which is represented by a thin line under the yellow marker. This value is influenced by the respective set spectrum measurement bandwidth (see below) and the symbol rate.*

*Therefore, observe the correct setting of the symbol rate in the TV and Sat menu!*

*For DVB-T, the appropriate channel bandwidth (6, 7 or 8 MHz) is set in the TV menu.*



The scale on the left margin of the screen serves for orientation in the digital operation. The level of a digital carrier can only be determined with the white or yellow marker!

## C/N measurement of analogue signals in Sat operation

The spectrum menu is opened in the setting, analogue reception. The yellow marker is shifted between the two carriers or in a frequency gap. The C/N measurement is carried out in medium or small span.



The softkey (yellow marker) must display the setting „dig.“

For noise bandwidth matching, the symbol rate (for DVB-T chBW) set in the SAT or TV menu is used. It must have been set for the C/N measurement in the SAT range to 27.5 MS and in the TV range to 6.9 MS (at DVB-T to 7 or 8 MHz).

Carry out the C/N measurement for the satellite reception directly behind the LNB. For systems with cable slope, the measurement result can be incorrect, if the C/N measurement occurs for subscriber connection.

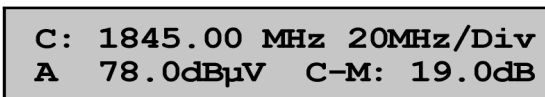

The C/N value is displayed now in the right-hand corner (C-M) on the TFT display.

# Spectral Menu

## C/N measurement of digital signals in Sat operation

marker  
dig. ▶

The spectrum menu is opened in the setting, digital reception. The yellow marker is moved between two carriers or in frequency gaps. The C/N measurement is carried out in medium or small span.

The softkey (yellow marker) must display the setting „dig.“

For noise bandwidth matching, the symbol rate set in the SAT or TV menu (for DVB-T the chBW) is used. It must have been set for the C/N measurement in the SAT range to 27.5 MS and in the TV range to 6.9 MS (at DVB-T to 7 or 8 MHz).

Carry out the C/N measurement for the satellite reception directly behind the LNB. For systems with cable slope, the measurement result can be incorrect, if the C/N measurement occurs for subscriber connection.

For analogue or digital C/N measurements, the symbol rate in the SAT MEASURE menu must be set to 27.5 MS. The noise measurement bandwidth is based on 27.5 MHz.

## Cross-polarisation measurement on signals in SAT operation

Possibly, a transponder of the other polarisation planes is recognised as a small knob between the two transponders for a poor aligned LNB. Place the yellow marker on this knob. The display C-M represents the cross-polarisation spacing. Measure in digital reception mode for digital carriers and in analogue reception mode for analogue carriers. The marker is also to be set to analogue or digital according to the reception mode.

zoom  
marker

This function allows an enlargement of the spectrum on the yellow marker position. If you press this button, the frequency of the yellow marker is transmitted to the white carrier marker and zoomed to „small span.“ After exiting the spectrum analysis, the frequency is also adopted in the picture representation.

max  
off ▶

By pressing this button, the spectrum is switched to „Max hold.“ Pressing the button again switches it back to clear write.



If you have an unit with a graphic card (MSK33G, MSK33Q, MSK33M), you can also printout the spectrum of the spectrum analysis. To do so, press the button „COPY“ in the spectrum analysis and then the softkey button, „print data“. After the printout, return to the original measuring job by pressing the button „COPY“ once more.

# Const Menu

The function constellation diagram can be called up in the operation types, SAT (DVB-S), TV (DVB-C and DVB-T), TV-IF or return path (DVB-C). Operating the constellation functions is principally the same in the various operating types. The differences are described below.

## Colour representation of I/Q value pairs

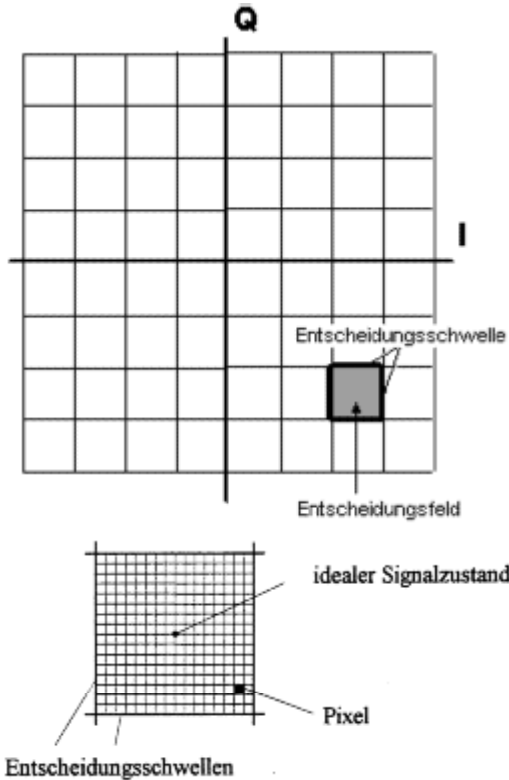

The colour representation of the I/Q value pairs should simplify the analysis of the constellation diagram in regards to the occurring error. The colour of the I/Q value pairs changes with the number of hits on one point within the decision field. In an ideal case, the I/Q value pairs are always in the middle of the decision field. However the I/Q value pairs are influenced by interference on the transmission paths or in the modulator on the transmitting side. As long as the I/Q value pairs lie within the decision waves, a clear relation of valence in the receiver can occur. The decision field is subdivided into signal subsurfaces, also called pixels. For a black/white representation, one could not represent the frequency of the hits of a I/Q value pair on the surface of a pixel. The colour representation of the MSK 33 allows the frequency of the hits of a I/Q value pair on the surface of a pixel to be described by the changing of colour. If many I/Q value pairs meet on a pixel, RED is represented, however if very few I/Q value pairs meet on a pixel, blue is represented. Four colours are available for the assessment of the „scores.“

- RED – very many hits
- YELLOW – many hits
- GREEN – few hits
- BLUE – very few hits

## Constellation diagram for QPSK (DVB-S)

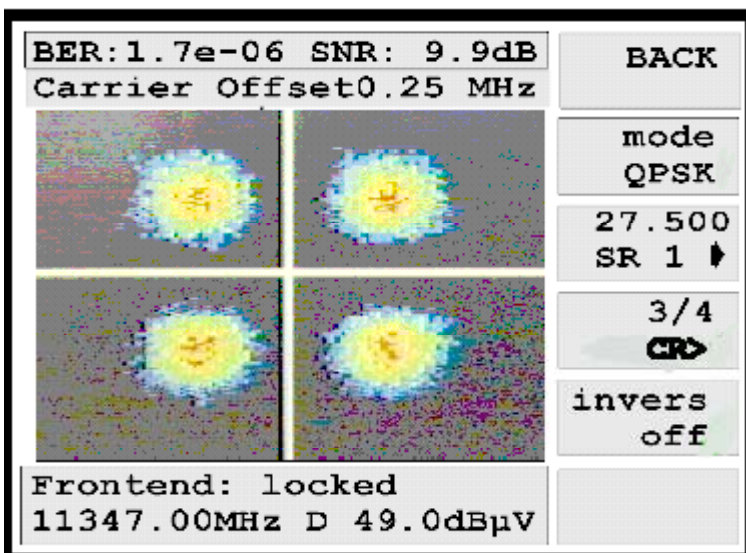

For the digital transmission via satellite, the modulation type QPSK (Quadrature Phase Shift Keying) is used. Every 2 information bits are put together to one symbol and modulate one carrier in its phase. With this, four conditions are possible, which a receiver must recognise.

A crosshair with four clouds, which represent the possible symbols or their frequency in the quadrants appear on the colour screen.

## Measurement of the bit error rate (BER)

Since it deals with transmission of binary data for DVB-S, the bit error rate can be considered as measurement for the occurred transmission error in the data stream. In the MSK 33, a BER measurement is carried out before the viterbi decoder and displayed on the screen. The bit error rate is the ratio of the number of received detected bits divided by the entire number of the received bits. The lowest bit error



# Const Menu

rate, which the MSK 33 can measure, is  $1.0 \times 10^{-8}$ . If the rate is lower than these values, the display of the BER jumps to zero „0“ (no longer bit error). The highest BER, which can be displayed, is  $1 \times 10^{-2}$ . Generally, it can be assumed, that picture disturbance can occur by a BER of ca.  $1 \times 10^{-3}$ .

## Measurement of signal noise ratio (SNR)

The conception of the MSK 33 allows the S/N ratio of the I- and Q- data stream to be displayed in addition to the C/N measurement on the digital carriers in the Const-menu. The measurement is carried out after the QPSK demodulation and can be called in as an indicator for the noise on the I/Q signals. Differences in the result to the C/N measurement in the spectrum menu can be caused by the complex interfering influences of the digital signal or by differences in the input level. The SNR value is displayed on the upper edge of the TFT screen.

The best value, which the MSK 33 can measure, is 12 dB. If the value is better than 12 dB, this is indicated with a arrow in front of the measured value.

## Carrier offset

The carrier offset display represents the difference between the set receiving frequency on the MSK 33 and the transmitting frequency of the digital signal in MHz. The carrier offset is displayed on the upper edge of the TFT screen.

With the cursor buttons, ◀▶, the receiving frequency of the MSK 33 can be changed and the frequency offset can be set to zero. The carrier offset displays, which frequency position the LO of the used LNB has.

## Frontend locked

|   |                  |
|---|------------------|
| BER: 1.7e-06 SNR: 9.5dB   | BACK             |
| Carrier Offset 0.3 MHz  |                  |
| Anzeige der Bit-Fehler-Rate, des Signal-Rausch-Abstandes und der Trägerablage | mode<br>QPSK >   |
|   | 27.500<br>SR 1 ▾ |
|   | 3/4<br>CR ▾      |
| Anzeige von Träger-Frequenz und Pegel (digital)                               | invers<br>no     |
| Frontend: locked  |                  |
| 11347.00MHz D 49.0dBµV  |                  |

**BACK** If the receiving unit of the MSK 33 is locked on the carrier frequency of the received signal, the display „frontend locked“ appears on the screen. „Not locked“, appears in the display, if a representation of the constellation diagram is not possible. An analysis of the constellation diagram or an assessment of the measurement results can first occur, as soon as the receiving signal is locked. The symbol rate and the code rate are to be set here to the required values. The inversion of the spectrum (inverse /no) is automatically set.

The display shows the following values:

- BER = Bit error rate:  $1.7 \times 10^{-6}$
- SNR = Signal noise ratio: 9.5 dB
- Carrier-Offset: -0,3 MHz
- Frontend locked
- Carrier frequency: 11347.00 MHz
- Digital measurement (D)
- Carrier level: 49.0 dBµV

The last set menu is called up.

## Const Menu

27.500  
SR 1 ▶

### Selecting the symbol rate (symbol-clock)

27.5 MS, 20 MS, 24.5 MS or 22 MS – or entry between 0.5...32 MS.

3/4  
CR ▶

### Selecting the code rate

(1/2, 2/3, 3/4, 4/5, 5/6, 6/7, 7/8, 8/9)

Invers  
(no)

### Inverting /not inverting a constellation diagram

Display the status of the frequency spectrums or the constellation diagram. Setting automatically occurs.

Mode  
QPSK

No function.

# Const Menu

## Examples for QPSK constellation diagrams

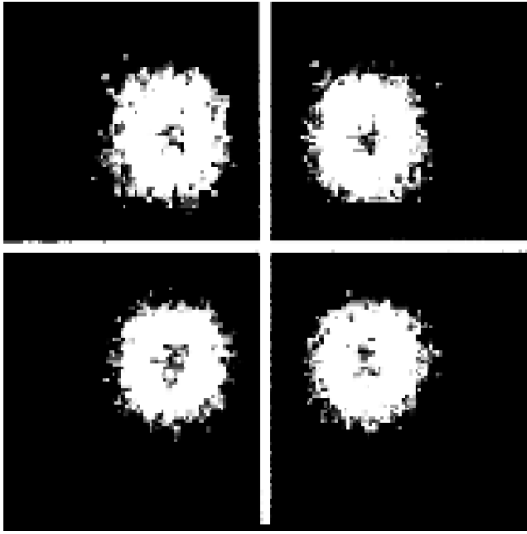

QPSK signal without faults

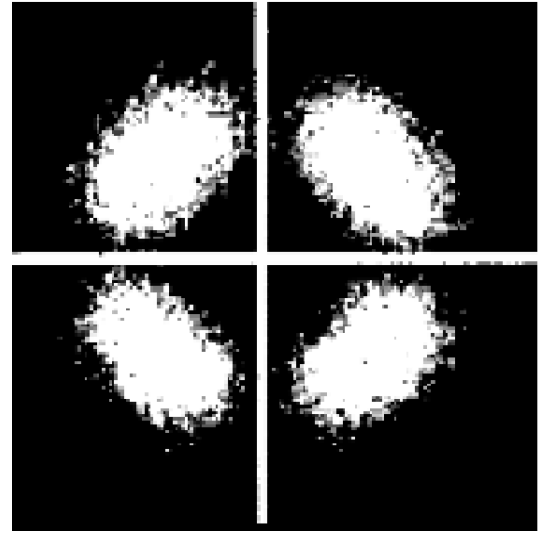

QPSK signal with phase noise (LNC)

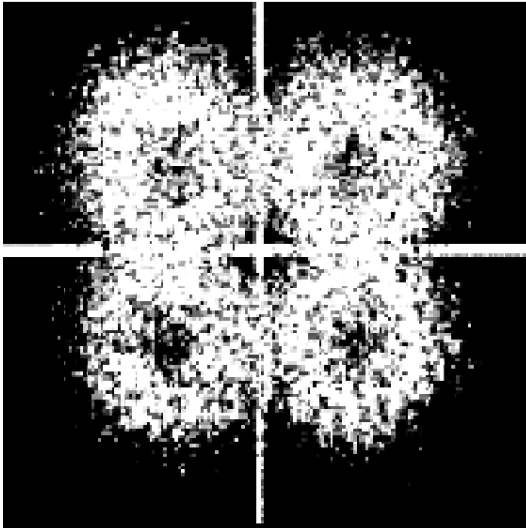

QPSK signal with intermodulation noise

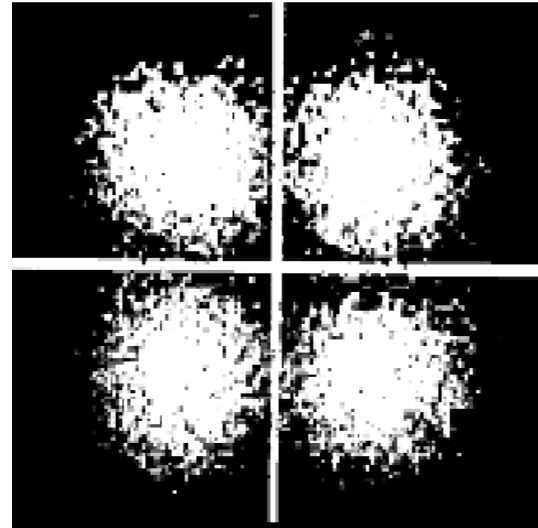

QPSK signal with superposed broadband noise. Possible cause: Defective amplifier or high cable loss.

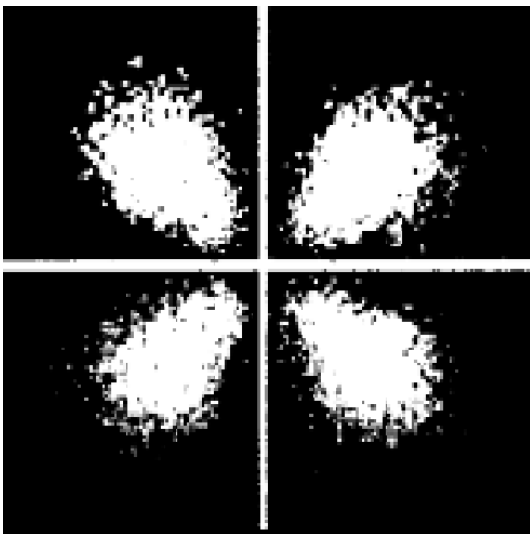

QPSK signal with amplitude hum of an amplifier

# Const Menu

## Constellation diagram for QAM (DVB-C)

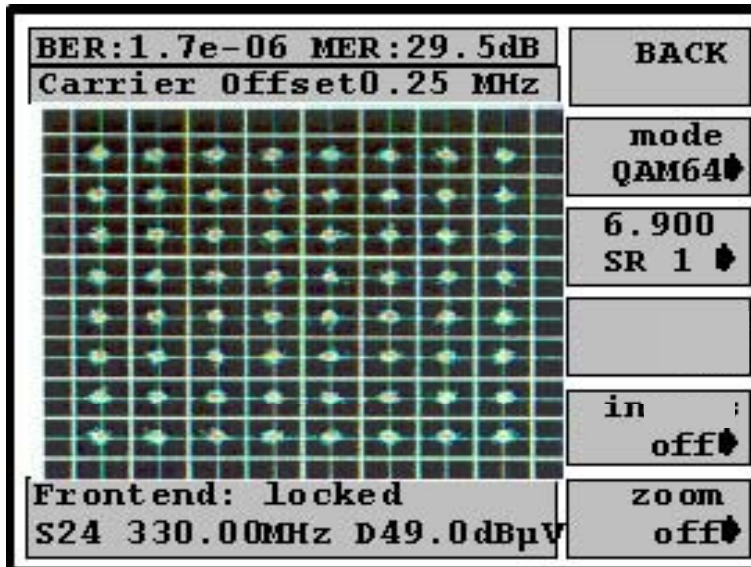

For digital transmission via cables, the modulation type QAM (Quadrature Amplitude Modulation) is used. The MSK 33 can represent the constellation of the modulation types, QAM64 and QAM128. For QAM 64, every 6 information bits are put together to one symbol and modulate one carrier in its amplitude and phase. With this, 64 conditions are possible, which a receiver must recognise for correct assessment of a QAM signal.

A „chessboard“ with 64 or 128 clouds, which represent the possible symbols or their frequency in the fields, appears on the colour screen.

You can select the menu items by pressing the buttons on the right of the screen. Submenus are immediately called up by

pressing the appropriate softkey. The buttons are represented in yellow for activated functions. Buttons, which have multi-functions, are indicated with an arrow and are represented in yellow as well. By repeatedly pressing the same button, different parameters can be called up and displayed.

## Measurement of the bit error rate (BER)

Since it deals with transmission of binary data for DVB-C, the bit error rate can be considered as measurement for the occurring transmission error in the data stream. In the MSK 33, a BER measurement is carried out before the error correction and displayed on the screen. The bit error rate is the ratio of the number of received defective bits divided by the entire number of the received bits. The lowest bit error rate, which the MSK 33 can measure, is  $1.0 \times 10^{-8}$ . If the rate is lower than this value, the display of the BER jumps to zero „0“ (no longer bit error). The highest BER, which can be displayed, is  $1 \times 10^{-2}$ . Generally, it can be assumed, that picture disturbance can occur by a BER of ca.  $1 \times 10^{-3}$ .

## Measurement of modulation error rate (MER)

In the DVB measuring guidelines, the measurement size is determined, which are combined with the broad interfering influences. The MER is calculated to record the entirety of the signal interference, which is available on the input of this receiver. It gives instructions regarding the ability of the receiver, to decode a signal correctly. The MER is the ratio of the average signal performance divided by the error power in dB. The higher the MER value is, the better the received signal is. Measurements of the MER can be displayed on the upper edge of the screen.

## Carrier offset

The carrier offset display shows the difference between the set receiving frequency on the MSK 33 and the transmission frequency of the digital signal in MHz.

With the help of the cursor buttons, ◀▶, you can switch to the next channel.

# Const Menu

## Frontend locked

If the receiving part of the MSK 33 is locked on the carrier frequency of the received signal, the display „Frontend locked“ appears on the screen. If a representation of the constellation diagram is not possible, the display „not locked“ is displayed.

An analysis of the constellation diagram or an evaluation of the measurement results can first occur, when the receiving signal is locked.

The modulation type and the symbol rate are to be correctly set. The inversion of the spectrum (invert / no) is set automatically.

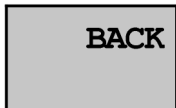

The last set menu is called up.

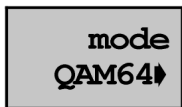

Switch-over between the modulation types QAM 64, QAM 128 or DOC64.



For DOCSIS64 BER cannot be displayed.

## Selecting the symbol rate (symbol-clock)

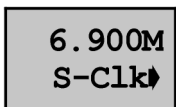

By pressing this button, you can select between the symbol rates, 6,900 MS, 6,111 MS, 6,952 MS or 6,875 MS . With the numerical buttons, entry between 0.5 and 7.2 MS is possible.

## Inverting /not inverting constellation diagram

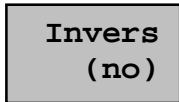

Display the status of the frequency spectrums or the constellation diagram. Setting automatically occurs.

## Zoom



Press this button to make the constellation diagram larger. The upper left section of the constellation diagram is now displayed and allows a closer glance of the single symbols. By pressing the button once more, the original size of the constellation diagram is displayed.

|   |             |           |
|---|-------------|-----------|
| BER: 1.7e-06  | MER: 29.5dB | BACK      |
| Carrier Offset  | 0.25 MHz    | mode      |
| Anzeige der Bit-Fehler-Rate, der Modulations-Fehler-Rate und der Trägerablage |             | QAM64     |
| Anzeige von Kanal-Nummer, Träger-Frequenz und Pegel (digital)                 |             | 6.900M    |
| Frontend: locked  |             | S-Clk     |
| S24   | 330.00MHz   | D49.0dBµV |
|   |             | equ on    |
|   |             | in on     |
|   |             | z o I I   |

The screen shows the following values:

- BER = Bit error rate: 1.7 e-06
- MER = Modulation error rate: 29.5 dB
- Carrier offset: 0.25 MHz
- Frontend locked = locked
- Carrier frequency: S24 330.00 MHz
- Digital measurement (D)
- Carrier level: 49.0 dBµV



# Const Menu

## Examples for QAM constellation diagram

The following examples show possible errors and their representation in the constellation diagram.

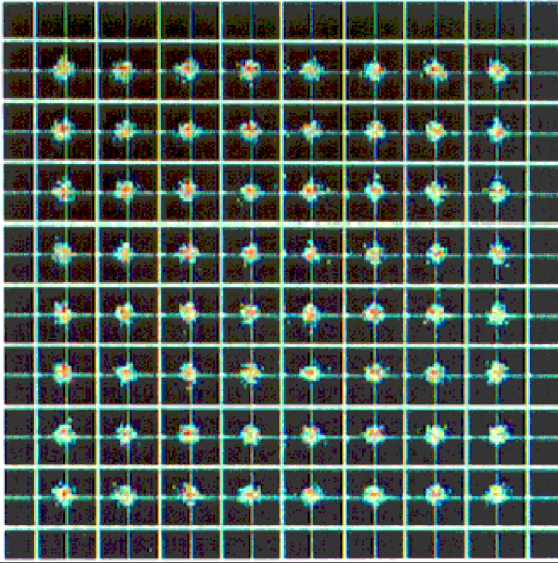

64 QAM signal without faults

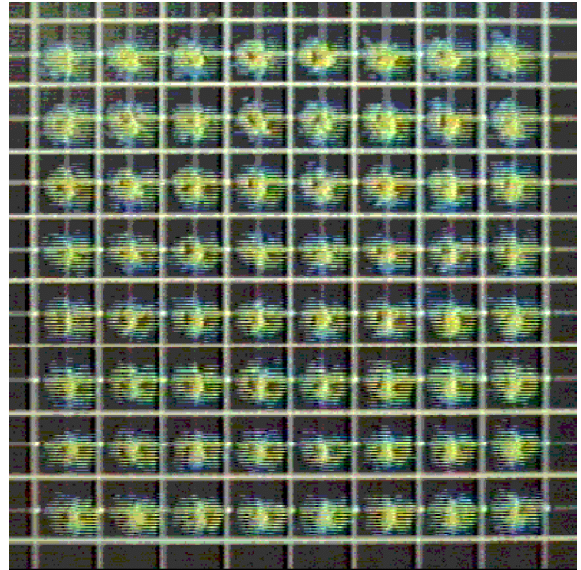

64 QAM signal with intermodulation of narrow band noise

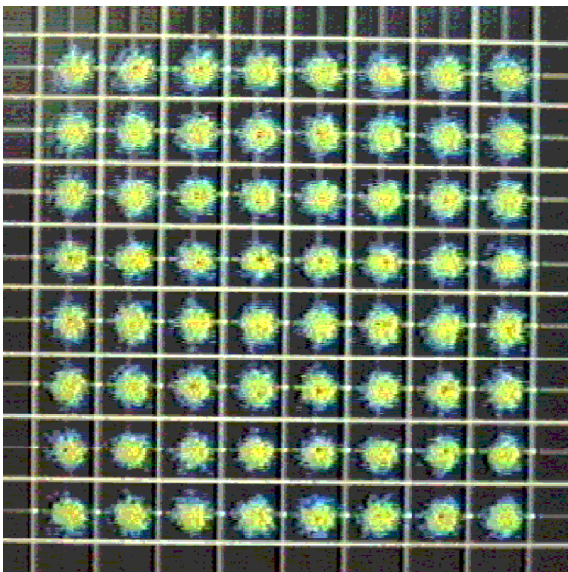

64 QAM signal with low broadband noise. Possible cause: Bad amplifier or too small of input level on an amplifier in the transmission line.

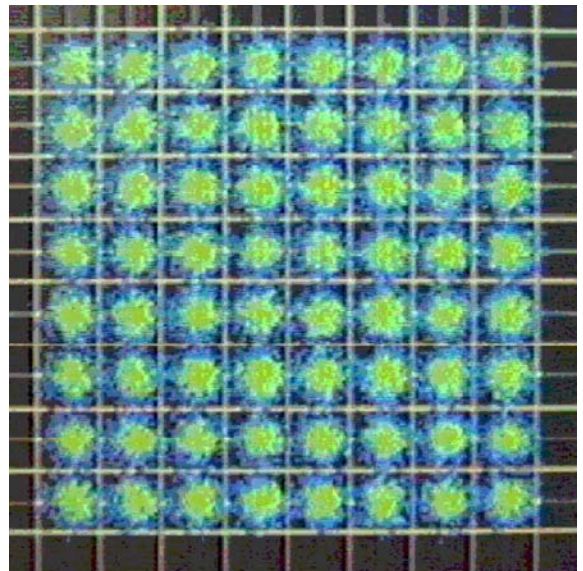

64 QAM signal with strong broadband noise. Possible cause: cable loss is too high or amplifier has a defect.



# Const Menu

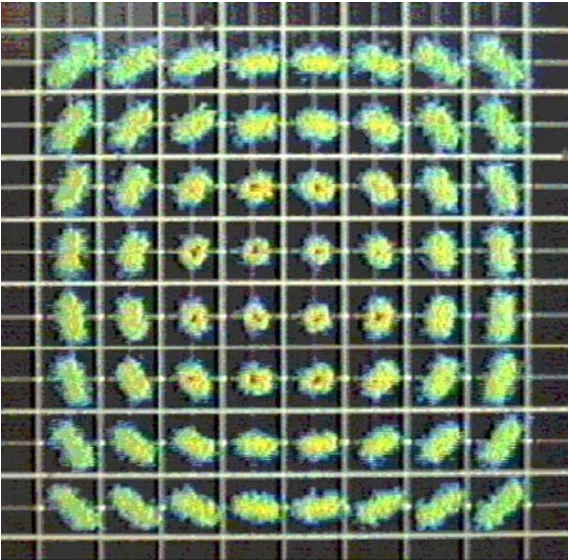

64 QAM Signal with phase noise of a converter

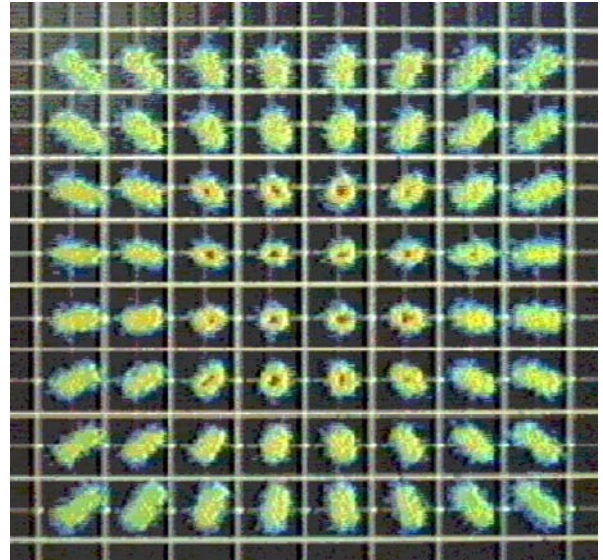

64 QAM signal with amplitude hum of an amplifier

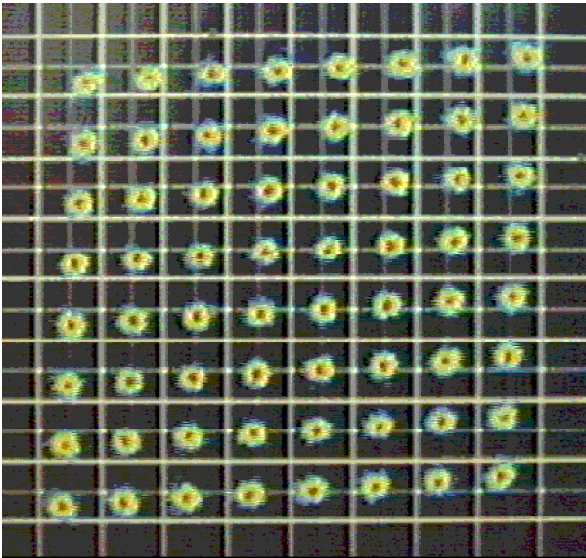

64 QAM signal with I/Q phase error of a converter

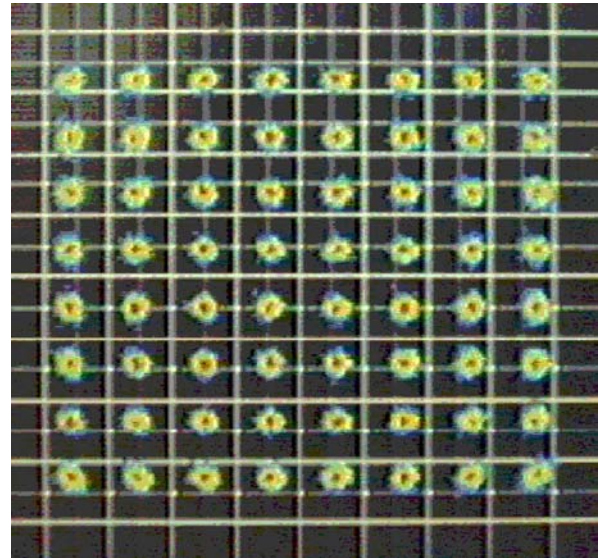

64 QAM signal with signal I/Q amplitude error of the converter

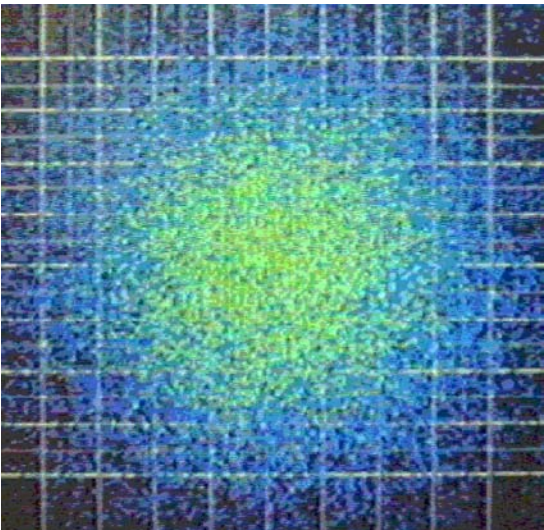

Unsynchronised demodulator- no input signal.

## Constellation diagram DVB-T (optional)

For the terrestrial digital transmission of television signals (DVB-T), the modulation type OFDM (Orthogonal Frequency Division Multiplex) is used.

In 2k mode, 1705 carriers and in 8k mode 6817 carriers either QPSK-, QAM16- or QAM64 are modulated.

DVB-T signals are transmitted in the so-called hierarchy modulation. Two MPEG transport streams of difference priority are simultaneously transmitted.

The demodulated QPSK signals are decoded in the MPEG decoder and their constellations are represented on the screen of the MSK 33.

THE MSK33 can automatically represent the constellations of all possible modulation types and display the respective values.

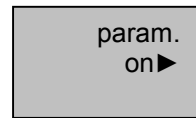
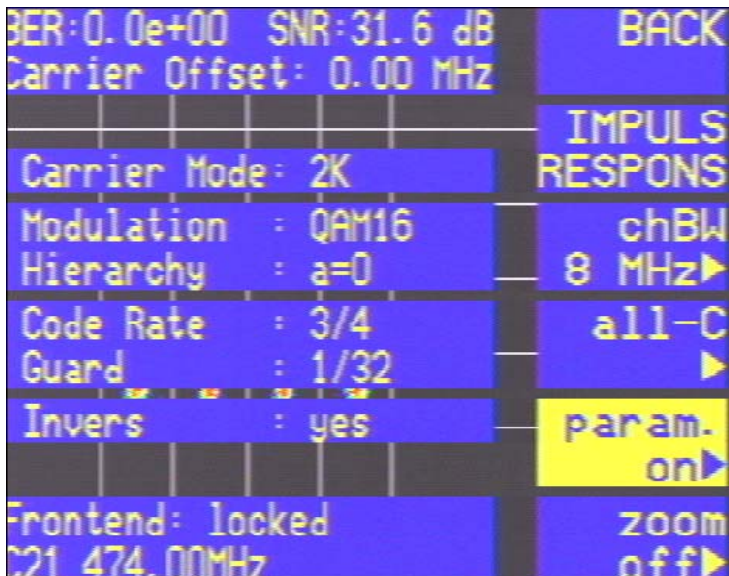

By pressing this softkey, you receive all data of the DVB-T signal (see left).

## Measurement of bit error rate (BER)

Since it deals with the transmission of binary data for DVB-T, the bit error rate can be observed as measurement for the occurring transmission error in the data stream. The BER measurement is carried out before the viterbi decoder and displayed on the screen. The bit error rate is the ration of the number of the received defective bits divided by the entire number of receive bits. The low bit

error rate, which the MSK 33 can measure, is  $1.0 \text{ e-}8$ . If the measured value is below this value, the display of BER skipped to zero „0“ (no bit error available). The highest displayed BER is  $1 \text{ e-}2$ . Generally, it can be assumed, that the picture disturbance can occur for a BER of ca.  $2.2 \text{ e-}2$ .

## Measurement of signal noise ration (SNR)

The conception of the MSK 33 allows the S/N ratio of the I- and Q- data stream to be displayed in addition to the C/N measurement on the digital carriers in the Const-menu. The measurement is carried out after the QPSK demodulation and can be called in as an indicator for the noise on the I/Q signals. Differences in the result to the C/N measurement in the spectrum menu can be caused by the complex interfering influences of the digital signal or by differences in the input level. The SNR value is displayed on the upper edge of the TFT screen.

The best value, which the MSK 33 can measure, is 32 dB.

## Carrier offset

The carrier offset display represents the difference between set receiving frequency on the MSK 33 and the transmission frequency of the digital signal in MHz. With the cursor buttons, ◀▶, you can switch to the next channel.

## Carrier mode

Displays how many carries of the DVB-T signal are modulated. It is modulated between the 2k mode (1705 carriers) and the 8k mode (6817 carriers).

## Modulation

Displays the modulation type, with which the DVB-T carriers are modulated. The modulation types QPSK, QAM16 and QAM64 are possible.



# DVB-T

## Hierarchy

Meaning: Two carriers streams are simultaneously transmitted and the transport stream with the higher priority is QPSK modulated.

There are four hierarchy steps (0, 1, 2 and 4).

Hierarchy = 0 means, that the signal is not hierarchy modulated.



Hierarchy = 1 means, that the signal is hierarchically modulated. Two transport streams are simultaneously transmitted, one has higher priority in QPSK.

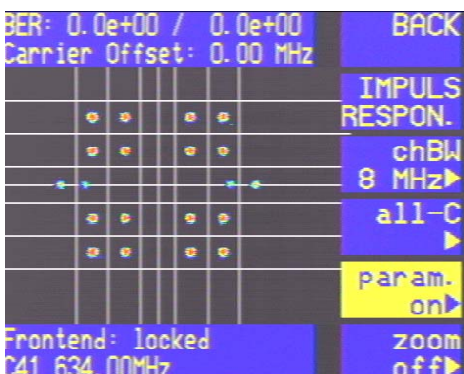

Hierarchy = 2 means, that the signal is hierarchically modulated. The modulation is compared to the QAM modulation is one step securer.

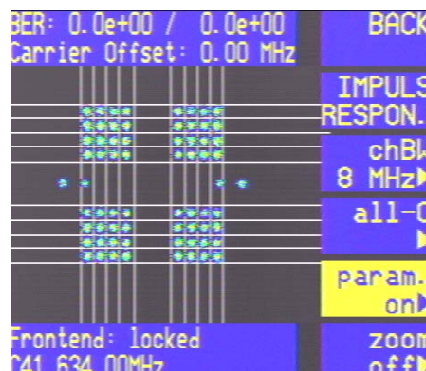
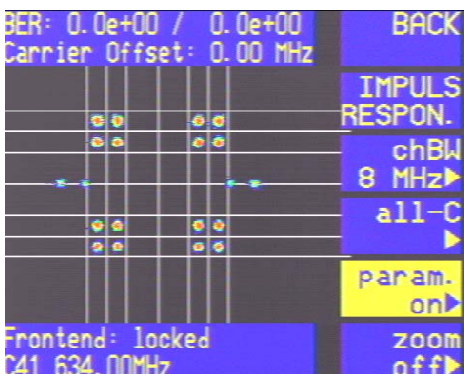

Hierarchy = 4 means, that the signal is hierarchically modulated. the QPSK modulation is securer that the QAM modulation by two steps.

# DVB-T

## Code rate

Display the measured code rate  $\frac{1}{2}$ ,  $\frac{2}{3}$ ,  $\frac{3}{4}$ ,  $\frac{5}{6}$  or  $\frac{7}{8}$ .

## Guard

Displays the ratio between guard interval and symbol time  $\frac{1}{4}$ ,  $\frac{1}{8}$ ,  $\frac{1}{16}$  or  $\frac{1}{32}$ .

## Invers

The display of the condition of the frequency spectrum or the constellation diagram. Setting occurs automatically.

## Frontend locked

If the reception part of the MSK 33 is locked on the carrier frequency of the received signal, the display „Frontend locked“ appears on the screen. In the opposite case, „not locked“ appears on the screen.

An analysis of the constellation diagram or an evaluation of the measurement results can be only carried out, when the receiving signal is locked in.

The channel width of the DVB-T channel (chBW = 6.7 or 8 MHz) must be manually set to the correct value with the respective softkey.

## Channel display



The received channel and the respective reception frequency is displayed. By pressing the cursor buttons, ◀▶, the channel can be changed.

The reception level can be displayed in the DVB-T-CONST menu.

The channel bandwidth can be selected between 6 MHz, 7 MHz and 8 MHz.

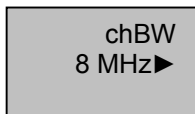

Selection of the representation of all available OFDM carriers.

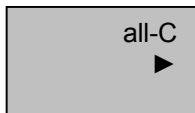

By pressing on the button „all-C“ once more, you can enter in the starting carrier.



By pressing this button again, you can enter in the stop carrier.

You can select a carrier range or select the representation of a signal carrier by identical entry of the starting or stop carrier.



Pilot carrier in 2k mode:

34, 50, 209, 346, 413, 569, 595, 688, 790, 901, 1073, 1219, 1262, 1286, 1469, 1594, 1687

Central carrier in 2k mode: 852

Pilot carrier sin 8k mode:

34, 50, 209, 346, 413, 569, 595, 688, 790, 901, 1073, 1219, 1262, 1286, 1469, 1594, 1687, 1783, 1754, 1913, 2050, 2117, 2273, 2299, 2392, 2494, 2605, 2777, 2923, 2966, 2990, 3173, 3298, 3391, 3442, 3458, 3617, 3754, 3821, 3977, 4003, 4096, 4198, 4309, 4481, 4627, 4670, 4694, 4877, 5002, 5095, 5146, 5162, 5321, 5458, 5525, 5681, 5707, 5800, 5902, 6013, 6185, 6331, 6374, 6398, 6581, 6706, 6799

Central carrier in 8k mode: 3408

# DVB-T

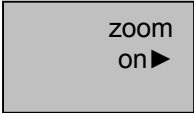

Press this button to enlarge the constellation diagram. The upper left-hand section of the constellation diagram is now represented and allows a closer look of signal symbols. By pressing the button again, the original size of the constellation diagram is represented.

## Impulse response representation (Echo representation) (optional)

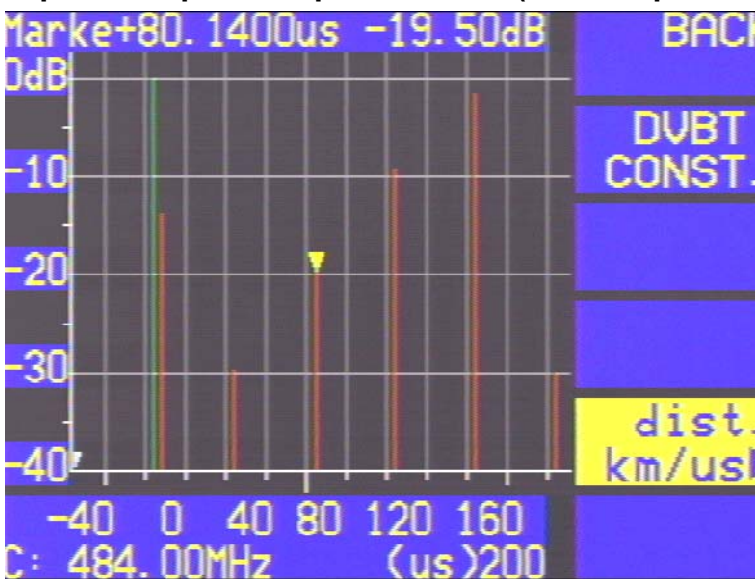

By means of the impulse response representation, it is possible to measure echoes in the transmission path or multiple path reception. The green line (on the left in the screen to dB) represents the received used carrier. The other (red) lines are echoes. For multiple path reception, pre-echoes can also occur, if an unwanted transmitter has a shorter distance to the receiver as desired.

With the button „dist. km/μs,“ you can switch the measurement between running time and distance.

With the cursor buttons, ◀▶, you can move the yellow marker for measuring the distance or the time and the level of reflection.

Echo representation: marker display in μs

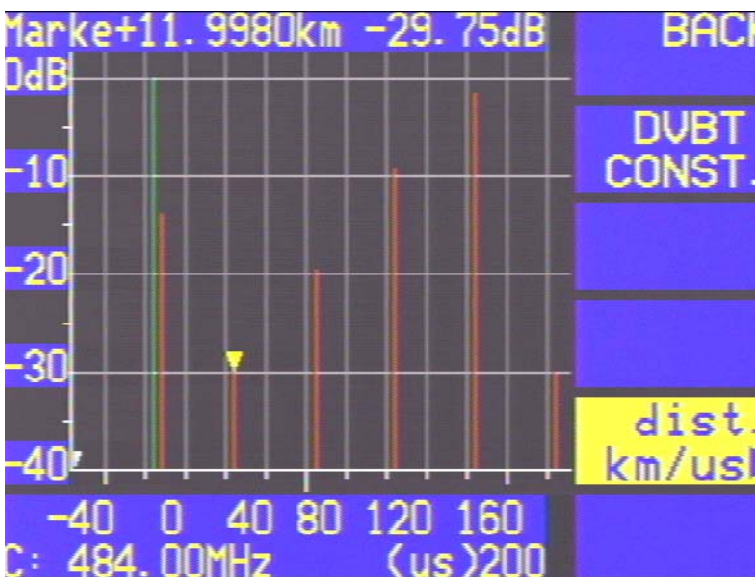

Echo representation: marker display in km

# Broadband Cable Analysis Measuring System MSK 33 / MVG

The broadband cable analysis system consists of the antenna measuring instrument MSK 33 (including return path option) and the signal generator MVG 10.

Both units function in the frequency range from 4.0 MHz to 860 MHz.

It allows the measurement of cable systems in CATV range (downstream) and in the return path range (upstream).

The measurement can also be carried out in the supplied cable.

The signal generator MVG 10 can wobble in many segment ranges, which means that ranges which are occupied can be locked by the generator, thus allowing TV reception not to be disturbed.



Therefore, before the measurement, make a frequency and level plan! The MVG 10 requires a bandwidth of ca. 500 kHz for transmitting the telemetric data, which means, that the set frequency points must have at least a distance of 250 kHz from the used signal on the cable system, provided the amplitudes of the used signal and MVG 10 signal are the same.

Before each frequency change, the MVG 10 transmits the next reception frequency to the MSK 33 via a telemetric signal. In occupied ranges, which must not be swept, the MSK 33 can carry on the measurements in the same raster with maximum scanning speed. During this time, the MVG 10 pauses. The MSK 33 measures the transmitted level and represents in the spectrum. the measurement can be printed out via the built-in printer.

## Measuring principle

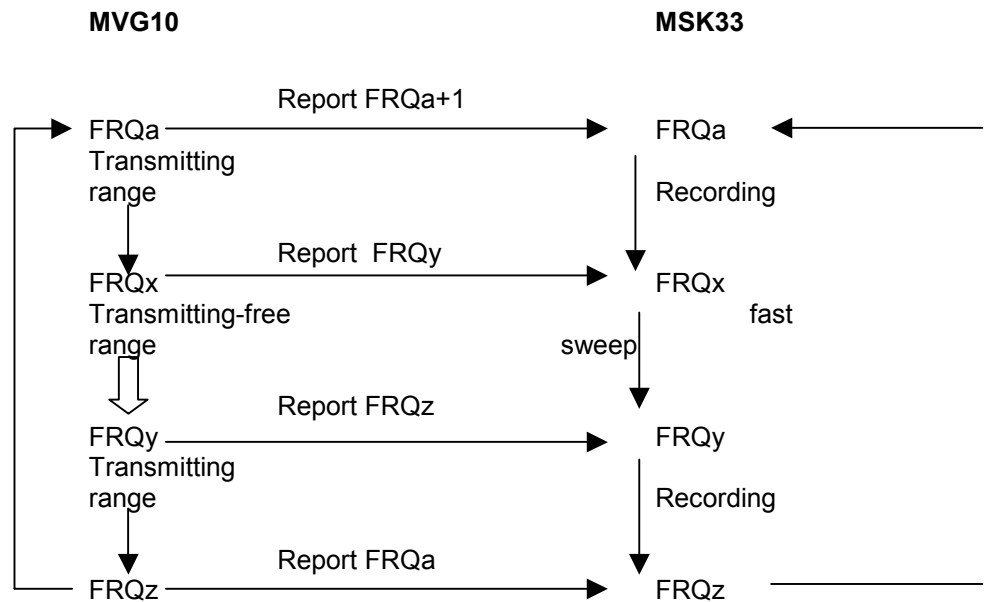

MVG10



CATV system  
upstream  
or  
downstream





# Broadband Cable Analysis Measuring System MSK 33 / MVG

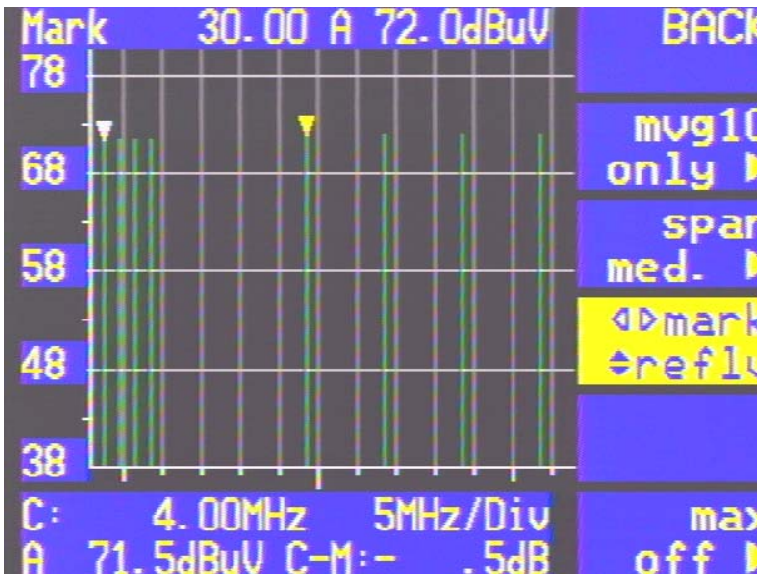

First select the reception frequency in the reception menu TV or RP. With this, the MVG 10 begins to „sweep.“

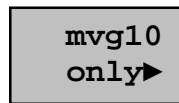

From the MODE menu, man reaches track. MVG 10 the spectrum display in MVG 10 tracking mode with the second softkey.

In this mode, all MVG signals in respect to the frequency and level are recorded from the starting frequency up to the end frequency. In between, laying signals are not recorded. In this mode, the highest measuring speed can be reached (ca. 160 ms per represented spectral line).



The less frequency points (spectral lines) you define for the MVG 10, the faster the spectrum representation of the MSK 33 in „MVG 10 only-mode“ works. Therefore, enter in only required frequency points for the MVG 10.

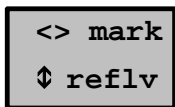

With the cursor buttons, ◀▶, the position of the yellow marker can be determined for frequency and level measurement. Frequency and level of the yellow marker is displayed. By pressing the cursor buttons, ▲▼, the reference level can be changed in 4 dB increments (the spectrum is moved up or down). Refer to the respective chapter “Spectrum Analysis”!



By pressing this button, the represented frequency range can be defined per scale part. Refer to the respective chapter “Spectrum Analysis”!

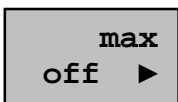

By pressing this button, the spectrum is switched to „Max hold.“ By repeatedly pressing this button, it switches again to ‚clear write‘.



In this menu, press the buttons only very slowly, since the MSK 33 in this mode always waits for the data reports of the MVG 10. Therefore, press the buttons for a longer time until the MSK 33 reacts.

The red LED above the RF input lights up on MVG tracking mode. This does not mean anything. There is not voltage on the RF input.

In this mode, all MVG signals in respect to frequency and level from the starting frequency to the end frequency are recorded.

In-between laying signals are also recorded. The signals sent by the MVG 10 are displayed in green (depending on the measurement bandwidth green/red). The spectrum between the MVG 10 signals are displayed in red.

In this mode, the step-time must be increased for the MVG 10 (each according to the set span ca. 700...5000 ms pre represented spectral line). Also, refer to the operating manual MVG 10.

The measured spectrums can be printed out via the function COPY - print data.

# Broadband Cable Analysis Measuring System MSK 33 / MVG

A few functions such as „Clear display,“ „Printout the spectrum“ (prt 123) and switch-over functions can be remotely controlled via the MVG 10. Refer to the operating manual MVG 10!

## Comfortable upstream 4.0...80 MHz and Downstream 47...860 MHz measurement

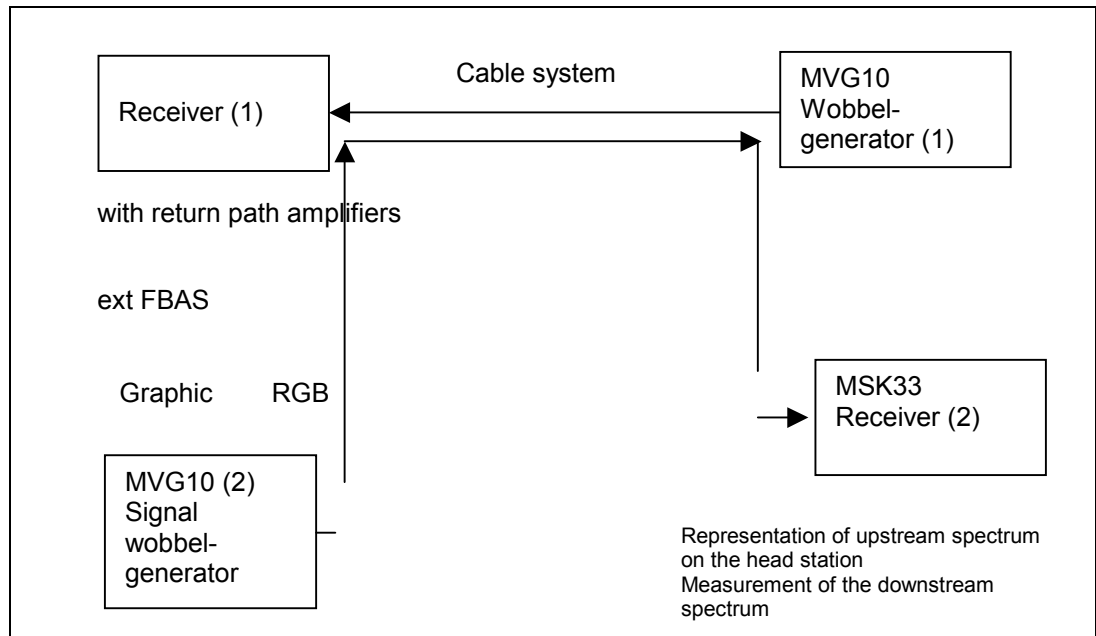

### Upstream measurement

The MVG 10 (1) wobbulates in free frequency ranges in the return path.  
The MSK 33 (1) receives the signals in the MVG 10 tracking mode.  
The graphic of the MSK 33 (1) is given to the MVG 10 via a SCART cable in RGB (60 Hz) and transmitted to the MSK 33 (2) on a free downstream channel (attention two-sided band modulation!).  
With the aid of the print command „Prt 999“ on the MVG 10 (1), the spectrum can be printed out on the head station from the MSK 33 (1).  
The command „Clear“ clears the spectrum representation on the MSK 33 (1).

### Downstream measurement

#### Preparation

First, the signal generator with external RGB modulation must be stored on the memory position „0“ of the MVG 10 (2) and the channel sweeper with the desired channel sweep ranges must be stored on the memory position „1.“

With the command „Fkt A 1“ from the MVG 10 (1), the MVG 10 (2) is switched over via the MSK 33 (1) from the signal generator mode to the downstream sweep generator mode.  
The MVG 10 (2) wobbulates the forward path in free frequency ranges.  
The MSK33 (2) receives the signals in MVG 10 tracking mode.  
With the command „Fkt A 0“ from the MVG 10 (1), the MVG 10 (2) can be reset into the signal generator mode. This occurs via the switching voltage of the SCART line.  
Uscart = 12 V produces Recall no. 1 on MVG 10.  
Uscart = 0 V produces Recall Nr. 0 on MVG 10

# Broadband Cable Analysis Measuring System MSK 33 / MVG

Retransmission of the spectrum received by the MSK 33 (1) with a MVG 10 (2).

It is possible to transmit the received spectrum on the head station or a FBAS signal of an external unit (camera, head station computer etc.) via the MVG 10 (2) on free CATV channels. Here, the MSK 33 is connected to the MVG 10 with the fully occupied Scart cable.



Please make sure, that the MVG 10 is two-sided band modulated.

Therefore, you need two free RF channels for picture transmission.

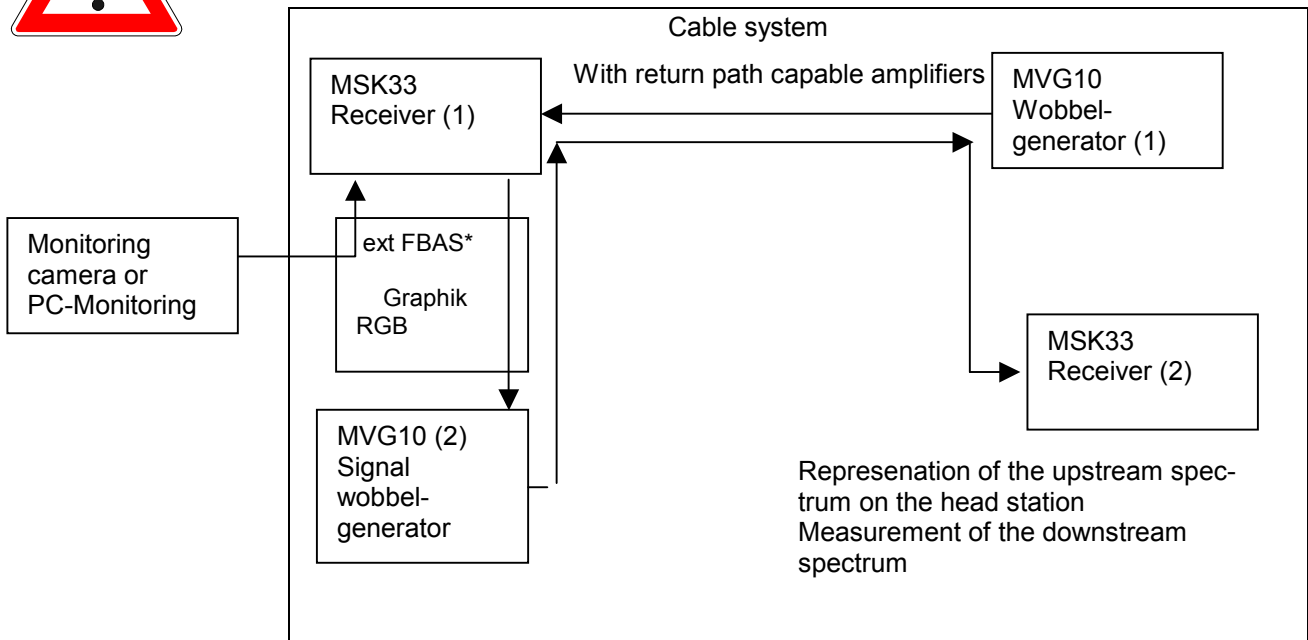

\* In case you want to additionally transmit a CVBS signal via the MVG 10 (2) in this measurement arrangement, you must change the SCART cable between MSK 33 (1) and MVG 10 (2) as follows:

- Separate the cable from Pin 20 (Video in) on the SCART cable plug, which is connected with the MSK 33.
- Connect a shielded 75 ohm cable with a Cinch connector on the other end on PIN 20 (Video in).
- Connect the screen of the cable with PIN 17 (video earth).

The MSK33(1) converts the fed-in video signal into a RGB signal and delivery this signal for modulation on the MVG10(2).

The switching occurs via the MVG 10 (1) function Fkt B 0/1

Graphic transmission = Fkt B 1

ext. FBAS = Fkt B 0

Refer to the operating manual MVG10.

# Auto Measure

|  |                  |
|--|------------------|
| measurement point >48<<br>!after start is point +1 | BACK             |
| list rcl. ---setting---<br>1 >85< NO SETTINGS      | edit<br>list     |
| 2 02<br>3 03                                       | set<br>point     |
| 4 04<br>5 05                                       | stop<br>on/off   |
| 6 06<br>7 07                                       | start<br>measure |
| 8 08<br>9 09                                       | input<br>listNo  |

In the setting, AUTO MEASURE, the measuring instrument settings which are saved in the ,Copy menu can be carried out and printed out.

For the automatic measuring sequence, the unit settings (store nr. -- / recall nr.-) which are saved in the ,Copy menu' are used. Refer to the chapter "COPY Function". Up to 100 (00...99) different series of measurements can be saved. You can assign each measurement sequence a specific check point (e.g. socket 1), but the memory positions 80...95 are occupied with DiSEqC functions at the factory.

## Display of the check point

measurement point >02<  
after start is point+1

set  
point

The upper bar of the display screen shows, which check point assigned to the measurement sequence is called up. It can be reprogrammed via the softkey, set point, and numerical entry from 00 to 99. For each new start of measurement, the check point number is automatically increased by 1.

With „set point,“ you open the numerical entry of the check point via the numerical keypad.

## Display of the entry field for the respective measurement task

list rcl. ---setting---  
5 >08< TsA 303.25M

edit  
list

stop  
on/off

start  
measure

input  
ListNo

list 5 = Measurement sequence number  
rcl. >08< = Entry of the memory position number of the measurement setting after pressing the button „edit list“ setting  
TsA 303.25M = TV special channel analogue 303.25 MHz

After pressing this softkey, the memory position number of the measurement, which is to be carried out, can be entered in for the respective measurement sequence number.

This softkey indicates the end of the measurement sequence.

After pressing this button, the automatic measurement sequence starts. All measurement settings are carried out between the measurement sequence number 00 and the next STOP or between two STOP settings and afterwards the measurement results are printed out with the built-in printer.

After activating this softkey, the numerical entry of the list number can be carried out or the entry point (list number) selected with the cursor buttons, ▲ ▼.



# Interfaces

## Modem / RS 232 interface

The serial interface RS 232 is executed as 25-pin SUB-D socket. It is required for controlling the MSK 33 via modem, or PC.

## Connection cable for modem / RS 232

In order for the MSK 33 to be able to be remotely controlled via the RS 232, a connection between the signal meter and the PC or external modem must be established. If a modem is used, this connection occurs with a RS 232 interface cable, which connects the modem with the RS 232 socket on the rear panel of the MSK 33 1 : 1.

If a PC is directly connected, a so-called zero modem cable must be used. Here next to the transmitting and receiving wire, all handshake wires are also crossed.

**Note:** For deactivating the handshake operating on the MSK 33 (see below), it is sufficient to use a zero modem cable, in which only the TXD wire and the RXD wire are crossed. However, the operating software of the MSK 33 works faster, if the handshake operation is activated (especially, if no modem is connected). The MSK 33 first answers without handshake after the entry of a RETURN on the PC.

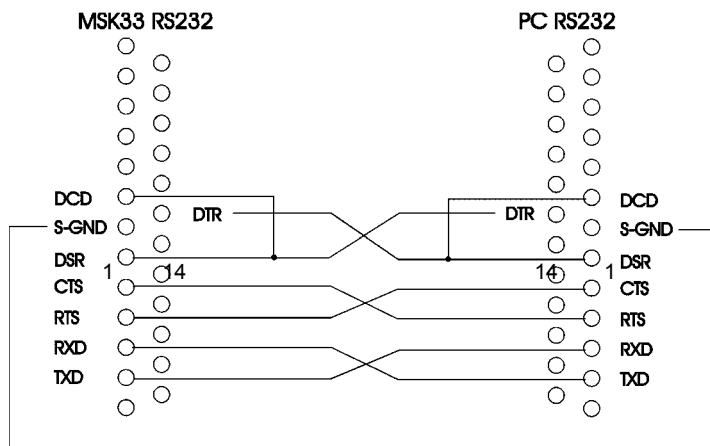

of the MSK 33 works faster, if the handshake operation is activated (especially, if no modem is connected). The MSK 33 first answers without handshake after the entry of a RETURN on the PC.

Connection assignment of the zero modem cable for the remote control of the MSK 33 via a PC.



```

----- R S 2 3 2 -----
DSR: on  DCD: on  CTS: on
    
```

Anzeige im MODEM-Menü

If the MSK 33 is directly connected with the PC, it is represented in the upper display field in the ,modem menu,' if the zero modem cable is properly connected. All three displays (DSR, DCD and CTS) must show the message „ON“. Many zero modem cables have no connection with the DCD connection of the RS 232 connector. If so, the display ,OFF' appears near the DCD. In this case, a bridge from DSR to DCD must be provided in the connector of the zero modem cable (refer to illustration) or the handshake operating must be switched off.

## Modem/RS232 menu

|   |                      |
|---|----------------------|
| -----R S 2 3 2-----<br>DCD: on DSR:off CTS:off    | BACK                 |
| BAUDRATE:      FORMAT:<br>19200 baud    (8N1) fix | rate<br>←→           |
| -----MODEM-----                                   | echo<br>off          |
| INIT = AT&F1&DOS0=1<br>PIN1 = -MSK-33-            | r/cts<br>off         |
| PIN2 =<br>PIN3 =                                  | init<br>↑<br>←→<br>↓ |
| MODEM   | fact.<br>Setup       |

The RS232 interface of the MSK 33 can be configured in the most important points in this menu.

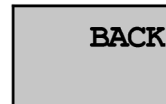

Return to the ,SETTING menu.'

### Setting baud rate



The field lights up yellow, as soon as the softkey is pressed. Afterwards, the interface speed from 2400 to 115200 baud (each 8 bits / no parity /no stop bit) can be set with the aid of the cursor buttons, „<“, and „>“. This setting is only based on the interface communication between the modem and the MSK 33 and has no influence on the transmission characteristic data of the modem.

### Setting local echo

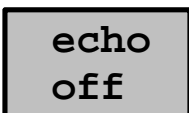

Normally, all characters received by the modem are sent back by the MSK 33. This means, that a character entered in on the terminal (PC keyboard) is not immediately displayed on the screen, but rather sent via the near modem (on the PC) to the farther modem (on the MSK 33). Here, the character is analysed and sent back (echo function).

If the local echo on the terminal is activated, the character appears twice and one of the both echoes must be terminated.

### Setting hardware handshake

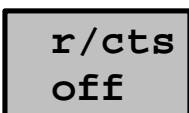

By pressing the button, R/CTS, the hardware-handshake can be activated or deactivated. If the handshake operation is deactivated, it is not possible for the MSK 33 to recognise, when a connected PC or modem has taken over the operation. In this case, the MSK 33 first answer after entry of a RETURN on the terminal programme.

If the handshake is activated, this occurs automatically, as soon as the terminal programme has been called up or the modem has been successfully called. If the MSK 33 is switched off during this procedure, it will switch on by itself or switch off after exiting the terminal programme or loss of the carrier on the modem.

### Init (Initialisation string) for the MSK 33 modem

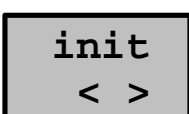

Here, the currently valid initialisation string for the MSK 33 modem can be read. With the aid of the initialisation string, a connection to the MSK 33 modem is established after switching on the MSK 33. With this, a change of the basic setting in the modem is carried out, for example the setting of a common baud rate. A change of the initialisation string can occur after pressing the INIT button. Hereby, it is possible to select the character with the cursor buttons, or to select the position which is to be edited. The character string is sent to the first space after deactivating the INIT button.

# Interfaces

**FACT.  
SETUP**

After pressing this button, the MSK 33 is reset to the factory setting.

## Code (Password)

Here, the currently valid password can be read, which must be known by the user for the remote request or control of the MSK 33. The password can only be changed in active modem operation.

**INIT =**  
**PIN1 =**

### **PIN1**

is the master PIN and opens all functions of the MSK 33 (including download of the unit software). Just in case, you should not register yourself under this PIN, in order to avoid overwriting the programme software (other safeties are built in).

### **PIN2**

opens all function of the MSK 33 with the exception of locking the programme memory and the new programming of programme memory. The important settings on the MSK 33 can be remotely controlled with this.

### **PIN3**

allows one to only receive measurement values from the MSK 33. The changing of important settings is not possible after login in under this PIN.

Note: For changing a PIN (only possible via RS232), the PIN is always taken over, under which you have logged-in with.

**PIN2 =**  
**PIN3 =**

Passwortanzeige im MODEM- Menü

## Operating of the MSK 33 via modem

The MSK 33 can be remotely controlled in two terminal modes. It is distinguished between the TTY mode and the ANSI mode.

### The TTY mode

The TTY mode is line-orientated and complies for the most part with the usual operation via a serial interface or a modem. This means, the command abbreviations are entered in via the keyboard, interpreted by the MSK 33 and the command is appropriately executed. MSK 33 confirms the execution of the commands with text information- After each command, the screen is scrolled up line-by-line. This method is used in general for the automation of measurement tasks. A written measurement programme from the user cyclically calls up certain commands of the MSK 33 and analyses measurement values sent by the MSK 33.

### the ANSI mode

In ANSI mode, it is possible for the MSK 33 to generate a intuitively easy to use surface by simple control characters on the controlled page, which is in the SAA standard under DOS. A advantage of this method is that any terminal programme for controlling the MSK 33 can be used (e.g. Term95, Telemate, Hyperterminal etc.). The installation of a separate control software on the PC is not necessary. Other control computers can also be used as well. Here, The available control characters in ANSI standard are fallen back upon a subset.

### The log-in procedure

The MSK 33 responds to the user with the request of the password (PIN), after a carrier has been recognised on the modem or for deactivation of the handshake after the entry of RETURN on the terminal programme. If no PIN is available (all positions of the respective PIN in the modem menu of the MSK are highlighted yellow), here RETURN must be pressed once more for confirmation.

# Interfaces

## Requesting help

In the TTY mode, the list of the available commands can be requested with the question mark. In this list, the first three letters are capitalised, which should indicate that it concerns a key abbreviation. The entry of the first three characters the command (occurs with RETURN) is here sufficient to trigger the respective command. If it concerns commands without parameter entry (calling up measurement values or switch-over of specific modes etc.), the command is switched off. For commands with parameter entry e.g. FRE (for receiving frequency entry), the request of the frequency appears after the command abbreviation by the MSK 33. It is also possible to add the parameter (here the frequency) to the command abbreviation as an attachment (separated by a space). Example FRE 266.25 MHz.

The command must be here entered in with a point. Units are proposed as default and must only be added for a difference. Example FRE 10.7 G means 10700 MHz, FRE 10.7 however 10.7 MHz. It is sufficient to type in the first letters of the unit

In ANSI mode, context-sensitive help is switched on. This means, that the user receives notes concerning the command selected from the pulldown menu, which appear on the lower section of the screen.

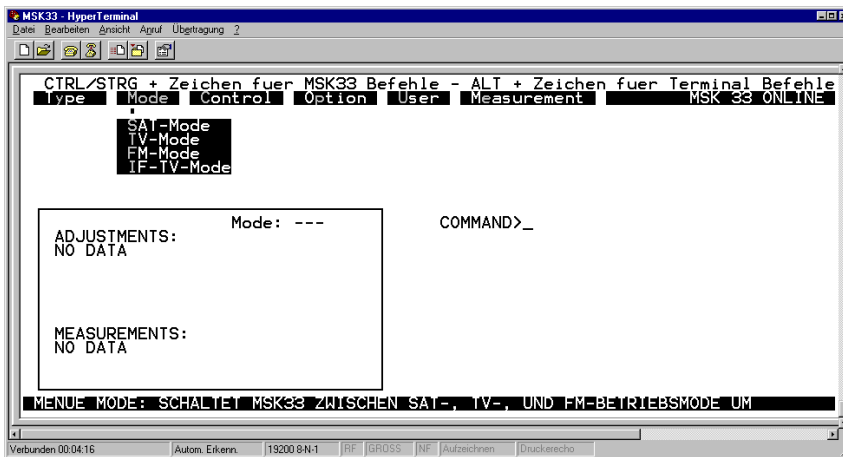

### Example for logging-in in ANSI mode

In ANSI mode, it is possible, to type in the commands, like in TTY mode) as command abbreviations, to select the commands from the pulldown menus with the cursor buttons or to call up the commands via the button combinations.

In order to select from the pulldown menus, any cursor button must simply be pressed. Now with the cursor buttons, the menu can be selected (left-right cursor) or the command in the menu (up-down cursor) can be selected and with RETURN the selection can be confirmed. The pulldown menu can be opened with the CONTROL + highlighted cipher, in order to then select a command with the highlighted letter. Example: For frequency input, press CONTROL + C and afterwards F.

# Interfaces

Note: Alt + S + cipher is in general base on functions of the respective terminal programme.

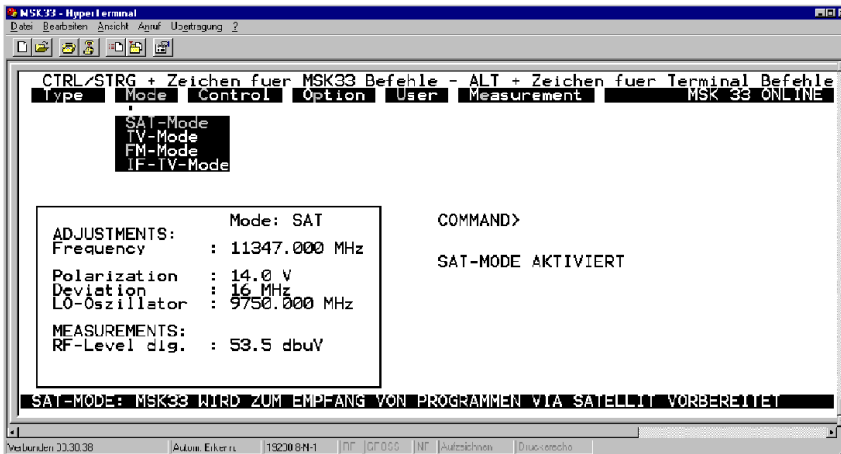

The picture of the left shows an example of a pull-down menu. On the left of the picture, there is a frame for entering parameter-afflicted commands, which represents a summary of current unit setting.



Example: Entry of the LNB oscillator frequency



# Interfaces

| <b>Loading and saving predefined settings</b> |   |   |
|---|---|---|
| STU   | Saving of the current unit setting under a user-defined programme position number from 00-99. |   |
|   | Entry:  | Action:   |
|   | STU <RET>   | You are asked for the programme position, under which the unit setting should be saved. |
|   | STU 34 <RET>  | Current setting is saved on the programme position 34.                                  |
| LDU   | Loading the setting by the identified programme position number 00-99.                        |   |
|   | Entry:  | Action:   |
|   | LDU <RET>   | You are asked for the programme position, from which the setting should be downloaded.  |
|   | LDU 34 <RET>  | The setting is loaded from programme position 34.                                       |

## Maintenance

The maintenance of the unit is confined to cleaning the interior and exterior of the unit.

### Unit calibration

The calibration interval depends on the use and demand, and should be made every 1 and 2 years. The calibration can be carried out by the KATHREIN customer service centre (see below).

### Exterior cleaning

The exterior of the unit is cleaned when needed with a soft, not fibrous dusting rag or brush. For very dirty areas, a spirit or mild soap agent can be used. Never use solutions such as nitro-thinner, acetone etc, because these could damage the writing on the front panel or the plastic parts.

### Interior cleaning

The unit should be regularly dusted in the exterior every 1 to 2 years to ensure adequate ventilation. The cleaning interval depends on the amount of dust of the operating space. The housing cover is removed for cleaning the interior of the unit. The dust can be removed with the brush or with compressed air.

## Function testing

It is recommended to check the given required data in the measured time intervals. The data and its tolerances are taken from the data sheet.

Required means of measurement:

- TV / Sat test signal generator e.g. Grundig VTG 700
- DVB test signal generator e.g. Rohde & Schwarz SFQ

## Exchange of components

The modular construction principle of the MSK 33 allows an exchange of components by the user. Contact our service centre before each component exchange.

## Storage

The storage temperature range of the unit is: -40...+70°C.

When the unit is stored for a longer period of time, it should be protected from dust.

## Customer service

Send the unit to the following address for servicing and calibrating:

Fa. ESC

Kathrein Zentralkundendienst

Bahnhofstr. 108

D-83224 Grassau

Tel.: 08641/9545-25

Fax: 08641/9545-35

E-Mail: ESC-Grassau@t-online.de



## Printer paper-exchanging the ribbon

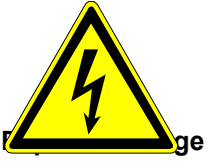

**Before opening the unit, disconnect the supply voltage.**

Remove the housing cover of the MSK 33. The housing cover is attached with four screws. After opening the unit, take out the axle with the empty paper roll. Insert the beginning of the paper of the new roll into the paper slot of the printer (between plastic and metal), then press down the button „LF - linefeed“ in the ‚COPY menu‘ until the beginning of the paper appears on the top side of the printer. Now, attach the paper roll with the axle into the paper container. Feed the beginning of the paper into the slit in the cover and secure the cover with the screws.

### Ribbon exchange

After removing the housing cover, the ribbon cassette is lifted up and removed by pressing the marking PUSH. the new ribbon cassette is positioned between the tensioned ribbon and the ribbon cassette. Feed the beginning of the paper into the slit in the cover and secure the cover with the screws.

## Overview of DiSEqC commands

### Command overview framing byte

| Hex-byte | Description  |
|----------|--|
| E0       | Commando from master, one time transmission                  |
| E1       | Commando from master, repeated transmission                  |
| E2       | Commando from master, answer expected, first transmission    |
| E3       | Commando from master, answer expected, repeated transmission |
| E4       | Answer from slave, „OK“, no error detected                   |
| E5       | Answer from slave, commando is not supported by slave        |
| E6       | Answer from slave, parity error is detected                  |
| E7       | Answer from slave, commando not recognised                   |

### Command overview address byte

| Hex-byte | Description  |
|----------|--|
| 00       | All units  |
| 10       | Each LNB, Matrix or SMATV  |
| 11       | LNB  |
| 12       | LNB with loop-through  |
| 14       | Matrix (Switcher)  |
| 15       | Matrix (Switcher) with loop-through                              |
| 18       | SMATV  |
| 20       | Every polarizer  |
| 21       | Full skew for linear polarisation                                |
| 22       | Polarizer gradually set  |
| 30       | Every positioner   |
| 31       | Polar / azimuth positioner                                       |
| 32       | Elevation positioner   |
| 33       | Combined positioner  |
| 34       | LNB positioner   |
| 40       | Installations-help   |
| 41       | Signal strength setting-help                                     |
| 60       | Reserved for assigned addresses                                  |
| 70       | „Intelligent slave interface“ for „Proprietary Multy-Master bus“ |
| 71       | Interface for subscriber and controlled head ends                |
| Fx       | CEM extension  |

# Technical Appendix

## Command overview command byte

| Hex-byte  | Command identification | Description  | Number Data/ Byte |
|-----------|------------------------|--|-------------------|
| <b>00</b> | <b>Reset</b>           | <b>Reset DiSEqC minicontroller</b>   | -                 |
| 01        | Clr. Reset             | Reset flag clear   | -                 |
| 02        | Standby                | Switches off the peripheric power supply unit                                    | -                 |
| 03        | Power on               | Switches on the peripheric power supply unit                                     | -                 |
| 04        | Set Contend            | Sets the contention flag   | -                 |
| 05        | Contend                | Feedback only when contention flag is set  | -                 |
| 06        | Clr. Contend           | Clears contention flag   | -                 |
| 07        | Adresse                | Feedback only when contention flag is not set                                    | -                 |
| 08        | Move C                 | Which address when contention flag is set  | 1                 |
| 09        | Move                   | Which address when contention flag is not set                                    | 1                 |
| 10        | Status                 | Reads status-register flags  | -                 |
| 11        | Config.                | Reads configuration flags  | -                 |
| <b>14</b> | <b>Switch 0</b>        | <b>Reads switching status flags (committed port)</b>                             | -                 |
| 15        | Switch 1               | Reads switching state flags (uncommitted port)                                   | -                 |
| 16        | Switch 2               | Expansion option   | -                 |
| 17        | Switch 3               | Expansion option   | -                 |
| <b>20</b> | <b>Set LO</b>          | <b>Calls up the low local oscillator frequency</b>                               | -                 |
| 21        | SET VR                 | Calls up the vertical polarisation or circular polarisation , clockwise          | -                 |
| <b>22</b> | <b>Set Pos A</b>       | <b>Selects satellite position A</b>  | -                 |
| 23        | Set S0A                | Selects switch option A  | -                 |
| <b>24</b> | <b>Set Hi</b>          | <b>Calls up the high local oscillator frequency</b>                              | -                 |
| 25        | Set HL                 | Calls up the horizontal polarisation or circular polarisation, counter-clockwise | -                 |
| <b>26</b> | <b>Set Pos B</b>       | <b>Selects satellite position B</b>  | -                 |
| 27        | Set S0B                | Selects switch option B  | -                 |
| 28        | Set S1A                | Calls up matrix S1 input A (input B inactive)                                    | -                 |
| 29        | Set S2A                | Calls up matrix S2 input A (input B inactive)                                    | -                 |
| 2 A       | Set S3A                | Calls up matrix S3 input A (input B inactive)                                    | -                 |
| 2 B       | Set S4A                | Calls up matrix S4 input A (input B inactive)                                    | -                 |
| 2C        | Set S1B                | Calls up matrix S1 input B (input A inactive)                                    | -                 |
| 2D        | Set S2B                | Calls up matrix S2 input B (input A inactive)                                    | -                 |
| 2E        | Set 3SB                | Calls up matrix S3 input B (input A inactive)                                    | -                 |
| 2F        | Set S4B                | Calls up matrix S4 input B (input A inactive)                                    | -                 |
| 30        | Sleep                  | All bus-commands are ignored except „Awake“                                      | -                 |
| 31        | Awake                  | Bus-commands are accepted again  | -                 |
| 38        | Write N0               | Sets port group 0  | 1                 |
| 39        | Write N1               | Sets port group 1  | 1                 |
| 3A        | Write N2               | Expansion option   | -                 |
| 3B        | Write N3               | Expansion option   | 1                 |
| 40        | Read A0                | Reads analogue value A0  | -                 |
| 41        | Read A1                | Reads analogue value A1  | -                 |
| 48        | Write A0               | Sets analogue value A0   | 1                 |
| 49        | Write A1               | Sets analogue value A1   | 1                 |
| 4F        | Write A7               | Sets analogue value A7   | 1                 |
| 50        | LO string              | Reads current frequency  | -                 |
| 51        | LO now                 | Reads current frequency (Table entry number)                                     | -                 |
| 52        | LO Lo                  | Reads low frequency table entry number   | -                 |
| 53        | Lo Hi                  | Reads hi frequency table entry number  | -                 |
| 58        | Write Freq             | Writes channel frequency   | 2 or 3            |
| 59        | Ch.No.                 | Sets the selected channel number (Receiver)                                      | 2                 |
| 60        | Halt                   | Stops positioner   | -                 |
| 61        | Go E                   | Directs positioner to the east   | -                 |
|           | Go W                   | Directs the positioner to the west   | 62                |
| 64        | P Status               | Reads positioner status register   | -                 |
| 65        | Read Pos               | Reads positioner counter   | -                 |
| 6C        | Goto                   | Drives positioner motor to counter value hi, low                                 | 2                 |
| 6D        | Write Pos              | Set positioner counter hi, low   | 2                 |

In the MSK 33, two different DiSEqC types have integrated. DiSEqC 1.0: With this system, DiSEqC commands can be sent but not received. DiSEqC 2.0: With this system, DiSEqC commands can be sent and received (highlighted in grey in the table). Bold commands are preferably used for Kathrein switching matrices.

# Technical Appendix

## Command overview data byte

An appropriate data byte must only be transmitted, if the command byte requires the data byte(s). You can take these from the command byte table. To find out which data byte must be transmitted to the respective command byte, please refer to the data sheets of the respective unit.

| Orbit position | Switch position H/V | Switch position LNB | Data byte | Recall |
|----------------|---------------------|---------------------|-----------|--------|
| 1              | V                   | Lo                  | F0        | 80     |
|                | V                   | Hi                  | F1        | 81     |
|                | H                   | Lo                  | F2        | 82     |
|                | H                   | Hi                  | F3        | 83     |
| 2              | V                   | Lo                  | F4        | 84     |
|                | V                   | Hi                  | F5        | 85     |
|                | H                   | Lo                  | F6        | 86     |
|                | H                   | Hi                  | F7        | 87     |
| 3              | V                   | Lo                  | F8        | 88     |
|                | V                   | Hi                  | F9        | 89     |
|                | H                   | Lo                  | FA        | 90     |
|                | H                   | Hi                  | FB        | 91     |
| 4              | V                   | Lo                  | FC        | 92     |
|                | V                   | Hi                  | FD        | 93     |
|                | H                   | Lo                  | FE        | 94     |
|                | H                   | Hi                  | FF        | 95     |

## DiSEqC commands for Kathrein matrices

These commands are stored under the recall addresses 80...95 at the factory.

### Command for Kathrein matrix 9xx-series

| Range          | POS. A (Satellite1) |             |             |             |
|----------------|---------------------|-------------|-------------|-------------|
|                | Low-band            |             | High-band   |             |
|                | Vert.               | Hor.        | Vert.       | Hor.        |
| DiSEqC-command | F0 00 38 F0         | F0 00 38 F2 | F0 00 38 F1 | F0 00 38 F3 |

| Range          | POS. B (Satellite 2) |             |             |             |
|----------------|----------------------|-------------|-------------|-------------|
|                | Low-band             |             | High-band   |             |
|                | Vert.                | Hor.        | Vert.       | Hor.        |
| DiSEqC-command | F0 00 38 F4          | F0 00 38 F6 | F0 00 38 F5 | F0 00 38 F7 |

### Command for Kathrein matrix EXR 20

| Range          | EXR 20   |          |
|----------------|----------|----------|
|                | POS. A   | POS. B   |
| DiSEqC-command | E0 00 22 | E0 00 26 |

### Command for Kathrein matrix EXR 22

| Range          | EXR 22    |          |
|----------------|-----------|----------|
|                | High-band | Low-band |
| DiSEqC-command | E0 00 24  | E0 00 20 |



# Technical Appendix

## Channel and frequency table standard L(frequency in MHz)

The table show the channel, display MSK 33 and frequency.

| VHF              |     |        | UHF              |     |        | UHF |     |        |
|------------------|-----|--------|------------------|-----|--------|-----|-----|--------|
|                  | C01 | 80.75  | 21               | C21 | 471.25 | 46  | C46 | 671.25 |
| *LB              | C02 | 55.75  | 22               | C22 | 479.25 | 47  | C47 | 679.25 |
| *LC              | C03 | 60.50  | 23               | C23 | 487.25 | 48  | C48 | 687.25 |
| *LC1             | C04 | 63.75  | 24               | C24 | 495.25 | 49  | C49 | 695.25 |
| L1               | C05 | 176.00 | 25               | C25 | 503.25 | 50  | C50 | 703.25 |
| L2               | C06 | 184.00 | 26               | C26 | 511.25 | 51  | C51 | 711.25 |
| L3               | C07 | 192.00 | 27               | C27 | 519.25 | 52  | C52 | 719.25 |
| L4               | C08 | 200.00 | 28               | C28 | 527.25 | 53  | C53 | 727.25 |
| L5               | C09 | 208.00 | 29               | C29 | 535.25 | 54  | C54 | 735.25 |
| L6               | C10 | 216.00 | 30               | C30 | 543.25 | 55  | C55 | 743.25 |
|                  | C11 | 308.75 | 31               | C31 | 551.25 | 56  | C56 | 751.25 |
|                  | C12 |        | 32               | C32 | 559.25 | 57  | C57 | 759.25 |
|                  | C13 | 861.75 | 33               | C33 | 567.25 | 58  | C58 | 767.25 |
| K <sub>1</sub> 4 | C14 | 175.25 | 34               | C34 | 575.25 | 59  | C59 | 775.25 |
| K <sub>1</sub> 5 | C15 | 183.25 | 35               | C35 | 583.25 | 60  | C60 | 783.25 |
| K <sub>1</sub> 6 | C16 | 191.25 | 36               | C36 | 591.25 | 61  | C61 | 791.25 |
| K <sub>1</sub> 7 | C17 | 199.25 | 37               | C37 | 599.25 | 62  | C62 | 799.25 |
| K <sub>1</sub> 8 | C18 | 207.25 | 38               | C38 | 607.25 | 63  | C63 | 807.25 |
| K <sub>1</sub> 9 | C19 | 215.25 | 39               | C39 | 615.25 | 64  | C64 | 815.25 |
|                  | C20 | 223.25 | 40               | C40 | 623.25 | 65  | C65 | 823.25 |
|                  |     |        | 41               | C41 | 631.25 | 66  | C66 | 831.25 |
|                  |     |        | 42               | C42 | 639.25 | 67  | C67 | 839.25 |
|                  |     |        | 43               | C43 | 647.25 | 68  | C68 | 847.25 |
|                  |     |        | 44               | C44 | 655.25 | 69  | C69 | 855.25 |
|                  |     |        | 45               | C45 | 663.25 | 70  | C70 | 863.25 |
|                  |     |        | Special channels |     |        |     |     |        |
|                  |     |        | S01              | S01 | 120.00 | S21 | S21 | 280.00 |
|                  |     |        | S02              | S02 | 128.00 | S22 | S22 | 288.00 |
|                  |     |        | S03              | S03 | 136.00 | S23 | S23 | 303.25 |
|                  |     |        | S04              | S04 | 144.00 | S24 | S24 | 315.25 |
|                  |     |        | S05              | S05 | 152.00 | S25 | S25 | 327.25 |
|                  |     |        | S06              | ?   |        | S26 | S26 | 339.25 |
|                  |     |        | S07              | S07 | 168.00 | S27 | S27 | 351.25 |
|                  |     |        | S08              | S08 | 176.00 | S28 | S29 | 363.25 |
|                  |     |        | S09              | S09 | 184.00 | S29 | S29 | 375.25 |
|                  |     |        | S10              | S10 | 192.00 | S30 | S30 | 387.25 |
|                  |     |        | S11              |     | 200.00 | S31 | S31 | 399.25 |
|                  |     |        | S12              | S12 | 208.00 | S32 | S32 | 411.25 |
|                  |     |        | S13              | S13 | 216.00 | S33 | S33 | 423.25 |
|                  |     |        | S14              | S14 | 224.00 | S34 | S34 | 435.25 |
|                  |     |        | S15              | S15 | 232.00 | S35 | S35 | 447.25 |
|                  |     |        | S16              | S16 | 240.00 | S36 | S36 | 459.25 |
|                  |     |        | S17              | S17 | 248.00 |     |     |        |
|                  |     |        | S18              | S18 | 256.00 |     |     |        |
|                  |     |        | S19              | S19 | 264.00 |     |     |        |
|                  |     |        | S20              | S20 | 272.00 |     |     |        |

# Technical Appendix

## Channel and frequency table standard D/K (frequency in MHz)

The table show the channel, display MSK 33 and frequency.

| VHF    |     |        | UHF              |     |        | UHF |     |        |
|--------|-----|--------|------------------|-----|--------|-----|-----|--------|
| R-I    | C01 | 49.75  | 21               | C21 | 471.25 | 46  | C46 | 671.25 |
| R-II   | C02 | 59.75  | 22               | C22 | 479.25 | 47  | C47 | 679.25 |
| R-III  | C03 | 77.25  | 23               | C23 | 487.25 | 48  | C48 | 687.25 |
| R-IV   | C04 | 85.25  | 24               | C24 | 495.25 | 49  | C49 | 695.25 |
| R-V    | ?   | ?      | 25               | C25 | 503.25 | 50  | C50 | 703.25 |
| R-VI   | C06 | 175.25 | 26               | C26 | 511.25 | 51  | C51 | 711.25 |
| R-VII  | C07 | 183.25 | 27               | C27 | 519.25 | 52  | C52 | 719.25 |
| R-VIII | C08 | 191.25 | 28               | C28 | 527.25 | 53  | C53 | 727.25 |
| R-IX   | C09 | 199.25 | 29               | C29 | 535.25 | 54  | C54 | 735.25 |
| R-X    | C10 | 207.25 | 30               | C30 | 543.25 | 55  | C55 | 743.25 |
| R-XI   | C11 | 215.25 | 31               | C31 | 551.25 | 56  | C56 | 751.25 |
| R-XII  | C12 | 223.25 | 32               | C32 | 559.25 | 57  | C57 | 759.25 |
|        | C13 | 50.00  | 33               | C33 | 567.25 | 58  | C58 | 767.25 |
|        | C14 | 60.00  | 34               | C34 | 575.25 | 59  | C59 | 775.25 |
|        | C15 | 70.00  | 35               | C35 | 583.25 | 60  | C60 | 783.25 |
|        | C16 | 75.00  | 36               | C36 | 591.25 | 61  | C61 | 791.25 |
|        | C17 | 80.00  | 37               | C37 | 599.25 | 62  | C62 | 799.25 |
|        | C18 | 90.00  | 38               | C38 | 607.25 | 63  | C63 | 807.25 |
|        | C19 | 175.00 | 39               | C39 | 615.25 | 64  | C64 | 815.25 |
|        | C20 | 200.00 | 40               | C40 | 623.25 | 65  | C65 | 823.25 |
|        |     |        | 41               | C41 | 631.25 | 66  | C66 | 831.25 |
|        |     |        | 42               | C42 | 639.25 | 67  | C67 | 839.25 |
|        |     |        | 43               | C43 | 647.25 | 68  | C68 | 847.25 |
|        |     |        | 44               | C44 | 655.25 | 69  | C69 | 855.25 |
|        |     |        | 45               | C45 | 663.25 | 70  | C70 | 863.25 |
|        |     |        | Special channels |     |        |     |     |        |
|        |     |        | S01              | S01 | 111.25 | S21 | S21 | 311.25 |
|        |     |        | S02              | S02 | 119.25 | S22 | S22 | 319.25 |
|        |     |        | S03              | S03 | 127.25 | S23 | S23 | 327.25 |
|        |     |        | S04              |     | 135.25 | S24 | S24 | 335.25 |
|        |     |        | S05              | S05 | 143.25 | S25 | S25 | 343.25 |
|        |     |        | S06              | S06 | 151.75 | S26 | S26 | 351.25 |
|        |     |        | S07              | S07 | 159.25 | S27 | S27 | 359.25 |
|        |     |        | S08              | S08 | 167.25 | S28 | S29 | 367.25 |
|        |     |        | S09              | S09 | 100.25 | S29 | S29 | 375.25 |
|        |     |        | S10              | S10 | 105.25 | S30 | S30 | 383.25 |
|        |     |        | S11              | S11 | 231.25 | S31 | S31 | 391.25 |
|        |     |        | S12              | S12 | 239.25 | S32 | S32 | 399.25 |
|        |     |        | S13              | S13 | 247.25 | S33 | S33 | 407.25 |
|        |     |        | S14              | S14 | 255.25 | S34 | S34 | 415.25 |
|        |     |        | S15              | S15 | 263.25 | S35 | S35 | 423.25 |
|        |     |        | S16              | S16 | 271.25 | S36 | S36 | 431.25 |
|        |     |        | S17              | S17 | 279.25 | S37 | S37 | 439.25 |
|        |     |        | S18              | S18 | 287.25 | S38 | S38 | 447.25 |
|        |     |        | S19              | S19 | 295.25 | S39 | S39 | 455.25 |
|        |     |        | S20              | S20 | 303.25 | S40 | S40 | 463.25 |

# Technical Appendix

## Channel and frequency table standard I (frequency in MHz)

The table show the channel, display MSK 33 and frequency.

| VHF |     |        | UHF              |     |        | UHF |     |        |
|-----|-----|--------|------------------|-----|--------|-----|-----|--------|
| IA  | C01 | 45.75  | 21               | C21 | 471.25 | 46  | C46 | 671.25 |
| IB  | C02 | 53.75  | 22               | C22 | 479.25 | 47  | C47 | 679.25 |
| IC  | C03 | 61.75  | 23               | C23 | 487.25 | 48  | C48 | 687.25 |
| ID  | C04 | 175.25 | 24               | C24 | 495.25 | 49  | C49 | 695.25 |
| IE  | C05 | 183.25 | 25               | C25 | 503.25 | 50  | C50 | 703.25 |
| IF  | C06 | 191.25 | 26               | C26 | 511.25 | 51  | C51 | 711.25 |
| IG  | C07 | 199.25 | 27               | C27 | 519.25 | 52  | C52 | 719.25 |
| IH  | C08 | 207.25 | 28               | C28 | 527.25 | 53  | C53 | 727.25 |
| IJ  | C09 | 215.25 | 29               | C29 | 535.25 | 54  | C54 | 735.25 |
|     | C10 | 223.25 | 30               | C30 | 543.25 | 55  | C55 | 743.25 |
|     | C11 | 231.25 | 31               | C31 | 551.25 | 56  | C56 | 751.25 |
|     | C12 | 239.25 | 32               | C32 | 559.25 | 57  | C57 | 759.25 |
|     | C13 | 247.45 | 33               | C33 | 567.25 | 58  | C58 | 767.25 |
|     | C14 | 50.00  | 34               | C34 | 575.25 | 59  | C59 | 775.25 |
|     | C15 | 60.00  | 35               | C35 | 583.25 | 60  | C60 | 783.25 |
|     | C16 | 70.00  | 36               | C36 | 591.25 | 61  | C61 | 791.25 |
|     | C17 | 75.00  | 37               | C37 | 599.25 | 62  | C62 | 799.25 |
|     | C18 | 80.00  | 38               | C38 | 607.25 | 63  | C63 | 807.25 |
|     | C19 | 90.00  | 39               | C39 | 615.25 | 64  | C64 | 815.25 |
|     | C20 | 175.00 | 40               | C40 | 623.25 | 65  | C65 | 823.25 |
|     |     |        | 41               | C41 | 631.25 | 66  | C66 | 831.25 |
|     |     |        | 42               | C42 | 639.25 | 67  | C67 | 839.25 |
|     |     |        | 43               | C43 | 647.25 | 68  | C68 | 847.25 |
|     |     |        | 44               | C44 | 655.25 | 69  | C69 | 855.25 |
|     |     |        | 45               | C45 | 663.25 | 70  | C70 | 863.25 |
|     |     |        | Special channels |     |        |     |     |        |
|     |     |        | S01              | S01 | 111.25 | S21 | S21 | 311.25 |
|     |     |        | S02              |     | 119.25 | S22 | S22 | 319.25 |
|     |     |        | S03              | S03 | 127.25 | S23 | S23 | 327.25 |
|     |     |        | S04              | S04 | 135.25 | S24 | S24 | 335.25 |
|     |     |        | S05              | S05 | 143.25 | S25 | S25 | 343.25 |
|     |     |        | S06              | S06 | 151.75 | S26 | S26 | 351.25 |
|     |     |        | S07              | S07 | 159.25 | S27 | S27 | 359.25 |
|     |     |        | S08              | S08 | 167.25 | S28 | S29 | 367.25 |
|     |     |        | S09              | S09 | 100.25 | S29 | S29 | 375.25 |
|     |     |        | S10              | S10 | 105.25 | S30 | S30 | 383.25 |
|     |     |        | S11              | S11 | 231.25 | S31 | S31 | 391.25 |
|     |     |        | S12              | S12 | 239.25 | S32 | S32 | 399.25 |
|     |     |        | S13              | S13 | 247.25 | S33 | S33 | 407.25 |
|     |     |        | S14              | S14 | 255.25 | S34 | S34 | 415.25 |
|     |     |        | S15              | S15 | 263.25 | S35 | S35 | 423.25 |
|     |     |        | S16              | S16 | 271.25 | S36 | S36 | 431.25 |
|     |     |        | S17              | S17 | 279.25 | S37 | S37 | 439.25 |
|     |     |        | S18              | S18 | 287.25 | S38 | S38 | 447.25 |
|     |     |        | S19              | S19 | 295.25 | S39 | S39 | 455.25 |
|     |     |        | S20              | S20 | 303.25 | S40 | S40 | 463.25 |



# Technical Appendix

## Channel and frequency table standard M/N (frequency in MHz)

The table show the channel, display MSK 33 and frequency.

| VHF |    |         | UHF |     |        | UHF |     |        |
|-----|----|---------|-----|-----|--------|-----|-----|--------|
|     | 01 | C72.00  | 14  | C14 | 471.25 | 47  | C47 | 669.25 |
| A02 | 02 | C55.25  | 15  | C15 | 477.25 | 48  | C48 | 675.25 |
| A03 | 03 | C61.25  | 16  | C16 | 483.25 | 49  | C49 | 681.25 |
| A04 | 04 | C67.25  | 17  | C17 | 489.25 | 50  | C50 | 687.25 |
| A05 | 05 | C77.25  | 18  | C18 | 495.25 | 51  | C51 | 693.25 |
| A06 | 06 | C83.25  | 19  | C19 | 501.25 | 52  | C52 | 699.25 |
| A07 | 07 | C175.25 | 20  | C20 | 507.25 | 53  | C53 | 705.25 |
| A08 | 08 | C181.25 | 21  | C21 | 513.25 | 54  | C54 | 711.25 |
| A09 | 09 | C187.25 | 22  | C22 | 519.25 | 55  | C55 | 717.25 |
| A10 | 10 | C193.25 | 23  | C23 | 525.25 | 56  | C56 | 723.25 |
| A11 | 11 | C199.25 | 24  | C24 | 531.25 | 57  | C57 | 729.25 |
| A12 | 12 | C205.25 | 25  | C25 | 537.25 | 58  | C58 | 735.25 |
| A13 | 13 | C211.25 | 26  | C26 | 543.25 | 59  | C59 | 741.25 |
|     |    |         | 27  | C27 | 549.25 | 60  | C60 | 747.25 |
|     |    |         | 28  | C28 | 555.25 | 61  | C61 | 753.25 |
|     |    |         | 29  | C29 | 561.25 | 62  | C62 | 759.25 |
|     |    |         | 30  | C30 | 567.25 | 63  | C63 | 765.25 |
|     |    |         | 31  | C31 | 573.25 | 64  | C64 | 771.25 |
|     |    |         | 32  | C32 | 579.25 | 65  | C65 | 777.25 |
|     |    |         | 33  | C33 | 585.25 | 66  | C66 | 783.25 |
|     |    |         | 34  | C34 | 591.25 | 67  | C67 | 789.25 |
|     |    |         | 35  | C35 | 597.25 | 68  | C68 | 795.25 |
|     |    |         | 36  | C36 | 603.25 | 69  | C69 | 801.25 |
|     |    |         | 37  | C37 | 609.25 | 70  | C70 | 807.25 |
|     |    |         | 38  | C38 | 615.25 | 71  | C71 | 813.25 |
|     |    |         | 39  | C39 | 621.25 | 72  | C72 | 819.25 |
|     |    |         | 40  | C40 | 627.25 | 73  | C73 | 825.25 |
|     |    |         | 41  | C41 | 633.25 | 74  | C74 | 831.25 |
|     |    |         | 42  | C42 | 639.25 | 75  | C75 | 837.25 |
|     |    |         | 43  | C43 | 645.25 | 76  | C76 | 843.25 |
|     |    |         | 44  | C44 | 651.25 | 77  | C77 | 849.25 |
|     |    |         | 45  | C45 | 657.25 | 78  | C78 | 855.25 |
|     |    |         | 46  | C46 | 663.25 | 79  | C79 | 861.25 |

# Technical Appendix

## Channel and frequency table standard M/N(frequency in MHz)

The table show the channel, display MSK 33 and frequency.

| Special channels |     |        | Special channels |     |        |
|------------------|-----|--------|------------------|-----|--------|
| A-5 95 959       | S01 | 91.25  | OO 51            | S43 | 385.25 |
| A 4 96           | S02 | 97.25  | PP 52            | S44 | 391.25 |
| A-3 97           | S03 | 103.25 | QQ 53            | S45 | 397.25 |
| A-2 98           | S04 | 109.25 | RR 54            | S46 | 403.25 |
| A-1 99           | S05 | 115.25 | SS 55            | S47 | 409.25 |
| A 14             | S06 | 121.25 | TT 56            | S48 | 415.25 |
| B 15             | S07 | 127.25 | UU 57            | S49 | 421.25 |
| C 16             | S08 | 133.25 | VV 58            | S50 | 427.25 |
| D 17             | S09 | 139.25 | WW 59            | S51 | 433.25 |
| E 18             | S10 | 145.25 | AAA 60           | S52 | 439.25 |
| F 19             | S11 | 151.25 | BBB 61           | S53 | 445.25 |
| G 20             | S12 | 157.25 | CCC 62           | S54 | 451.25 |
| H 21             | S13 | 163.25 | DDD 63           | S55 | 457.25 |
| I 22             | S14 | 169.25 | EEE 64           | S56 | 463.25 |
| J 23             | S15 | 217.25 | 65               | S57 | 469.25 |
| K 24             | S16 | 223.25 | 66               | S58 | 475.25 |
| L 25             | S17 | 229.25 | 67               | S59 | 481.25 |
| M 26             | S18 | 235.25 | 68               | S60 | 487.25 |
| N 27             | S19 | 241.25 | 69               | S61 | 493.25 |
| O 28             | S20 | 247.25 | 70               | S62 | 499.25 |
| P 29             | S21 | 253.25 | 71               | S63 | 505.25 |
| Q 30             | S22 | 259.25 | 72               | S64 | 511.25 |
| R 31             | S23 | 265.25 | 73               | S65 | 517.25 |
| S 32             | S24 | 271.25 | 74               | S66 | 523.25 |
| T 33             | S25 | 277.25 | 75               | S67 | 529.25 |
| U 34             | S26 | 283.25 | 76               | S68 | 535.25 |
| V 35             | S27 | 289.25 | 77               | S69 | 541.25 |
| W 36             | S28 | 295.25 | 78               | S70 | 547.25 |
| AA 37            | S29 | 301.25 | 79               | S71 | 553.25 |
| BB 38            | S30 | 307.25 | 80               | S72 | 559.25 |
| CC 39            | S31 | 313.25 | 81               | S73 | 565.25 |
| DD 40            | S32 | 319.25 | 82               | S74 | 571.25 |
| EE 41            | S33 | 325.25 | 83               | S75 | 577.25 |
| FF 42            | S34 | 331.25 | 84               | S76 | 583.25 |
| GG 43            | S35 | 337.25 | 85               | S77 | 589.25 |
| HH 44            | S36 | 343.25 | 86               | S78 | 595.25 |
| II 45            | S37 | 349.25 | 87               | S79 | 601.25 |
| JJ 46            | S38 | 355.25 | 88               | S80 | 607.25 |
| KK 47            | S39 | 361.25 | 89               | S81 | 613.25 |
| LL 48            | S40 | 367.25 | 90               | S82 | 619.25 |
| MM 49            | S41 | 373.25 | 91               | S83 | 625.25 |
| NN 50            | S42 | 379.25 | 92               | S84 | 631.25 |
|                  |     |        | 93               | S85 | 637.25 |

# Technical Data

## Technical data

### Power supply

|  |             |  |
|--|-------------|--|
| Mains operation                            |             | 100...250 V~/50...400 Hz   |
| Accumulator operation                      |             | Lead accumulator 12 VDC/3.5 Ah   |
| Power draw DCP <sub>max</sub>              |             | 50 W   |
| Power draw ACP <sub>max</sub>              |             | 62 W   |
| Dimensions                                 |             | Width 275 mm, Height 130 mm, Depth 317 mm  |
| Safety standards                           |             | CE-symbol<br>Protection class I<br>VDE EN 61010  |
| Screen                                     |             | 5,5" TFT screen 320 x 240 pixel<br>Pixel error max. ≤6 with a distance of ≥6.5 mm ∅<br>+5 °C to +45 °C |
| Temperature range                          |             | -20 °C to + 70 °C  |
| Storage and operating temperature          |             |  |
| Frequency range                            | SAT         | 920 MHz...2150 MHz   |
|  | TV          | 44.75 MHz...867.20 MHz   |
|  | DVB-T       | 178 MHz...227 MHz / 474 MHz...858 MHz  |
|  | FM          | 88 MHz...108 MHz (45.75 MHz...867.20 MHz)  |
|  | ZF          | 38.9 MHz   |
|  | RP          | 4...80 MHz return path   |
| Channel plan                               | TV          | Standard B 7 MHz<br>Standard D/G/I/K 8 MHz<br>Standard M 6 MHz   |
| Frequency setting                          | SAT         | in 0.125-MHz increments  |
|  | TV/FM       | in 50-kHz increments   |
|  | RP          | in 50-kHz increments   |
| Test error /level                          | SAT         | max. ±2 dB   |
|  | TV/FM       | max. ±2dB  |
|  | RP          | max. ±2dB  |
| Slope                                      | TV (BT/TT)  | ≤1.5 dB except S41 (461.25 MHz) ≤4 dB<br>C70 (863.25 MHz) ≤2.5 dB                                      |
| RF input                                   |             | Coaxial socket BNC 75 Ω (50 Ω Option)  |
| RF input factor                            |             | 0-60 dB in 4 dB increments   |
| Level measurement range                    | SAT/TV/FM   | 30 dBμV – 130 dBμV (DVB-T 30dBμV-130dBμV)  |
|  | IF/RP       | 70 dBμV – 130 dBμV (30 dBμV – 130 dBμV)  |
| Measurement bandwidth                      | SAT         | 8 MHz  |
|  | SAT DVB     | 8 MHz  |
|  | TV          | 1 MHz  |
|  | TV DVB      | 1 MHz  |
|  | FM          | 200 kHz  |
|  | RP          | 1 MHz  |
|  | RP DVB      | 1 MHz/200 kHz (depend. on system rate setting)   |
| Measurement detector                       | SAT         | Mean value display   |
|  | TV          | Peak value display   |
|  | FM          | Mean value display   |
|  | DVB-C/S/T   | Mean value (corrected)   |
|  | RP analogue | Peak value display   |
|  | RP digital  | Mean value display (corrected)   |
| Return loss                                | TV          | ≥10dB (15 dB option 75Ω); (15 dB option 50Ω)   |
|  | SAT         | ≥8dB   |
| Audio IF bandwidth                         | SAT         | 130 kHz /280 kHz   |
|  | TV          | 200 kHz  |
|  | FM          | 200 kHz  |
| Audio de-emphasis                          | SAT         | 50 μs /DNR 75 μs / J17   |
|  | TV/FM       | 50 μs  |
| Audio carrier measurement and demodulation | SAT         | FM-audio processing<br>4.99...9.01 MHz in 10 kHz increments  |

# Technical Data

|                               |                     |  |                            |
|-------------------------------|---------------------|--|----------------------------|
|                               | TV                  | Standard B/G   | TT1=5.5 MHz, TT2=5.74 MHz  |
|                               |                     | Standard D/K   | TT1=6.5 MHz, TT2=6.26 MHz  |
|                               |                     | Standard I   | TT1=6.0 MHz                |
|                               |                     | Standard M/M <sub>jap.</sub>   | TT1=4.5 MHz, TT2=4.72 MHz  |
|                               |                     | Standard L   | AM 6.5 MHz, Nicam=5.85 MHz |
|                               |                     | Standard B/G   | Nicam=5.85 MHz             |
|                               |                     | Standard I   | Nicam=6.552 MHz            |
|                               | FM                  | FM audio processing  |                            |
|                               |                     | 45 MHz...867 MHz   |                            |
| Nicam –audio - bit error rate | TV                  | 0 – 1.5 x 10 <sup>-2</sup>   |                            |
| Video output (Scart)          | SAT                 | 1 V <sub>pp</sub> / 75 Ω ≤±3 dB  |                            |
|                               | TV                  | 1 V <sub>pp</sub> / 75 Ω ≤±1 dB  |                            |
| Video output (BNC/option)     | SAT                 | 1 V <sub>pp</sub> / 75 Ω ≤±3 dB  |                            |
|                               | TV                  | 1 V <sub>pp</sub> / 75 Ω ≤±1 dB  |                            |
| LNB supply voltage            | SAT                 | 0.10 V...20 V, max. 500 mA   |                            |
| LNB control                   | SAT                 | 22 kHz, DiSEqC, Simple DiSEqC, (Tone Burst), V-SEC, UFO <sub>μ</sub> -DiSEqC |                            |
| SAT analogue measurements     | LNB current         | 0...500 mA   | ±10 mA                     |
|                               | LNB- voltage        | 0...30 V   | ±100 mV                    |
|                               | C/N                 | 0...35 dB  | ±2 dB                      |
|                               | S/N                 | 35...50 dB   | ±2 dB (weighted)           |
|                               | Cross-polarisation  | 0...30 dB  | ±2 dB                      |
| TV analogue measurements      | Remote feed current | 0...500 mA   | ±10 mA                     |
|                               |                     | 0...30 V   | ±100 mV                    |
|                               | Remote feed volt.   | 35...47 dB   | ±2 dB (weighted)           |
|                               | S/N                 |  |                            |
| DVB-S measurements            | SNR                 | to 12 dB   |                            |
| QPSK                          | BER                 | 1x10 <sup>-2</sup> ...1x10 <sup>-8</sup> (0)                                 |                            |
| DVB-C measurements            | MER                 | to 32 dB at QAM64  |                            |
| QAM64, QAM128, QAM256         | BER                 | 1x10 <sup>-2</sup> ...1x10 <sup>-8</sup> (0) at QAM64                        |                            |
|                               |                     | (BER better 1x10 <sup>-8</sup> for level > 57 dB <sub>μ</sub> V)             |                            |
| DVB-T measurements            | SNR                 | to 32 dB   |                            |
| 2k / 8k mode                  | BER                 | 5x10 <sup>-2</sup> ...1x10 <sup>-8</sup> (0)                                 |                            |
| Weight                        |                     | ca. 7 kg   |                            |

# Technical Data

## Scope of delivery

- 1 Mains cable
- 1 Measurement cable- BNC-connector - BNC- connector -
- 1 Adapter - BNC- socket - F-socket
- 1 Adapter - BNC- socket - F- connector -
- 1 Adapter - BNC- socket - IEC connector -
- 1 Adapter - BNC- socket - IEC socket
- 1 Operating manual

## Accessories

|                             |                    |
|-----------------------------|--------------------|
| Leather bag                 | Order no.: 208 589 |
| Measurement software MZS 33 | Order no.: 208 590 |
| Anti-dazzle device          | Order no.:         |
| MVG10 signal generator      | Order no.:         |

## Assignment of the SCART socket

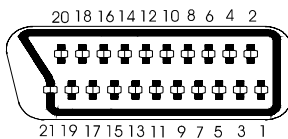

| Connection | Signal                | Note                                    |
|------------|-----------------------|---|
| 1          | Audio right output    |   |
| 2          | Audio left input      |   |
| 3          | Audio left output     |   |
| 4          | Audio earth           |   |
| 5          | Blue earth            |   |
| 6          | Audio left input      |   |
| 7          | Blue signal           |   |
| 8          | Switching voltage     |   |
| 9          | Green earth           |   |
| 10         | Data signal           |   |
| 11         | Green signal          |   |
| 12         | Data signal           |   |
| 13         | Red earth             |   |
| 14         | Data earth            |   |
| 15         | Red earth             |   |
| 16         | Blanking signal       |   |
| 17         | Video earth           |   |
| 18         | Blanking signal earth |   |
| 19         | Video output          | Also basic output for decoder operation |
| 20         | Video input           | Also basic output for decoder operation |

# Technical Data

## Assignment of RS232 socket

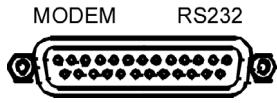

| Connection | Signal | Note |
|------------|--------|------|
| 1          |        |      |
| 2          | TXD    |      |
| 3          | RXD    |      |
| 4          | RTS    |      |
| 5          | CTS    |      |
| 6          | DSR    |      |
| 7          | S-GND  |      |
| 8          | DCD    |      |
| 9          |        |      |
| 10         |        |      |
| 11         |        |      |
| 12         |        |      |
| 13         |        |      |
| 14         |        |      |
| 15         |        |      |
| 16         |        |      |
| 17         |        |      |
| 18         |        |      |
| 19         |        |      |
| 20         | DTR    |      |
| 21         |        |      |
| 22         |        |      |
| 23         |        |      |
| 24         |        |      |
| 25         |        |      |

# Technical Data

## Assignment of socket TS PARALLEL (optional)

TS PARALLEL



| Connection | Signal                               | Abbreviation       |
|------------|--------------------------------------|--------------------|
| 1          | Clock for data item                  | CLOCK A            |
| 2          | Earth                                | GND                |
| 3          | Data bit 7 (high-value data bit)     | DATA BIT 7 A (MSB) |
| 4          | Data bit 6                           | DATA BIT 6 A       |
| 5          | Data bit 5                           | DATA BIT 5 A       |
| 6          | Data bit 4                           | DATA BIT 4 A       |
| 7          | Data bit 3                           | DATA BIT 3 A       |
| 8          | Data bit 2                           | DATA BIT 2 A       |
| 9          | Data bit 1                           | DATA BIT 1 A       |
| 10         | Data bit 0 (lowest-value bit)        | DATA BIT 0 A (LSB) |
| 11         | Data item valid                      | DVALID A           |
| 12         | Package sync                         | PSYNC A            |
| 13         | Earth                                | GND                |
| 14         | Clock for data item inverted         | CLÖCK B            |
| 15         | Earth                                | GND                |
| 16         | Data bit 7 inverted (high-value bit) | DATA BIT 7 B (MSB) |
| 17         | Data bit 6 inverted                  | DATA BIT 6 B       |
| 18         | Data bit 5 inverted                  | DATA BIT 5 B       |
| 19         | Data bit 4 inverted                  | DATA BIT 4 B       |
| 20         | Data bit 3 inverted                  | DATA BIT 3 B       |
| 21         | Data bit 2 inverted                  | DATA BIT 2 B       |
| 22         | Data bit 1 inverted                  | DATA BIT 1 B       |
| 23         | Data bit 0 inverted                  | DATA BIT 0 B       |
| 24         | Data item valid inverted             | DVALID B           |
| 25         | Package sync inverted                | PSYNC B            |

# Technical Data

## Unit variants

### MSK 33/G

Integrated graphic card  
Spectrum analyser  
S/N measurement (weighted)  
Digital video-, audio- and DiSEqC- oscilloscope

### MSK 33/Q

Integrated graphic card and digital card (DVB-C-S card)  
Coloured representation of the constellation analysis for QAM and QPSK signals  
Measurement of bit error rate for QAM and QPSK signals  
Display of modulation error rate (MER) for QAM  
Display of signal-to-noise ration SNR for QPSK

### MSK 33/M

Integrated graphic card and digital card (DVB-C-S card)  
MPEG demodulator

### MSK 33/QR, MSK 33/MR with return path card

All functions of the Q and M version, however additionally equipped with the following functions: v  
Return path measurement in the range from 4.0...80 MHz  
Level measurement from 30...130 dB $\mu$ V

### MSK 33/TQ

Like MSK33/Q additional DVB-T

### MSK 33/TM

like MSK33TQ + MPEG decoder

## Options

External 12 V DC supply current  
BNC video output  
TS-PARALLEL-LVDS interface  
Pre-echo software for DVB-T  
MZS33 cable measurement software  
Cable pre-amplifier with FM suppression 109...870 MHz



# Downloading New MSK33 Operating Software

## General notes:

Observe the bold lines. The non-bold notes can only help you solve a problem in cases of error. <RET> means to trigger the command with RETURN on the terminal programme.

1. **Copy the file „MSK33.BXX“ (XX stands for the version number) from the diskette into an easily found directory of your hard disk.**
2. **Connect the MSK33 with the PC via a zero modem cable (see respective section). Set the baud rate to 19200 baud in the MODEM menu (SETTING / MODEM). Note down the PIN (if no entry is available, PIN1 is <RET>).**  
If problems occur when using a 9-pin serial interface, the hardware handshake (r/cst) can be set to OF in the MODEM menu.
3. **Switch off the MSK33, and press down any number key on the MSK 33. Start a terminal programme (we recommend Term95 in DOS mode) on the PC => MSK33 switches on.**  
For switched of hardware handshake, the MSK 33 must be switched on by hand.  
Note: When using the terminal programme, Hyperterminal, under Windows95, we recommend to use the fonts TERMINAL STANDARD 14 and OEM/DOS. Set emulation to automatic recognition or ANSI.
4. **the MSK 33 answers now with the bootloader „MSKUL>„. Enter in PIN1 and confirm the entry with <RET> (Standard PIN1 is-MSK-33-).**  
For switched off handshake, the MSK 33 first answers after entry of <RET>. If the MSK 33 answer with „MSK 33>„, instead of „MSKUL>„, it must have been changed in the upload operating with the command, *UPL<RET>*.  
Note: With the command, *LAN<RET>*, you can change the language.
5. **With the command *UNL<RET>*, the FLASH is released for programming. Afterwards switch the MSK 33 to reception with the command, *BIN<RET>*.**  
If the message is given from the MSK 33, that the access is refused, you may have tried to log-in with PIN2 or PIN3. In this case, start over with step 1.
6. **Now, start the upload of the file „MSK33.BIN“ on the terminal programme. This occurs in the XMODEM mode (at 19200 baud ca. 3 minutes).**  
ATTENTION: Of the upload is not started within a certain period of time, the MSK 33 locks up. In this case, you must start new from step 5 (command UNL, BIN).
7. **After the upload, the uninterrupted transmission is confirmed by the MSK 33.**  
In the RAW-mode, the message is given after the successful download, that 232144 characters were downloaded.
8. **Ext the terminal programme, switch off the MSK 33, switch on the MSK 33 on again without terminal programme and set fact.setup in the menu, SETTING / SYSTEM.**



## Free Manuals Download Website

<http://myh66.com>

<http://usermanuals.us>

<http://www.somanuals.com>

<http://www.4manuals.cc>

<http://www.manual-lib.com>

<http://www.404manual.com>

<http://www.luxmanual.com>

<http://aubethermostatmanual.com>

Golf course search by state

<http://golfingnear.com>

Email search by domain

<http://emailbydomain.com>

Auto manuals search

<http://auto.somanuals.com>

TV manuals search

<http://tv.somanuals.com>