

ASSEMBLY GUIDE

455 INCH² 3-BURNER & 545 INCH² 3-BURNER

⚠ DANGER

If you smell gas:

1. Shut off gas to the appliance.
2. Extinguish any open flames.
3. Open lid.
4. If odor continues, keep away from the appliance and immediately call your gas supplier or your fire department.

Leaking gas may cause a fire or explosion which can cause serious bodily injury or death, or damage to property.

⚠ WARNING

1. Do not store or use gasoline or other flammable vapors and liquids in the vicinity of this or any other appliance.
2. An LP cylinder not connected for use shall not be stored in the vicinity of this or any other appliance.

⚠ WARNING

Follow all leak-check procedures carefully in this manual prior to barbecue operation. Do this even if the barbecue was dealer-assembled.

NOTICE TO INSTALLER

These instructions must be left with the owner and the owner should keep them for future use.

THIS GAS APPLIANCE IS DESIGNED FOR OUTDOOR USE ONLY.

⚠ WARNING

Do not try to light this appliance without reading the "Lighting" Instructions section of this manual.

Customer Service: 1-800-382-2637

NOTE: Standard LP, Natural Gas and System LP are designed for use with a Ducane® portable cart.

SAVE THESE INSTRUCTIONS FOR FUTURE REFERENCE

DUCAINE®



Important

This grill head is designed to be mounted only on a Ducane® base cabinet kit. DO NOT attempt to mount on any other type of base cabinet or in any other manner.

Read all instructions before proceeding with any assembly. For an assembly view and verification of parts, see the parts list and expanded view of pages 13-15.

Installation

NOTE: Your model may differ from those in the assembly photos.

⚠ CAUTION: Although we make every effort to ensure that the assembly process is as easy and as safe as possible, it is inherent with fabricated steel parts that corners and edges can cause cuts if improperly handled during assembly procedures. Be careful while handling any parts during assembly. **IT IS STRONGLY RECOMMENDED THAT HANDS BE PROTECTED WITH A PAIR OF WORK GLOVES.**

⚠ WARNING: Care must be taken to ensure that this grill is assembled according to these instructions. Failure to assemble the grill properly could create a fire hazard or cause burns or other bodily harm.

ASSEMBLY

1. Assemble selected base cabinet kit before proceeding with these instructions.
2. Open the hood and remove the bubble wrapped side shelf package(s), Sear Grid® package, and accessory package.



2.

-
3. With the hood open, remove the hairpin clips from the hinge clevis pins (a). Close the hood and slide clevis pins from the hood hinges (b). Lift the hood from the burner box and place it on a nonabrasive surface.

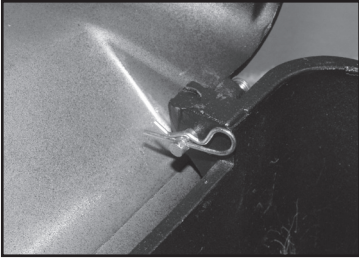
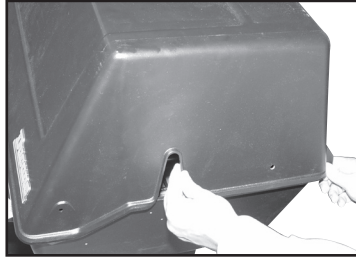
**3. (a)****3. (b)**

4. Using the hex head screws and split lock-washers from the hardware bag, attach the two hood knobs to the outside of the grill hood in the location shown. Tighten screws from the inside rather than turning the knob, to avoid scratching paint.

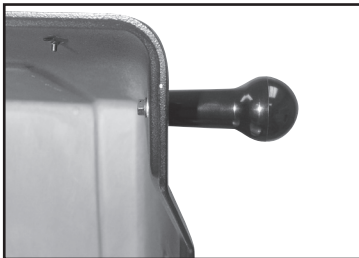
**4.**

5. Remove the Rotis-A-Grate® and the La-Va-Grate® from the burner box and position the box on the previously assembled base cabinet kit.

**5.**

-
6. Attach the burner box to the base cabinet using the four (4) 1/4x20x1" pointed screws and the four (4) 1/4" teflon washers from the base cabinet kit (a). The screws with the washers directly underneath go through the four holes in the bottom of the burner box and engage in the caged nuts in the top of the base cabinet (b). Engage all 4 screws before tightening any of the four (c). In order to get the screws in the mounting holes of some grill models, it may be necessary to carefully rotate the burners out of the way of the holes. Unscrew the burner locking screw to release the burner.

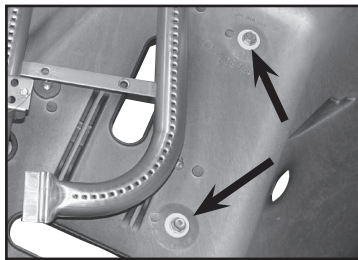

6. (a)

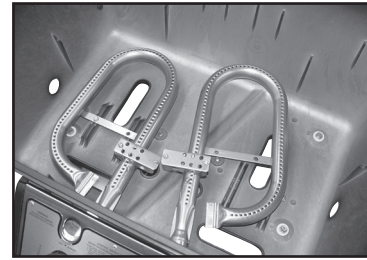

6. (b)

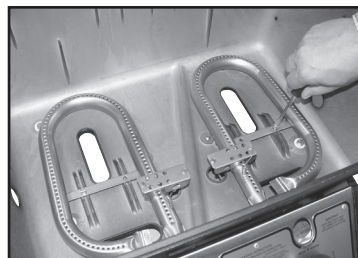

6. (c)

⚠ CAUTION: The screws used to attach the grill burner box to the base cabinet must be tightened securely but not overly tight. The Teflon washers used with these screws are very slippery and could lead to over-tightening these screws. Care should be taken to avoid compressing the washer or cracking the burner box.

⚠ CAUTION: BE CAREFUL NOT TO PULL THE BURNERS OFF THE ORIFICES OR TO DISCONNECT THE IGNITION WIRES.

-
7. Before retightening the burner locking screw (a), (b), be sure the burners are correctly engaged over their respective orifices. This can be done by removing the control box or by viewing the burner/orifice engagement from beneath the control box (c).

Burner Locking Screws

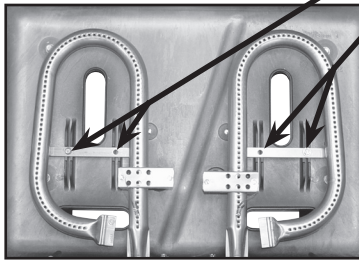

7. (a)

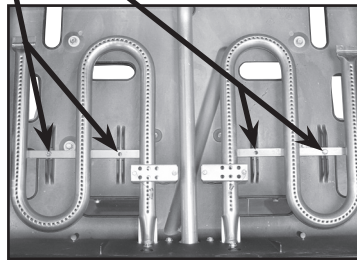

7. (b)

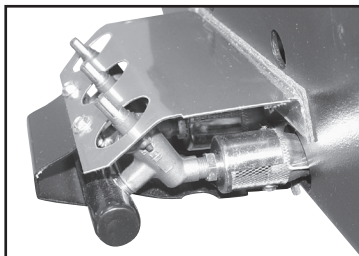

7. (c)

Important

When connecting or replacing any gas pipe fittings, all joints must be sealed with a joint compound (pipe dope) that is resistant to the action of (LP) gases.

⚠ WARNING: FAILURE TO CHECK PROPER BURNER ORIFICE ENGAGEMENTS COULD LEAD TO A HAZARDOUS CONDITION AND BODILY HARM.

-
8. FOR NATURAL AND SYSTEM LP GRILLS. Install the Natural Gas (or System LP) regulator/hose assembly on to the grills manifold supply pipe. To make the connection, pull back the outer sleeve of the socket connector, (at the end of the regulator/hose assembly), and insert all the way the male plug connection, (on the grills manifold), and then release the outer sleeve of the socket connector. This will produce a gas joint. After making gas connections, check all joints for leaks using soapy water and a brush. See Owner's Guide for more on Natural Gas (or System LP) installation.

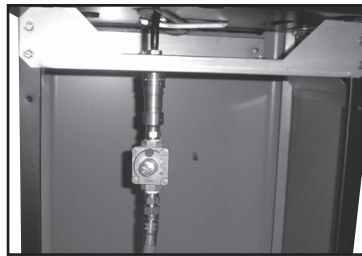

8.

After making gas connections, check all joints for leaks using soapy water and a brush.

⚠ WARNING: NEVER USE AN OPEN FLAME TO TEST FOR GAS LEAKS.

9. Assemble the side shelf frame(s) using four (4) #8 x 1 1/2 Phillip's flat head screws (a-c). Depending whether your model has one or two side shelves, attach the side shelf to either or both sides of the burner box, using four (4) 1/4 x 1 1/4" black screws, 1/4-20 nuts, and stainless steel shelf support washers (oval, with two holes). The washers should go on the inside of the burner box with the raised rib side facing away from the surface of the burner box (d). The nuts go on the inside of the burner box. Tighten all four nuts securely (e).

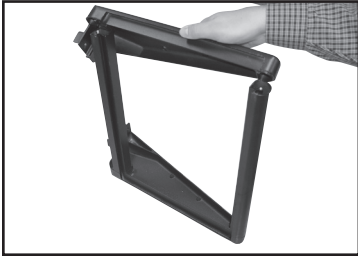

9. (a)



9. (b)



9. (c)

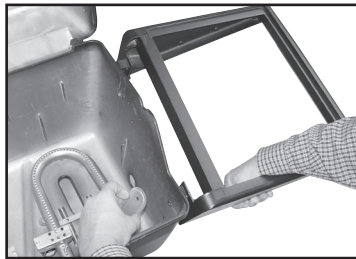

9. (d)



9. (e)

**⚠ WARNING: FAILURE TO INSTALL THE SIDE SHELF FRAME PROPERLY
COULD CAUSE THE SHELF TO LOOSEN AND FALL, CAUSING BODILY HARM.**

Side-Order Cooker® installation. If your grill does not have a Side-Order Cooker® go to step 16.

10. Remove Side-Order Cooker® packaging and remove contents.



10.

11. Facing the front of the barbecue hold the front of the Side-Order Cooker® (control knobs in front) towards you.

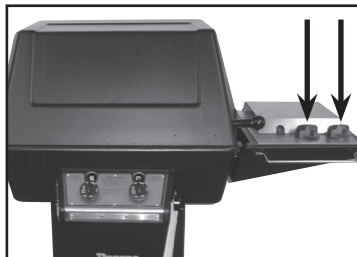

11.

12. Slide the left side flange into the shelf opening, towards the burner box, and then push the right side of the Side-Order Cooker® down into place. This action engages the two spring locks on the right side of the Side-Order Cooker®.



12.



12.

Important

Do this before attaching clip to side table.

13. To install the provided hose retention clip:

- a. Push the female quick disconnect through the retention clip.

NOTE: The orientation of the clip hole. This will be a tight fit, but it is needed to best secure the hose.

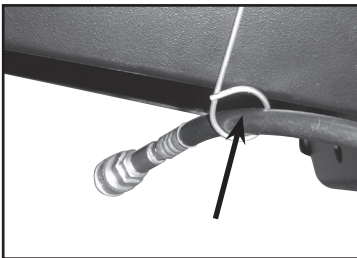

13a.

- b. Now attach the hose retention clip to the side table using the screw provided.

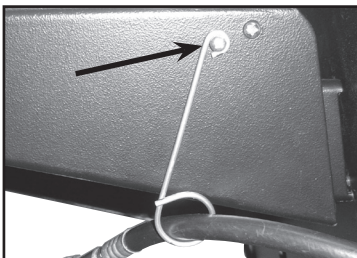

13b.

⚠ WARNING: FAILURE TO HAVE THE HOSE IN THE HOSE RETENTION CLIP MAY RESULT IN AN EXPLOSIVE FLAME-UP, WHICH CAN CAUSE SERIOUS BODILY INJURY OR DEATH.

14. To connect the gas line:

- a. Pull back collar on the quick disconnect at the end of the gas hose.

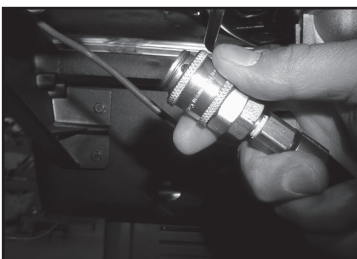

14a.

b,c. Push quick disconnect over plug coming down from Side-Order Cooker® and slide collar forward locking it into place.

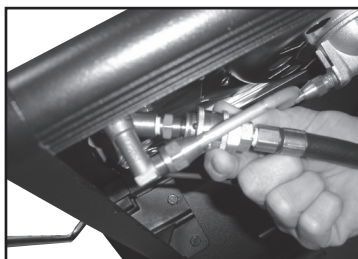

14b.

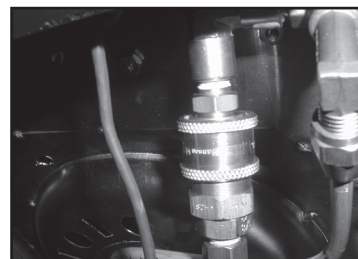

14c.

15. Remove any white protective coating from the stainless steel surfaces of the Side-Order Cooker®.
16. Replace the Rotis-A-Grate® at the rear of the burner box by lowering it over the Rotis burner, and hooking the supports on the back of the Rotis-A-Grate® over the rear edge of the burner box. Reinstall the La-Va-Grate® into the burner box by first placing the front edge of the La-Va-Grate® on the lower set of supports on the front of the burner box. Holding the flange (with the “arrow” shaped cut-out) on the rear of the La-Va-Grate®, rotate the rear edge down so that it rest on the lower “shelf” of the Rotis-A-Grate®. The “arrow” on the rear flange should be pointing up.)

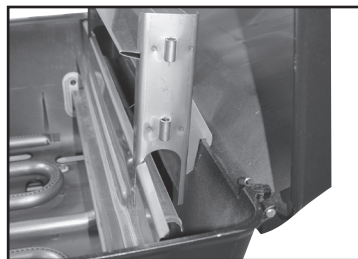

16.

17. Carefully put the hood back on the burner box and refasten with the clevis pins and hairpin clips.

18. Place the briquettes in a pattern filling the entire La-Va-Grate[®]. Spacing should be 3/8" - 1/2" between briquettes.

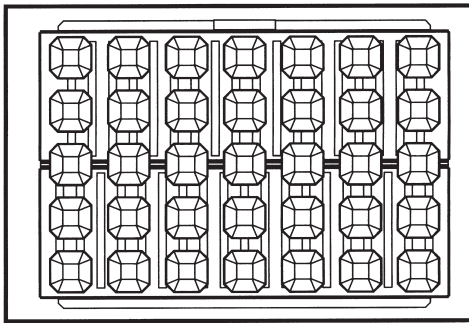

18a.
455 Inch² 3-Burner

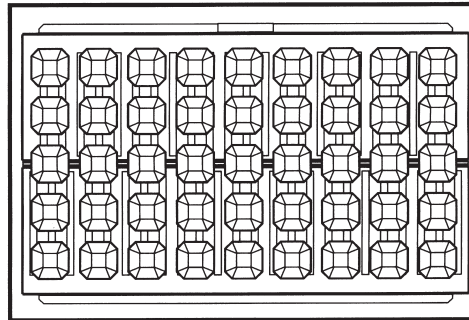

18b.
545 Inch² 3-Burner

19. Attach the Rotis motor mounting bracket to the left side of the burner box, using the three black #10 truss head screws and acorn nuts. The bracket goes inside the firebox, with the "U" shaped motor mount facing to the outside of the grill. The acorn nuts go to the inside of the burner box. Tighten the fasteners finger tight, then insure that the hood will close without hitting the motor mount. Reposition the mount as necessary to clear the hood, then tighten all three fasteners securely.

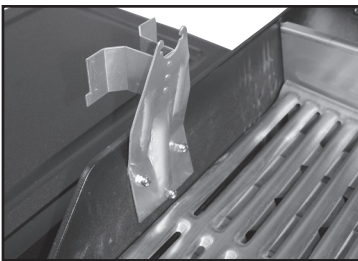

19.

20. Carefully place Sear Grid[®](s) onto the upper set of supports on the front of the burner box and the upper shelf of the Rotis-A-Grate[®] at the rear.

-
21. Assemble the meat hooks and handle to the spit rods as shown. Open the hood, slide rotis motor over the motor mount and insert the spit rod. Refer to the Owner's Manual and the Cookbook for additional information on using the rotis.



21.

⚠ CAUTION: The rotis motor must be stored indoors when not in use. DO NOT leave it mounted to the grill.

22. The regulator assembly shipped with the grill head must be used.
23. Refer to the Owner's Manual for use of the Side-Order Cooker®.
24. Refer to the Owner's Manual for proper LP tank handling procedures.
25. Refer to the Owner's Manual for the proper use and care of your gas grill.
26. For natural and for system LP grills, refer to Owner's Manual for proper procedures for connecting to the gas supply.

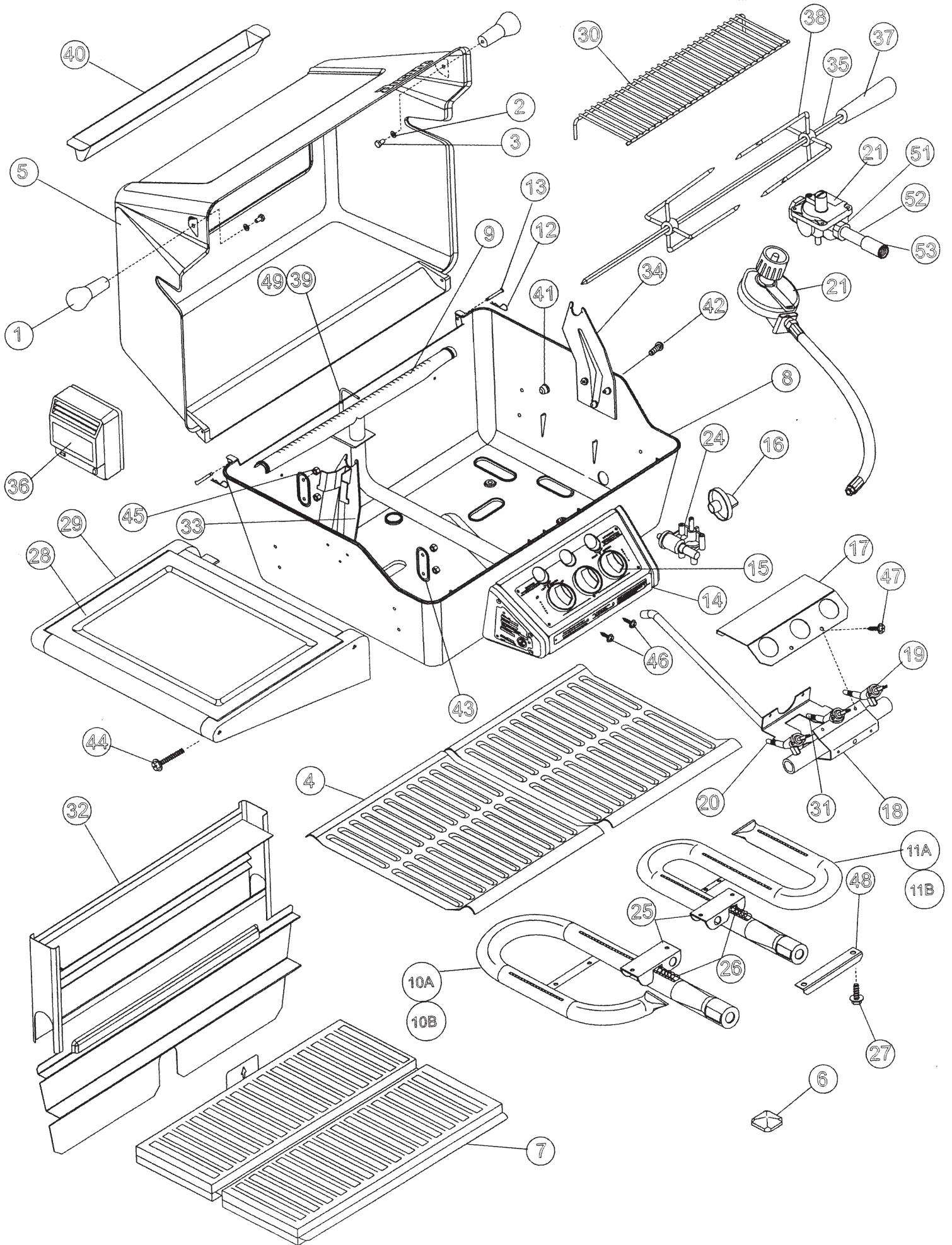

| Gas Grill Parts List | | | | | |
|--|--|-----------------------------------|------|-----------------------------------|------|
| 455 Inch² 3-Burner & 545 Inch² 3-Burner | | | | | |
| | | Model Grill | | | |
| | | 455 INCH ² 3-BURNER | | 545 INCH ² 3-BURNER | |
| Key | Part Description | Part Number | Qty. | Part Number | Qty. |
| 1 | Hood Knob | G1125350 | 2 | G1125350 | 2 |
| 2 | Lockwasher | B1008919 | 2 | B1008919 | 2 |
| 3 | 1/4-20 x 1/2 Hex Head Screw | T1009088 | 2 | T1009088 | 2 |
| 4 | Sear Grid® Set (2 Pieces Per Set) | 20172301 | 1 | 20172302 | 1 |
| 5 | Hood with Nameplate | 20174203 | 1 | 20174204 | 1 |
| 6 | Briquettes | 20172201 | 1 | 20172202 | 1 |
| 7 | La-Va-Grate® | 21072501 | 1 | 21072503 | 1 |
| 8 | Burner Box Sub-Assembly | 20116811 | 1 | 20116812 | 1 |
| 9 | Burner, Rotis-A-Grate® | 20337403 | 1 | 20337404 | 1 |
| 10a | Burner, Right Hand "P" Style (455 Inch ² 3-Burner Only) Includes 25 & 26 | 20177203 | 1 | | - |
| 10b | Burner, Left Hand "P" Style (455 Inch ² 3-Burner Only) Includes 25 & 26 | 20177204 | 1 | | - |
| 11a | Burner, Right Hand "S" Style (545 Inch ² 3-Burner Only) Includes 25 & 26 | | - | 20524704 | 1 |
| 11b | Burner, Left Hand "S" Style (545 Inch ² 3-Burner Only) Includes 25 & 26 | | - | 20524703 | 1 |
| 12 | Hair Pin Clip | G1026609 | 2 | G1026609 | 2 |
| 13 | Clevis Pin | 20175601 | 2 | 20175601 | 2 |
| 14 | Control Box | 20174801 | 1 | 20174801 | 1 |
| 15 | Control Knob | 20173203 | 3 | 20173203 | 3 |
| 16 | Igniter Knob | 20182601 | 1 | 20182601 | 1 |
| 17 | Manifold Support, Upper w/Gasket | 20174901 | 1 | 20174901 | 1 |
| 18 | Manifold Assembly w/Gasket | 20175102 | 1 | 20175201 | 1 |
| 19 | Gas Valve-Natural Gas | 20175402 | 3 | 20175402 | 3 |
| 19 | Gas Valve-LP & System LP | 20175401 | 3 | 20175401 | 3 |
| 20 | Gas Orifice, Main Burner-Natural Gas | G1031102 | 2 | G1031353 | 2 |
| 20 | Gas Orifice, Main Burner-LP & System LP | G1026743 | 2 | G1031095 | 2 |
| 21 | LP Regulator w/Type I Connector and Hose | 20104302 | 1 | 20104302 | 1 |
| 21 | Natural Gas Regulator | G1827628 | 1 | G1827628 | 1 |
| 21 | System LP Regulator | G1827584 | 1 | G1827584 | 1 |
| 23 | Burner Locking Screw #10 x 1/2 Hex Head (SS) (Not Shown) | 20525201 | 2 | 20525201 | 2 |
| 24 | Rotary Igniter | 20182501 | 1 | 20182501 | 1 |

| Gas Grill Parts List | | | | | |
|--|--|-----------------------------------|-------|-----------------------------------|-------|
| 455 Inch² 3-Burner & 545 Inch² 3-Burner | | | | | |
| | | Model Grill | | | |
| | | 455 INCH ² 3-BURNER | | 545 INCH ² 3-BURNER | |
| Key | Part Description | Part Number | Qty. | Part Number | Qty. |
| 25 | Electrode & Collector Box Assembly (Includes A-D Below) | G4313758 | 2 | G4313758 | 2 |
| A | Main Burner Electrode | G1129990 | 1 | G1129990 | 1 |
| B | #8 x 3/8 Hex Washer Head Screw (SS) | 20187001 | 3 | 20187001 | 3 |
| C | Collector Box | G4163670 | 1 | G4163670 | 1 |
| D | Collector Boxstrap | G4163698 | 1 | G4163698 | 1 |
| 26 | Glow Wire | G4313301 | 2 | G4313301 | 2 |
| 27 | 5/16-18 Self Tapping Screw | G1031406 | 2 | G1031406 | 2 |
| 28 | Side Shelf | 20171601 | 2 | 20171601 | 2 |
| 29 | Side Shelf Frame | 20171701 | 2 | 20171701 | 2 |
| 30 | Cooking Shelf | G4313794 | 1 | G4313794 | 1 |
| 31 | Gas Orifice, Rotis Burner-Natural Gas | G1031102 | 1 | G1031102 | 1 |
| 31 | Gas Orifice, Rotis Burner-LP & System LP | G1026743 | 1 | G1026743 | 1 |
| 32 | Rotis-A-Grate® | 20118502 | 1 | 20118602 | 1 |
| 33 | Left Hand Spit Rod Support | G4260574 | 1 | G1260574 | 1 |
| 34 | Right Hand Spit Rod Support | G4260583 | 1 | G4260583 | 1 |
| 35 | Spit Rod | 20176201 | 1 | 20176202 | 1 |
| 36 | Spit Motor | G0627006 | 1 | G0627006 | 1 |
| 37 | Spit Rod Handle | G1129418 | 1 | G1129418 | 1 |
| 38 | Meat Hook Set (2 Per Set) | G4313696 | 1 | G4313696 | 1 |
| 39 | Rotis-A-Grate® Electrode | G1130004 | 1 | G1130004 | 1 |
| 40 | Smoke-It Tray® | G4309147 | 1 | G4309147 | 1 |
| 41 | #10 Acorn Nut | G1026547 | 8 | G1026547 | 8 |
| 42 | #10 Truss Head Screw | G1026538 | 8 | G1026538 | 8 |
| 43 | Shelf Support Backing Plate | 20176401 | 4 | 20176401 | 4 |
| 44 | 1/4-20 x 1 1/4 Screw, Black | B1015956 | 8 | B1015956 | 8 |
| 45 | 1/4-20 Hex Nut | B1015965 | 8 | B1015965 | 8 |
| 46 | #10 x 1/2 Hex Washer Head Screw (SS) | G1026305 | 2 | G1026305 | 2 |
| 47 | #10 x 5/8 Hex Washer Head Screw | B1008062 | 6 | B1008062 | 6 |
| 48 | Angle Supply Line Support | 20176501 | 1 | 20176501 | 1 |
| 49 | Electrode Bracket Screw | B1008704 | 1 | B1008704 | 1 |
| 50 | Shelf Assy. Screw (#8 x 1 1/2) (Not Shown) | 20103903 | 4 (8) | 20103903 | 4 (8) |
| 51 | 1/8" x 3/8" NPT Bushing-Natural Gas and System LP | G1026789 | 1 | G1026789 | 1 |
| 52 | 1/8" x 1 1/2" Pipe Nipple-Natural Gas and System LP | G1031380 | 1 | G1031380 | 1 |
| 53 | 1/8" NPT Pipe Coupling-Natural Gas and System LP | G1031166 | 1 | G1031166 | 1 |
| 54 | Rotis Pan (Not Shown) | G4309129 | 1 | G4309129 | 1 |

© 2004 Ducane Products Co., 1656 Fuldner Road, Barnwell, South Carolina 29812. DUCANE is a registered trademark of Weber-Stephen Products Co. Used with permission. This product may be covered under various patents throughout the world.

20211810 01/24/05

Free Manuals Download Website

<http://myh66.com>

<http://usermanuals.us>

<http://www.somanuals.com>

<http://www.4manuals.cc>

<http://www.manual-lib.com>

<http://www.404manual.com>

<http://www.luxmanual.com>

<http://aubethermostatmanual.com>

Golf course search by state

<http://golfingnear.com>

Email search by domain

<http://emailbydomain.com>

Auto manuals search

<http://auto.somanuals.com>

TV manuals search

<http://tv.somanuals.com>