

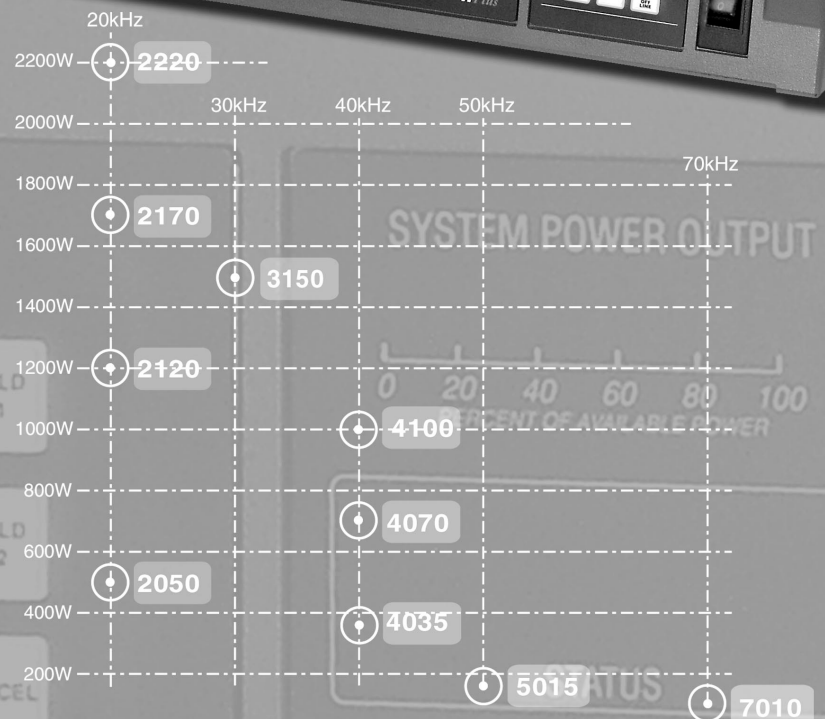

Intelligent Assembly Solutions



04
05
06
07
08
09
10
11
12
13
14
15
16
17
18
19
20
21
22
23
24
25



DPC™ II Plus & EZ Welder™

User's Manual

Dukane Part No. 403-566-01

Dukane Corporation • Ultrasonics Division • 2900 Dukane Drive • St. Charles, Illinois 60174 USA • TEL +1-630-797-4900 • FAX +1-630-797-4949

ISO 9001:2000 Dukane products are manufactured in ISO registered facilities



www.dukcorp.com/us

DPC II Plus & EZ Welder Manual Revision History

Revision Number	Revision History	Date
-00	<p>Add information for EZ-Series Generator to DPC II Plus Manual.</p> <p>Added EZ Welder™ Key Features to Section 1.</p> <p>Table 3—1 references new DPC II Plus/EZ Welder manual.</p> <p>Figure 4-1B shows EZ Generator w/o <i>Hot Key</i> for P2.</p> <p>Figure 4-8B added to show current software revision for EZ Generator. Figure 4-8A shows DPC II Plus version.</p> <p>Figure 5-1 notes Multi-Probe modules are for DPC II Plus only.</p> <p>Added note that photo on page 49 does not apply to EZ system.</p> <p>Added note to Figure 7-30 that P2 branch is for DPC II Plus systems only. EZ Series are single pressure.</p> <p>Updated Dukane's telephone numbers on pages 143-144.</p> <p>Added Table 15—II for EZ Generator Part Number.</p>	2003-Sept-25
-01	<p>Modify Table 5—V on page 48 (Pin 9 is +22V DC)</p> <p>Clarify AFTERBURST option bypass on page 73 and 80.</p> <p>Emergency Stop Switch Interface Diagram on page 25</p> <p>New consolidated warranty.</p>	2004-Dec-07

Dukane Corporation • DUKANE • Ultrasonics Division

This page intentionally left blank

TABLE OF CONTENTS

Section 1 – Introduction	1
Before Operating	3
Read The Manual First	3
Caution and Warnings.....	3
Drawings Labels	3
Manual Organization.....	4
DPC–II Plus Overview.....	6
EZ Welder Overview.....	6
Key DPC–II Plus Features	7
Key EZ Welder Features	8
Section 2 – Safety Tips	9
Health & Safety Tips	11
Plastics Health Notice	12
Electrical Grounding Safety	12
RFI Considerations	13
Section 3 – Unpacking & Installation	15
Shipping Carton Contents	17
DPC Placement	17
Benchtop	17
Rack Mounting.....	18
Rear Panel Overview	19
Ground the System.....	19
Connect the Cables	20
Hand Probe System	20
Automated Probe System	20
Multiple Probe System	22
Automated Thruster System	23
Dukane Press System	24
Emergency Stop Switch Interface	25
Rear Electrical Power Switch	25
Section 4 – Controls & Displays	27
Front Panel Layout	29
AC Power	30
Generator Status Section	30
Generator Control Keys.....	30
System Status Display	31
System Power Output Display	32
Process Control	33
Process Control Keys	33
Menu Display	35

Section 5 – Rear Connectors	37
Rear Panel Layout	39
System Input Connector	40
System Output Connector	42
Remote Amplitude Control	46
Power Output Module Option	47
Press Control Module Option	48
Multi–Probe Module Options	50
Jumper Block Options	51
Card Slot and Jumper Block Locations	52
Jumper Block Details	53
Section 6 – Menu Structure	55
Process Setup	57
Process Control	58
Process Limits	60
Utilities	61
Section 7 – Process Setup Menu	63
Hand Probe	65
Untimed Hand Probe	66
Timed Hand Probe	66
Timed Hand Probe – Energy	67
MPC Probe	68
Auto Stop Option	68
Untimed MPC Probe – Probe Delay	68
Weld Method – Time	69
Weld Method – Energy	70
Weld Method – Ground Detect	70
Auto Probe	71
Auto Stop Option	72
Untimed Auto Probe – Delay	73
Timed Auto Probe – Weld Method	73
HoldTime	73
Afterburst	73
Press Mode	75
Initiate Mode	76
Auto Stop	76
Head Up On Auto Stop	76
Trigger Type	76
Single/Dual Pressure Mode	76

Press Mode Example	77
Hot Keys	81
Process Control Recap	82
Section 8– Process Limits Menu	87
Process Limits Menu	89
Limit Definition	90
Suspect and Bad Limits	90
Process Limits	90
Single Pressure Mode	91
Dual Pressure Mode	92
Section 9 – Utilities Menu	95
Setup Utilities	97
Select Setup	98
Copy A Setup	99
Erase Setups	99
Part Count	100
Reset Part Count	100
Count Suspect/Bad Parts	100
Preset Part Count	101
Status Outputs	101
Cycle Press Off Line	101
Section 11 – Probes/Probe Stacks	103
The Ultrasonic Probe	105
Theory of Operation	105
Probe Configuration	105
Ultrasonic Horn	106
Booster	106
Stack Assembly	107
Installing Replaceable Tips	107
Mounting Stud to Horn/Booster	108
Horn to Booster	109
Booster to Probe	109
Horn to Probe	109
Torque Unit Conversion Chart	110
Stack Disassembly	111
Booster Notes	114
Stack Mounting	115

Section 11 – DPC Checkout	117
Startup and Self-Test	119
System Test	120
Probe Operation	121
Stopping the Weld Cycle	121
Manual Systems	121
Automated System	121
End of Day	121
Section 12 – Troubleshooting	123
No Ultrasonic Output	125
Probe	125
Cable	125
Generator	126
Operate Input	126
Generator Faults.....	127
OVERLOAD Indicator	127
OVERTEMP Indicator	127
FAULT Indicator	127
Generator Errors.....	128
INPUT TEST Indicator	128
TEST Control Key.....	128
Troubleshooting Flowchart	129
Error Messages	131
Section 13 – Care & Maintenance	133
Front Panel	135
Rear Panel.....	135
Chasis	135
Stack Surfaces	136
Stack Maintenance	136
Stack Inspection	136
Even Contact	136
Uneven Contact	136
Crowning	137
Center Depression.....	137
Corrosion	137
Probe Reconditioning	138
Overview	138
Machining the Mating Surfaces.....	138
Manual Resurfacing.....	138

Section 14 – Contacting Dukane	141
Ultrasonics Division Main Office	143
Email Addresses	144
Telephone Extensions	144
Section 15 – Specifications	145
Regulatory Compliance	147
Federal Communications Commission	147
CE Marking (Conformité Européene)	147
Dimensions	148
Operating Environment	148
Power Requirements	149
Interpreting The DPC Model Number	150
Section 16 – Warranty	151
Domestic warranty	153
International Warranty	154
Appendix A - List of Figures	155
Appendix B - List of Tables	159
Appendix C - User Supplied Circuitry	161
Manual Switch Circuit	163
Automation Switch Circuits	164
Isolated Automation Controls	165
Current Sink	166
Current Source	167
Index	169

This page intentionally left blank

Introduction

- General Information
- Manual Organization
- DPC-II Plus Overview
- Key DPC-II Plus Features
- Key EZ Welder Features

Before Operating	3
Read The Manual First	3
Caution and Warnings	3
Drawings Labels	3
Manual Organization	4
DPC-II Plus Overview	6
EZ Welder™ Overview	6
Key DPC-II Plus Features	7
Key EZ Welder™ Features	8

This page intentionally left blank

Important User Information

Read This Manual First

Before operating the DPC™ II Plus, read this User's Manual to become familiar with the system. This will ensure correct and safe operation. The manual is organized to allow you to learn how to safely operate an ultrasonic system. The examples given are chosen for their simplicity to illustrate basic setup procedures.

Notes and Tips

Throughout this manual we use NOTES to provide information that is important for the successful application and understanding of the product. A NOTE block is shown to the right.

Cautions and Warnings

In addition, we use special notices to make you aware of safety considerations. These are the CAUTION and WARNING blocks as shown here. They represent increasing levels of important information. These statements help you to identify and avoid hazards and recognize the consequences. One of three different symbols also accompany the CAUTION and WARNING blocks to indicate whether the notice pertains to a condition or practice, an electrical safety issue or a hand protection issue.

Drawings and Tables

The figures and tables are identified by the section number followed by a sequence number. The sequence number begins with one in each section. The figures and tables are numbered separately. The figures use arabic sequence numbers (e.g. -1, -2, -3) while the tables use roman sequence numerals (e.g. -I, -II, -III). As an example, Figure 3-2 would be the second illustration in section three while Table 3—II would be the second table in section three.

NOTE

NOTE statements provide additional information or highlight procedures.

CAUTION



CAUTION statements identify conditions or practices that could result in damage to the equipment or other property.

WARNING



WARNING statements point out conditions or practices that could result in personal injury or loss of life.



Condition
or Practice



Electrical
Hazard



Hand
Hazard

Manual Organization

- Section 1 – Introduction** describes the manual organization and the key features of the Dukane DPC™ (Dynamic Process Controller) II Plus Generator.
- Section 2 – Safety** discusses OSHA regulations and safety considerations.
- Section 3 – Unpacking and Installation** explains the DPC II Plus placement and setup. It also shows the cable connections for quick-start operation.
- Section 4 – Controls** describes the function of the front panel controls, menu keys and status display.
- Section 5 – Connectors** gives the function, pinout and signal description of the rear panel connectors on the DPC II Plus. Operation of the optional modules is described in detail. The internal jumper blocks to control process automation are also identified.
- Section 6 – Process Setup** describes the overall menu organization of the DPC–II Plus, the setup and operate modes and gives a brief summary of the three main menus.
- Section 7 – Process Control Menu** describes the Hand Probe, Timed Auto, MPC and Press mode menus and the Weld Methods. It also covers the user interface configuration and parameter values.
- Section 8 – Limit Definition Menu** describes the Suspect Limit and Bad Limit menus in detail.
- Section 9 – Utilities Menu** describes the Setup File Utilities, Part Count and Status Output menus in detail.
- Section 10 – Hand Probe and Stack Assembly** describes the assembly and mounting of both hand probes and probe stack assemblies.
- Section 11 – System Checkout** describes basic system tests to ensure that the DPC II Plus is functioning properly.

Section 12 – Troubleshooting provides helpful tips on solving the most common problems.

Section 13 – Maintenance lists a schedule of suggested preventive maintenance items.

Section 14 – Contacting Dukane provides information on contacting or obtaining support from your Dukane Ultrasonics team.

Section 15 – Specifications lists the DPC–II Plus dimensions, power and space requirements. It also interprets the model number coding.

Section 16 – Warranty contains a copy of our equipment warranty and tooling warranty.

Appendices

- A** – **List of Figures.**
- B** – **List of Tables.**
- C** – **Sample Circuitry** for user supplied automation.

Index

DPC II Plus Overview

The DPC™ II Plus is the newest model in Dukane's Dynamic Process Controller product family. This system will accept a wide variety of optional modules and is designed for use with ultrasonic presses or applications that require the use of hand probes or thruster systems.

The DPC II Plus provides basic system control inputs and system monitor and status outputs. This makes the DPC II Plus ideal for automated control systems. Signal conditioning and electrical isolation are also provided.

Like other DPC models, the II Plus includes the same internal ultrasonic generator circuitry and features. Optional modules are available to enhance the DPC's ability to meet a wide variety of process requirements. The most common combination includes the Timer board and a Press control board. Other options include an Remote Amplitude control, a Power Signal module for Weld-by-Energy requirements and up to two Multi-Probe controller modules (DPC II Plus only) for driving multiple probe systems. In most cases, DPC II Plus systems in the field can be upgraded on-site if they already have the standard Timer board.

All DPC II Plus generators (except the highest power models) and the EZ/EZ-X Model 1000 feature a universal power supply with dual line-voltage¹ input. In addition, the equipment is designed and tested to comply with FCC and CE regulations that apply to this product.

¹ See Tables 15—I and 15—II

EZ Welder™ Overview

The EZ Welder™ system combines the best features of the DPC II Plus ultrasonic generator with a quality press in a matched, low-cost welding system. The generator and press are sold as a package and are not upgradable or interchangeable with other Dukane generators.

The EZ and EZX Welders are both single-pressure systems. The EZX model adds an energy mode and features additional limit switches for pretrigger and end-of-weld indication. The EZ Welder press has a maximum stroke of 5-inches.

DPC II Plus™ Key Features

- **Timer Board** option provides weld and hold time control and stores up to eight setup files.
- **Press Board** option provides control for a Dukane ultrasonic press and thruster.
- **Multi-Point Control Module** option permits one DPC to handle up to eight probes in an automation environment (DPC II Plus or DPC II).
- **Plug and Weld** system recognizes when modules are added or removed from the system
- **Process Control Menu** automatically reconfigures the user interface to conform to the modules or hand probes currently installed.
- **4-Line LCD Display** gives the complete parameter setting to speedup the setup process.
- **System Connections** are provided for automation equipment to monitor and control the ultrasonic welding process.
- **Modular Design** simplifies upgrades and increases flexibility as your application requirements change.
- **Flow Through Cooling Tunnel** is thermostatically controlled to reduce thermal gradients and increase component life. Fan runs only when required to minimize dust buildup.
- **Pulse Width Modulation** is Dukane's patented circuitry that allows the DPC power supply to efficiently control the voltage sent to the transducer in the acoustic stack.
- **Linear Ramp Softstart** circuitry is provided allowing the acoustic stack to be brought to operating amplitude smoothly, minimizing the startup shock stress.
- **Auto-Trac Tuning** automatically tracks the resonant frequency of the acoustic stack (horn, booster, transducer), and adjusts the generator output frequency to match it. ²

(continued on next page)

² Within specified ranges

- **Dual Line–Voltage ¹ Universal Power Supply** means that the DPC will operate worldwide. Auto-Ranging means that adjustments by the operator related to power input are unnecessary.
- **Line Voltage Regulation** automatically maintains a constant output regardless of line voltage deviation. ²
- **Load Regulation** provides constant amplitude automatically up to the rated overload power level.
- **Electronic Overload** protection prevent component failure.
- **CE Certification** means that the DPC II Plus and DPC EZ meets the required European standards to be sold and used in Europe.
- **ISO 9001 Certification** means that the DPC II Plus and EZ are manufactured to very high quality standards and assures you of Dukane’s commitment to being a quality vendor and its goal of continuous improvement.

¹ See Tables 15—I and 15—II

² Within specified ranges

EZ Welder™ Key Features

- **DPC Based** generator means a rugged, quality system for reliable operation.
- **Narrow–Profile Press** (4.5 inches) for close spacing in multihead and automation installations.
- **Top–of–Stroke** limit switch output for automation applications.
- **Chrome plated** press column and aluminum alloy–booster are standard.
- **Cast Aluminum** heavy–duty base for stability.
- **Calibrated dynamic trigger** system with LED indicator initiates the weld cycle at user selectable force.
- **Pneumatic stroke speed** adjustment on press controls horn travel velocity to workpiece.
- **Hinged press transducer door** for quick tooling changeover.

Safety Tips

- Health & Safety
- RFI Considerations

Health & Safety Tips	11
Plastics Health Notice	12
Electrical Grounding Safety	12
RFI Considerations	13

This page intentionally left blank

Health and Safety Tips

Please observe these health and safety recommendations for safe, efficient, and injury-free operation of your equipment. In this manual, the term *system* refers to a complete group of components associated with the welding of plastic or metal parts, also known as an *ultrasonic assembly system*. A typical system consists of a generator and/or ultrasonic process controller, start and stop switches, power controls, connecting cables, and the probe assembly which includes the transducer, booster, horn and replaceable horn tip.

Proper Installation – Operate system components only after they are properly installed and checked.

No Unauthorized Modifications – Do not modify your system in any way unless authorized to do so by Dukane Corporation. Unauthorized modifications may cause injury to the operator and/or equipment damage. In addition, unauthorized modifications will void the equipment warranty.

Keep the Cover On – Do not remove the equipment cover unless specifically directed to do so by Dukane Corporation. The generator produces hazardous electrical voltages which could cause injury.

Grounded Electrical Power – Operate this equipment only with a properly grounded electrical connection. (See Electrical Safety Grounding Instructions on the next page.)

Comply with Regulations – You may be required to add accessories to bring the system into compliance with applicable OSHA regulations.



IMPORTANT

Never operate the DPC II Plus with the cover off. This is an unsafe practice and may cause injury.



CAUTION

Parts being joined ultrasonically sometimes vibrate at audible frequencies. Wear ear protection to reduce annoying or uncomfortable sounds. In addition, sound absorbing materials, enclosures or sound deflectors may be installed to reduce the noise level.

Plastics Health Notice

Before using any Dukane ultrasonic welding system, be sure you are familiar with OSHA regulations from the U.S. Department of Labor about the particular type of plastic(s) you are using.

When plastic materials are being processed, they may emit fumes and/or gases that could be hazardous.

Make sure there is proper ventilation whenever these plastics are processed.

Electrical Safety Grounding Instructions

For safety, the power cords used on all Dukane products have a three-prong, grounding-type plug.

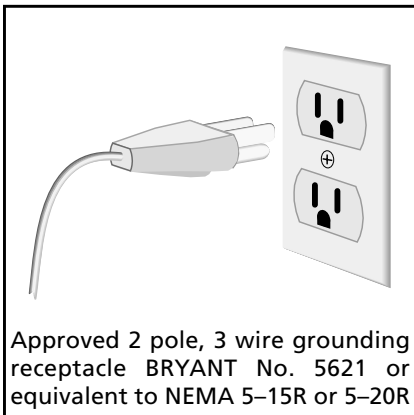

Approved 2 pole, 3 wire grounding receptacle BRYANT No. 5621 or equivalent to NEMA 5-15R or 5-20R

Figure 2-1 Example of 120 Volt, Grounded, 3-Prong Receptacle

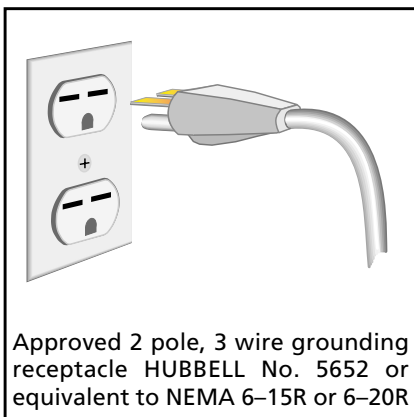

Approved 2 pole, 3 wire grounding receptacle HUBBELL No. 5652 or equivalent to NEMA 6-15R or 6-20R

Figure 2-2 Example of 220 Volt, Grounded, 3-Prong Receptacle

CAUTION



If you must have a two-prong electrical receptacle, we strongly recommend that you replace it with a properly grounded three-prong type. Have a qualified electrician replace it following the National Electric Code and any local codes and ordinances that apply. See Figures 2-1 and 2-2.

CAUTION



If there is any question about the grounding of your receptacle, have it checked by a qualified electrician. Do not cut off the power cord grounding prong, or alter the plug in any way. If an extension cord is needed, use a three-wire cord that is in good condition. The cord should have an adequate power rating to do the job safely. It must be plugged into a grounded receptacle. Do not use a two-wire extension cord with this product.

The power cable normally provided for international use is compatible with many power outlets (refer to Figure 2-3.) However, if your application requires another type of cable, check with the local Dukane products representative, and follow local regulations concerning proper wiring and grounding.

RFI Considerations

In addition to the safety considerations, proper grounding at the generator power cord is essential for the effective suppression of RFI (Radio Frequency Interference). Every DPC contains a RFI filter which blocks noise on the AC power line from entering the DPC control circuitry. This filter also prevents ultrasonic RFI from being fed back into the AC power line. In order for the RFI filter to operate properly, it is necessary to adequately ground the DPC. Run an additional grounding wire from the rear grounding connection (see Figure 2-4) to the nearest grounded metal pipe or equivalent earth ground by means of a ground clamp. Use at least an 14 AWG** wire for the connection to the DPC chassis. Stranded is more flexible and easier to work with than solid wire. However if you use stranded wire, crimp spade lugs on the end to ensure a good connection. If you have a color choice, green is the commonly accepted color for an electrical ground connection.

If you have connected the DPC to a Press and/or Thruster, use a star † connection from the earth ground to the DPC and Press as illustrated in Figure 2-5.

** 14 AWG wire has a diameter of 1.63mm or 0.064"

† Run separate ground wires from each piece of equipment to the earth ground. See the appropriate schematic diagram in Figures 3-4 thru 3-8.

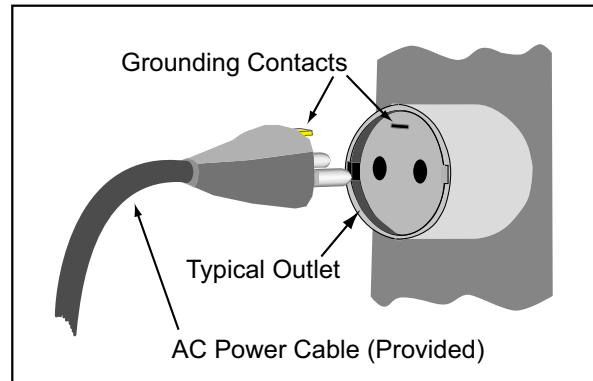

Figure 2-3 International 220/240V Grounding

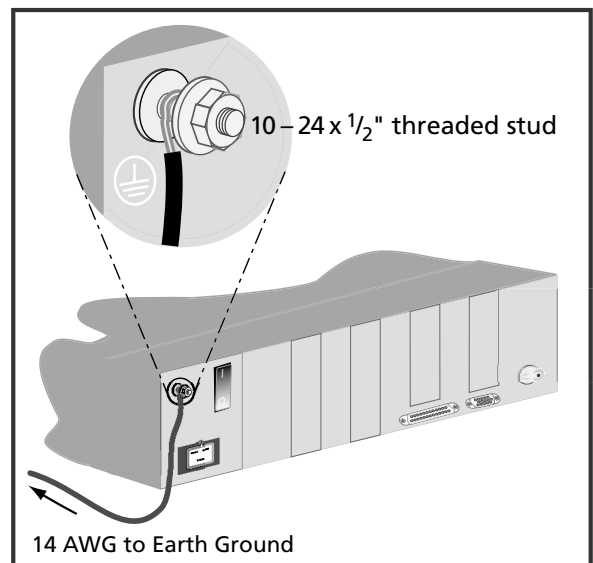

Figure 2-4 DPC Grounding Arrangement

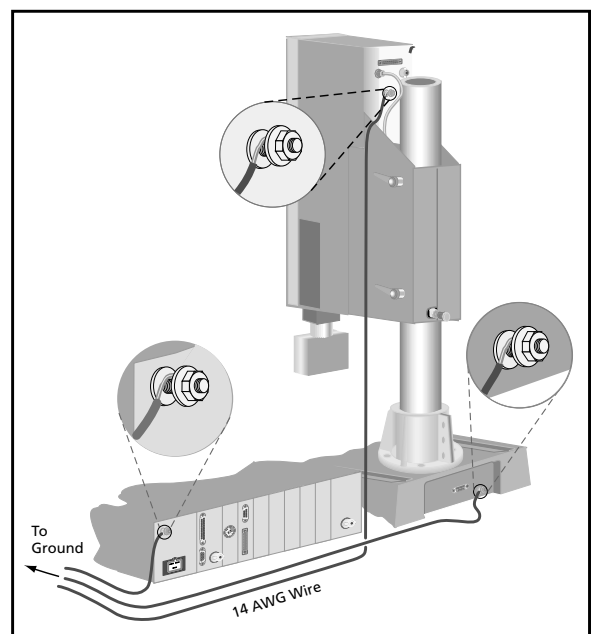

Figure 2-5 Press Grounding Arrangement

This page intentionally left blank

Unpacking & Installation

- Unpacking the DPC
- Placement of the DPC
- Rear Panel Overview
- Grounding the System
- Connecting the Cables

Shipping Carton Contents	17
DPC Placement	17
Benchtop	17
Rack Mounting	18
Rear Panel Overview	19
Ground the System	19
Connect the Cables	20
Hand Probe System	20
Automated Probe System	20
Multiple Probe System	22
Automated Thruster System	23
Dukane Press System	24
Rear Electrical Power Switch	25

This page intentionally left blank

Shipping Contents

Quantity	Item	Part Number
1	DPC II Plus or EZ Generator	**
1	DPC II Plus/EZ User's Manual	403-566-00

** DPC Part Number depends upon Frequency and Power Rating
AC power cord and cables as specified. See your Packing List.
Compare with Table 3—II on page 21.

Table 3—I Contents of DPC II Plus Shipping Container

Carefully open the shipping container, and make sure it contains the items shown in Table 3—I. Inspect the DPC for damage. Report any damage immediately to Dukane Ultrasonics Support/Service.

DPC Placement

Placement of the DPC depends on whether it is a benchtop or rack-mounted configuration

Benchtop

Place the DPC on a flat surface with its front panel easily accessible. Make certain the placement and cabling do not interfere with the assembly operation.

Allow 5 inches (13 cm) at the rear of the DPC for cable clearance. Allow 2 inches (5 cm) of space on either side of the DPC for air circulation. Refer to the illustration in Figure 3-1.



CAUTION

Allow space for air ventilation around the DPC II Plus chassis, the air intake and exhaust. The fan draws in fresh air to cool the internal components, reduce thermal gradients and increase component life. When viewed from the front, the fresh air intake is on the right and the hot air exhaust is on the left side.

If excessive dust accumulates in the slots, wipe or vacuum them clean. Do not use compressed air as this may force the dust inside the chassis.

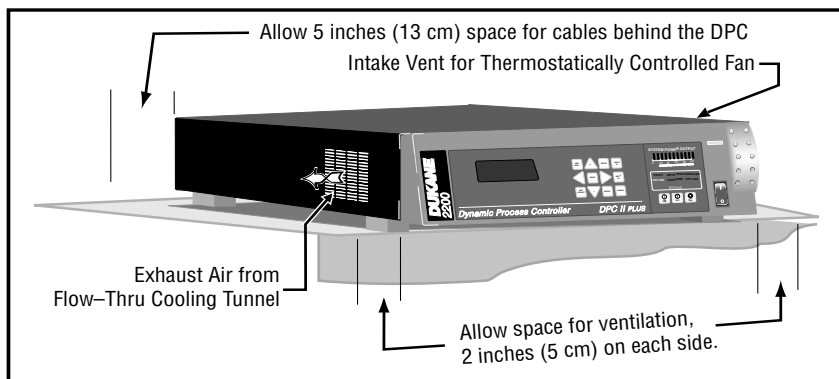

Figure 3-1 Installing a Benchtop DPC

Rack Mounting

Figure 3-2 shows the use of a bracket kit in mounting a DPC to a 19-inch equipment rack. (Contact Ultrasonic Sales at Dukane, and request Part Number US-1155.) The DPC illustrated has the standard, angled front panel of impact-resistant ABS plastic.

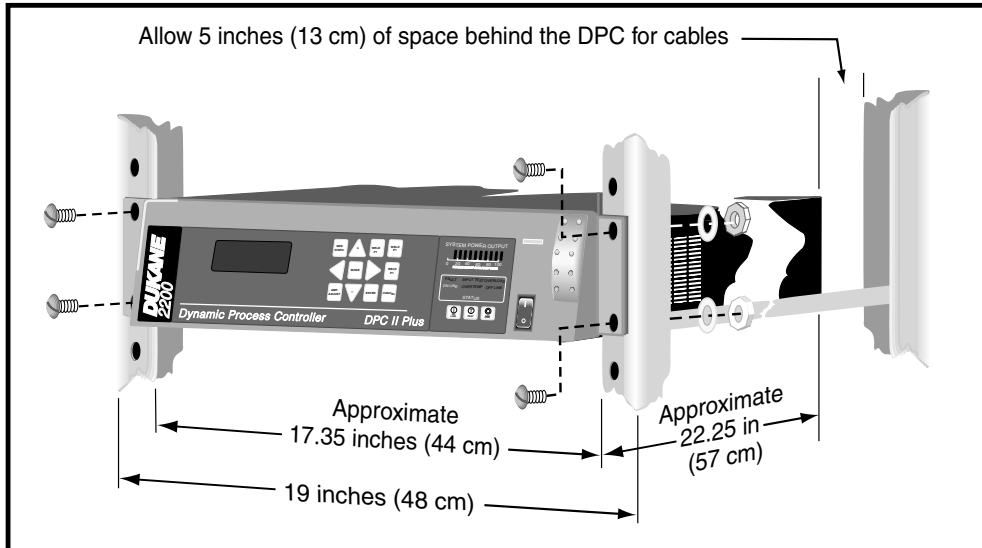

Figure 3-2 Rack-mounted DPC Using Bracket Kit

CAUTION

Allow space for air ventilation around the DPC II Plus chassis, air intake and exhaust. The fan draws in fresh air to cool the internal components, reduce thermal gradients and increase component life. When viewed from the front, the fresh air intake is on the right and the hot air exhaust is on the left side. If excessive dust accumulates in the slots, wipe or vacuum them clean. Do not use compressed air as this may force the dust inside the chassis.

Rear Panel Overview

Familiarize yourself with the connection points for power, ground, ultrasound output, system I/O and the optional modules on the rear of the DPC II Plus shown below in Figure 3–3. The standard modules and connectors are labeled with the black boxes. The optional modules are labeled with italics. The EEPROM Serial Programming Port is used to upgrade the DPC™ firmware. The grounding lugs, serial number tags, etc. are located in the same position on all DPC II, EZ Welder, DPC II Plus, DPC III and DPC IV generators.

NOTE

Not all of the modules illustrated below can be installed simultaneously. They are shown to represent the various configurations that can be assembled to meet specific requirements.

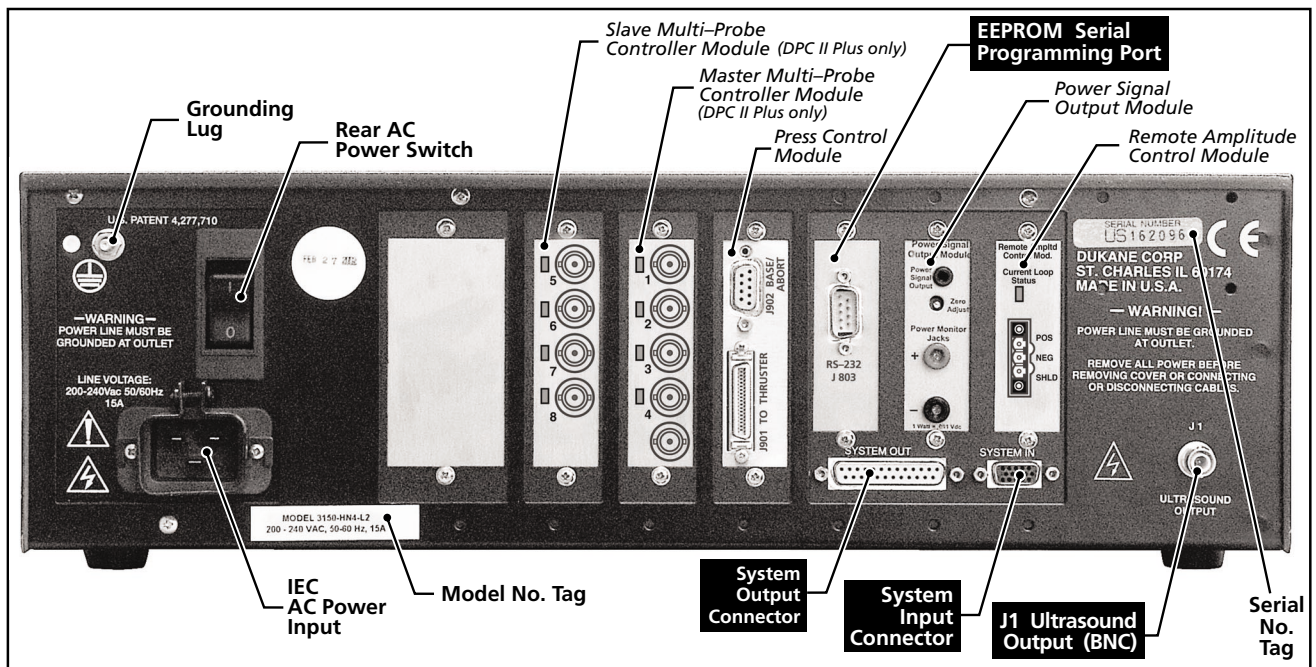
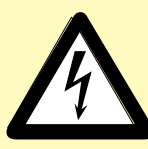

Figure 3-3 DPC II Plus and EZ Welder Rear Panel and Optional Modules

Ground the System

The DPC II Plus includes an internal RFI filter. The standard building AC ground connection is normally not sufficient to completely suppress the RFI. Attach a ground cable from the DPC grounding lug (located next to the rear AC power switch) to an earth ground. If you are using a press or automated probe system, each piece of equipment must also be solidly grounded. Refer to Figure 2–5 and Figures 3–4 through 3–8 for the proper grounding arrangement.

CAUTION



Before attaching the cables, make sure the DPC II Plus is properly grounded. Refer to Figure 2–5 and the appropriate diagram (Figures 3–4 thru 3–8) for the correct grounding connections.

Connect the Cables

The instructions here and the diagrams in Figures 3–4 through 3–7 are meant to serve as a quick-start guide. The connectors and their pinouts are discussed in greater detail in Section 5.

Manual Probe System

- Step 1. Ground the DPC II Plus chassis.
- Step 2. Attach the System In adapter cable (see Figure 3–4) to the 14-pin AMP connector at the end of the probe cable.
- Step 3. Connect the other end of the adapter to the System In HD-15 connector on the rear of the DPC II Plus.
- Step 4. Attach the high voltage ultrasound coaxial cable to the rear-panel J1 connector.
- Step 5. *Optional – If your system has a Press Control Module, you will also need a jumper block (Part No. 200-1293) to replace the normally closed contact from the Emergency Stop safety switch.*
- Step 6. Attach the power cord to the DPC II Plus and plug the other end into an approved AC outlet.

Automated Probe System

- Step 1. Ground the DPC II Plus chassis and the probe support.
- Step 2. Attach the high voltage coax cable from the probe mount to the rear-panel DPC connector J1 (see Figure 3–5).
- Step 3. Connect the automation control cable from the user-supplied automation equipment to the System Input rear panel HD-15 connector (Figure 3–5).

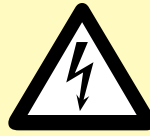

CAUTION

Make sure electrical power is OFF before connecting/disconnecting cables or installing/removing modules from the DPC II Plus. Make sure **BOTH** the front and rear panel AC power breaker switches are in the OFF position. Failure to turn off the power may result in damage to the DPC and/or the modules.



CAUTION

The power cord is equipped with a three-prong, grounded-type plug for your safety. Whenever a two-slot receptacle is encountered, we strongly recommend that it be replaced with a properly grounded three-lead receptacle. Have a qualified electrician perform the installation in accordance with the National Electrical Code and local codes and ordinances. **DO NOT** cut off the AC power cord grounding prong or alter the plug in any way.

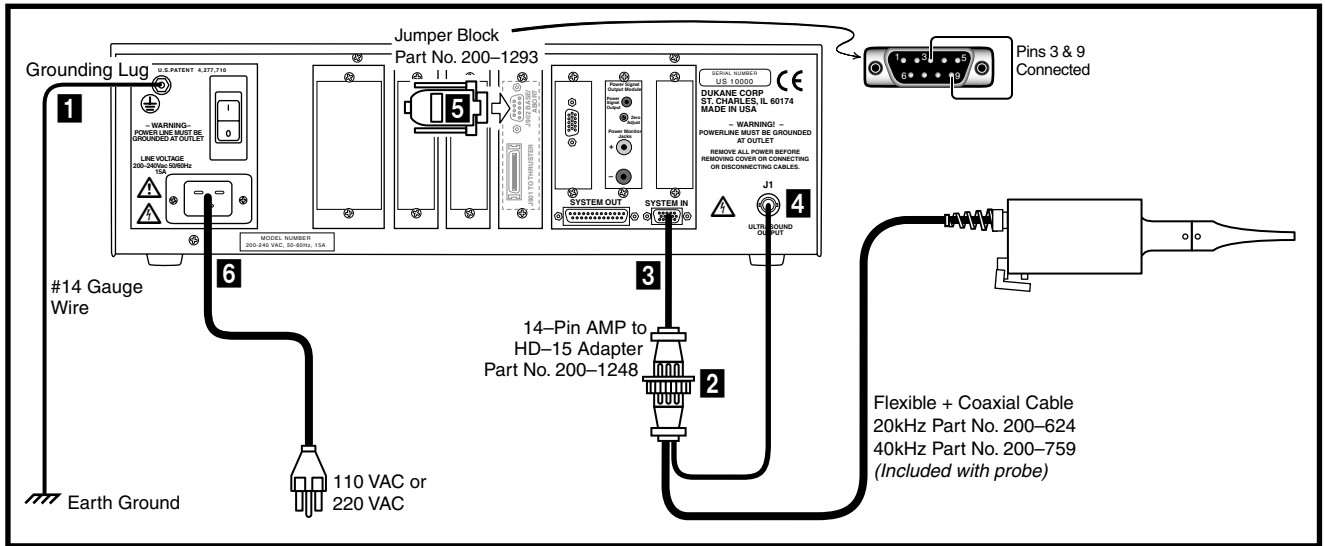

Figure 3-4 DPC II Plus and EZ Welder Hand Probe Cable Connections

- Step 4. *Optional – Attach the status output cable from the user-supplied automation equipment to the System Output DB-25 connector. Not all automation systems will have this cable.*
- Step 5. Attach the power cord to the DPC II Plus and plug the other end into an approved AC outlet.

The 3-prong AC Line cords supplied are matched to the DPC II Plus power rating and the continent of specified use. The part numbers are —

200-1109	North America 110V
200-1110	North America 220V
200-1111	Continental Europe

Table 3—II DPC II Plus AC Power Cord Part Numbers

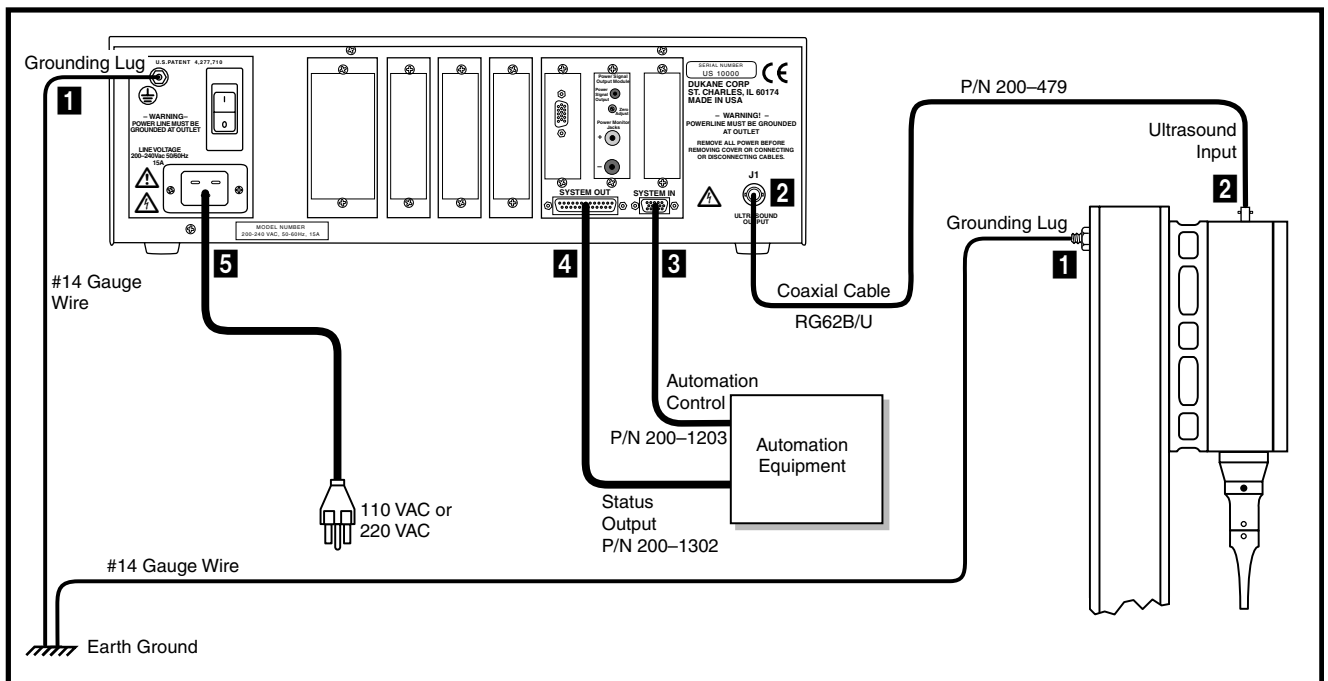
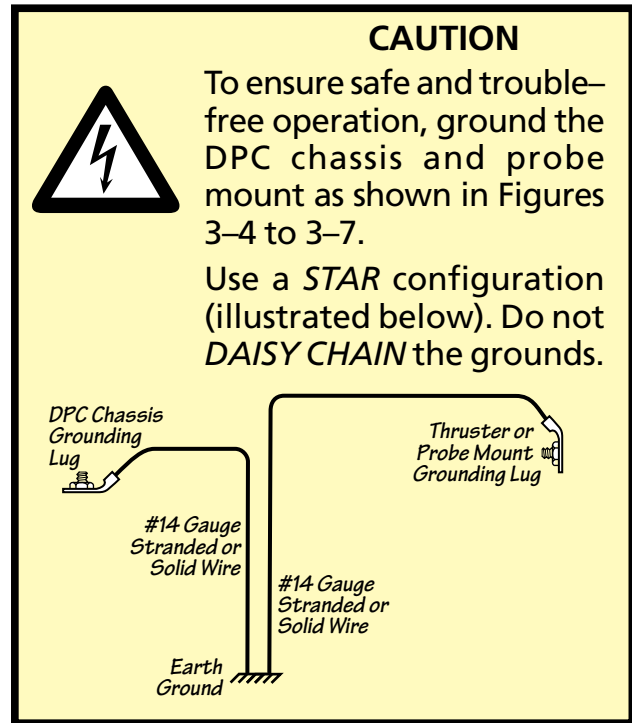

Figure 3-5 DPC II Plus and EZ Welder Automated Probe Cable Connections

Multiple Probe System

- Step 1. Ground the DPC II Plus chassis and the probe support.
- Step 2. First attach a short coaxial cable from the rear-panel DPC generator U/S output J1 (see Figure 3–6) to the MPC U/S input.
- Step 3. Attach another high voltage coax cable from the rear MPC channel 1 probe output to the first probe. Attach a separate cable from each output channel to each probe.
- Step 4. Connect the automation control cable from the user-supplied automation equipment to the System Input rear panel HD-15 connector.
- Step 5. Attach the status output cable from the user-supplied automation equipment to the System Output DB-25 connector.
- Step 6. Attach the power cord to the DPC II Plus and plug the other end into an approved AC outlet.



NOTE

The automated system cabling schematics in Figures 3–5, 3–6 and 3–7 are intended to represent connections for a typical automation system. Your system cabling may vary slightly from the diagrams.

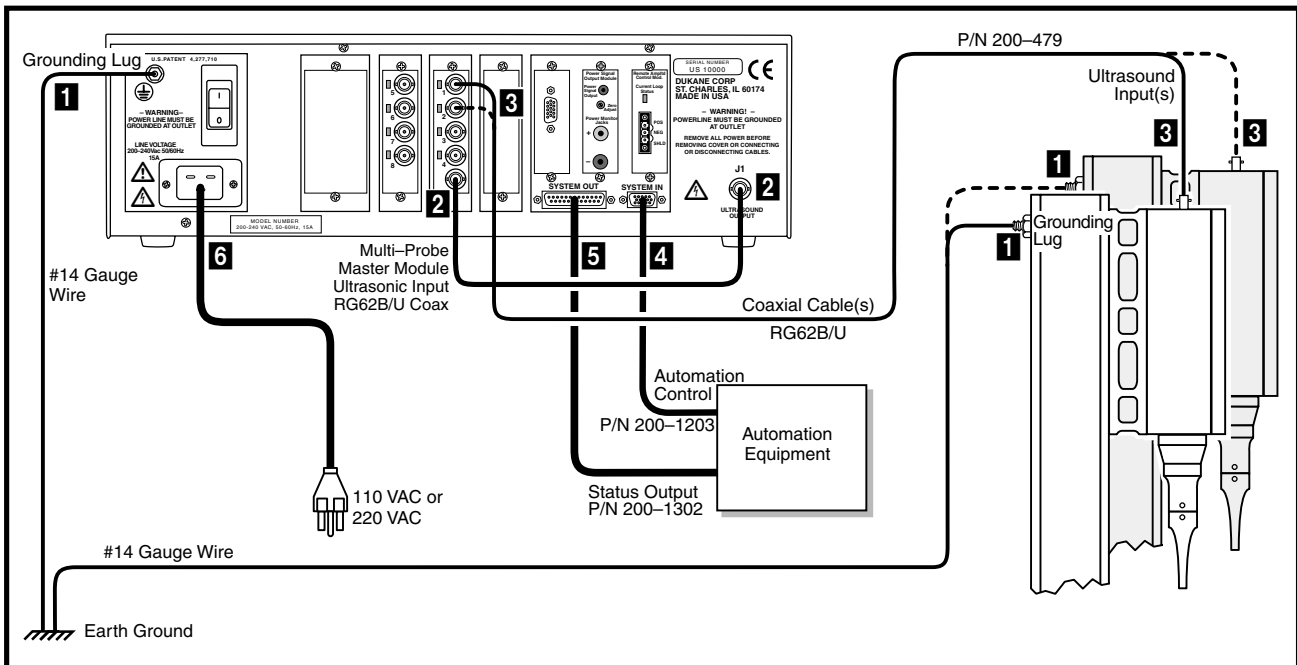

Figure 3-6 DPC II Plus Multiple Probe Controller Cable Connections

Automated Thruster System

- Step 1. Ground the DPC II Plus and the Thruster as shown in Figure 3–7.
- Step 2. Attach the high voltage RG62B/U coax cable from the rear-panel DPC II Plus connector J1 to the ultrasound input J1 on the thruster (see Figure 3–7).
- Step 3. Connect the Automation Control cable from the user-supplied automation equipment to the System Input rear panel HD-15 connector.
- Step 4. Attach the Status Output cable from the user-supplied automation equipment to the Status Output DB-25 connector.
- Step 5. Connect the Press Base Input cable from J35 on the Press Base to the DB-9 connector (J902) on the Press Control Module. If the automation system does not have a connection to J902, you may need a jumper block (Part No. 200-1293) to replace the normally closed contact from the press base Emergency Stop safety switch.
- Step 6. Connect the Operational Control cable from the user-supplied automation equipment to the 36-contact Thruster control connector (J901) on the Press Control Module.
- Step 7. Attach the power cord to the DPC II Plus and plug the other end into an approved AC outlet.

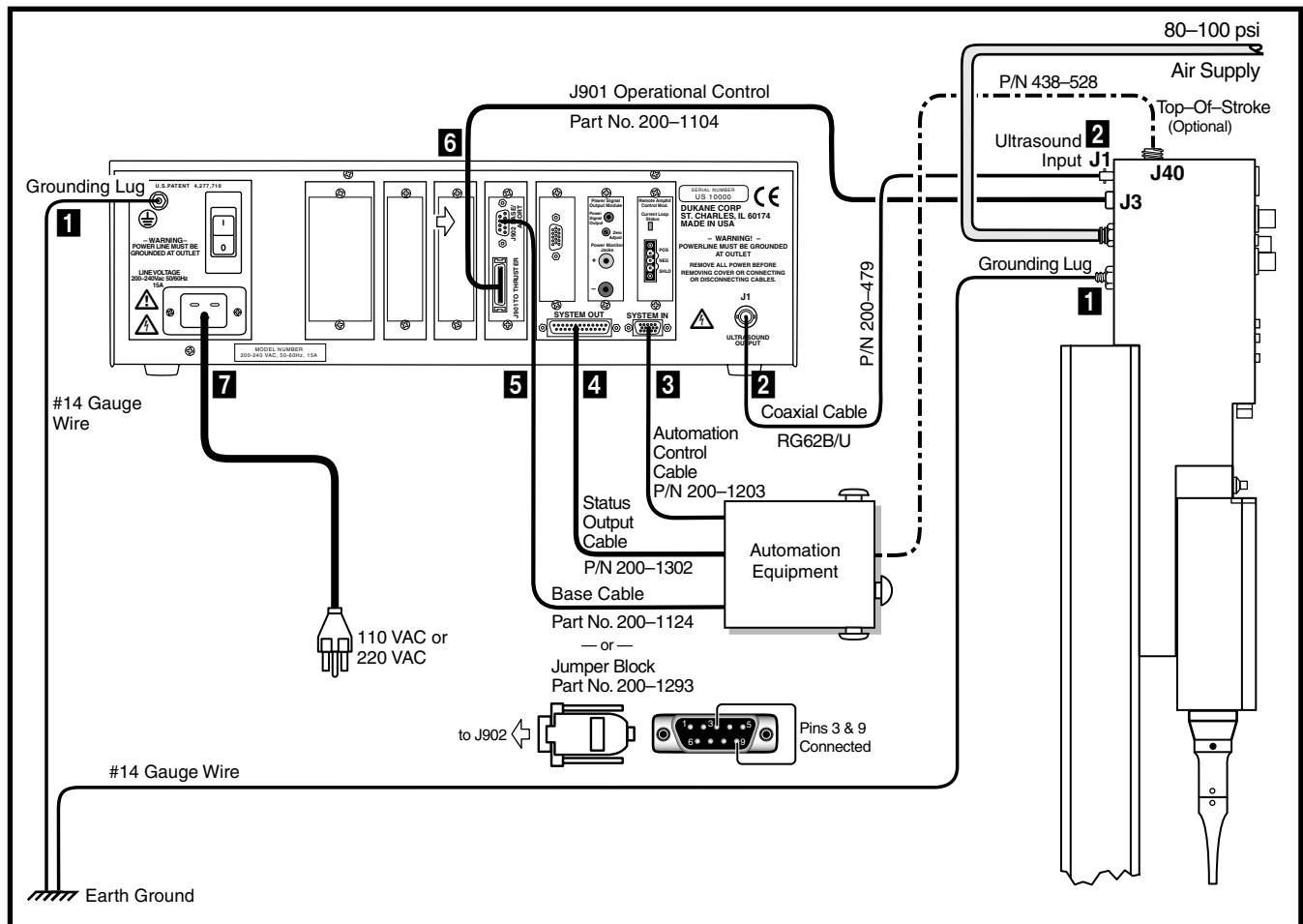

Figure 3-7 DPC II Plus Automated Thruster Cable Connections

Dukane Press System

- Step 1. Ground the DPC II Plus, the Thruster and the Base as shown in Figure 3–8.
- Step 2. Attach the high voltage coax cable from the press J1 connector to the DPC Ultrasound Out connector (J1).
- Step 3. Connect the Press Base Input cable from J35 on the Press Base to the DB-9 connector (J902) on the Press Control Module.
- Step 4. Connect the Operational Control cable from J3 at the top of the press to the 36–contact Thruster control connector (J901) on the Press Control Module.
- Step 5. Attach the power cord to the DPC II Plus and plug the other end into an approved AC outlet.

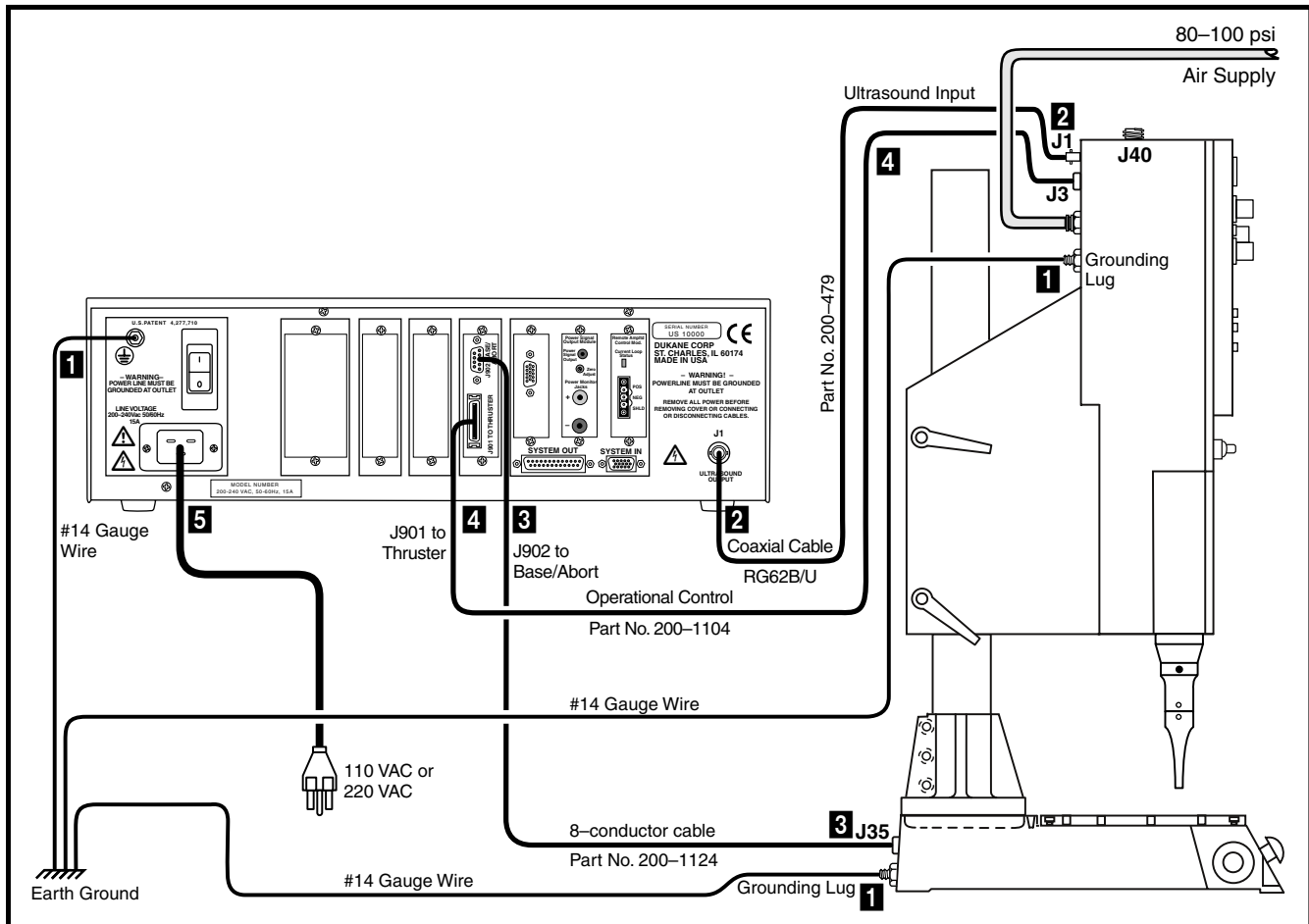
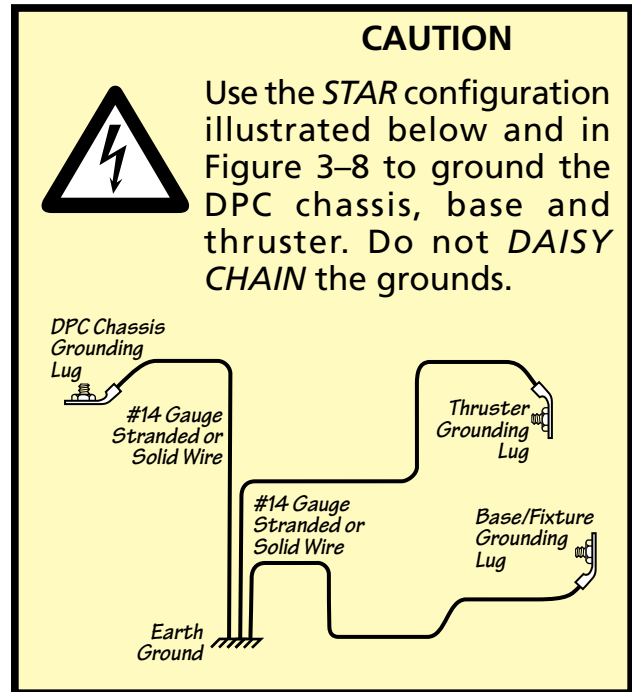

Figure 3-8 DPC II Plus and EZ Welder Press Cable Connections

Emergency Stop Switch

Figure 3–9 is a simplified example that demonstrates the basic requirements to interface with the DPC II Plus on J902. This is excerpted from Application Note AN201 available on our website. Note that the emergency stop inputs cannot just be tied together from multiple DPCs when used

on a common welding process. Multiple DPCs require individual contacts for each unit.

Check with your local safety compliance office before altering the factory connections. The user is responsible for complying with all requirements of the safety regulatory agencies governing the geographic location where the Dukane equipment will be operated.

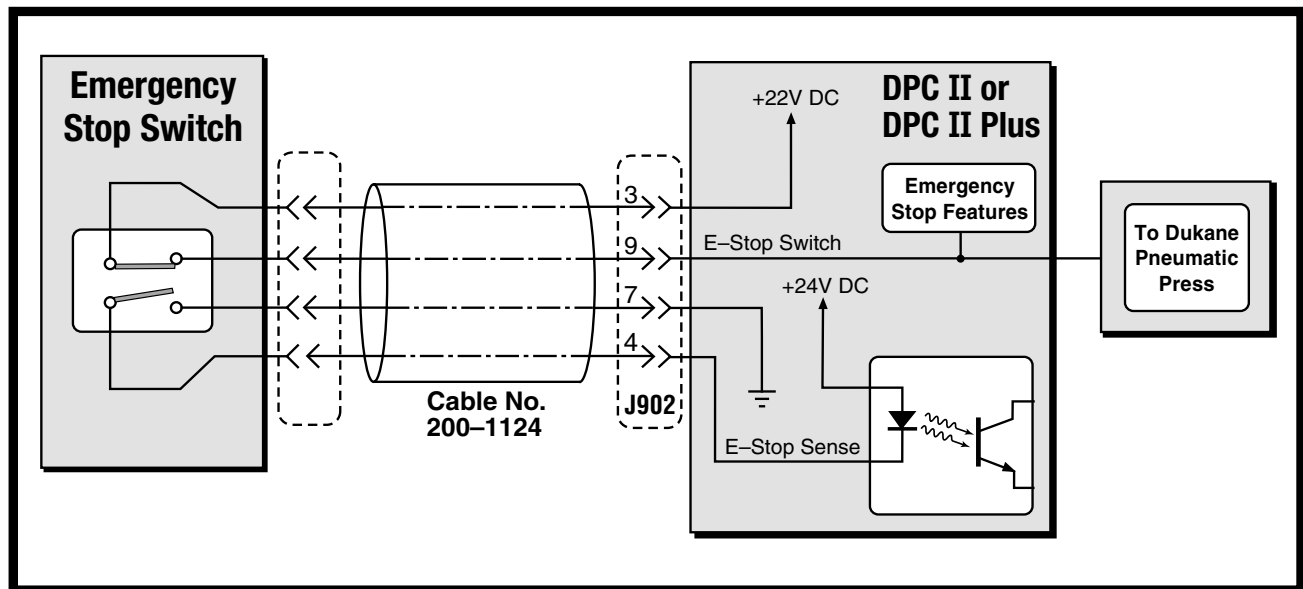

Figure 3-9 J902 Emergency Stop Interface Example

Electrical Power Switch

The rear panel AC breaker switch (Figure 3–10) is wired in series with the front panel breaker switch (shown in Figure 4-2). When the rear breaker switch is off, it isolates the AC power feed in the chassis for safety considerations. Both the front panel and rear panel switches must be on to supply AC power to the DPC generator.

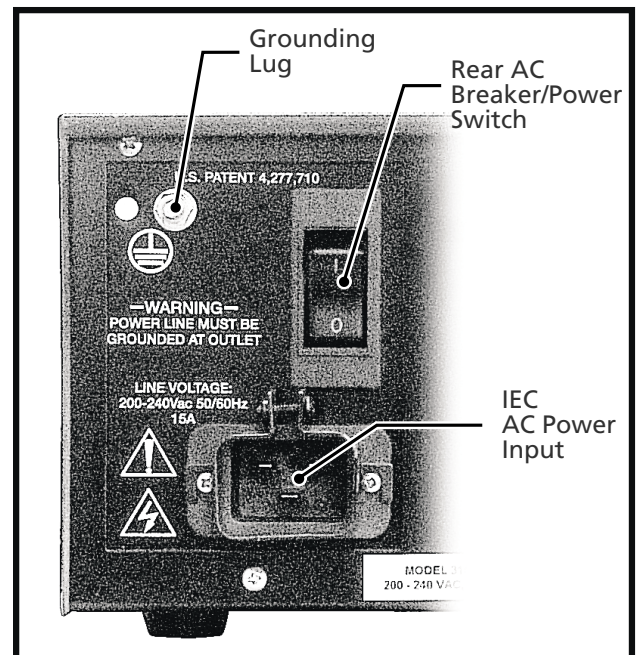

Figure 3-10 Rear Panel AC Breaker Switch

This page intentionally left blank

Controls & Displays

- Front Panel Layout
- AC Power
- Generator Status Panel
- Menu Function Keys
- Control Menu Display

Front Panel Layout	29
AC Power	30
Generator Status Panel	30
Generator Control Keys	30
System Status Display	31
System Power Output Display	32
Process Control Panel	33
Menu Function Keys	33
Control Menu Display	35

This page intentionally left blank

Front Panel Layout

This section describes the DPC II Plus and DPC EZ front panel controls, status, power output and menu displays.

The DPC front panel is laid out in three sections as illustrated below in Figure 4-1A (DPC II Plus) and Figure 4-1B (DPC EZ). The three sections are:

1. AC Power switch and indicator **A**
2. Generator Status Panel which contains
 - Three Generator Control keys **B**
 - System Status display **C**
 - System Power Output display **D**
3. Process Control Panel which contains
 - Menu Function keys **E**
 - LCD menu display **F**

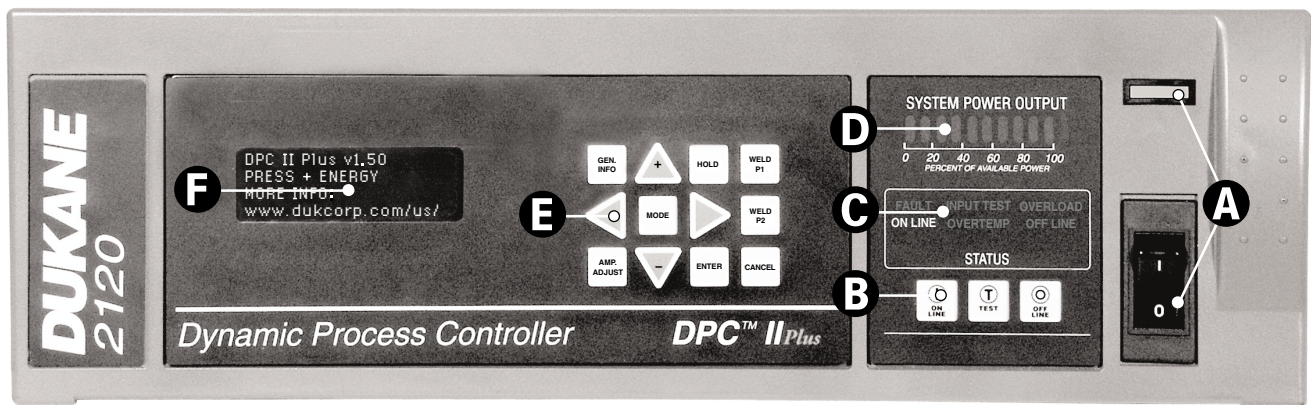

Figure 4-1A DPC II Plus Front Panel Layout

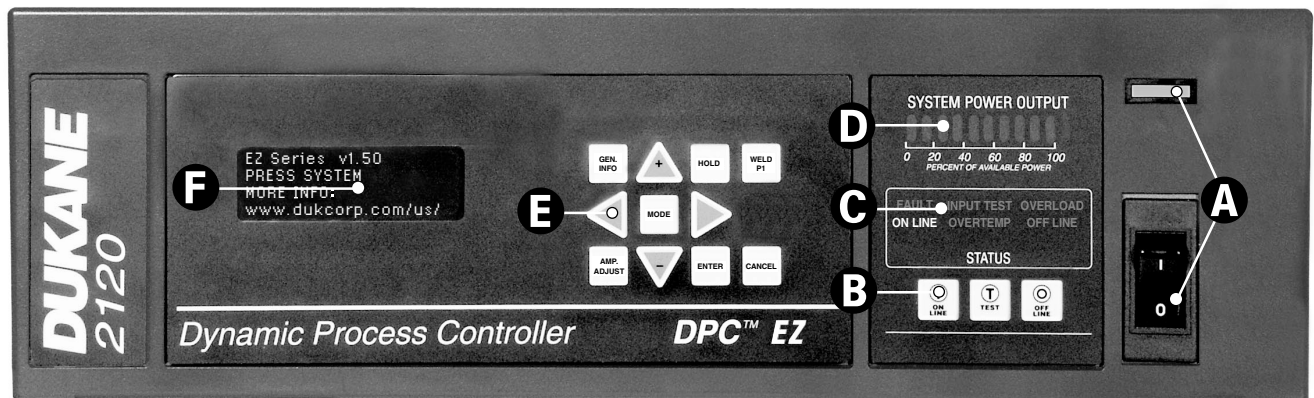

Figure 4-1B DPC EZ Front Panel Layout

1. AC Power Section

The front-panel AC power section has a switch and power indicator that is shown in Figure 4-2.

ON/OFF The AC power switch connects AC power to the generator. This breaker switch is wired in series with the rear panel power switch (Figure 3–9). It also serves as a circuit breaker that provides overload protection for the DPC. Both switches must be turned on to supply AC power to the generator.

Green LED The green indicator above the switch lights when the DC bus is up, after the AC power has been switched on. At this point the generator is capable of producing an ultrasonic output signal.

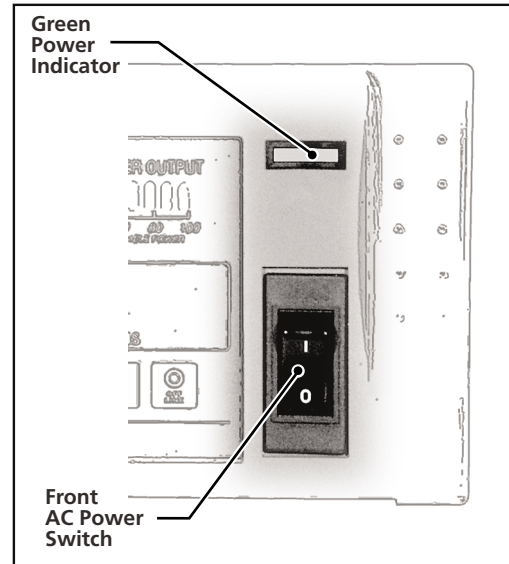

Figure 4-2 Front Panel AC Power Section

2. Generator Status Panel

The Generator Status Panel is subdivided into three sections which provide control and status displays.

1. Generator Control Keys
2. System Status Display
3. System Power Output Display

Generator Control Keys

The Generator Control Key section consists of three keys as shown in Figure 4-3.

ON LINE This places the generator in an operational state. It can produce an ultrasonic output signal when triggered.

TEST The TEST key momentary activates the generator to provide ultrasound output for test or setup purposes. TEST will only work in the ON LINE state.

OFF LINE This key places the generator in a standby mode. This prevents the generator from producing an ultrasonic output signal.

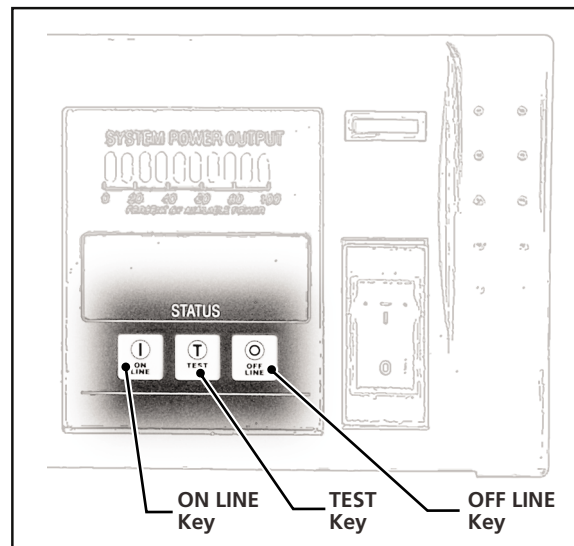

Figure 4-3 Generator Control Keys

NOTE

If a Press module is installed, these keys are only active if the Emergency Stop is not engaged. If the Emergency Stop switch is depressed, the System Status Display will not be lit and the Control Keys inactive.

System Status Display

The System Status Display indicates one of the six system states. If that state is active, the corresponding label is lit in the display. Figure 4-4 shows the System Status Display with the ON LINE state activated. The six status conditions are described here.

FAULT This indicator lights when out-of-tolerance voltage fluctuations occur that are related to one of the following conditions.

1. AC Line Voltage
2. Internal DC Power Supply (+5 VDC, +12 VDC, -12V DC or +24V DC.)

INPUT TEST This indicator normally flashes red during a power-up test. If there is a problem, a steady red light appears. This means that either the input AC line voltage is out of tolerance, or an internal fault has occurred in the generator.

OVERLOAD This red indicator lights when either of the following conditions occur.

1. An instantaneous overload caused by a mismatch between the ultrasonic signal and the resonant characteristics of the acoustic stack (transducer, booster and horn.)
2. Excessive power beyond the generator's rated output is being drawn.

ON LINE The generator is capable of operation.

OVERTEMP One of the power modules has overheated and the generator has shut down. This may be caused by excessive dust in the cooling channel or a cooling fan failure. The generator will automatically reset when the module temperature drops below the trip point which is 75°C (167°F).

OFF LINE The generator is in a standby mode. The ultrasound output cannot be activated.

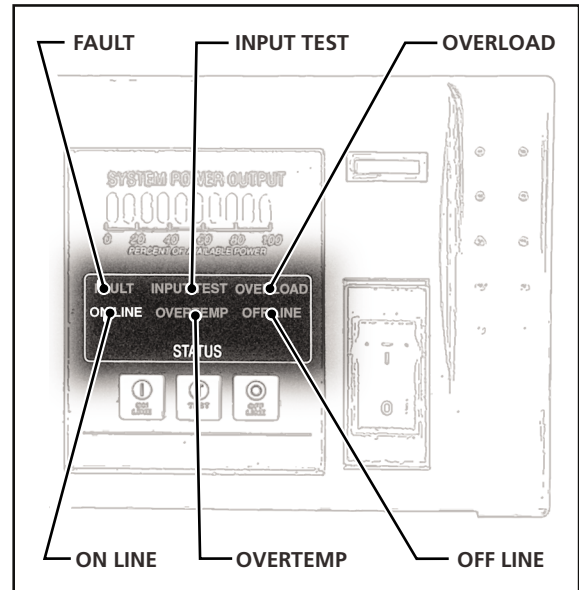

Figure 4-4 System Status Display

System Power Output Display

The tricolor System Power Output Display indicates the percentage of ultrasonic power being drawn by the load.

Green Eight green vertical bars indicating 10% to 80% power output are displayed during normal operation. Figure 4-5 shows the display indicating 80% output power.

Yellow Two yellow bars for 90% and 100% power output warn that the generator is operating near its maximum rated output.

Red The last red bar indicates that the generator is in an overload condition delivering more than its rated output power. Figure 4-6 shows the red overload and two yellow warning indicators. The red warning indicator lights up just prior to an overload condition. The ultrasonic signal is shut down when an overload condition occurs.

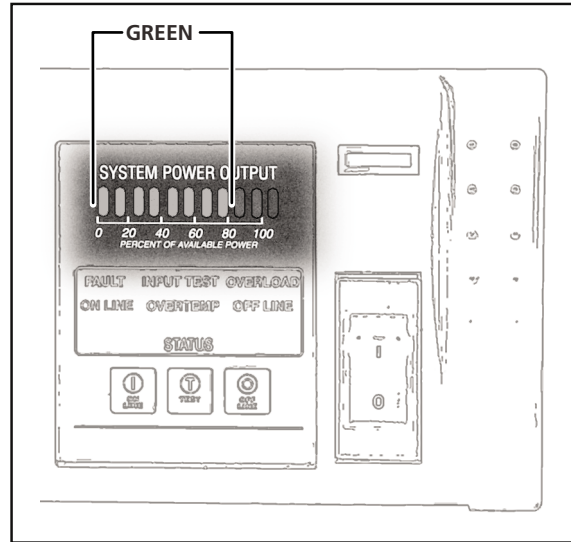

Figure 4-5 Normal Operation

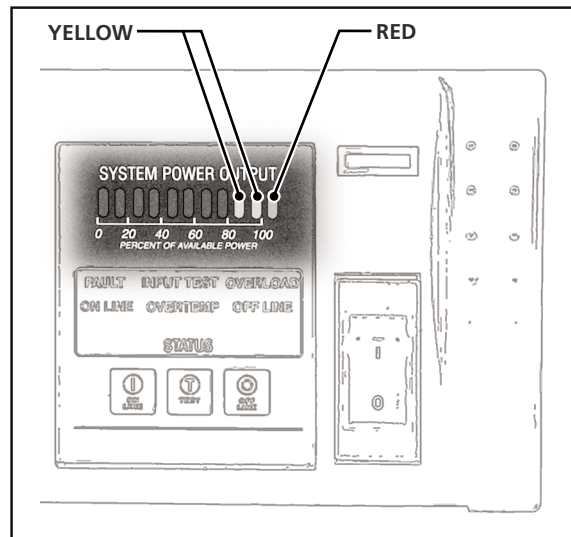

Figure 4-6 Warning Indicators



NOTE

The available output power is directly proportional to the Amplitude setting.

Example: A 2200 Watt rated DPC set to 80% Amplitude will overload at 1760 Watts.
 $(2200W \times 0.80 = 1760 \text{ Watts})$

3. Process Control Panel

Menu Function Keys

The menu keys are shown in Figure 4-7. Their function is described going across each row starting at the upper left.



Pressing the GEN. INFO key displays the DPC model, the firmware version and the installed modules. A readout for a DPC II Plus equipped with both a Press Control module and a Power Signal Output Module is shown in Figure 4-8A. The DPC EZ Series is shown in Figure 4-8B. Press CANCEL to return to the previous menu.



The up arrow key increments the data value each time it is pushed. Holding the key in continuously increments the value. This key is also used to move the cursor up one line on a menu selection screen



Pressing the HOLD key immediately brings you to the Hold Time data entry menu. You can quickly check and/or change the setting using the four arrow keys. Pressing ENTER completes the process and returns you to your last menu screen.



Pressing the WELD P1 key displays the parameter(s) for the first pressure setting. The value(s) can be quickly checked and/or altered without going back through the menu sequence. Pressing ENTER completes the process and returns you to your last menu screen.



Pressing the left arrow key selects the next digit to the left of a parameter setting. The key is used when entering values and moves the flashing bar under the selected digit. The selection wraps around to the right digit after the left most digit position is reached.

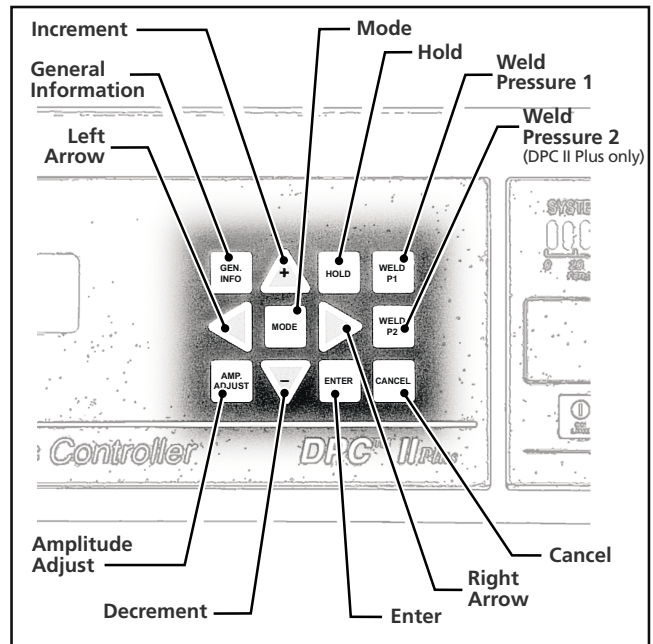

Figure 4-7 Menu Keys

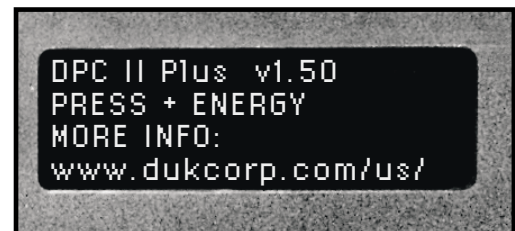

Figure 4-8A DPC II Plus GEN INFO Display

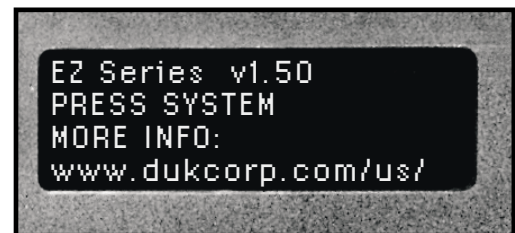

Figure 4-8B DPC EZ GEN INFO Display

NOTE

For three of the 'hot' keys (HOLD, WELD P1, and WELD P2), data can only be entered or modified after the programming setup is completed.



Pressing the MODE key toggles between the Weld mode (displays values for last weld cycle) and the Setup mode (displays main Process Setup menu).



Pressing the right arrow key selects the next digit to the right of a parameter setting. The key is used when entering values and moves the flashing bar under the selected digit. The selection wraps around to the left digit after the right most digit position is reached.



Pressing the WELD P2 (DPC II plus only) key displays the parameter(s) for the second pressure setting only if a dual pressure mode has been previously selected. The value(s) can be quickly checked and/or altered without going back through the menu sequence. Pressing ENTER completes the process and returns you to your last menu screen.



Pressing this key displays the current ultrasound amplitude setting. This can be adjusted from 40% to 100% using the up and down arrow keys marked + and - respectively. Press ENTER to confirm the value.



The down arrow key decrements the data value each time it is pushed. Holding the key in continuously decrements the value. This key is also used to move the cursor down one line on a menu selection screen



Pressing the ENTER key completes the menu operation and displays the next decision or navigation menu.



Pressing the CANCEL key discards any values you may have changed and returns you to the previous decision or navigation menu.

TIP

For any of the four 'hot' keys (HOLD, WELD P1, WELD P2 or AMP. ADJUST), pressing the CANCEL key instead of ENTER returns you to the last menu screen without altering the value.



NOTE

Reducing the amplitude with the AMP. ADJUST key reduces the maximum power available. If the amplitude is reduced to 40% (the lowest setting), the maximum available power will be limited to 40% of the rated output power.

Process Control Menu Display

The menu display is a backlit 4-line LCD with 20 characters per line. The top line of the display contains the menu title (with a few exceptions).

Selection Menus

The selection menus have a triangular cursor at the far right of the display. These menus may also be thought of as a decision menu. Move the cursor to the menu choice and press the ENTER key to select your choice. Pressing the CANCEL key returns to the previous selection menu. A typical selection menu is shown in Figure 4-9.

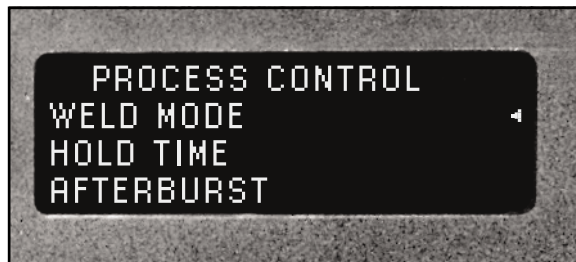

Figure 4-9 Typical Selection menu

Confirmation Menus

A confirmation menu requests a Yes or No entry to continue the process. Select YES from the menu and press the ENTER key to proceed. A typical confirmation menu is shown in Figure 4-10.

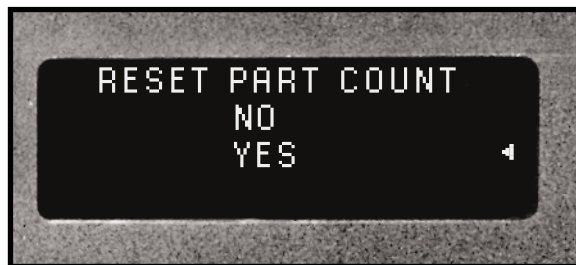

Figure 4-10 Typical Confirmation Screen

Data Entry Menu

The data entry screens have the parameter name on the first line and the parameter value on the third line. Use the left and right triangle keys to select the digit and the Increment (+) and Decrement (-) keys to change the value. Press the ENTER key to accept the value. A typical data entry screen is shown in Figure 4-11.

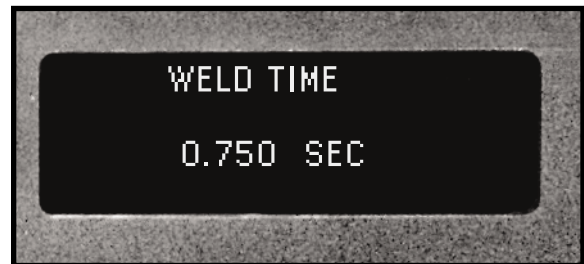

Figure 4-11 Typical Data Entry Screen

This page intentionally left blank

Rear Connectors

- Rear Panel Layout
- System Input
- System Output
- Optional Modules
- Internal Jumper Blocks

Rear Panel Layout	39
System Input Connector	40
System Output Connector	42
Remote Amplitude Control	46
Power Output Module Option.....	47
Press Control Module Option	48
Multi-Probe Module Options	50
Jumper Block Options	51
Status Driver Normal Selection State.....	51
Status Driver Selection	51
Automation Cycle Stop or End Of Weld	51
Switch Debounce Filter Time Delay	51
Timer Board Enable/Bypass	51
System Control Inputs	52
Card Slot and Jumper Block Locations	52

This page intentionally left blank

Rear Panel Layout

All of the connectors contained on the DPC II Plus and the optional modules are shown below in Figure 5–1. No generator will have all the modules shown. Specifically the Multi-Probe Controller and the Press Control Modules are mutually exclusive. The modules are shown here to indicate their installed locations and connector types.

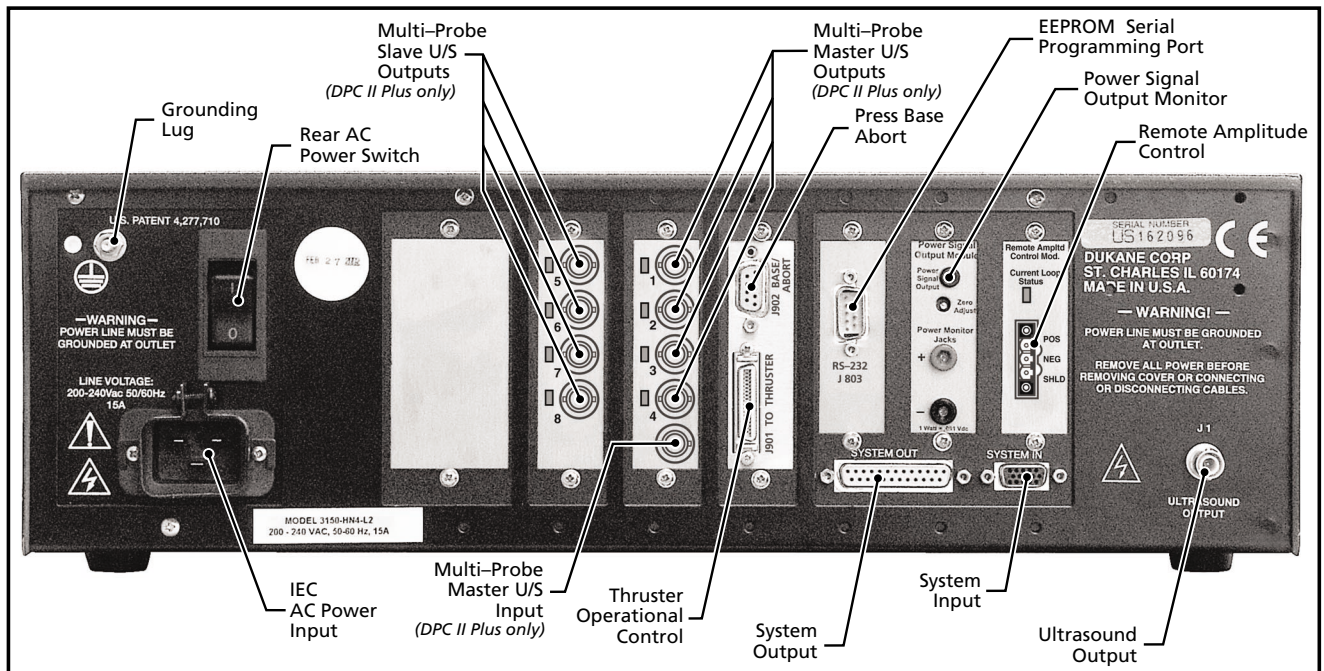

Figure 5–1 DPC II Plus and EZ Welder Rear Panel Connectors

System Input Connector

The System Input is a HD-15 (high-density, 15 contact) female connector. Pin assignments are shown in Figure 5–2. Table 5—I below lists the pinout and signal name for the System Input connector. A complete description of the input signals and their function is given on the next page. Users of custom automation will also find a list of wire color codes for the Dukane 200–1203 I/O cable assembly in Table 5—III. This cable is used to connect the DPC to custom automation equipment to control the welding process.

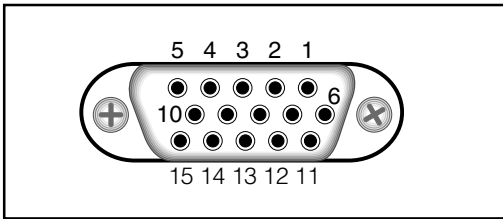

Figure 5–2 HD-15F System Input Connector

CAUTION

The System Input port uses the same type of connector as a standard computer video monitor port, but it is electrically very different. **DO NOT** connect any video monitor devices to this connector. Doing so may result in damage to both the video device and the DPC.

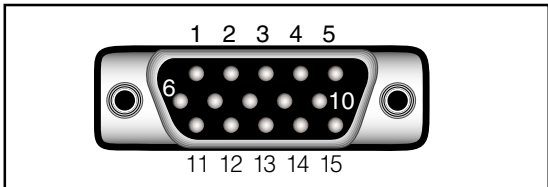

Figure 5–3 Cable end of SYSTEM IN connector.

Pin	Signal Name	Signal Description
1	+22VDC	Current limited to 250 mA maximum
2	Gnd	22VDC Return (DPC Chassis Ground)
3	Iso Oper In	Isolated Operate Input
4	Iso Common	Isolated Input Common (if jumper is selected – Figure 5–9/SH707)
5	Iso Press Cntrl	Isolated Press Control
6	Not Used	Spare Input Pin
7	Gnd	22VDC Return (DPC Chassis Ground)
8	Sw Oper Input	Switch Closure Operate Input
9	Iso Auto Stop	Isolated Automation Stop Input —OR— Isolated Automation End-Of-Weld (set by jumper SH704 see Figure 5–12)
10	Not Used	Reserved for Future Use
11	HPPI	Hand Probe Press Inhibit
12	Setup I.D. Bit 0	Remote Setup Selection Bit #0 (LSB)
13	Setup I.D. Bit 1	Remote Setup Selection Bit #1
14	Setup I.D. Bit 2	Remote Setup Selection Bit #2 (MSB)
15	F P Lock	Front Panel Control Lock

Table 5—I System Input Connector Signals

NOTE

The connector pinout in Figure 5–2 is the female DPC panel connector. The male cable end is a mirror image and is shown in Figure 5–3.

Pin 14	Pin 13	Pin 12	Timer Setup File	MPC Probe Selected
0	0	0	File 1	Probe 1
0	0	1	File 2	Probe 2
0	1	0	File 3	Probe 3
0	1	1	File 4	Probe 4
1	0	0	File 5	Probe 5
1	0	1	File 6	Probe 6
1	1	0	File 7	Probe 7
1	1	1	File 8	Probe 8

Note: 1 = Pin Grounded (to DPC chassis)
0 = Pin Open (no connection)

Table 5—II Remote Setup File Selection

Input Signal Description

Pin 1 (+22V)

This pin can supply +22VDC at up to 250mA to power the user's automation controls.

Pin 2 (Gnd)

Pin 2 and 7 are the 22VDC and Operate returns and are tied to the chassis ground.

Pin 3 (Isolated Operate In)

This pin is used to initiate the operate sequence. The factory default setting is a non-isolated sink requiring a dry contact closure to ground (pins 2 or 7). This input can be changed to a source or fully isolated input by jumper block SH707. See Figures 5–11, 5–12 and Appendix C.

Pin 4 (Isolated Common)

This pin is used as the isolated return common if jumper block SH707 is configured as a fully isolated input (position JU726). See Figures 5–11, 5–12 and Figure C-5.

Pin 5 (Isolated Press Control)

This input is designed to be used in conjunction with the optional Press Control Board. The signal is used to activate the thruster up and down. The factory default setting is a non-isolated sink requiring a dry contact closure to ground (pins 2 or 7). This input can be changed to a source or fully isolated input by jumper block SH707. See Figures 5–11, 5–12 and Appendix C.

Pin 6 (Not Used)

Isolated input reserved for future use.

Pin 7 (Gnd)

Pin 2 and 7 are the 22VDC and Operate returns and are tied to the chassis ground.

Pin 8 (Operate)

A dry contact closure (no voltage) between pin 8 and ground (pins 2 or 7) will initiate the operate sequence and is functionally the same as pin 3.

Pin 9 (Isolated Auto Stop)

This signal stops the operation sequence. The factory default setting is a non-isolated sink requiring a dry contact closure to ground (pins 2 or 7).

Pin	Color	Signal Desc	Note
1	Red	+22V	Red used by Belden may appear brown
2	Black	Gnd	Also connected to connector metal shell
3	Blue/Blk	Iso Oper In	
4	Green/Wht	Iso Common	
5	Blue/Wht	Iso Auto Cntrl	
6	Red/Blk	Reserved	Red used by Belden may appear brown
7	White/Blk	Gnd	
8	White	Sw Oper Input	
9	Orange	Iso Auto Stop	
10	Blue	Reserved	
11	Orange/Blk	Hand Probe Press Inhibit	Black may be faint – Don't confuse with 9
12	Red/Wht	Remote Setup Selection (LSB)	Red used by Belden may appear brown
13	Green/Blk	Remote Setup Selection	
14	Black/Wht	Remote Setup Selection (MSB)	
15	Green	F P Lock	

Table 5—III System Input Cable Color Code (P/N 200–1203)

This input can be changed to a source or fully isolated input by jumper block SH707. See Figures 5–11, 5–12 and Appendix C.

Pin 10 (Not Used)

Isolated input reserved for future use.

Pin 11 (Hand Probe Press Inhibit)

The adapter cable (P/N 200–1203) has pin 11 grounded to indicate a hand probe is connected.

Pins 12, 13, 14 (Remote Setup)

These pins are used to select one of eight setup files. When using the multi-probe controller module (MPC), these bits also select which probe is activated. A dry contact closure between pins 12, 13 or 14 and ground (pins 2 or 7) will activate one of the setup files. The pin combinations to select setup files 1 through 8 are given in Table 5—II. Note that file 1 is the default selection.

Pin 15 (F P Lock)

A dry contact closure between pin 15 and ground (pins 2 or 7) will lock out the front panel TEST key and prevent it from being activated. This also prevents any programming changes.

System Output Connector

The System Output panel connector is a DB-25 Female type. Pin numbers are shown in Figure 5–4 and pin assignments are given in Table 5—IV. Dukane cable assembly P/N 200–1302 is used to connect the DPC to custom automation equipment to monitor the welding process. A complete description of the signals and their function is given on the following pages.

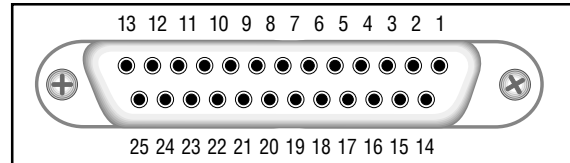

Figure 5–4 DB-25 System Output Connector

Pin	Signal Name	Signal Description
1	+22VDC	Current limited to 250 mA maximum
2	Gnd	22VDC Return (DPC Chassis Ground)
3	Gnd	Status Driver Output Ground (DPC Chassis Ground)
4	Stat Drv	Status Driver Output (1 amp maximum)
5	Not Used	Spare Output Pin
6	U/S Active	Ultrasound Status Output (Active Low)
7	Sys Fault	System Fault Output (Active Low)
8	O T Fault	Overtemperature Fault Output (Active Low)
9	O L Fault	Overload Fault Output (Active Low)
10	On Line	On Line Status Output (Active Low)
11	Gnd	Status Outputs Ground (DPC Chassis Ground)
12	Loop Fault	4–20 mA Current Loop Fault Output ¹ (Active Low)
13	Gnd	Monitor Outputs Ground (DPC Chassis Ground)
14	Freq Out	Frequency Monitor Output (31Vrms maximum)
15	Amp Out	Amplitude Monitor Output (10.0V = 100%)
16	Pwr Sig	Power Signal Monitor Output ² (1mV = 1 watt)
17	Pwr Reg Stat	Power Regulation Status Output ³ (Active Low)
18	MPC Ready	Multi–Probe Controller Ready ⁴ (Active Low)
19	Iso Pwr Fail	Isolated Power Fail Signal (Active Low)
20	Iso BSP	Isolated Bad/Suspect Part Output ⁵ (Active Low)
21	Iso GP	Isolated Good Part Output ⁵ (Active Low)
22	Iso RDY	Isolated Ready Signal (Active Low)
23	Iso ID	Isolated In–Dwell Signal (Active Low)
24	Iso Com	Isolated Outputs Common (Isolated Gnd)
25	Not Used	Spare Output Pin

Table 5—IV System Output Connector Signals

CAUTION

The System Output port uses the same type of connector as a standard RS-232, DB-25 serial interface, but it is electrically very different. **DO NOT** connect any RS-232 devices to this connector. Doing so may result in damage to both the serial device and to the DPC internal circuitry.

Output Signal Description

Pin 1 (+22V)

This pin can supply +22VDC to supply power for user automation controls. It is limited to 250mA.

Pin 2 (Gnd)

Pin 2 is the 22VDC and Status Out return. It is tied to the chassis ground.

Pin 3 (Gnd)

Pin 3 is the 22VDC and Status Out return. It is tied to the chassis ground.

Pin 4 (Status Driver)

An active low output on pin 4 indicates the condition set on Jumper Block SH702 has occurred (see Figures 4-7 and 4-8). The factory default is OVERLOAD.

Pin 5 (Not Used)

Pin 5 is reserved for future use.

Pin 6 (U/S Active)

An active low output on pin 6 indicates the ultrasound is being delivered to the probe.

Pin 7 (System Fault)

An active low output on pin 7 indicates the generator has detected an out of tolerance voltage fluctuation. The front panel status display will indicate FAULT.

Pin 8 (OVERTEMP)

An active low output on pin 8 indicates that one of the power modules in the generator has overheated and automatically shut down. The front panel status display will indicate OVERTEMP.

Pin 9 (OVERLOAD)

An active low output on pin 9 indicates that excessive power beyond the generators rated output is being drawn. The ultrasonic signal is shut down when an overload condition is detected. The front panel status display will indicate OVERLOAD. The overload signal resets when the operate input deactivates or the TEST switch is released.

NOTE

Active Low outputs are open collector Darlington transistors that sink current to ground (either chassis ground or isolated common @20mA maximum).

Custom automation users must supply their own pullups. See Appendix C for sample circuits.

Pin 10 (ON LINE)

An active low output on pin 10 indicates the generator is on line and is capable of being triggered externally. The front panel status display will indicate ON LINE.

Pin 11 (Gnd)

Pin 11 is the 22VDC and Status Out return. It is tied to the chassis ground.

Pin 12 (Current Loop Fault)¹

An active low output on pin 12 indicates the 4–20mA current loop output has a fault. This output is only available when a Remote Amplitude Control module is installed.

Pin 13 (Monitor Gnd)

Pin 13 provides a return path to the chassis ground for the monitor outputs on pins 14, 15 and 16.

Pin 14 (Freq Out)

The signal on pin 14 is the actual output frequency. It is a sine wave with an amplitude of 31 Vrms maximum.

Pin 15 (Amp Out)

The signal on pin 15 is proportional to the output signal amplitude. The scale is 10.0V = 100%. This allows automation equipment to monitor the DPC amplitude setting.

Pin 16 (Pwr Sig)²

This output is only available when the optional Power Signal Output module (part 438-826) is installed. The signal on pin 16 is proportional to the true RMS ultrasonic output power being drawn from the DPC. The scale is 1mV = 1Watt on the 20kHz, 30kHz and 40kHz models. The maximum full scale output is 4.095V (4,095 Watts). On the 50kHz and 70kHz models, the scale factor is 10mV = 1 Watt with a maximum scaled output of 409.5 Watts.

Pin 17 (Pwr Reg Status)³

This option is not currently available.

Pin 18 (MPC Ready)⁴

An active low output on pin 18 indicates the MPC module (Multi–Probe Controller) is ready and will accept probe selection changes on the Remote Setup inputs.

Pin 19 (Iso Power Fail)

An active low output indicates that AC power is within operating range. This output will turn off (high impedance state which no longer sinks current), if the AC power fails or is switched off.

Pin 20 (Iso Bad/Suspect Part)⁵

An active low output that indicates the weld cycle is outside the boundary limits set in the Bad Limits menu. This signal activates when the ultrasonic output is terminated at the end of the weld. The default setting is maintained which means the signal remains active until the beginning of the next cycle. If the Utilities menu option is set to momentary, the signal is pulsed for 100 msec.

Pin 21 (Iso Good Part)⁵

An active low output that indicates the weld cycle did not cross the boundary limits set in the Suspect or Bad Limits menu. This signal activates when the ultrasonic output is terminated at the end of the weld. The default setting is maintained which means the signal remains active until the beginning of the next cycle. If the Utilities menu option is set to momentary, the signal is pulsed for 100 msec.

Pin 22 (Iso Ready)

An active low output that occurs at the end of all portions of the weld cycle. The signal remains active until the beginning of the next cycle.

Pin 23 (Iso In–Dwell)

This output is active low while the ultrasonic output signal has been turned off during the HOLD time of the weld cycle.

Pin 24 (Iso Common)⁵

Pin 24 provides the return path for the isolated output signals on pins 19, 20, 21, 22 and 23.

Pin 25 (Not Used)

Pin 25 is reserved for future use.

FOOTNOTES

- 1 Requires a Remote Amplitude Control module.
- 2 Requires a Power Signal Output module.
- 3 Not presently available.
- 4 Requires a Multi–Probe Controller module.
- 5 Requires the standard DPC II Plus timer feature.

Remote Amplitude Control Module

Part No. 438-799

This optional module enables remote control of output amplitude of the DPC II Plus. The control interface is a 4–20mA current loop. The current loop connector and fault indicator are shown in Figure 5-5. The output can be adjusted from 36% to 100%. The scale factor is $\Delta 16\text{mA} = \Delta 64\%$ which is $\Delta 1\text{mA} = \Delta 4\%$. The graph of output as a function of loop current is shown in Figure 5-6. The input compliance is 10 volts minimum.

Failure to provide between 4mA and 20mA of loop current is detected as a fault and will not produce any output. The current loop fault indicator is a bi-color LED. It is green when the current is between 4 and 20mA and red when the current is below this value. The module contains an internal jumper block (SH1) to select the current loop fault option. The default setting (jumper JU1) disables ultrasonic output if a loop fault occurs. The setting can be reversed with JU2 to enable the minimum level output (36%) if a loop fault occurs. This is used primarily for system testing when a current loop is unavailable.

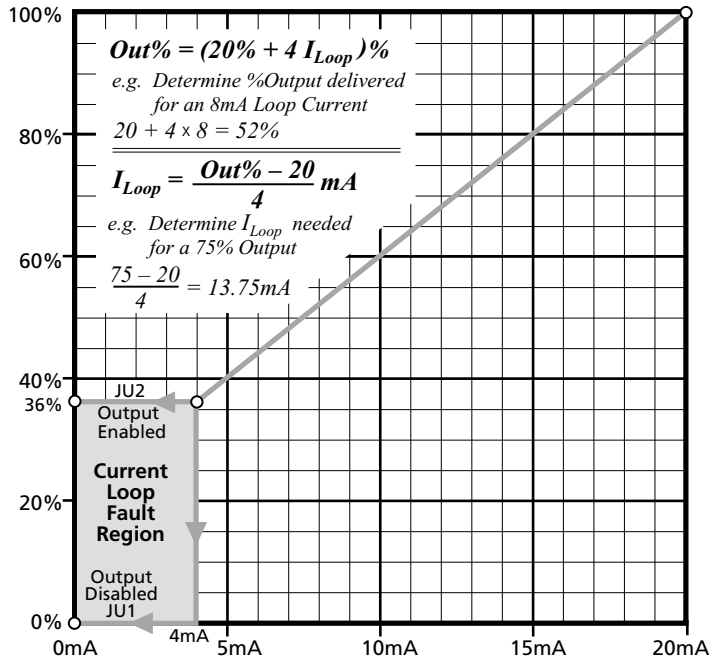

Figure 5-6 Current Loop Transfer Function Graph

NOTE

The equations for **Out%** and **I_{Loop}** are only valid for normal operating conditions —
 $36\% \leq \text{Out}\% \leq 100\%$ and
 $4\text{mA} < I_{\text{Loop}} \leq 20\text{mA}$

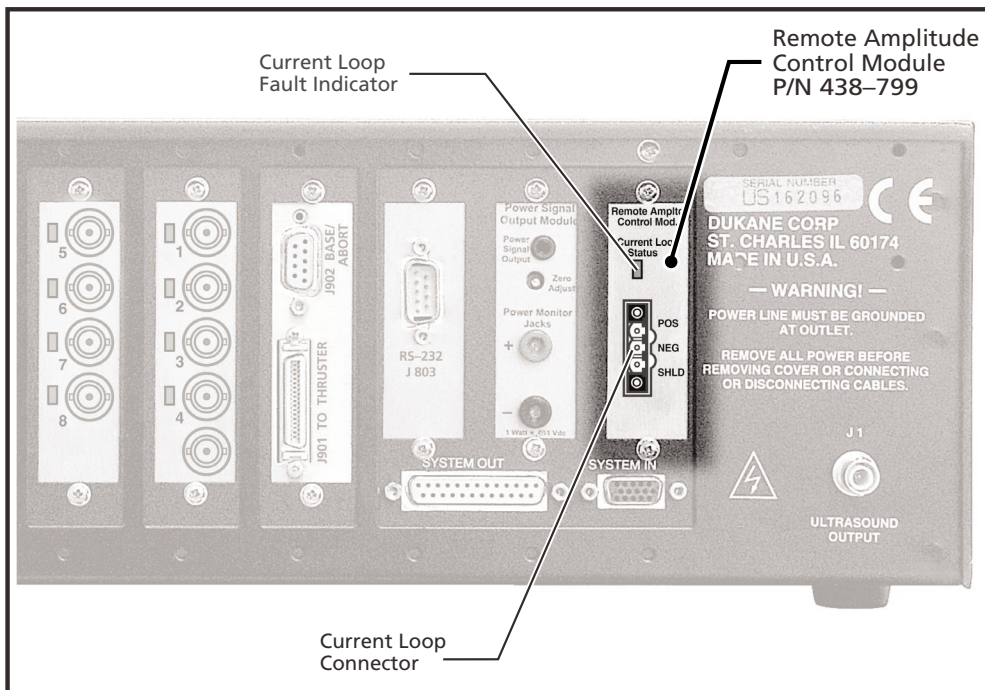

Figure 5-5 Remote Amplitude Control Module

NOTE

If you have a Remote Amplitude Control module installed, its setting will override any front panel setting. The front panel menu will accept the value, but the output amplitude will be determined by the 4–20mA loop current.

Power Signal Output Module

Part No. 438–826

This optional module enables the DPC II Plus to operate in the Weld-By-Energy mode. When installed, the DPC II Plus automatically detects the board and enables the energy options in the process control menu. The module also permits the user to monitor the True-RMS ultrasonic output power from the DPC II Plus. The module is shown in Figure 5–7. The output signal can be monitored from three different connectors simultaneously. The scale factor is the same on all three outputs. On the 20kHz, 30kHz and 40kHz models, it is $1\text{mV} = 1\text{ Watt}$ and the maximum full scale output is 4,095 Watts. On the 50kHz and 70kHz models, the scale factor is $10\text{mV} = 1\text{ Watt}$ with a maximum output of 409 Watts.

1. A miniature phone jack is provided on the top of the rear panel.
2. A pair of test jacks on the rear panel allow a hand-held multimeter to monitor the power.

3. The power output signal can also be monitored by automation equipment using the System Output connector by measuring between pin 16 (Power Signal) and pin 13 (Monitor Ground Reference).
4. This module also features an offset adjustment to set the output to zero. Only adjust the offset after the DPC system has been powered up for at least 15 minutes and with the ultrasound output deactivated.

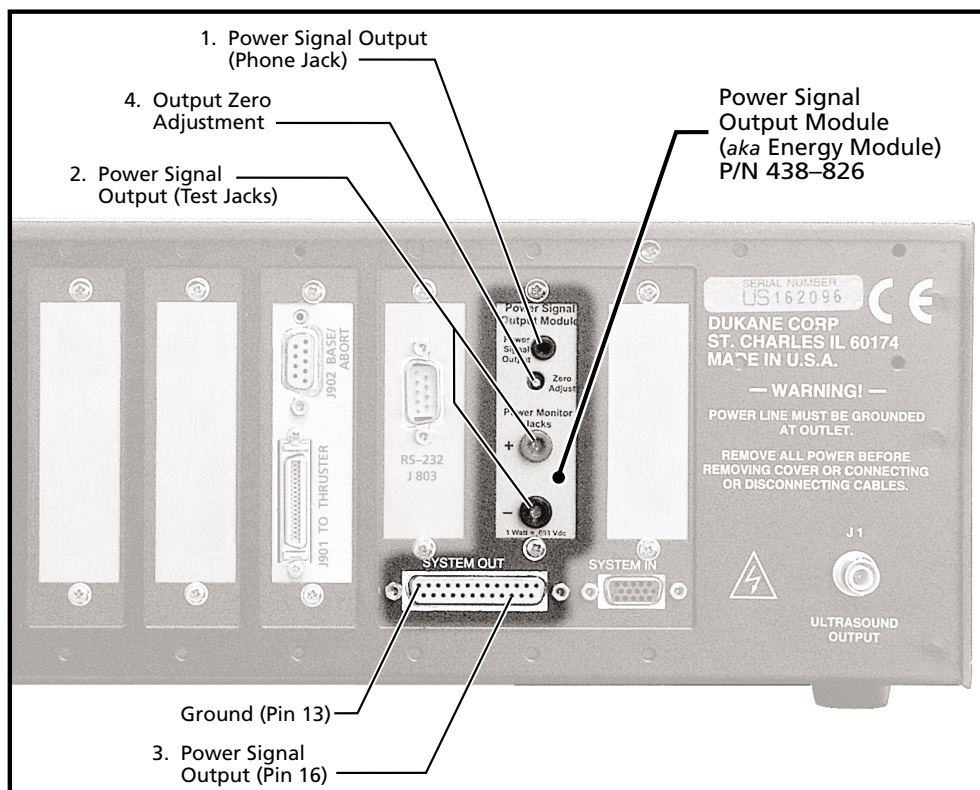

Figure 5–7 Power Signal Output Module

Press Control Module

Part No. 110–3938

This optional module enables the DPC II Plus to control a Dukane Model 210, 220 or 410 press or custom automation. This module is also installed on a EZ Welder™ System. The module is illustrated in Figure 5–8. The cabling hookup to a Dukane press system is shown in Figure 3–8.

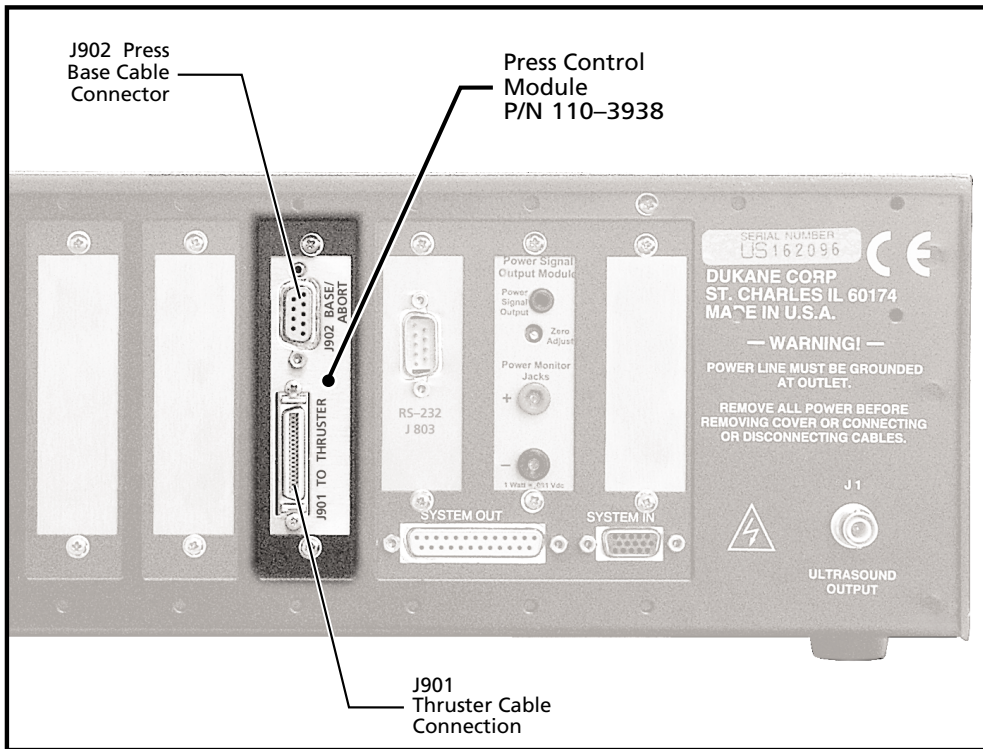

Figure 5–8 Press Control Module

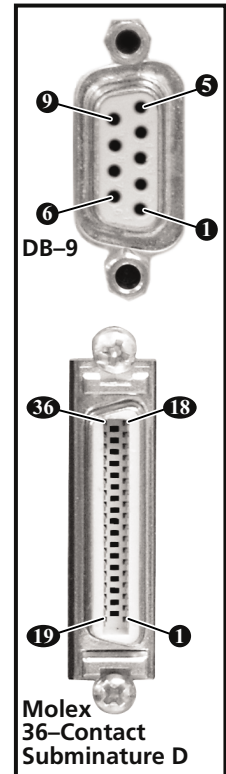

Figure 5–9 Press Connector Pin Identification

Pin No.	Type	Function	Signal Description
1	Input	Activation Switch 1	Normally Open (N.O.) dry contact closure to ground
2	Input	Activation Switch 2	Normally Open (N.O.) dry contact closure to ground
3	Input	Hardware Abort Power In	Normally Closed (N.C.) emergency switch contact
4	Input	Software Abort	Normally Open (N.O.) dry contact closure to ground
5	Ground	Internal Ground	Internal Ground (Gnd)
6	Ground	Internal Ground	Internal Ground (Gnd)
7	Ground	Internal Ground	Internal Ground (Gnd)
8	Input	Automation Input	Normally Open (N.O.) dry contact closure to ground
9	+22V DC	Hardware Abort Power Out	Normally Closed (N.C.) emergency switch contact

Table 5—V J902 Press Base Connector Pinout

Table 5—V on the previous page lists the pinout and signal description for J902 which is the Press Base connection. Note that there is an automation input on pin 8 which is electrically identical to pin 8 on the System Input connector. This permits you to use J902 to initiate operation without having to run a separate connection to pin 8 of the System Input connector. Figure 5–9 on the previous page, identifies the pin numbers for both J902 and J901.

NOTE

J902 Press Base connector has multiple ground pins. The DPC–2 Plus/EZ uses pins 5, 6 & 7 for Ground. The DPC–3 uses pins 5 & 7 for Ground. The DPC–4 uses pins 6 & 7 for Ground.

To keep your custom automation circuits compatible with DPC models, only use pin 7 for a ground connection to the Press Base connector. It should be pointed out however, that the DPC–3 does have an Automation Input on pin 8.

Table 5—VI below gives the pinout and signal description for J901 which is the 36–pin Thruster connector. This connector is the same type as found on the DPC–III and DPC–IV. The cable specified is Part No. 200–1104 which is interchangeable with both DPC–III and DPC–IV generators.

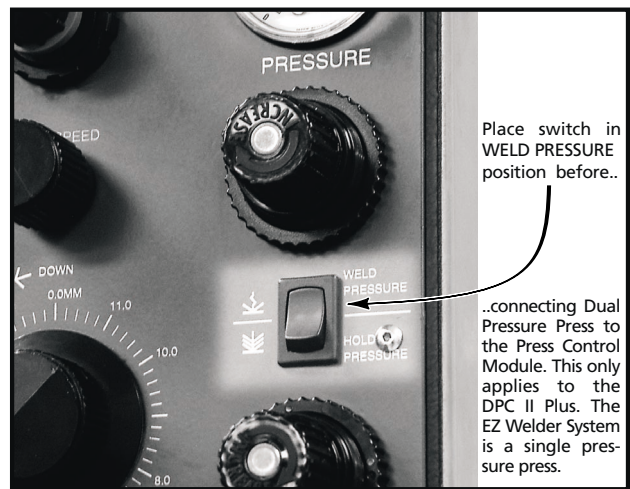

Pin No.	Input/Output	Function	Signal Type
1	Output	Dual Pressure Valve	Low side Mosfet driver to ground
2	Output	Trigger LED (-)	Low side Mosfet driver to ground
3	Output	Up Valve	Low side Mosfet driver to ground
5	Output	Down Valve	Low side Mosfet driver to ground
13	Input	Dual Pressure Switch	Normally–Open dry contact switch closure to ground
14	Input	Ground Detect	Normally–Open dry contact switch closure to ground
15	Input	Trigger Switch	Normally–Open dry contact switch closure to ground
16	Input	End Of Weld Switch	Normally–Open dry contact switch closure to ground
17	Input	Pre–trigger Switch	Normally–Open dry contact switch closure to ground
4, 19, 20, 22, 24, 26	Power	+22V Press	Internal Power to Press
6, 8, 10, 12, 25, 27, 28, 29, 30, 31, 32,34, 36	Ground	+22V Return	Power and Signal Ground
7, 9, 11, 18, 21, 23, 33, 35	Unused	Unused	Unused

Table 5—VI J901 Thruster Connector Pinout

Multi-Probe Master Module

Part No. 110-3954

This optional module enables the DPC II Plus to activate any one of four ultrasonic probes. Each probe can have its own setup file which is selected by the Setup ID# (pins 12, 13 & 14) of the HD-15 System Input connector. The functions are listed in Table 5-I and 5-II. Rear panel bicolor LED status indicators for each probe output illuminate green when the probe channel is selected and red when the U/S is active. Both a MPC Master and Slave module are shown below in Figure 5-10.

Internal logic prevents more than one probe from being activated at a time or probe switching signals when the U/S is on. A ring-down circuit permits switching only when U/S output is zero. Internal fault logic senses any malfunction and deactivates the MPC Ready output.

The Multi-Probe Controller cannot be used with a press module. The master module has an extra wide back panel to prevent it’s accidental use with the press module.

Multi-Probe Slave Module

Part No. 110-3956

This optional module adds four additional probe selection channels to the DPC II Plus. This gives a total of eight probe channels. The slave module cannot be used alone. It must be used with the master module. An internal connector supplies the ultrasound signal from the Master module. As with the Master module, each output channel has a bicolor LED status indicator that illuminates green when the probe channel is selected and red when the U/S is active.

NOTE

The Ultrasound input on the MPC Master must be connected to the DPC Ultrasound output connector (J1) with a RG62B/U coax. This is indicated as Cable 2 in Figure 3-6.

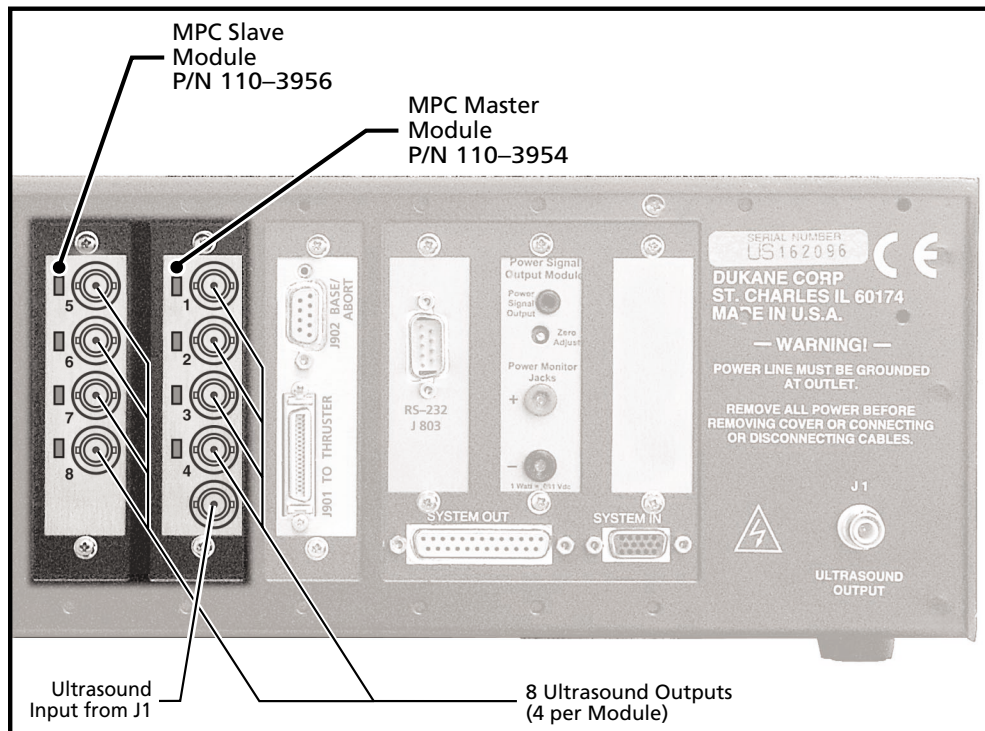

Figure 5-10 Master and Slave Multi-Probe Controller (MPC) modules

Jumper Block Options

The DPC II Plus may be customized to your specific requirements by means of internal jumpers located on the main printed circuit board. Below is a list of the jumper blocks, their default factory settings and their alternate positions. Figures 5–11 and 5–12 on the following pages show the location of the jumper blocks in more detail. The factory default setting is indicated by a diamond ◊ next to the description in Figure 5–12.

Status Driver Normal State Selection

Jumper Block – SH701 (Pin 4 output on DB-25)

JU701 - Normally OFF (Factory Default)

JU702 - Normally ON

Status Driver Selection

Jumper Block – SH702 (Pin 4 output on DB-25)

JU703 - Ultrasound Active Status

JU704 - Overload Fault (Factory Default)

JU705 - Over temperature Fault

JU706 - System Fault

JU707 - Any Fault

Automation Cycle Stop or End Of Weld Selection

Jumper Block – SH704

JU713 - Normally OFF (Factory Default) – Use depends upon custom automation configuration

JU714 - Normally ON

JU715 - Automation Stop Fault – Move jumper to this position to use Auto Stop (Figure 7–13)

JU716 - Automation End of Weld (Factory Default)

Switch Debounce Filter Time Delay Selection

Jumper Block – SH705

JU717 - No Time Delay (used for electronic switches)

JU718 - 1 msec

JU719 - 10 msec (Factory Default)

JU720 - 22 msec

Timer Board Enable/Bypass

Jumper Block – SH706

JU723 - Timer Board Enable (normally selected for a DPC II Plus)

JU722 - Timer Board Bypass (Factory Default – used for standard DPC II)

System Control Inputs Jumper Block – SH707

- JU724 - Non-Isolated Sink (Factory Default) – Dry contact between input and DPC ground.
- JU725 - Non-Isolated Source – Dry contact between input and +22 VDC.
- JU726 - Isolated Source – Input can be either sinking or sourcing. A signal of 5 to 24 VDC is required at the isolated inputs. The current is internally limited to 12.5mA.

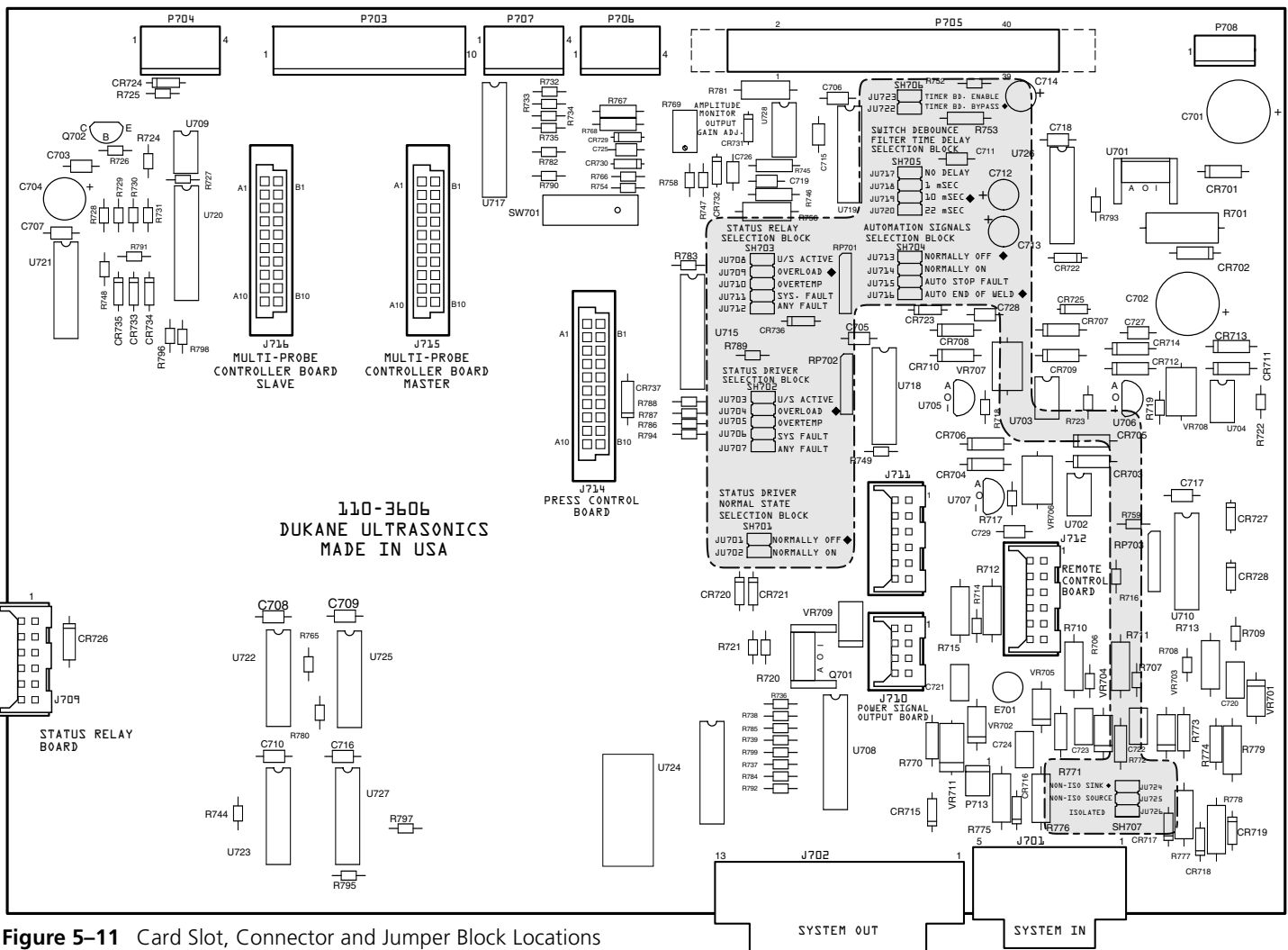

Figure 5-11 Card Slot, Connector and Jumper Block Locations

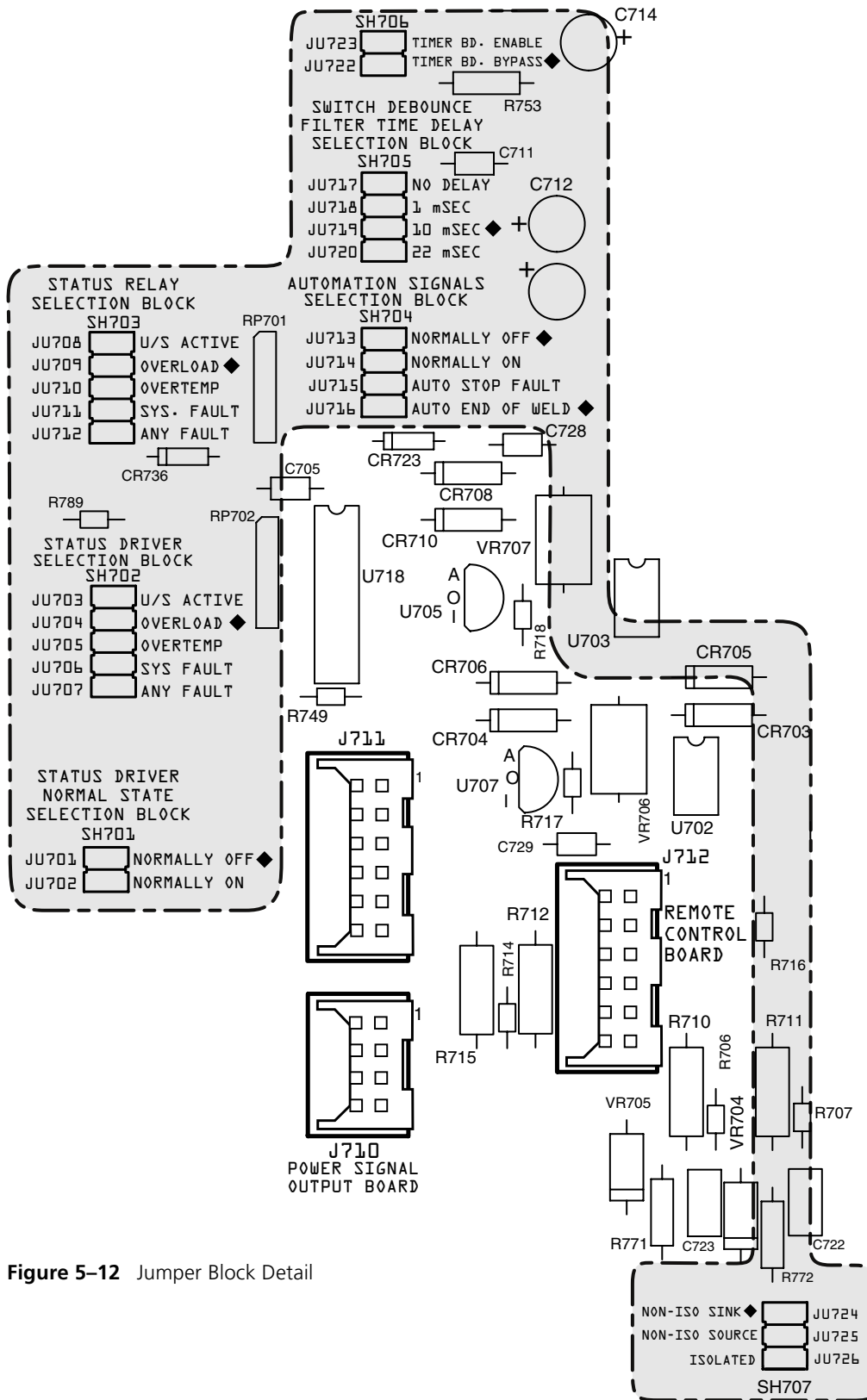

Figure 5-12 Jumper Block Detail

This page intentionally left blank

Menu Structure

- Process Setup
- Process Control
- Process Limits
- Utilities

Process Setup	57
Process Control	58
Process Limits	60
Utilities	61

This page intentionally left blank

Process Setup Menu

This section deals with the overall menu structure. Each setup menu is later discussed in detail in its own section. Each time the DPC II Plus is powered up, the processor scans the system to determine which modules are installed and if a hand probe is connected. It first displays which version of the DPC firmware is installed as shown in Figure 6–1.

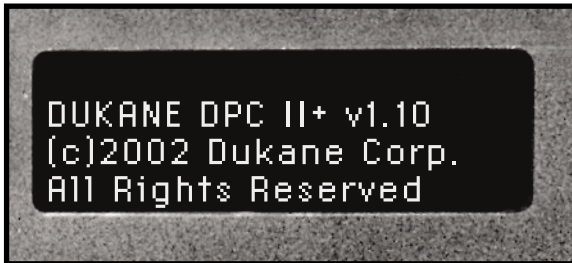

Figure 6–1 DPC II Plus Startup Menu

After a few seconds, the screen displays the welding mode and installed modules. Depending upon your configuration, your screen may display HAND PROBE DETECTED, AUTO PROBE DETECTED, MPC PROBE DETECTED, ECONOMY PRESS DETECTED, or PRESS BOARD DETECTED. This is shown in Figure 6–2.



Figure 6–2 DPC II Plus Configuration Menu

Then the screen then displays the operate page which contains the measured values from the last weld cycle as shown in Figure 6–3. If the Parts Counter (covered in detail in Section 9 –Utilities) is active, the count is displayed in the upper left-hand corner in place of the dashes (-----). The # sign and the digit after the dashes indicate which setup file is active. There are eight setup files available. Setup files are covered in Select Setup of Section 9 – Utilities Menu.

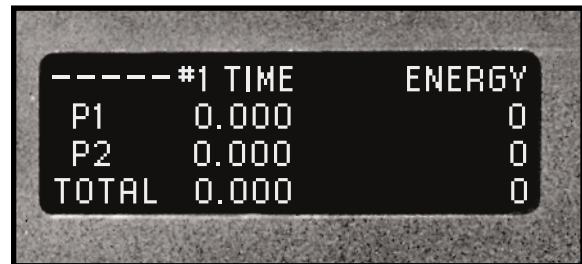

Figure 6–3 DPC II Plus Weld Cycle Display

Press the MODE key once to switch from the Operate mode to the Setup mode and display the Process Setup menu shown below in Figure 6–4.

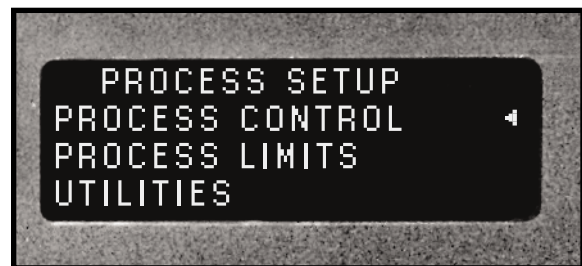

Figure 6–4 DPC II Plus Process Setup Menu

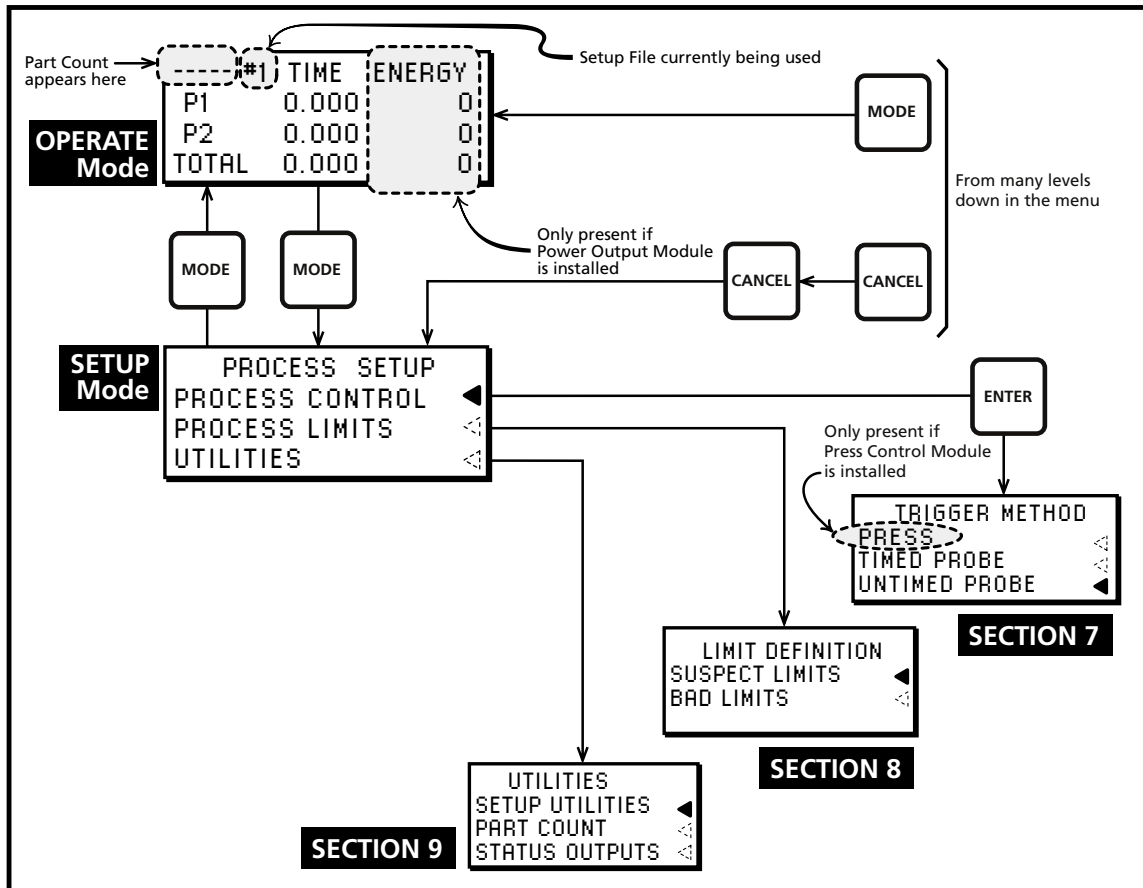

Figure 6–5 Process Setup Main Menu Structure

The main structure of the Process Setup menu is shown in Figure 6–5. You can press the MODE key or the CANCEL key twice at any time to return to the Process Setup menu. The MODE key toggles between the Weld Cycle data (Operate mode) and Process Setup menu (Setup mode) each time it is pressed. Process Setup is the root menu to select all subsequent sub menus. The Press menu option is only present if a Press Control Module is installed. The energy value is only displayed if a Power Output module is installed. The Process Control menu sets the welding parameters. Limit Definition menu sets the bounds for suspect parts and bad parts. Utilities menu enables you to save, copy and erase setup files, count parts which are out of limit and configure status outputs.

Process Control Menu

By pressing the up–arrow and down–arrow keys you can navigate the triangle pointer to select the

Process Control, Limit Definition or Utilities menu. Press the ENTER key to activate the selected menu. The Process Control Menu selects the trigger method, the welding mode and sets the values for the welding parameters. This menu’s structure is the most complex of the three. However, since the DPC II Plus reconfigures the user interface to be consistent with the installed modules, only the relevant portion of the menu structure is displayed. The flow chart for the Process Control menu is shown in Figure 6–6. The menu structure builds logically upon itself starting with the Hand Probe on the right side and progressing with more options towards the Press menu on the left. Process Control is discussed in detail in Section 7.

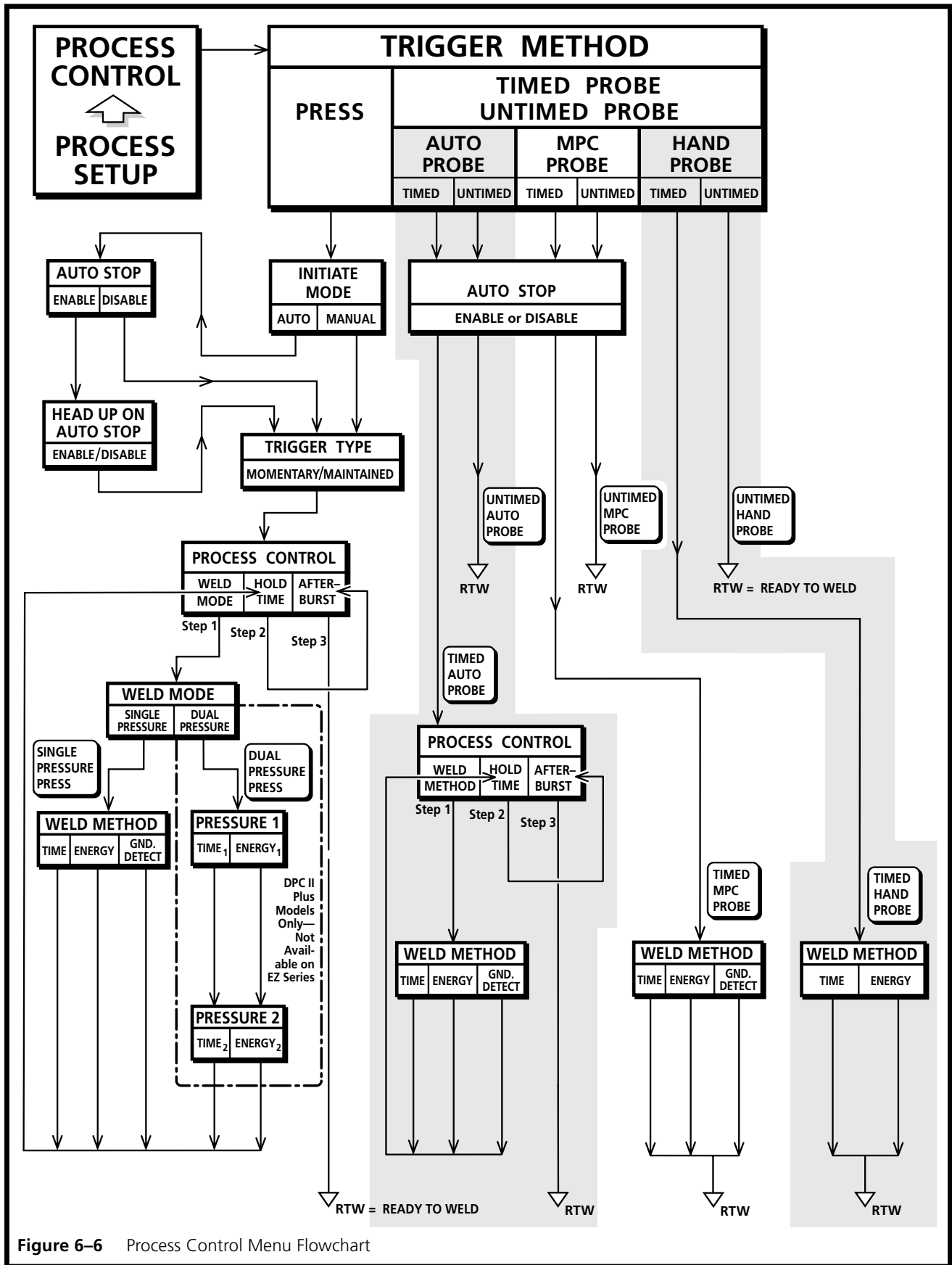

Figure 6-6 Process Control Menu Flowchart

Limit Definition Menu

The Limit Definition menu has two classes of settings. The first class is the suspect limits and the second class is for bad part limits. When applicable, choices for time, energy, total time and total energy are available. A simplified flow chart for the Limit Definition menu is shown in Figure 6–7. Although not indicated in this drawing, both upper and lower bounds can be set for each limit. The Limit Definition menu is covered in greater detail in Section 8.

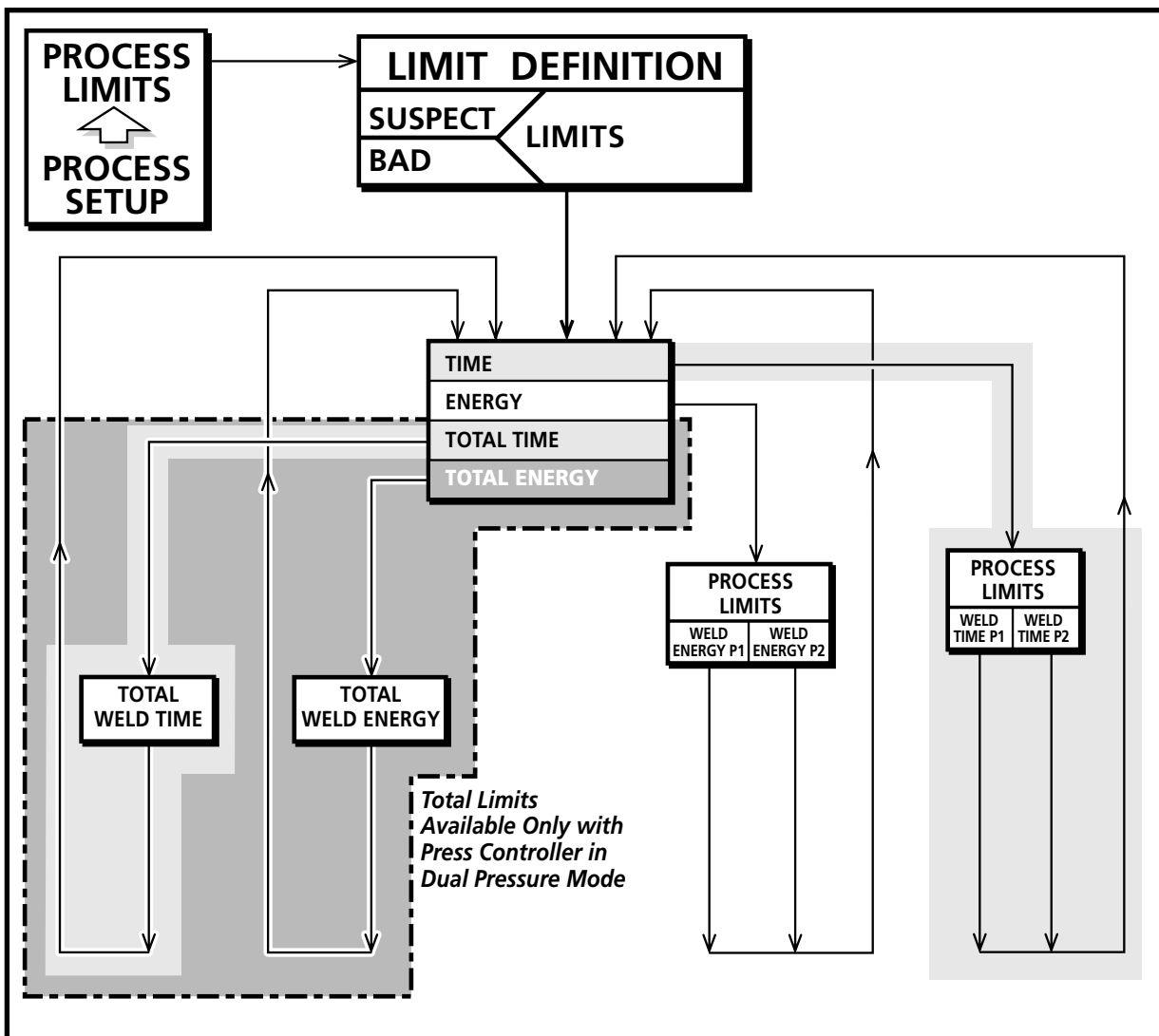

Figure 6–7 Limit Definition Menu Flowchart

Utilities Menu

The Utilities menu has four different sections. The first section handles setup file operations. The second section accesses the parts count functions. The third section configures the status output. The fourth section allows the operator to cycle the press off line. A simplified flow chart for the Utilities menu is shown in Figure 6–8 and is covered in greater detail in Section 9.

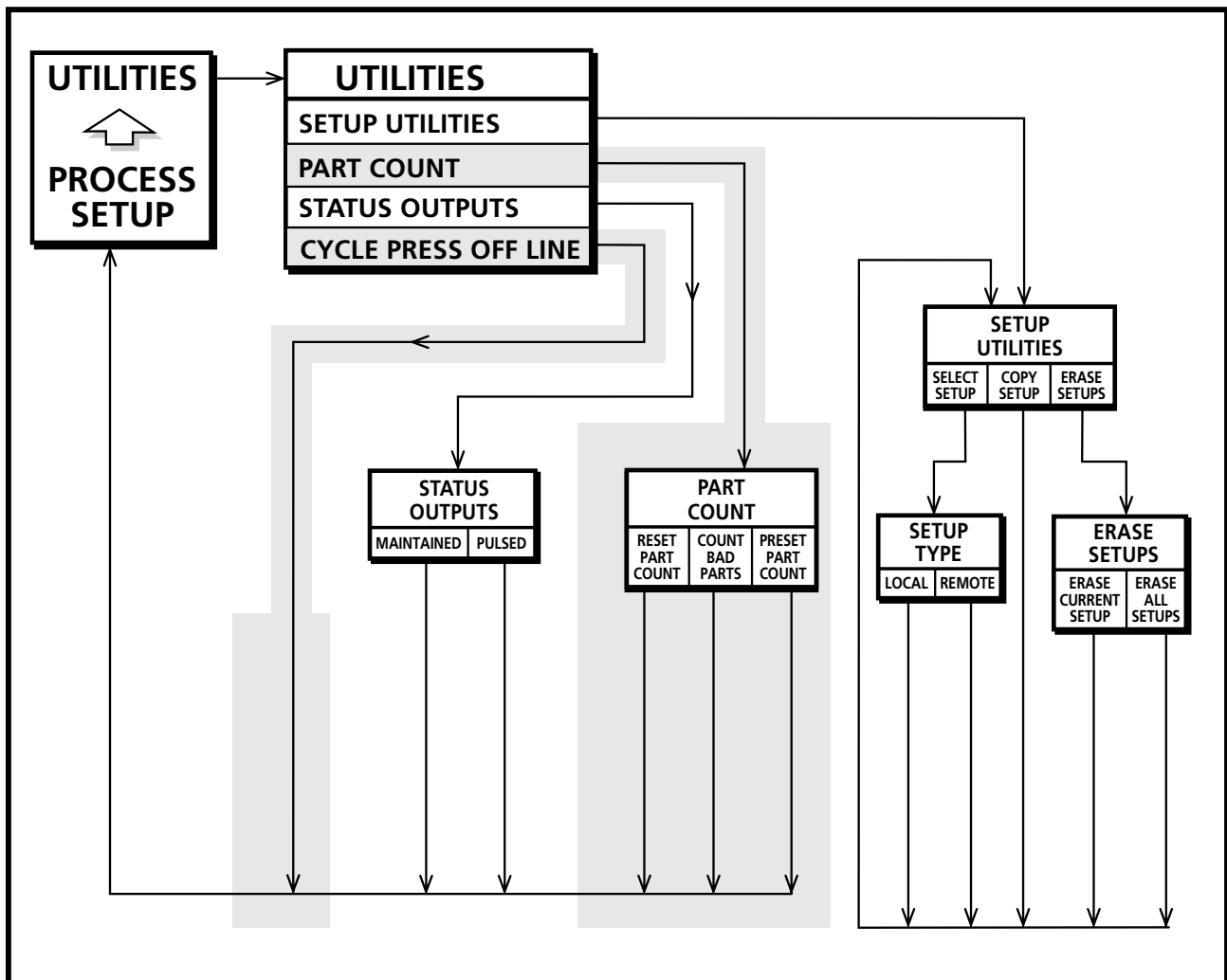

Figure 6–8 Utilities Menu Flowchart

This page intentionally left blank

Process Control Menu

- Hand Probe
- MPC Probe
- Auto Probe
- Press Mode
- Hot Keys

Hand Probe	65
Untimed Hand Probe	66
Timed Hand Probe	66
Timed Hand Probe – Energy	67
MPC Probe	68
Auto Stop Option	68
Untimed MPC Probe – Probe Delay	68
Weld Method – Time	69
Weld Method – Energy	70
Weld Method – Ground Detect	70
Auto Probe	71
Auto Stop Option	72
Untimed Auto Probe – Delay	73
Timed Auto Probe – Weld Method	73
HoldTime	73
Afterburst	73
Press Mode	75
Initiate Mode	76
Auto Stop	76
Head Up On Auto Stop	76
Trigger Type	76
Single/Dual Pressure Mode	76
Press Mode Example	77
Hot Keys	81
Process Control Recap	82

This page intentionally left blank

Process Control Menu

The Process Control Menu has a dynamic structure. Its configuration is determined each time the DPC II Plus is turned on. The processor scans for installed modules and connected probes and configures the user interface to match the installed hardware. This is another reason the AC power must be turned off before any modules or probes are installed or removed. If you are using a hand probe, make sure you have the latest version of the hand-probe adapter cable (P/N 200-1248). This has pin 11 (Hand Probe Detect) of the male HD-15 cable connector grounded.

Hand Probe

Make sure you have connected the hand probe as indicated in Figure 3-4. When the DPC II Plus is powered up, it displays the current version of the firmware and then indicates the current configuration. This is shown in Figures 7-1 and 7-2. The screen then displays the measured values from the last weld cycle as shown in Figure 7-3. If a Power Output module is installed, the menu will also display the energy data as in Figure 7-4.

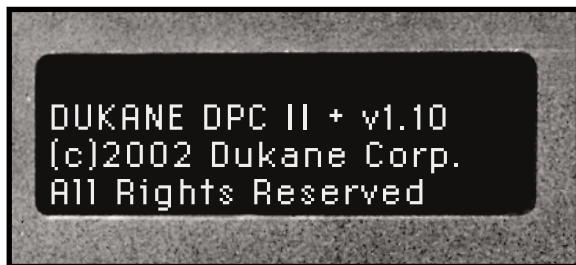

Figure 7-1 DPC II Plus Startup Menu

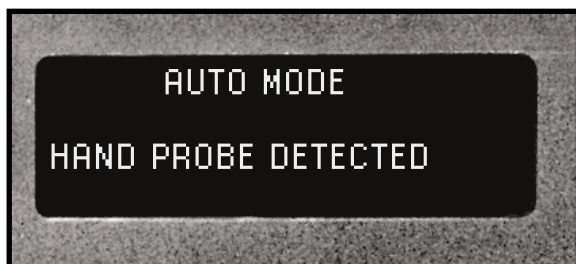

Figure 7-2 DPC II Plus Configuration Menu

CAUTION

Make sure electrical power is OFF before connecting/disconnecting cables or installing/removing modules from the DPC II Plus. Make sure **BOTH** the front and rear panel AC power breaker switches are in the OFF position. Failure to turn off the power may result in damage to the DPC and/or the modules. The DPC must also be properly grounded, as discussed in Section 3, to prevent any static discharge damage.

TIP

We highly recommend that you read this chapter completely. Even though some of the configurations may not be applicable to your process, the options and menu selections are covered in a sequential fashion. If you jump directly to the menu structure of interest, you will miss some of the preliminary topics.

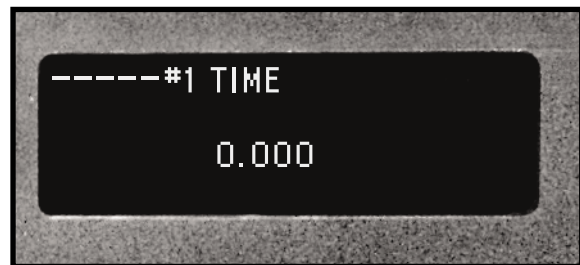

Figure 7-3 DPC II Plus Time Weld Cycle Display

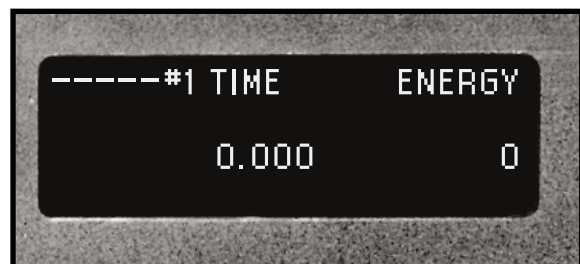

Figure 7-4 DPC II Plus Energy Weld Cycle Display

Press the MODE key to display the Process Setup menu. In Process Setup, the cursor should be pointing to Process Control as shown in Figure 7-5. If it is not, press the up-arrow and down-arrow key to navigate the triangle pointer to select Process Control. Press the ENTER key to activate the selected menu.

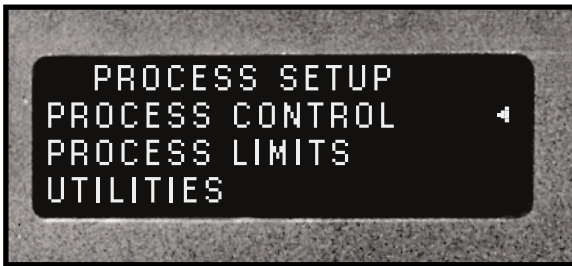

Figure 7-5 Process Setup Menu

Since the DPC II Plus reconfigures the user interface to be consistent with the installed modules, only the portion of the menu structure relating to hand probe operation is displayed. The only option for the Process Control screen is the Trigger Method which is shown in Figure 7-6.

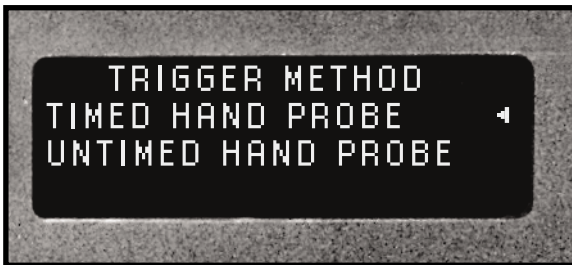

Figure 7-6 Process Control Trigger Method Menu

The flow chart for the Process Control menu with a hand probe connected is shown in Figure 7-7. If you do not have a Power Output module installed, the Energy Weld Method will not be displayed.

Untimed Hand Probe

Untimed Hand Probe operation has no parameters to enter. The generator is triggered whenever the hand probe trigger is engaged and continues until the trigger is released. Press ENTER and you are ready to weld (RTW).

Timed Hand Probe

In Timed Hand Probe mode, the welding stops whenever the trigger is released or the specified weld time

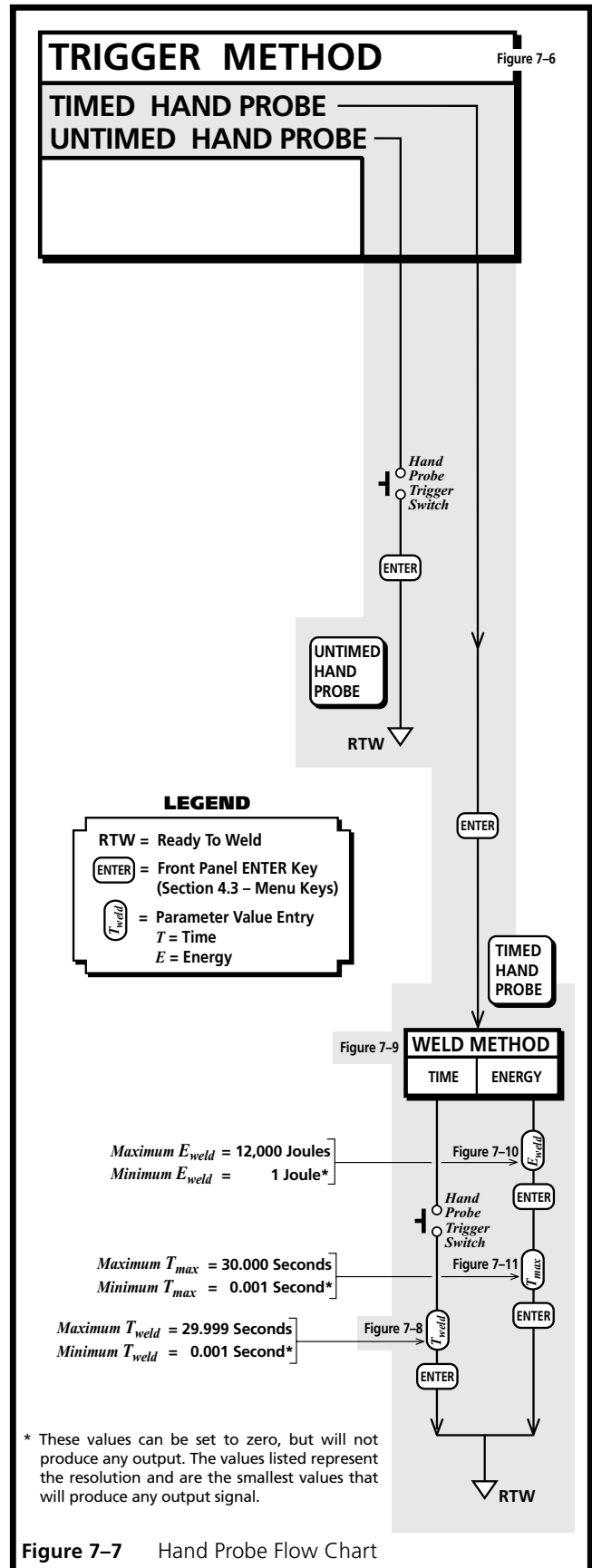

Figure 7-7 Hand Probe Flow Chart

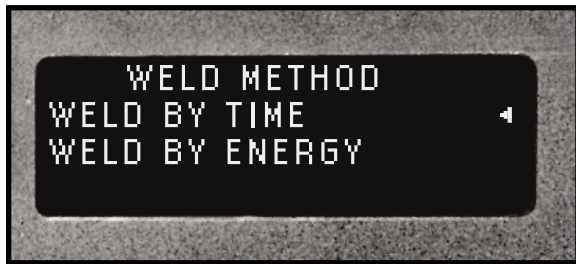

Figure 7-8 Hand Probe Weld Method

is reached, whichever comes first. Press ENTER and the data entry screen appears as shown in Figure 7-9. If a Power Output module is installed, then a Weld Method screen shown in Figure 7-8 is displayed first. Press the ENTER key to display the weld time data entry. If a Power Output module is not installed, there is only one choice and the Weld Method screen is bypassed. Timed Hand Probe operation requires the weld time to be entered. Use the Left and Right arrow keys to move to the desired digit position and the Up and Down arrow keys to increment or decrement the value. When the desired value is displayed, press ENTER for the next menu until all the required values have been entered.

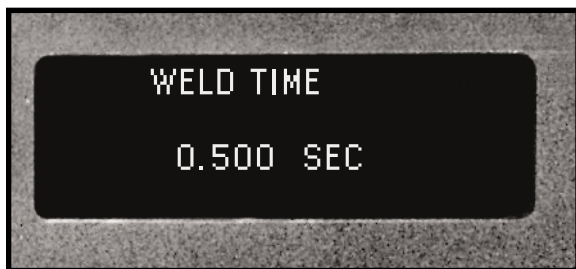

Figure 7-9 Hand Probe Weld Time

Timed Hand Probe – Energy

If a Power Output module is installed, you can also choose the Weld By Energy method. From the Weld Method screen shown in Figure 7-8, move the cursor down so it points to Weld By Energy and press the ENTER key.

To weld using the Energy Method, you first enter the desired welding energy. This data entry screen is shown in Figure 7-10. Enter the desired welding energy and press ENTER. Now enter the maximum weld time as shown in Figures 7-11. Press ENTER to complete the process. You will return to the Process Setup menu (Figure 7-5).

NOTE

The flowchart beginning with powerup to the Process Setup menu (Figure 7-5) and the Trigger Method screen (Figure 7-6) is shown in Figure 6-5. A portion of the drawing is repeated here.

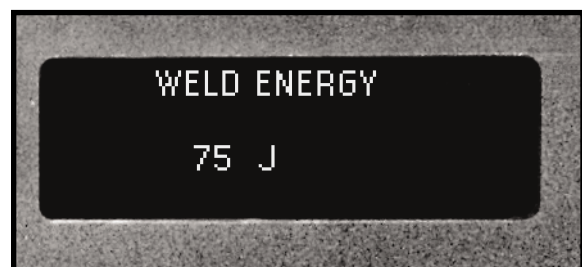
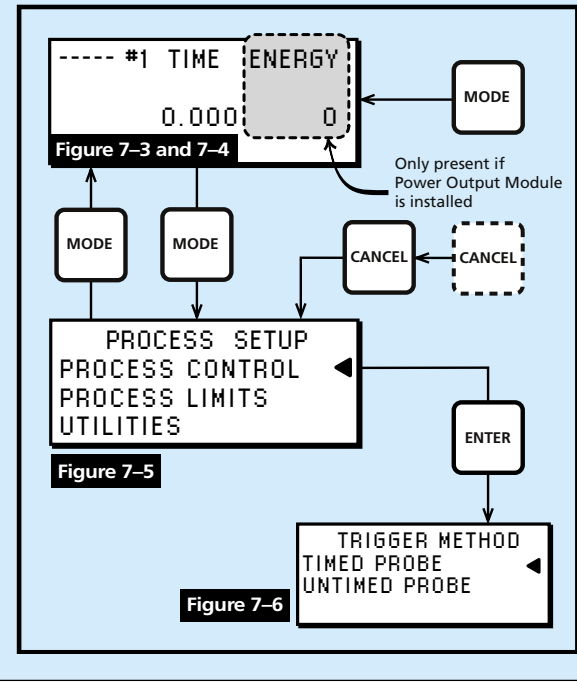

Figure 7-10 Hand Probe Weld Energy



Figure 7-11 Hand Probe Max Weld Time

MPC Probe

The cable connection diagram for connecting the Multi–Probe Controller module is shown in Section 3 in Figure 3–6. The flow chart for the Process Control menu with a Multi–Probe Controller installed is shown in Figure 7–12. If you do not have a Power Output module installed, the Energy Weld Method menu will not be displayed.

The Multi–Probe Controller (MPC) flow chart adds three options to the basic Hand Probe flow chart shown in Figure 7–7.

1. An **AUTO STOP** option is included which can be enabled or disabled.
2. A delay time value (T_{delay}) can be entered for untimed operation.
3. A weld method called **GROUND DETECT** is now available. This method requires values to be entered for the maximum weld time (T_{max}) and for a parameter called scrub time (T_{scrub}).

AUTO* STOP Option

This menu is shown in Figure 7–13. To use this option, move the SH704 jumper block to JU715 (see Figure 5–12). Use the down arrow key to select **ENABLE** and press **ENTER** to continue.

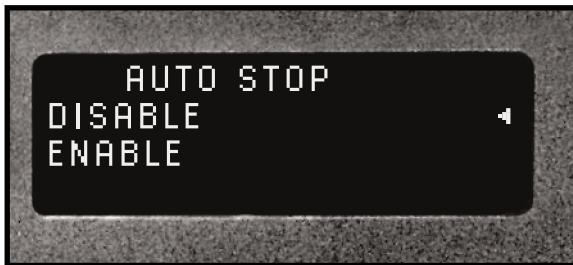

Figure 7–13 MPC Probe Auto Stop Mode Menu

When Auto Stop is enabled, a signal on pin 9 of the HD–15 SYSTEM IN connector will be recognized. This permits external automation equipment to stop the welding cycle. If Auto Stop is set to disable, then the signal will be ignored. If the SH704 jumper block is left in the End–Of–Weld factory default position (JU716), only the welding is stopped. Any programmed Hold or Afterburst (discussed later) will still be executed regardless of the Auto Stop mode.

* AUTO refers to Automation not automatic

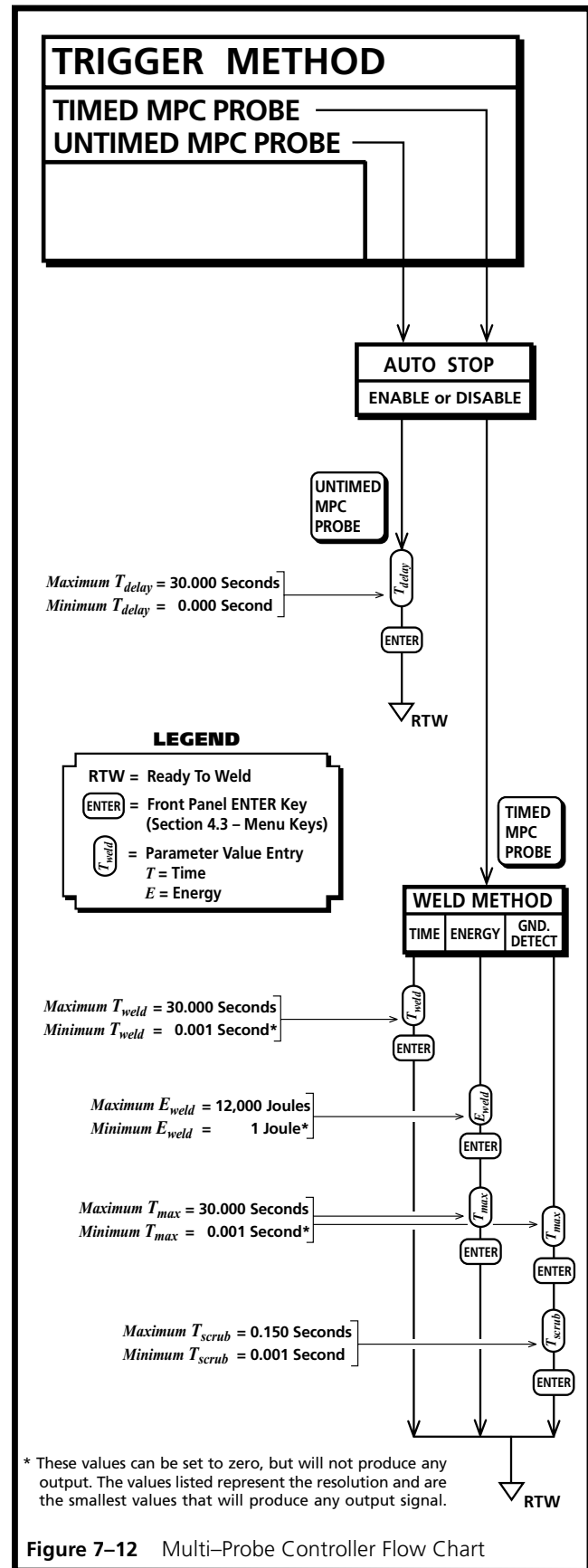

Figure 7–12 Multi–Probe Controller Flow Chart

Untimed MPC Probe – Probe Delay

The probe delay time value for untimed operation is shown in Figure 7–14. This parameter is typically used in a single auto probe configuration which is covered later in this section. For MPC untimed operation, the suggested value for the delay time is 0.000 second.

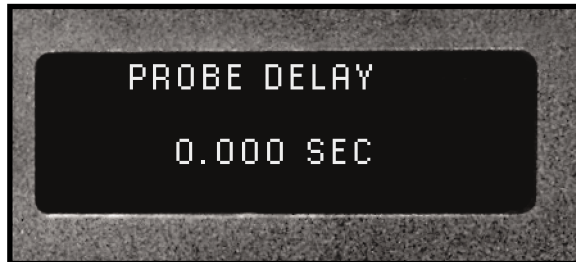

Figure 7–14 MPC Probe Time Delay

Weld Method – Time

For the Time welding method, an ultrasonic signal is generated for a specific time once triggered. After the AUTO STOP menu, the WELD METHOD menu is displayed. This is shown in Figure 7–15.

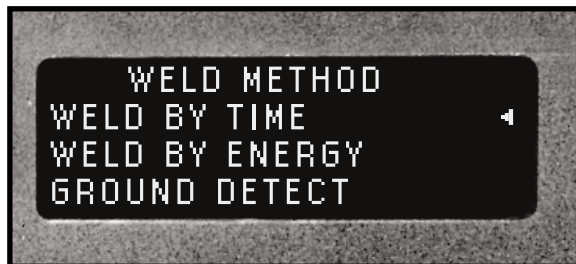

Figure 7–15 MPC Probe Weld Method Selection Menu

To weld by time, select WELD BY TIME using the Up and Down arrow keys and press the ENTER key. The weld time data entry screen appears as shown in Figure 7–16.

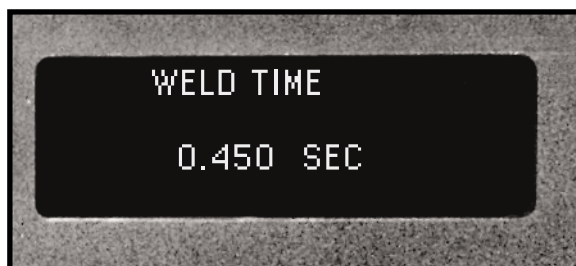
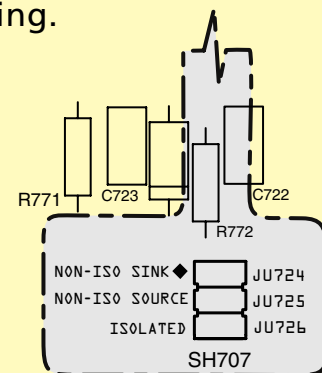

Figure 7–16 MPC Probe Weld Time

CAUTION



If the AUTO STOP option is set to ENABLE, you must supply the Isolated Automation Stop input signal to pin 9 of the HD-15 SYSTEM INPUT connector (see Table 5–I). The SH707 jumper block (see Figure 5–11) determines whether the the signal is isolated or non-isolated and sourcing or sinking.



Use the Left and Right arrow keys to move the cursor to the desired digit position and the Up and Down arrow keys to increment or decrement the value. When the desired value is displayed, press ENTER to return to the main PROCESS SETUP menu shown in Figure 7–5.

NOTE

The RTW symbol (RTW = Ready To Weld) at the bottom of each logical branch in the flowchart, means the DPC II Plus is logically capable of being triggered to generate an ultrasonic output. This is indicated on the display screen by the presence of the PROCESS SETUP menu shown in Figure 7–5.

Weld Method – Energy

If a Power Output module is installed, you can choose the Energy Welding method. The decision menu for choosing the Weld Method was shown in Figure 7–15. Use the down arrow key to move the cursor next to **WELD BY ENERGY** selection and press the ENTER key. To setup the Energy weld method, you must first enter the desired welding energy (see Figure 7–17).

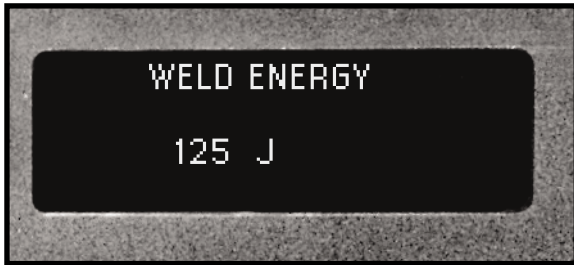

Figure 7–17 MPC Probe Weld Energy

Press ENTER and the maximum weld time data entry screen is displayed as shown in Figure 7–18. This is the time limit on the welding process if the specified energy has not been reached. Enter a value which permits the desired weld energy to be reached. Press the ENTER key to return home to the Process Setup menu.

Weld Method – Ground Detect

The **GROUND DETECT** welding method is available in both MPC Probe and Auto Probe configurations. In ground detect mode, the ultrasonic signal is initiated when the operate input is triggered and terminated when the horn touches the metal fixture during the welding cycle. For the ground detect fea-



DEFINITION

Power is defined as *Energy* per unit of *Time* (i.e. how fast energy is produced or consumed).

Energy is defined as the capacity to do *Work*. The release of energy does work, and in doing work on something, adds energy to it. Work and energy are equivalent concepts. The **Weld-By-Energy** mode measures energy in units of *Joules*. By definition, a *Watt* (power) is one *Joule* (energy) per *Second* (time). Therefore a *Joule* is equivalent to one *Watt-Second*.

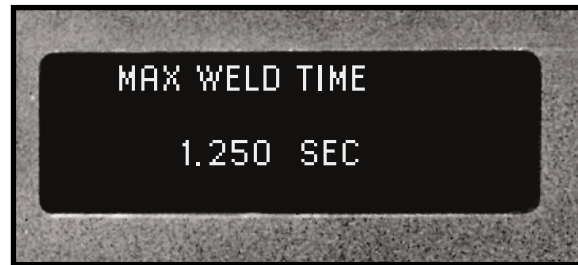
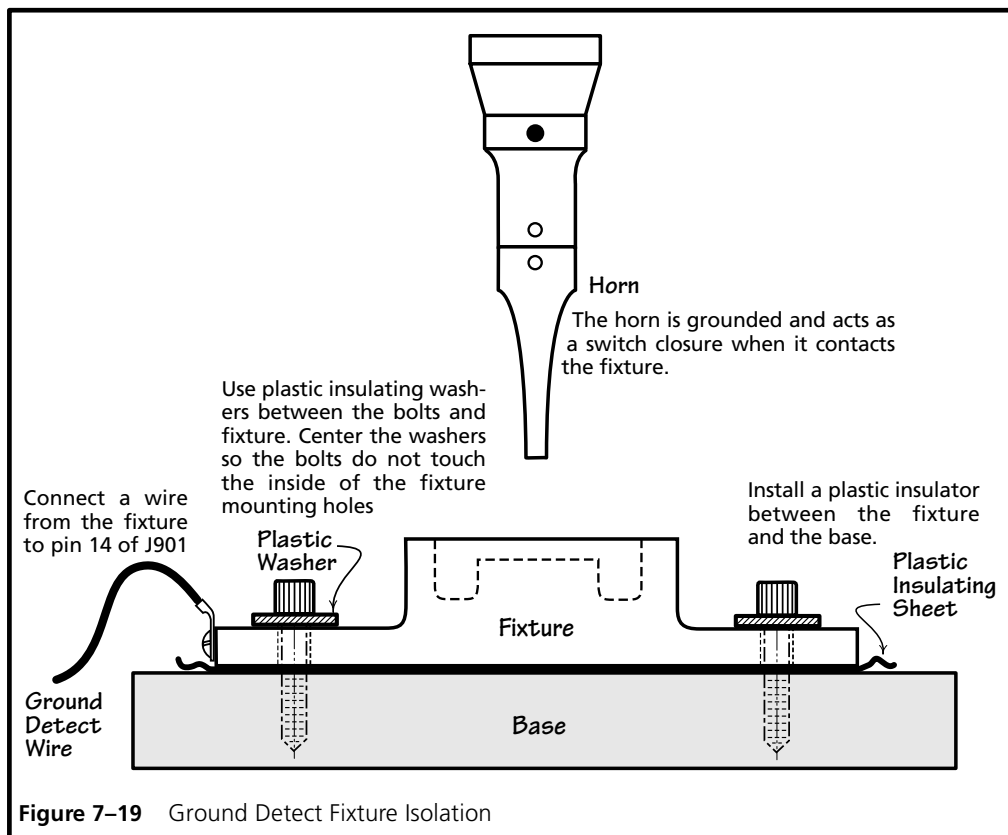

Figure 7–18 MPC Probe Maximum Weld Time



ture to function properly, the fixture must be electrically isolated from the horn support and base as shown in Figure 7–19. The horn is grounded and acts as a switch closure when it contacts the fixture. The ground detection is a current limited +5V DC signal on pin 14 of J901 which is the Thruster connector on the Press Control module. Ground detect is normally used with a press system.

The MPC module cannot be used simultaneously with a Press Control module. If the ground–detect function is needed with a MPC configuration, connect the ground detect wire from the isolated fixture to the Iso Auto Stop (pin 9) on the System Input HD–15 connector. This is a current limited +22V DC signal. Move the SH704 jumper block to JU715 and refer to the discussion of the Auto Stop option under Figure 7–13, since pin 9 is used to stop the weld in both cases.

Max Weld Time

Maximum Weld Time is the value at which the welding process terminates regardless of whether the ground detect signal or scrub process has been activated. The data entry screen for maximum weld time looks the same as the screens shown in Figures 7–11 and 7–18. Set the maximum weld time to a value greater than the time required to complete the welding cycle including the scrub time.

Scrub Time

Scrub Time is an extension of the welding cycle which is generated when the ground detect signal would normally end the weld cycle. This is typically used in cutting operations. Often the horn cuts through the material at a single point. This activates the ground detect to end the weld cycle. But the cut may not be complete, and the additional scrub time keeps the ultrasound signal on to complete the cut. The data entry screen for scrub time is shown in Figure 7–20. The maximum allowable time value is 0.150 seconds.

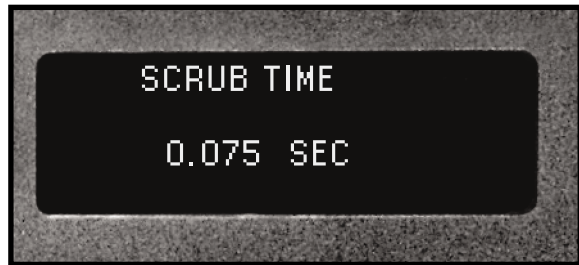

Figure 7–20 Ground Detect Scrub Time Data Entry

NOTE

The word AUTO in the menu options is short for Automation not automatic. Any menu that contains the word AUTO means the DPC II Plus will require an external signal(s) from custom automation equipment for correct operation.

AUTO Probe

The cable connection diagram for connecting an automated probe or an automated thruster is shown in Section 3 in Figures 3–5 and 3–7. The flow chart for the Process Control menu using Auto Probe is shown in Figure 7–21. If you do not have a Power Output module installed, the Energy Weld Method menu will not be displayed.

The Auto Probe Setup logic adds a Process Control menu before the Weld Method decision menu. Compare the flowchart in Figure 7–21 to the previous MPC flowchart in Figure 7–12. The Process Control menu offers two additional settings to control the welding process. After the normal Weld Method is programmed, Hold time and Afterburst settings are available.

1. The HOLD TIME parameter (T_{hold}) determines the length of time the probe is held in contact with the parts after the welding cycle has stopped. Holding permits the material to solidify under pressure before the head retracts.
2. In some applications, the material being welded can stick to the horn as it retracts. A short burst of ultrasonic energy called AFTERBURST prevents this. This operation is defined by two values. The delay after the start of the upstroke before the burst starts (T_{delay}) and the duration of the burst signal (T_{burst}). The maximum value of both of these parameters is 0.999 second.

AUTO STOP Option

The Auto Stop option is shown in Figure 7–13. It is designed for use with automation equipment and is available in both the Timed and Untimed Auto Probe Trigger Method. To use this option, move the SH704 jumper block to JU715 (see Figure 5–12). If Auto Stop is enabled, then a stop signal on pin 9 of the HD–15 SYSTEM IN connector will be recognized. This permits external automation equipment to stop the welding cycle. If Auto Stop is set to disable, then a signal on pin 9 will be ignored.

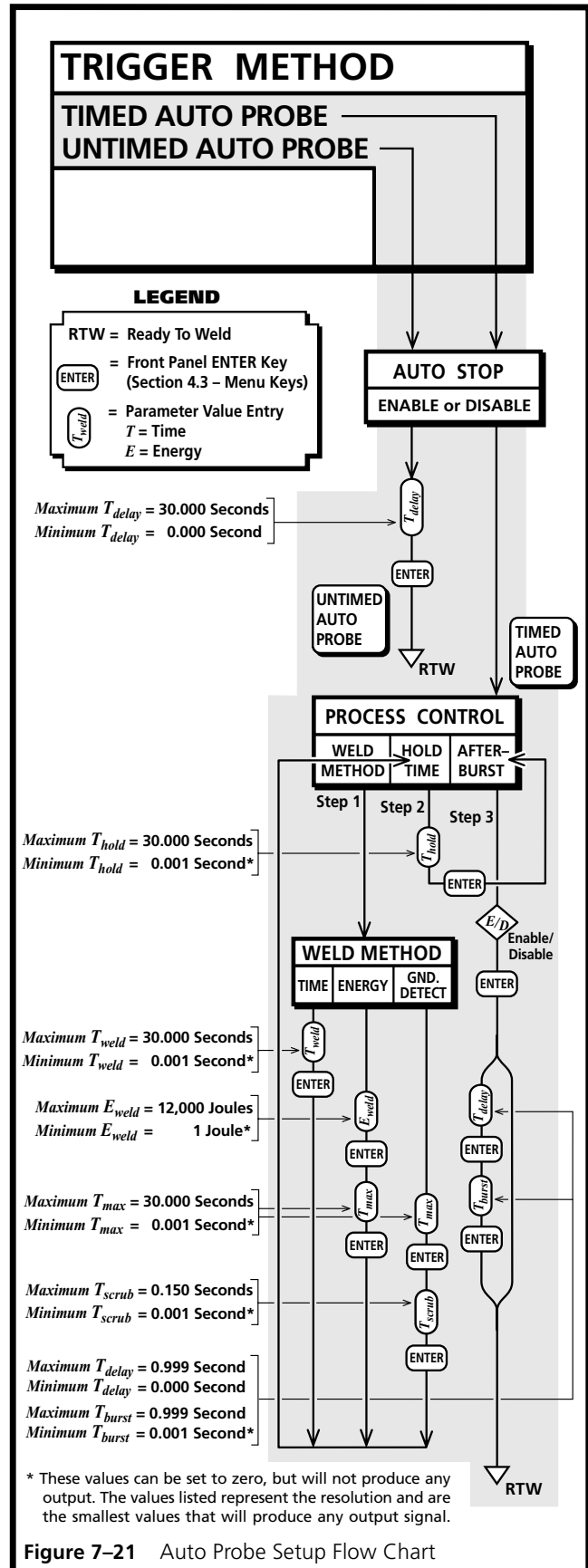

Figure 7–21 Auto Probe Setup Flow Chart

Untimed Auto Probe – Delay

The generator is triggered by external automation equipment. The automation control provides the ultrasound start and stop signal. In certain operations, a delay may be required to allow the clamping head(s) to fully engage before starting the ultrasound. The probe delay time menu for untimed operation was shown previously in Figure 7–14. This parameter sets the post-trigger delay. The maximum value which can be entered is 30.000 seconds. The minimum value for the Delay Time is 0.000 second which effectively disables any delay.

Process Control – Weld Method

In Timed Auto Probe mode, after choosing the Auto Stop option and pressing ENTER, the next menu displayed is titled Process Control as shown in Figure 7–22. The Process Control Menu includes the Weld Method and adds two more menu screens. Refer back to the Hand Probe and MPC Probe sections for information on the Time, Energy and Ground Detect Welding method menus.

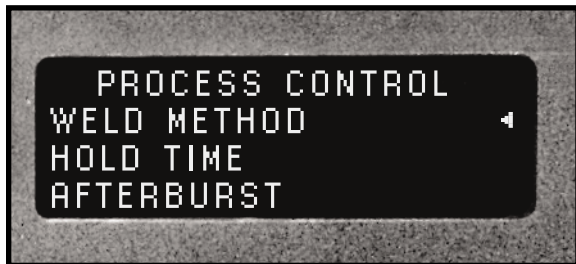

Figure 7–22 Process Control Weld Method Menu

Process Control – Hold Time

After the Weld Method has been chosen and parameter values entered, the menu flow returns back to Process Control but with Hold Time automatically selected. This is shown below in Figure 7–23.

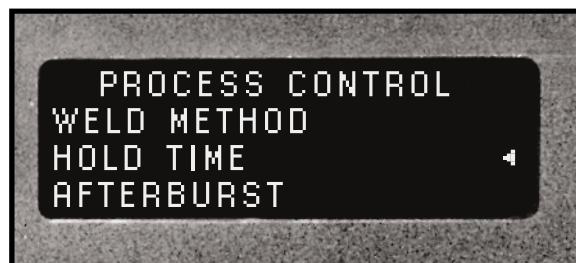

Figure 7–23 Auto Probe Process Control Hold Time Menu

The data entry screen for Hold Time is shown in Figure 7–24. The maximum allowable holding time is 30.000 seconds.

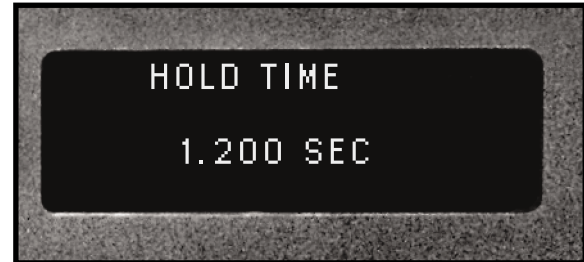

Figure 7–24 Auto Probe Hold Time Data Entry Screen

Process Control – Afterburst

After the hold time value has been entered, press the ENTER key to return back to the Process Control menu. Afterburst is now automatically selected as shown in Figure 7–25.

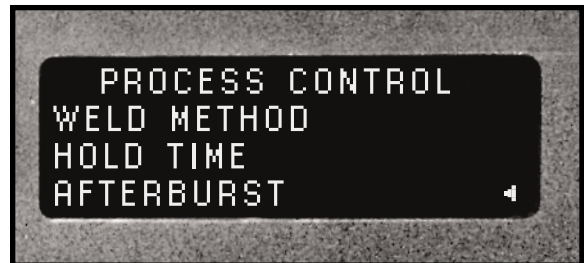

Figure 7–25 Auto Probe Process Control Afterburst Menu

Press the ENTER key to select the final set of welding parameters. To bypass the afterburst option, select DISABLE and press the ENTER key. You are then returned back to the Process Control menu (Figure 7–22). Press the CANCEL key once or the MODE key twice to return to the root Process Setup menu (Figure 7–29).

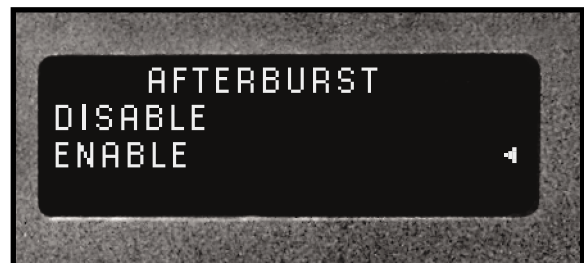

Figure 7–26 Auto Probe Afterburst Enable Menu

To select an afterburst, move the cursor down next to **ENABLE** as shown in Figure 7–26 and press the **ENTER** key.

To setup the afterburst, the menu prompts you for two parameter values. The first is the afterburst delay. This is the delay after the start of the upstroke before the burst starts. This data entry screen is shown in Figure 7–27. Use the arrow keys to display the desired value and press the **ENTER** key.

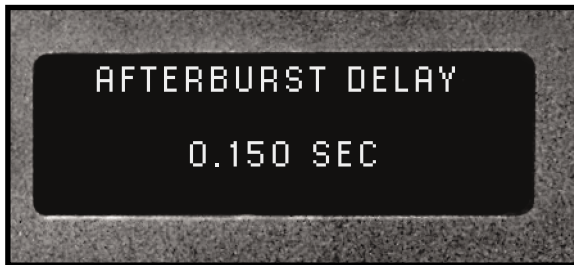

Figure 7–27 Auto Probe Afterburst Delay Data Entry

The menu now prompts you for the afterburst signal duration. This screen is shown in Figure 7–28. Again enter the desired signal duration and press the **ENTER** key.

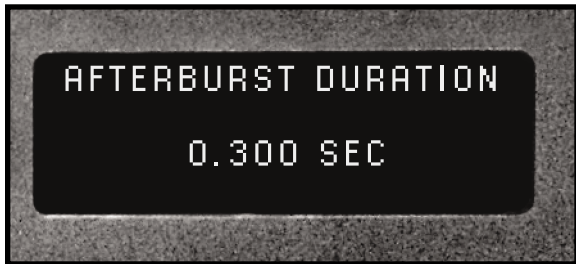

Figure 7–28 Auto Probe Afterburst Duration Data Entry

This returns you to the Process Control menu as shown in Figure 7–22. Press the **CANCEL** key once or the **MODE** key twice to return to the root Process Setup menu shown in Figure 7–29.

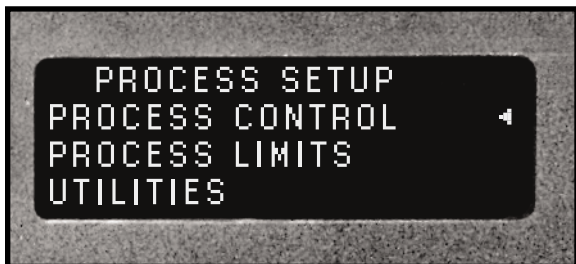
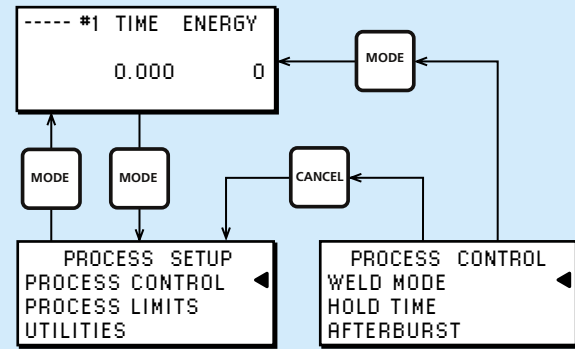

Figure 7–29 Process Setup Menu

NOTE

The RTW symbol in the flow chart is signified by the display of the **PROCESS CONTROL** menu. From the **PROCESS CONTROL** menu, press the **MODE** key twice or the **CANCEL** key once to return to the root **PROCESS SETUP** menu.



PRESS Mode

The cable connection diagram for connecting a DPC II Plus to a Dukane press is shown in Section 3 in Figures 3–8. The flow chart for the Process Control menu is shown in Figure 7–30. If a Press Control module is not installed, this menu will not be displayed. If you do not have a Power Output module installed, the Energy Weld Method menu options will not appear either.

The Press Setup logic features two areas of enhancement over the Auto Probe logic. The PRESS TRIGGER METHOD has three additional control options in the Auto Stop logical branch (the Auto Probe trigger methods are still available). The WELD MODE menu is also expanded and offers a choice of SINGLE PRESSURE or DUAL PRESSURE mode. Compare the flowchart in Figure 7–30 to the previous Auto Probe flowchart in Figure 7–21.

1. The TRIGGER METHOD – PRESS mode has an INITIATE MODE menu preceding Auto Stop. The MANUAL mode is the recommended setting. This permits the dual palm switches on the press base to initiate the operate sequence.
2. If ENABLE was selected in the AUTO STOP menu, the HEAD UP ON AUTO STOP menu is displayed. Auto Stop has been covered previously under MPC Probe and AUTO Probe. The HEAD UP menu determines whether the press head remains at its last position or retracts when an external Auto Stop signal is detected.

NOTE

The symbol legend for the Press Mode flow chart is the same as the other flow charts. It is repeated here for your convenience.

LEGEND

RTW = Ready To Weld	
	= Front Panel ENTER Key (Section 4.3 – Menu Keys)
	= Parameter Value Entry
	T = Time
	E = Energy

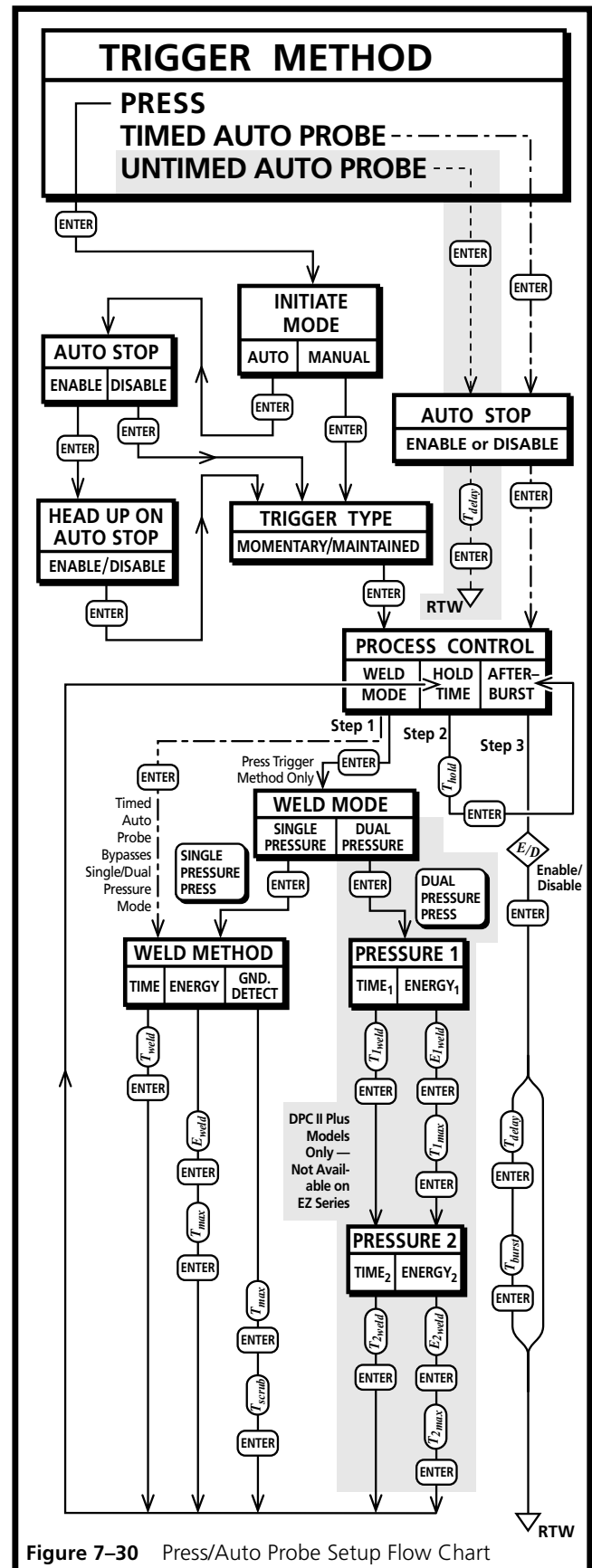

Figure 7–30 Press/Auto Probe Setup Flow Chart

3. If **DISABLE** was selected in the **AUTO STOP** menu, the **TRIGGER TYPE** menu is displayed next. This selects whether the trigger which initiates the weld cycle is momentary or must be maintained throughout the weld cycle.
4. The **SINGLE PRESSURE** mode follows the same programming sequence as Weld Method in the previous Timed Auto Probe. The **DUAL PRESSURE** mode eliminates ground detect for obvious reasons and allows welding by Time or Energy at both pressure level settings.

Initiate Mode

When using a press, the usual choice is to select **MANUAL** for the Initiate Mode. This permits the dual palm switches to initiate the operate sequence. If **AUTO** mode is selected, then an external initiate signal must be supplied to either pins 3 and 4 (Iso Oper In) or pin 8 (Sw Oper In) of the HD-15 System In connector. Refer back to Figure 5-2 and Table 5—I for more information.

Auto Stop

The normal configuration when using a press is to set Auto Stop to **DISABLE**. This permits the standard emergency OFF switch on the front of the press base to halt the weld cycle. If Auto Stop is set to **ENABLE**, then an external signal must be supplied to pin 9 (Iso Auto Stop) of the HD-15 System In connector. Refer back to the discussion under Figure 7-13 and also to Table 5—I for more detailed information.

Head Up On Auto Stop

If **DISABLE** was selected in the **AUTO STOP** menu, the **HEAD UP ON AUTO STOP** menu is bypassed. If **ENABLE** was selected in **AUTO STOP**, the **HEAD UP** menu is displayed. It offers two choices for head position. If **ENABLE** is selected for the Head Up option, the head retracts when an Auto Stop signal is detected. If the **DISABLE** option is selected, the press head remains stationary after an Auto Stop signal. Note that this option and Auto Stop are only available when the Initiate Mode has been set to Auto.

NOTE

The word **AUTO** in the menu options is short for Automation not automatic. Any menu that contains the word **AUTO** means the DPC II Plus will require an external signal(s) from custom automation equipment for correct operation.

Trigger Type

If **DISABLE** was selected in the **AUTO STOP** menu, the **TRIGGER TYPE** menu is displayed next. Otherwise it follows the **HEAD UP ON AUTO STOP** menu.

If **MOMENTARY** is selected, the trigger switch is ignored after the first contact closure. The DPC external bus scan time is 1 msec so the minimum signal duration is >1 msec. If the trigger switch opens after the weld cycle is initiated, the welding processes continues normally. Momentary is recommended for most welding processes except hand probes.

If **MAINTAINED** is selected, the trigger must be maintained during the entire portion of the weld cycle. If the trigger signal is momentarily lost while the ultrasonic signal is on, the weld cycle is terminated. This mode is recommended for special applications. It has an advantage over momentary trigger in that it will generate a **TRIGGER LOST** error message if you suddenly lose trigger force (see Error Messages in Section 12 – Troubleshooting). This may happen when welding soft plastic or small parts.

Single/Dual Pressure Mode

The **SINGLE PRESSURE** mode has the same programming sequence as Weld method in the previous Timed Auto Probe. The **DUAL PRESSURE** mode eliminates ground detect and allows Time or Energy target values to be used at both pressure trigger points. The modes can be mixed us-

ing Energy for the first mode and Time for the second mode or vice versa. Each of the blocks labeled Pressure 1 and Pressure 2 are equivalent to the Single Pressure Weld Method branch without Ground Detect. Note that the Auto Probe Trigger Method bypasses the Single/Dual Pressure Weld Mode and jumps directly to Weld Method.

The Dual Pressure mode is a feature exclusive to the DPC II Plus model and is not available on the EZ Series.

PRESS Mode Example

We will now go through programming a typical press configuration with no automation and using dual pressure mode. We will assume that a Power Output module is also installed. If your configuration does not have this module, you can still follow along and substitute Time anywhere we have selected Energy.

We will start from an initial DPC power up, so cycle the AC power switch off then back on. If you are using a dual-pressure press, make sure the pressure select switch is in the WELD position. The screen first displays the firmware revision and then the hardware configuration as shown in Figures 7-1 and 7-2. The screen then displays the previous weld cycle data on the Operate screen. This is shown in Figure 7-4 which is repeated here as Figure 7-31. If you do not have a Power Output module, your screen will look like Figure 7-3.

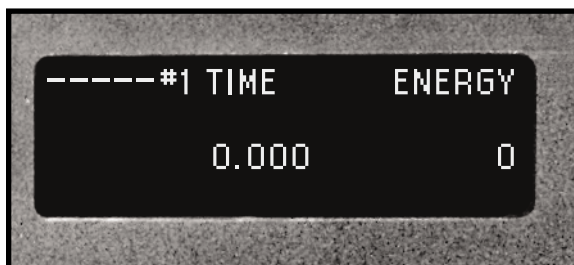

Figure 7-31 Previous Welding Cycle Data

Press the **MODE** key once (see Figure 7-32) and the screen changes from the Operate screen to the Process Setup menu as shown in Figure 7-33.

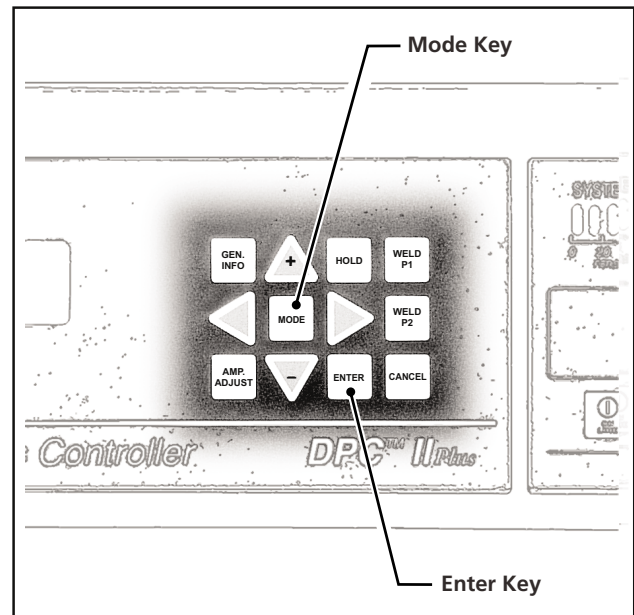

Figure 7-32 Mode and Enter Menu Keys

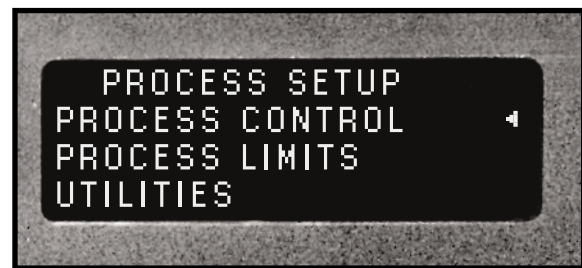

Figure 7-33 Process Setup Menu

Process Control is selected by default. Press the **ENTER** key to display the Trigger Method menu shown below in Figure 7-34.

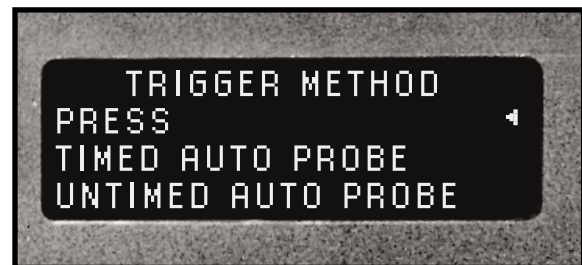

Figure 7-34 Press Trigger Method Menu

The **PRESS** option should be selected by default. If it isn't, use the increment key (up arrow) to position the cursor and then press **ENTER**.

The menu changes to display the Initiate mode as shown in Figure 7–35. We will assume a standard press configuration using the dual palm operate switches. Since we will manually trigger the press, move the cursor to **MANUAL** and press **ENTER**.

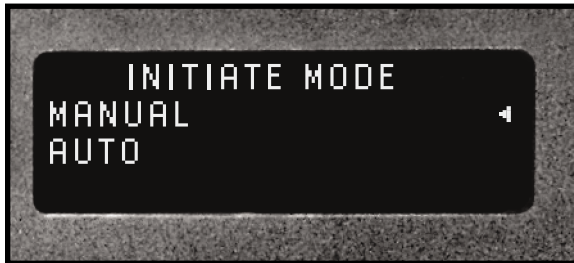

Figure 7–35 Press Initiate Mode Menu

You can see from the flow chart in Figure 7–30 that we bypass both the **AUTO STOP** and **HEAD UP ON AUTO STOP** menus when we select manual mode. The next menu displayed is **TRIGGER TYPE** which is shown in Figure 7–36.

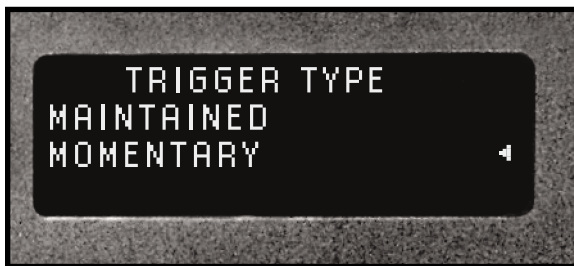

Figure 7–36 Press Trigger Type

The trigger type used for most welding conditions should be **MOMENTARY**. Use the down arrow key to select Momentary and press **ENTER**. We are now at the central Process Control menu. It is shown below in Figure 7–37.

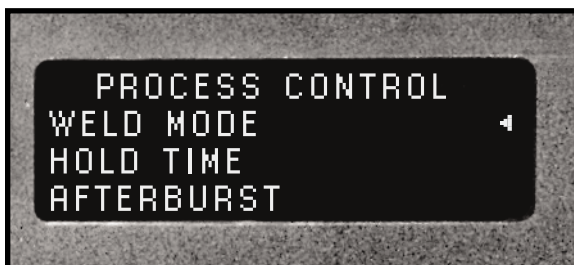

Figure 7–37 First Pass Through Process Control Menu

The cursor is pointing to **Weld Mode** by default. Note there is a small difference between the wording of the Process Control menu for Press and for

Auto Probe. The Press option reads **Weld Mode** whereas the Auto Probe menu reads **Weld Method**. We leave **WELD MODE** selected and press **ENTER**. The next menu (Figure 7–38) appears only in press mode. It is titled **Weld Mode** and offers a choice of welding modes. You must have a dual–pressure press to use the dual pressure mode. A single pressure press displays **Weld Method** (see Figure 7–15).

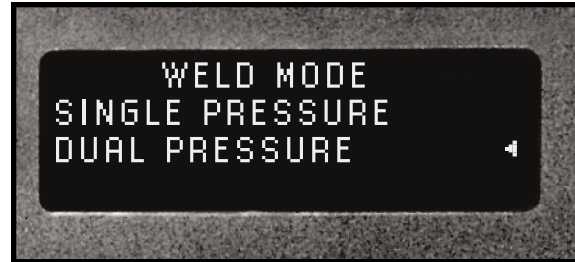

Figure 7–38 Single or Dual Pressure Selection Menu

To demonstrate the complete set of options, we will select **DUAL PRESSURE** and push the **ENTER** key. We can select time or energy as the welding parameter during the **P1** portion of the welding cycle. This corresponds to the block labeled **PRESSURE 1** in Figure 7–58. Select **WELD BY TIME** and press the **ENTER** key.

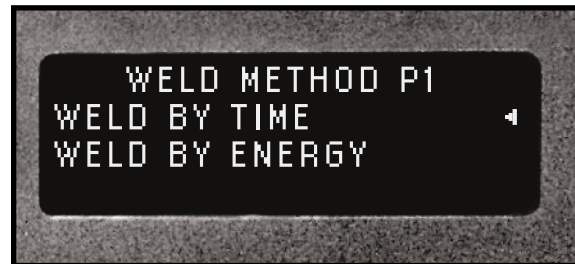

Figure 7–39 Pressure One Weld Method Selection Menu

A data entry screen appears requesting the value of the weld time for pressure one. On the flow chart (Figure 7–30) this is labeled $T_{1\text{weld}}$. The data entry screen is shown below in Figure 7–40.



Figure 7–40 Pressure One Weld Time Data Entry

Using the four arrow keys, enter the weld time. Press the ENTER key when you have completed the data entry. This displays the Weld Method selection screen for Pressure Two as shown in Figure 7-41.

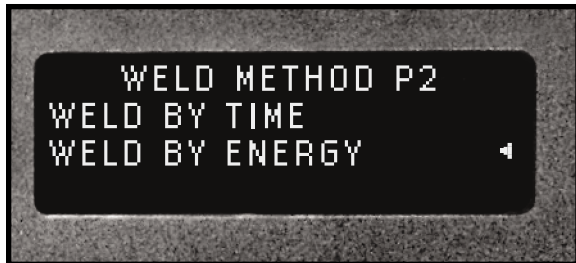

Figure 7-41 Pressure Two Weld Method Selection Menu

This time select WELD BY ENERGY and press the ENTER key. This brings up the data entry screen for pressure two as shown below in Figure 7-42. If you do not have a Power Output module, the energy option will not appear. Figure 7-44 shows the logical flow for dual pressure mode without the energy option.

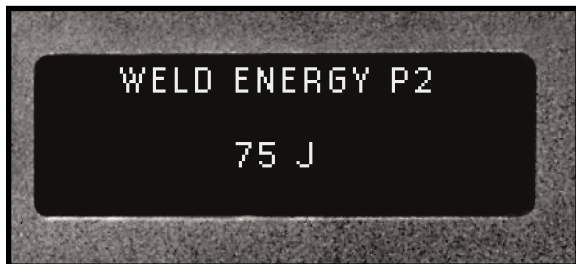

Figure 7-42 Pressure Two Weld Energy Data Entry

Again use the arrow keys to enter the weld energy. This parameter is labeled E_{2weld} on the flow chart. Press the ENTER key when you have finished to bring up the data entry screen for P2 Maximum Weld Time as shown in Figure 7-43. This value sets the time limit to reach the P2 weld energy. This time limit applies only to the P2 cycle.

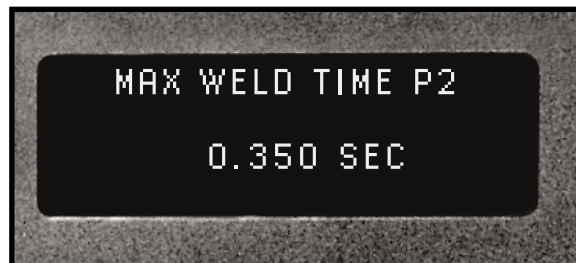

Figure 7-43 Pressure Two Max Weld Time Data Entry

Dual Pressure Weld Mode Menus w/o Power Output Module

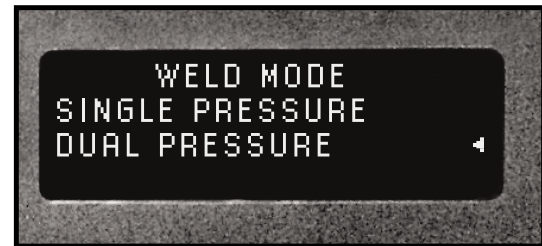

Figure 7-44 Dual Pressure Time Only Menus

If we select energy for the P1 cycle, it will have its own maximum weld time limit. Press the ENTER key to return to the Process Control menu as shown in Figure 7-45.

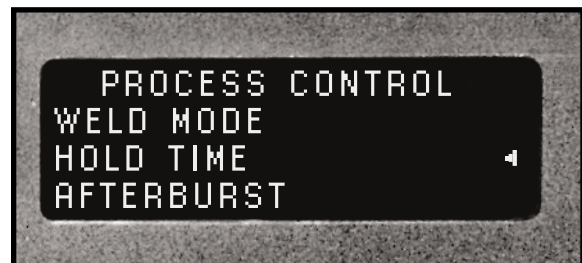

Figure 7-45 Second Pass Through Process Control Menu

From here on, the menu follows the same logical sequence as Auto Probe. Hold Time is automatically selected for the second pass through Process Control. Press the ENTER key to display the Hold Time data entry menu as shown in Figure 7-46. Enter a value for the hold time and press the ENTER key.

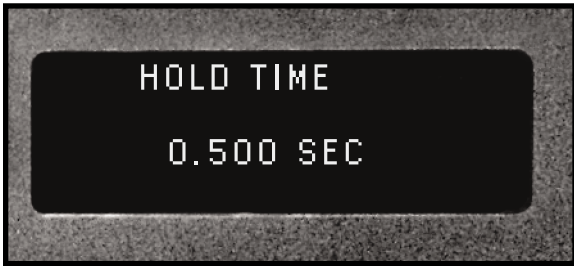

Figure 7-46 Press Hold Time Data Entry

We return for a third time to the Process Control menu. This time the Afterburst option is automatically selected as shown in Figure 7-47.

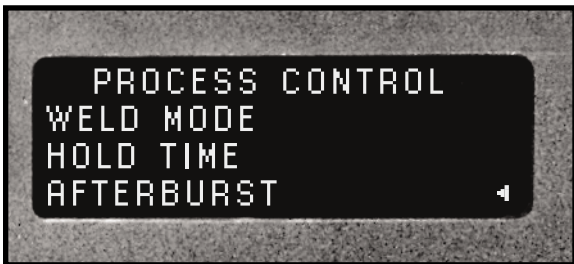

Figure 7-47 Third Pass Through Process Control Menu

Press the ENTER key to display the Afterburst menu. This permits you to enable or bypass the afterburst option. To bypass the afterburst option, select DISABLE and press the ENTER key. You then jump back to Process Control as shown in Figure 7-51. To select an afterburst, move the cursor down to ENABLE as shown in Figure 7-48 and press the ENTER key.

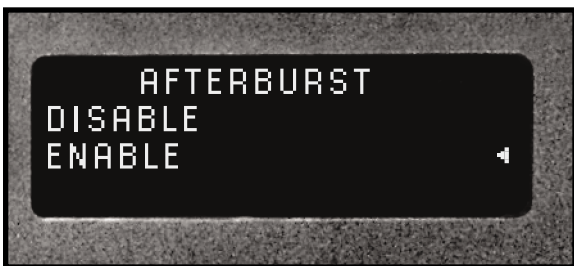

Figure 7-48 Press Afterburst Enable Menu

The data entry screen for the afterburst delay appears as shown in Figure 7-49. Enter a value for the delay time and press the ENTER key.

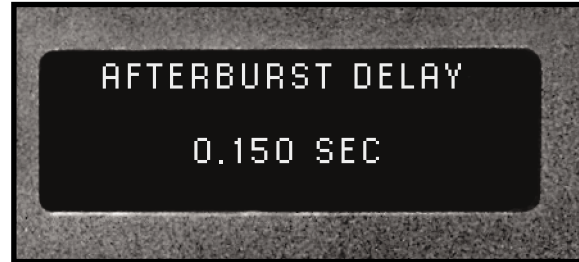

Figure 7-49 Press Afterburst Delay Data Entry

The data entry screen for the afterburst duration appears as shown in Figure 7-50. Enter a value for the burst time and press the ENTER key.

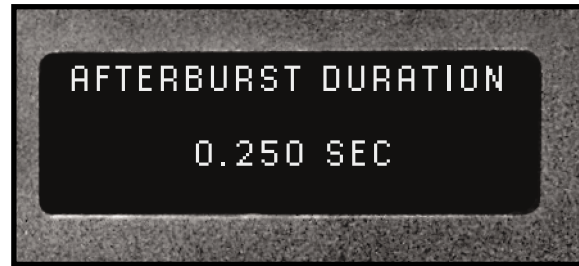

Figure 7-50 Press Afterburst Duration Data Entry

The Process Control menu screen appears again with Weld Mode selected. This screen below in Figure 7-51 looks just like Figure 7-37.

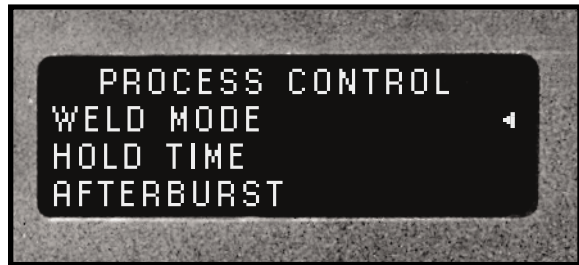

Figure 7-51 Return To Process Control Menu

We have now defined the welding mode and set values for the necessary parameters. Press the **CANCEL** key once to return to the root Process Setup menu shown in Figure 7–52 (the same as Figure 7–33).

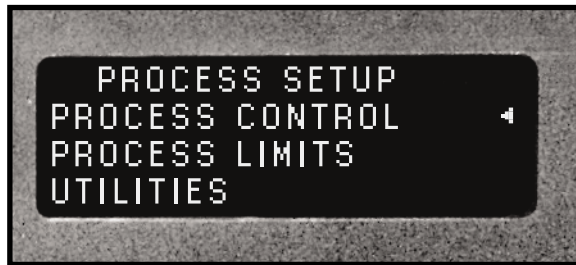

Figure 7–52 Process Setup Menu

Press the **MODE** key to display the welding parameters menu. Notice it now has three values: P1, P2 and Total. This is different from the operate screen in Figure 7–31 because we are now configured for a dual pressure mode instead of single pressure.

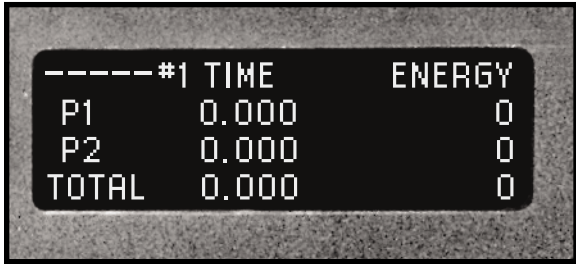

Figure 7–53 Dual Pressure Welding Cycle Data

Press the **MODE** key again to return to the Process Setup menu.

HOT Keys

In Section Four – Controls and Displays, we explained the function of the menu keys including the four hot keys: **HOLD**, **WELD P1**, **WELD P2** and **AMP. ADJUST**. The hot keys are identified in Figure 7–54. Since we have now programmed values for these parameters, we can use the hot keys to check or alter their values.

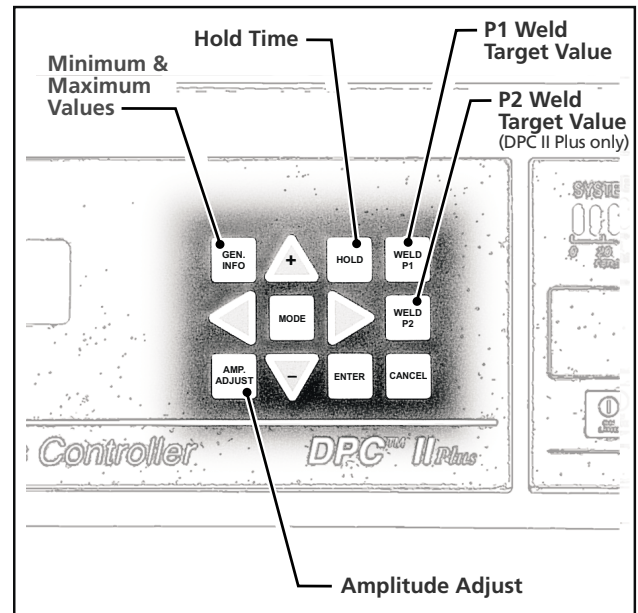

Figure 7–54 HOT Keys

Press the **HOLD** key and the menu displays the value entered for the hold time (see Figure 7–46). Press the **GEN. INFO** key to display the minimum and maximum values for hold time. This is illustrated in Figure 7–55. Press the **CANCEL** key to return to the Hold Time menu and once more to return to the Process Setup menu.

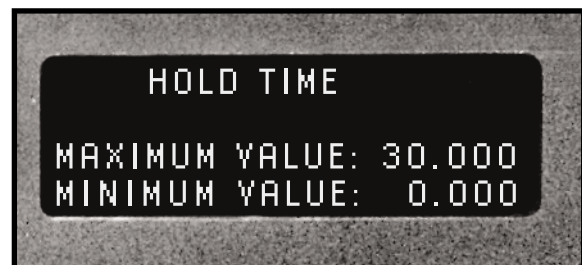

Figure 7–55 Min and Max Values for Hold Time

To modify the Hold Time, use the arrow keys to change the value as shown in Figure 7–56. To ac-

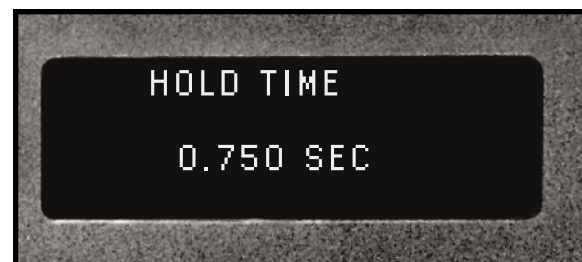

Figure 7–56 Modified Hold Time

cept the new value press the **ENTER** key. This will return you to the Process Setup menu shown in Figure 7–52. To return to Process Setup without modifying the hold time, press the **CANCEL** key.

The **WELD P1** and **WELD P2** hot keys function in the same manner. If a single pressure mode is selected (Figure 7–38 = **SINGLE PRESSURE**), then only the **Weld P1** key will display information. Pressing the **Weld P2** hot key flashes a brief message reading **THIS BUTTON IS ONLY AVAILABLE FOR DUAL PRESSURE WELD MODE**.

The **AMP. ADJUST** hot key permits you to adjust the output amplitude from 40% to 100%. This is accomplished using the up and down arrow keys. A modified output level menu is shown in Figure 7–57. Press the **ENTER** key to accept the value or **CANCEL** to return to Process Setup.

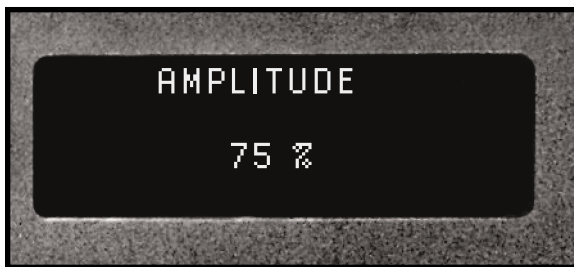

Figure 7–57 Amplitude Adjust

Process Control Recap

We have examined all four modes available in the Process Control menu: **Hand Probe**, **MPC Probe**, **Auto Probe** and **Press**. Figure 6–6 showed the Process Control flow chart. It did not however indicate the parameters and where their values were entered. We have added that information and the complete flowchart is shown in Figure 7–58. The symbol legend in the upper right hand corner of the flow chart explains the Figure number references and parameter data. The **ENTER** key symbols shown in Figures 7–7, 7–12, 7–21 and 7–30 are not shown here for readability.

NOTE

If you have a dual-pressure press connected to the DPC II Plus, make sure the pressure select switch is in the **WELD** position before turning on the DPC AC power. The DPC scans for installed modules, connected press and probe, etc. at power-up. If the switch is in **HOLD** position, the DPC II Plus may not correctly recognize the press.



Switch Must Be In **WELD PRESSURE** Position Before Turning The DPC Power On.

NOTE – This only applies to the DPC II Plus. The EZ Welder System is a single pressure press.

NOTE

If you have a **Remote Amplitude Control** module installed, its gain setting will override the front panel menu. The front panel menu will accept the value, but the output amplitude will still be determined by the 4–20mA loop current. Refer back to Section 5 and Figure 5–6 for more detailed specifications.

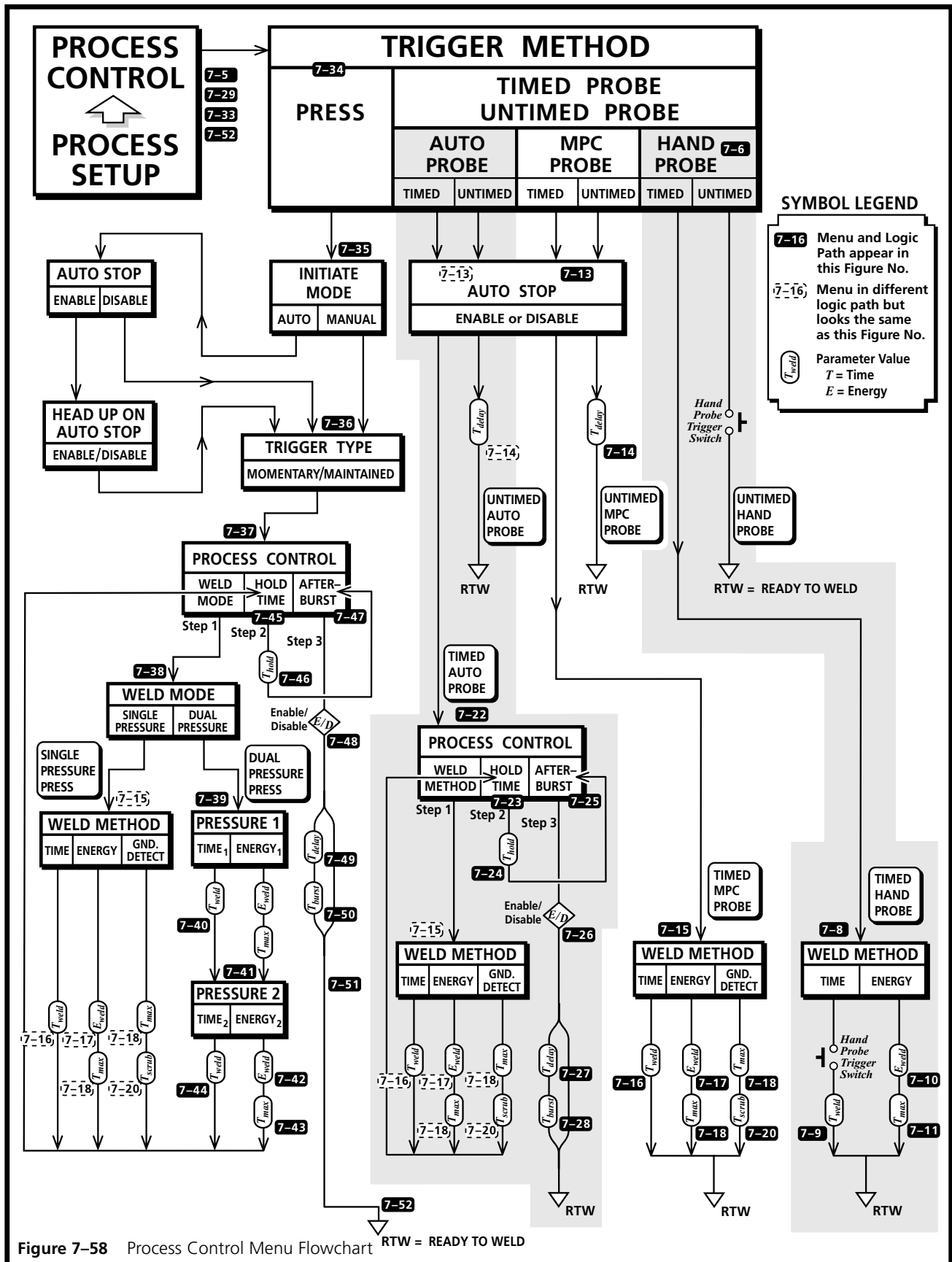

Figure 7-58 Process Control Menu Flowchart RTW = READY TO WELD

Table 7—I below summarizes the various method and mode menus and references their Figure number. Table 7–II on the next page lists the data entry screens and references their Figure number. It also gives the minimum and maximum values for each of the parameters. The only variation between models is for weld energy. The high–frequency (50kHz and 70kHz) models have a lower power output, and the scale factor change enables 0.1 Joule resolution at these lower power levels.

Menu Name	Description	Figure No.	Remarks
STARTUP	DPC II Plus Firmware Version and Date	6–1, 7–1	
CONFIGURATION	Installed Modules	6–2, 7–2	Press Board or Power Output Modules
WELD CYCLE DATA	Previous Weld Cycle Data	6–3, 7–3 7–4, 7–53	
PROCESS SETUP	Root Menu	7–4, 7–29 7–33, 7–52	
TRIGGER METHOD	Probe - Timed or Untimed	7–6	
TRIGGER METHOD	Press	7–34	
WELD METHOD	Weld By Time or Energy	7–8	
WELD METHOD	Weld By Time, Energy or Ground Detect	7–15	
AUTO STOP	Enable or Disable	7–13	
PROCESS CONTROL	Weld Method	7–22	Probe Trigger Method
PROCESS CONTROL	Weld Mode	7–37, 7–51	Press Trigger Method Only
PROCESS CONTROL	Hold Time	7–23, 7–45	
PROCESS CONTROL	Afterburst	7–25, 7–47	
AFTERBURST	Enable or Disable	7–26, 7–48	
INITIATE MODE	Manual or Auto	7–35	Press Trigger Method Only
TRIGGER TYPE	Momentary or Maintained	7–36	Press Trigger Method Only
WELD MODE	Single or Dual Pressure	7–38	Press Trigger Method Only
WELD METHOD P1	Time or Energy	7–39	Dual Pressure Mode Only
WELD METHOD P2	Time or Energy	7–41	Dual Pressure Mode Only

Table 7–I Process Control Menu Listing

Parameter	Menu Name	Description	Trigger Method	Weld Method	Figure No.	Minimum Value	Maximum Value
T_{delay}	Probe Delay	Post-Trigger Delay	Untimed MPC/Auto Probe	Untimed Probe Only	7-14	0.000 Second	30.000 Seconds
T_{weld}	Weld Time	Ultrasound Gate Time	Press & Any* Timed Probe	Time	7-8, 7-16	0.000 Second	30.000 Seconds
E_{weld}	Weld Energy	Target Welding Energy	Press & Any* Timed Probe	Energy	7-10, 7-17	0 Joules	12000 Joules [†]
T_{max}	Max Weld Time	Welding Time Limit	Press & Any* Timed Probe	Energy	7-11, 7-18	0.000 Second	30.000 Seconds
T_{max}	Max Weld Time	Welding Time Limit	Press, MPC & Auto Probe	Ground Detect	7-11, 7-18	0.000 Second	30.000 Seconds
T_{scrub}	Scrub Time	Scrub Gate Time	Press, MPC & Auto Probe	Ground Detect	7-20	0.000 Second	0.150 Seconds
T_{hold}	Hold Time	Post-Weld Hold Time	Press & Auto Probe	Time & Energy	7-24, 7-46	0.000 Second	30.000 Seconds
T_{delay}	Afterburst Delay	Burst Time Delay	Press & Auto Probe	Time & Energy	7-27, 7-49	0.000 Second	0.999 Second
T_{burst}	Afterburst Time	Burst Gate Time	Press & Auto Probe	Time & Energy	7-28, 7-50	0.000 Second	0.999 Second
$T1_{weld}$	Weld Time	Ultrasound Gate Time	Press – Dual Pressure	Time – Pressure 1	7-40	0.000 Second	30.000 Seconds
$T2_{weld}$	Weld Time	Ultrasound Gate Time	Press – Dual Pressure	Time – Pressure 2	7-44	0.000 Second	30.000 Seconds
$E1_{weld}$	Weld Energy	Target Welding Energy	Press – Dual Pressure	Energy – Pressure 1	similar to 7-42	0 Joules	12000 Joules [†]
$T1_{max}$	Max Weld Time	Welding Time Limit	Press – Dual Pressure	Energy – Pressure 1	similar to 7-43	0.000 Second	30.000 Seconds
$E2_{weld}$	Weld Energy	Target Welding Energy	Press – Dual Pressure	Energy – Pressure 2	7-42	0 Joules	12000 Joules [†]
$T2_{max}$	Max Weld Time	Welding Time Limit	Press – Dual Pressure	Energy – Pressure 2	7-43	0.000 Second	30.000 Seconds

Table 7—II Parameter Min–Max Values * Any Timed Probe = Timed Hand Probe 12000 Joules[†] = 20kHz, 30kHz and 40kHz DPC II Plus
Timed MPC Probe 1200.0 Joules[†] = 50kHz and 70kHz DPC II Plus
Timed Auto Probe (Requires Power Output Module)

NOTE

The 50kHz/150 Watt DPC II Plus and the 70kHz/100 Watt DPC II Plus have a maximum weld energy setting (E_{weld}) of 1200.0 Joules. The reduced scaling permits the DPC to achieve better adjustment resolution at low power levels. All other models covered in this manual have a maximum weld energy of 12,000 Joules.

This page intentionally left blank

Process Limits Menu

- Limit Definition
- Suspect and Bad Limits
- Process Limits

Process Limits Menu	89
Limit Definition	90
Suspect and Bad Limits	90
Process Limits	90
Single Pressure Mode	91
Dual Pressure Mode	92

This page intentionally left blank

Process Limits Menu

The Process Limits Menu allows you to define upper and lower bounds for suspect parts or for bad parts. The limits are available in both units of time and units of energy depending upon the welding method chosen in Process Control setup. In addition, if a dual–pressure welding method is selected, total time and/or total energy limits are also available for suspect or bad parts. The same memory location is used for suspect and bad part limits. The difference is that exceeding a bad part limit terminates the weld cycle. Exceeding a suspect limit allows the weld cycle to continue until it finishes normally or exceeds a Total limit. There are 12 different limit settings which are broken down as follows:

- 1a. There are two possible BAD PART UPPER TIME LIMITS (one for each pressure level).
- 1b. There are two possible BAD PART UPPER ENERGY LIMITS (one for each pressure level).
- 1c. There is one TOTAL BAD PART UPPER TIME LIMIT and one TOTAL BAD PART UPPER ENERGY LIMIT. This makes a total of six BAD PART UPPER LIMITS.
2. There are six BAD PART LOWER LIMITS.

During a dual–pressure mode welding cycle however, only six of the limits (eight in mixed mode) are applicable. In single pressure mode, this drops to two usable limits at any one time since the totals are available only in dual mode. For example, you can set both upper time and energy limits, but only the upper time limit is recognized in the weld by time mode.

Table 8—I summarizes the 8 limits recognized in a dual–pressure, mixed–mode welding cycle.

Table 8—II summarizes the 6 limits recognized in a dual–pressure, uniform–mode welding cycle.

Table 8—III lists the 2 limits recognized in a single–pressure welding cycle.

A Bad Parts Counter is also available in the Utilities menu which is covered in the next section.

DEFINITION

A *mixed* mode is a dual–pressure weld cycle in which one unit of measurement (e.g. time) is used for Pressure 1 and the other unit of measurement (e.g. energy) is used for Pressure 2.

A *uniform* mode is a dual–pressure weld cycle in which the same unit of measurement (e.g. time) is used for both Pressure 1 and Pressure 2.

Cycle State	Parameter Limit Type
P1 $T(E)_U$	P1 Upper TIME(ENERGY) Limit
P2 $E(T)_U$	P2 Upper ENERGY(TIME) Limit
Total T_U	Total Upper TIME Limit
Total E_U	Total Upper ENERGY Limit
P1 $T(E)_L$	P1 Lower TIME(ENERGY) Limit
P2 $E(T)_L$	P2 Lower ENERGY(TIME) Limit
Total T_L	Total Lower TIME Limit
Total E_L	Total Lower ENERGY Limit

Table 8—I Recognized Limits in a Dual–Pressure Mixed–Mode Welding Cycle

Cycle State	Parameter Limit Type
P1 $T(E)_U$	P1 Upper TIME(ENERGY) Limit
P2 $T(E)_U$	P2 Upper TIME(ENERGY) Limit
Total $T(E)_U$	Total Upper TIME(ENERGY) Limit
P1 $T(E)_L$	P1 Lower TIME(ENERGY) Limit
P2 $T(E)_L$	P2 Lower TIME(ENERGY) Limit
Total $T(E)_L$	Total Lower TIME(ENERGY) Limit

Table 8—II Recognized Limits in a Dual–Pressure Uniform–Mode Welding Cycle

Cycle State	Parameter Limit Type
P1 $T(E)_U$	P1 Upper TIME(ENERGY) Limit
P1 $T(E)_L$	P1 Lower TIME(ENERGY) Limit

Table 8—III Recognized Limits in a Single–Pressure Welding Cycle

Limit Definition

To access the Limit settings, start from the Process Setup menu shown in Figure 8–1.

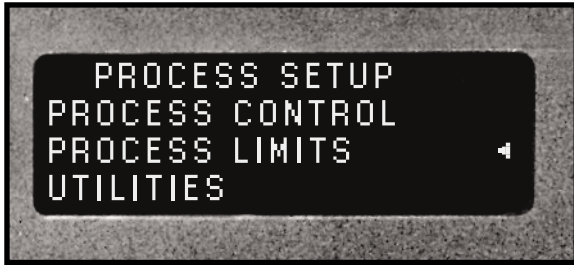

Figure 8–1 Process Setup Main Menu

Select **PROCESS LIMITS** with the cursor and then press **ENTER**. This displays the **LIMIT DEFINITION** menu as shown in Figure 8–2. These steps are indicated at the top of Figure 8–4 which is the flow chart for the Limit Definition. Both the suspect Limits and Bad Limits share the same logical structure, so no distinction is made between them in this flow chart.

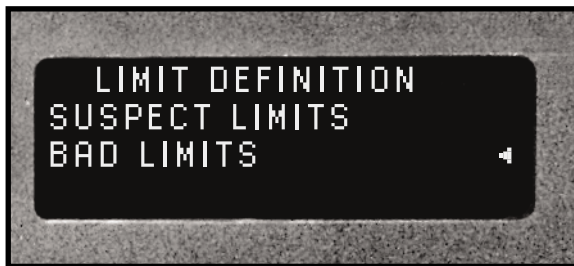

Figure 8–2 Limit Definition Menu

Suspect & Bad Limits

You can select either a Suspect or Bad Part Limit. A Suspect Limit allows the weld cycle to continue, but causes an error indication in the display (> or < for upper or lower limit). If a Bad Limit is exceeded, the weld cycle is terminated, and an error indication is displayed (>> or << for upper or lower limit) until the next weld cycle is initiated. A bad limit and suspect limit value share the same memory location. To change a Suspect Limit value to a Bad Limit value, move the cursor to **BAD**



LIMIT SELECTION

You normally select the alternate unit of measurement for bad and suspect limits. If you are welding by time (*Seconds*), all the weld cycles have the same weld time. There should be no measurable deviation from the target time value. There will however, be some variation in the power drawn by each part. Since the time is constant, the power and thus the energy will vary slightly between parts. The limit check therefore should be in units of energy (*Joules*). Too low an energy draw might result from a mechanical stop interfering with travel. Too much energy drawn may be caused by a misaligned part resulting in a large mating surface area.

If you are using dual–pressure mixed mode, a good limits check would set the companion limit for each pressure plus the total time and energy limits. In a dual–pressure uniform mode, only the alternate units for **P1**, **P2** and **TOTAL** will be meaningful.

LIMITS in the Limit Definition menu and press **ENTER**. The value is now associated with a Bad Limit and will now terminate the weld cycle if the measured value fall outside the boundary limits.

Process Limits

Select either Suspect Limits or Bad Limits and press the **ENTER** key. The choice can be easily changed later. The Process Limits menu is then displayed. This is shown in Figure 8–3 as it would appear for a single–pressure mode weld cycle.

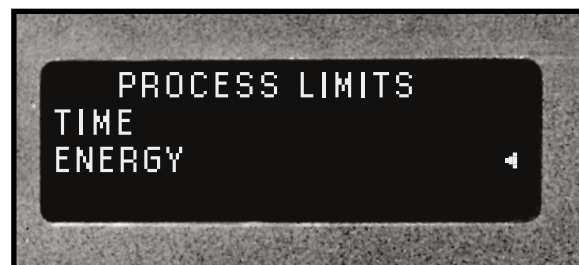

Figure 8–3 Single–Pressure Process Limits Menu

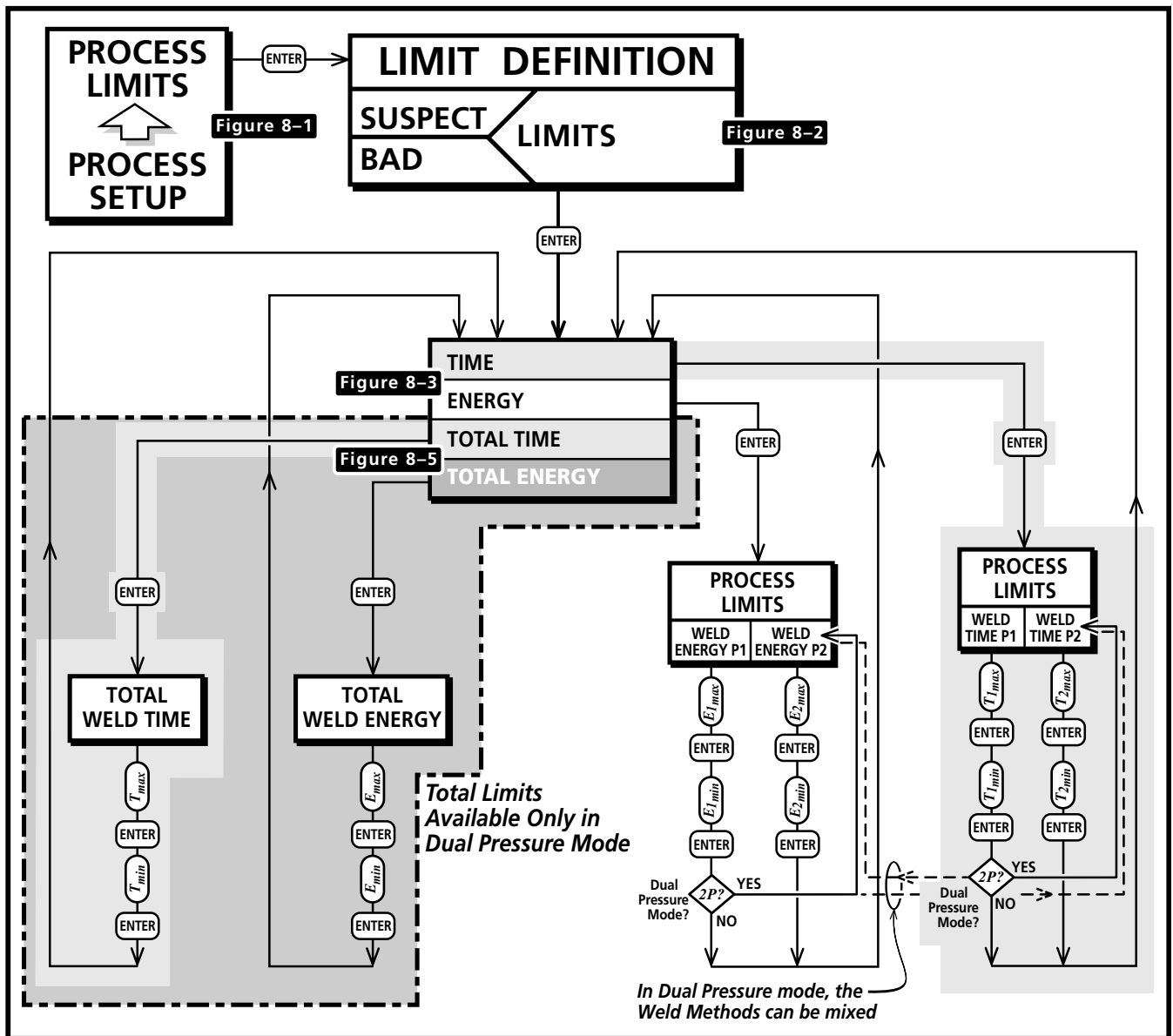

Figure 8-4 Limit Definition Flow Chart

For a dual-pressure mode, both the normal limits and the total limits are displayed as shown in Figure 8-5.

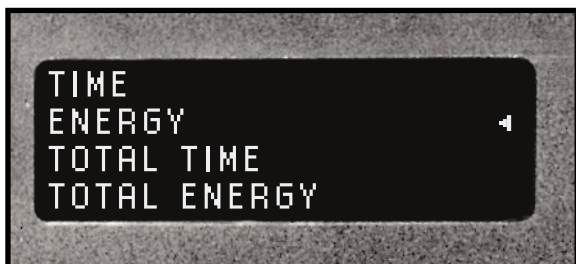

Figure 8-5 Dual-Pressure Process Limits Menu

In the flowchart, the single-pressure limits are on the right side and the dual-pressure total limits section are in the shaded area on the left side.

Single Pressure Mode

If a single-pressure mode has been programmed, the limits begin with the selection of Time or Energy in the Process Limits menu (Figure 8-3). Pressing the ENTER key displays the limit parameter selection which is shown in Figure 8-6.

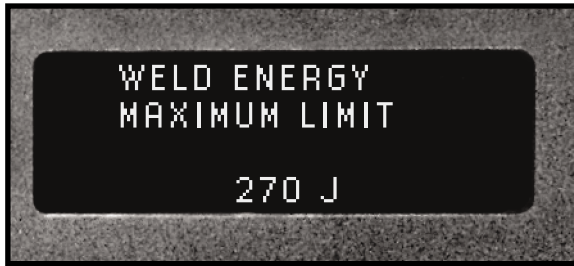

Figure 8-6 Single Pressure Max Energy Data Entry

After the minimum and maximum limit values have been entered, the display returns to the Process Limit menu shown in Figure 8-3. Logical comparison ensures that the minimum value is less than the maximum value before permitting the value to be entered. The error screen shown in Figure 8-7 appears briefly and returns to the minimum limit value entry screen. Reduce the minimum value or press the **CANCEL** key to step back to the maximum limit value entry screen and increase its value until the logical condition is satisfied.

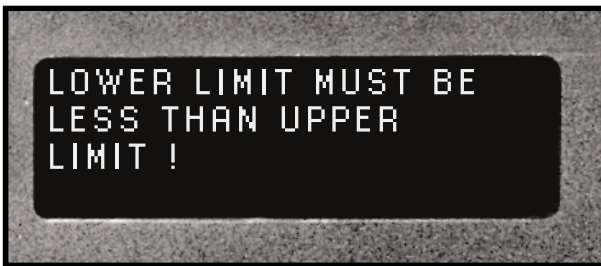

Figure 8-7 Minimum Value Error Message

After the minimum and maximum values have been entered, the display shows the Process Limits Menu (Figure 8-3). Press the **CANCEL** key to return to the Limit Definition Menu (Figure 8-2). Press **CANCEL** again to return to the Process Setup Menu (Figure 8-1).

Dual Pressure Mode

If a dual-pressure mode has been programmed, the limits selection also includes total values in the Process Limits menu (Figure 8-5). First choose one of the two top parameters by selecting either Time or Energy with the cursor. Pressing the **ENTER** key displays the limit parameter selection which is shown in Figure 8-8.

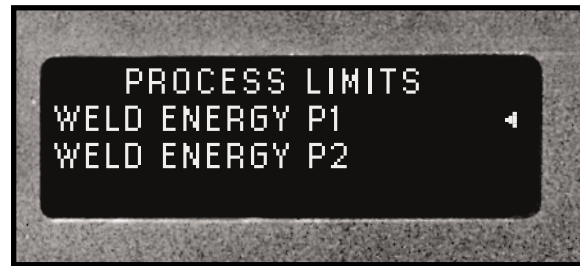

Figure 8-8 Dual-Pressure Limits Selection Menu

To detect a suspect or bad weld cycle, the minimum and maximum values for each pressure limit must be set. In dual-pressure mode, a logical decision function (indicated on the flowchart by the diamond with **2P?** inside), diverts the sequence after the P1 values have been entered and returns back to the limit selection menu for the P2 value. You must however move the cursor to the P2 limit before pressing **ENTER** otherwise you will return back through the P1 section. Pressing the **CANCEL** key will return you to the P1/P2 selection menu shown in Figure 8-8. The data entry screens for dual-pressure mode also identify the P1 or P2 pressure phase. The screen for entering the P1 Maximum Energy Limit is shown in Figure 8-9.

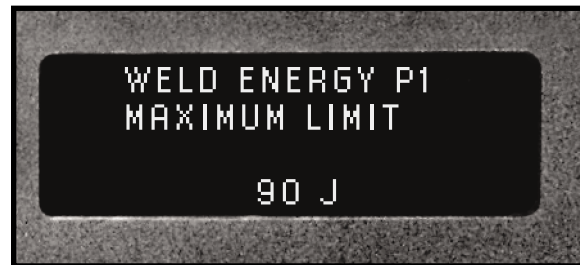

Figure 8-9 P1 Maximum Energy Data Entry

After the minimum and maximum limit values have been entered, the display returns to the Process Limit menu shown in Figure 8-5. Press the **CANCEL** key to return to the Limit Definition Menu (Figure 8-2). Press **CANCEL** again to return to the Process Setup Menu (Figure 8-1).

The return sequence flowchart for the **CANCEL** key is shown in Figure 8-10. Only the energy loops are labeled to avoid confusion, but the time loops have the same return sequence.

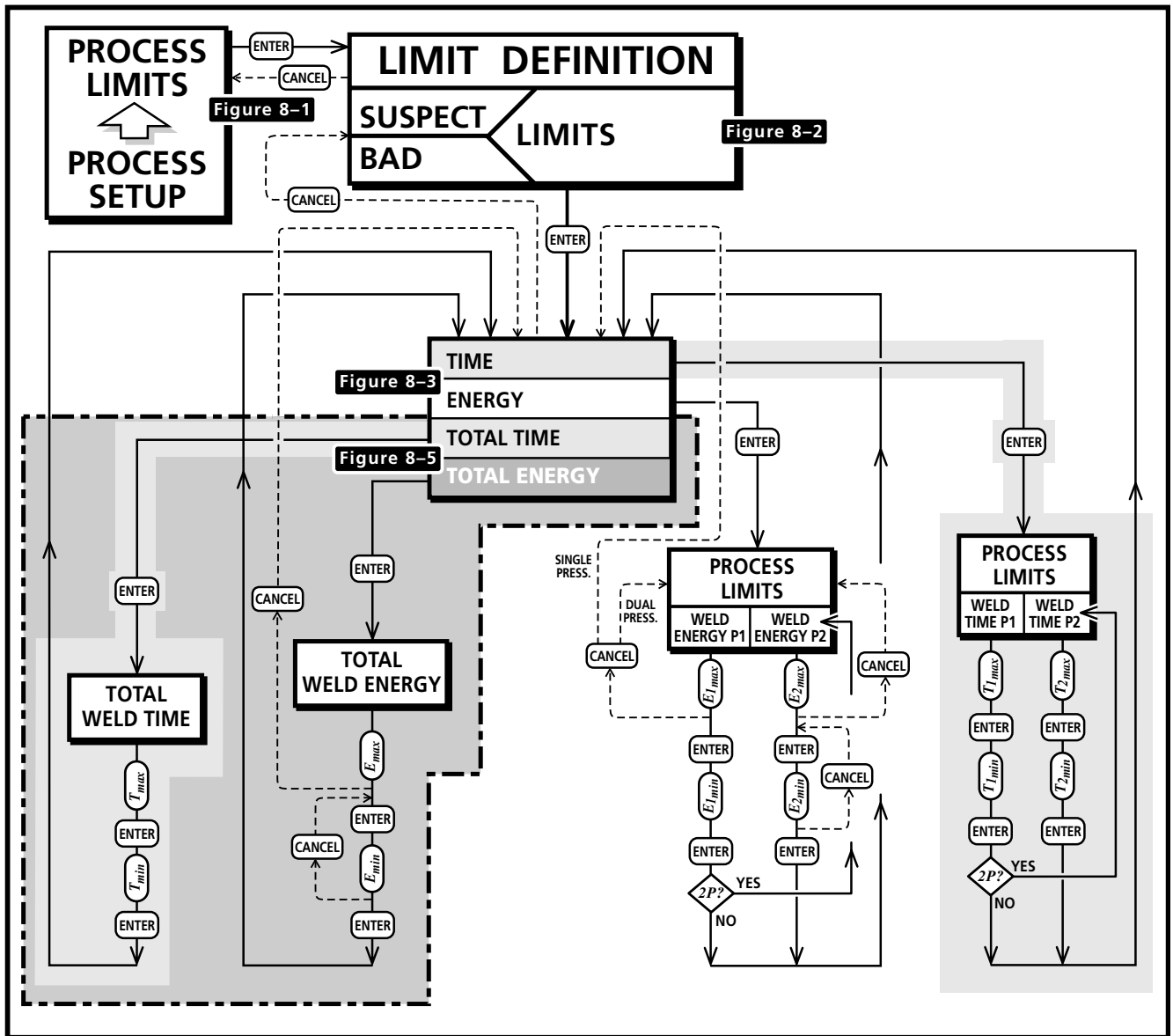

Figure 8-10 CANCEL Key Return Path Flow Chart

This page intentionally left blank

Utilities Menu

- Setup Utilities
- Part Count
- Status Outputs
- Cycle Press Off Line

Setup Utilities	97
Select Setup	98
Copy A Setup	99
Erase Setups	99
Part Count	100
Reset Part Count	100
Count Suspect/Bad Parts	100
Preset Part Count	101
Status Outputs	101
Cycle Press Off Line	101

This page intentionally left blank

Utilities Menu

The Utilities Menu is the third option from the main Process Setup menu. It is divided into four distinct menu groups:

1. SETUP UTILITIES
2. PART COUNT
3. STATUS OUTPUTS
4. CYCLE PRESS OFF LINE

The basic flowchart for the Utilities Menu was shown in Figure 6–7. A more detailed flowchart is shown below in Figure 9–1. Unlike the other two main menus, the four branches in the Utilities menu are unrelated and independent of each other. They only share a common thread of performing utilitarian functions.

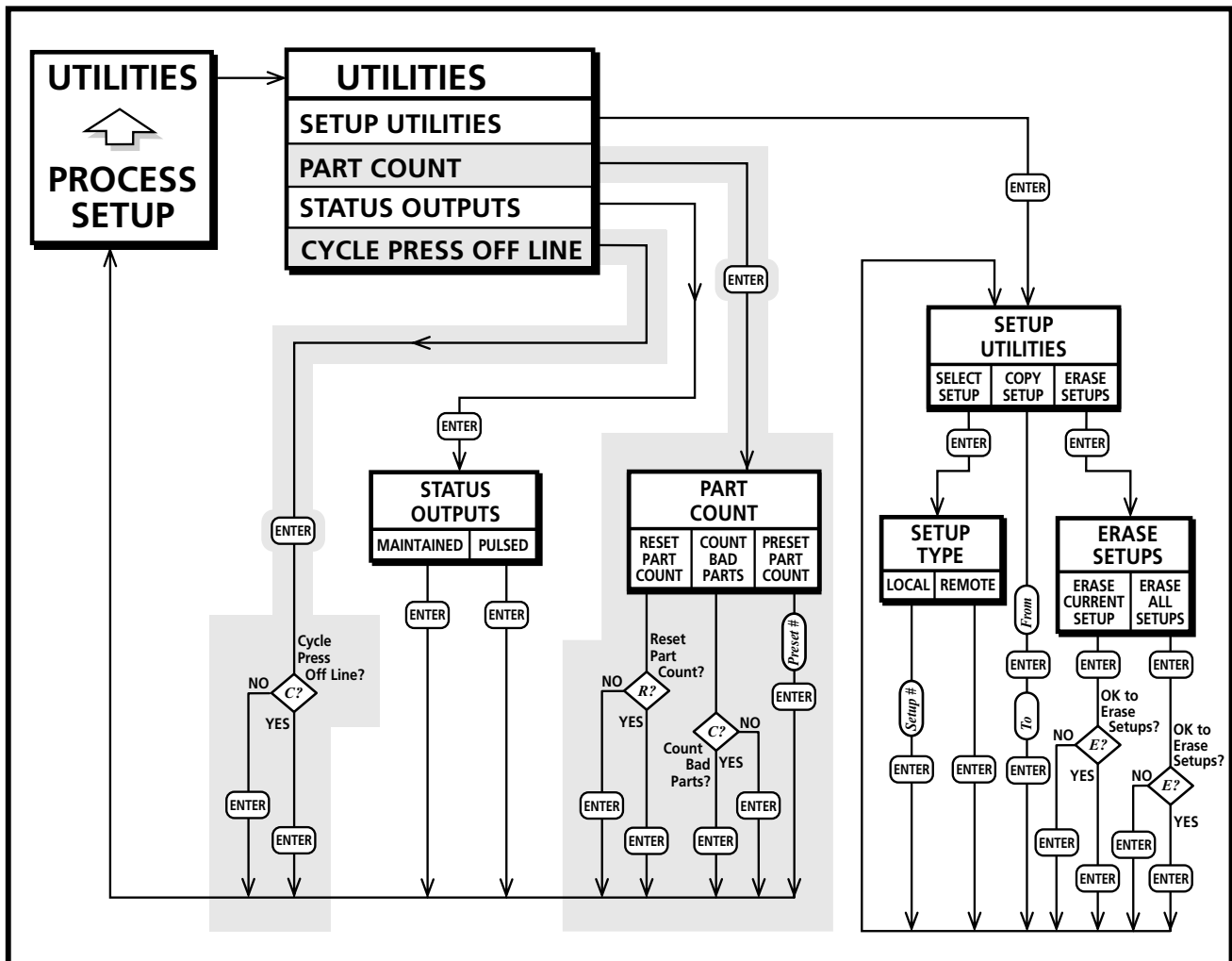

Figure 9–1 Utilities Menu Flow Chart

Setup Utilities

To access the Utilities menu, start from the Process Setup menu shown in Figure 9–2. Move the cursor down to select Utilities and press the ENTER key.

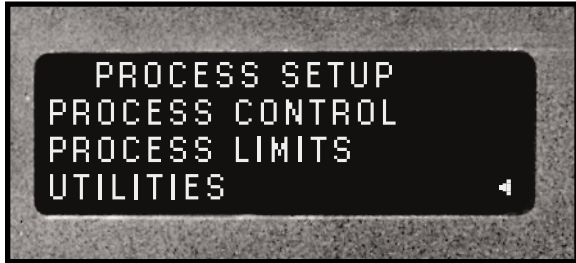

Figure 9–2 Process Setup Main Menu

The Utilities menu screen appears with four options listed. By default, the cursor is set to the top line which is Setup Utilities as shown in Figure 9–3.

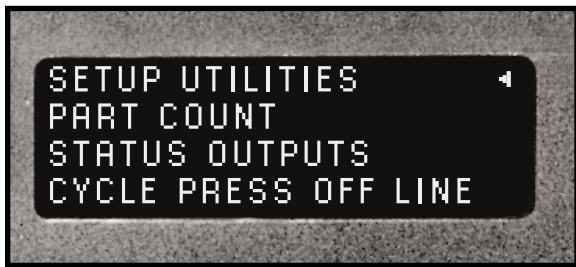

Figure 9–3 Setup Utilities Menu

Pressing the ENTER key moves to the next menu screen which is the Setup Utilities selection shown in Figure 9–4. Notice the first line is indented which means it is a menu title, not a selectable option. From this menu, we can choose to either select, copy or erase the setups.

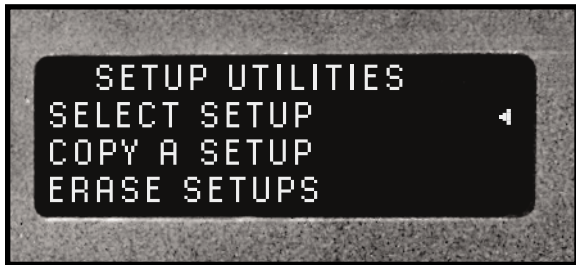

Figure 9–4 Setup Utilities Selection Menu

Select Setup

Pressing the ENTER key displays a decision menu from which you can enable either a local or remote setup control. This is shown in Figure 9–5.

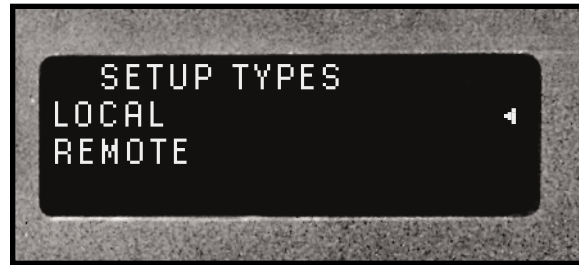

Figure 9–5 Setup Types Selection Menu

Press the ENTER key to display the setup entry screen which is shown in Figure 9–6. You can enter eight different setups named 1# to 8#. Use the increment (up arrow) and decrement (down arrow) keys to change the setup number.



Figure 9–6 Enter New Setup Menu

Pressing the ENTER key displays the Process Setup menu shown in here Figure 9–2 and earlier in Figures 7–5, 7–29 and 7–37. This enables you to begin modifying the setup information. If the setup has not been configured, a message briefly appears (Figure 9–7) before displaying the Process Setup menu. The flow follows the logic paths described in Section 7 – Process Control Menu.

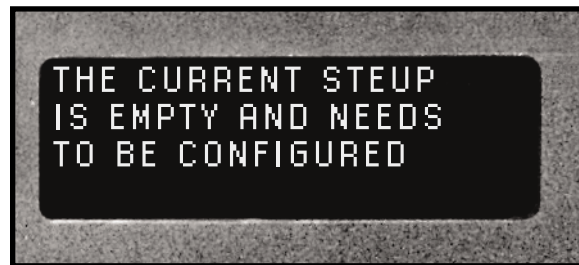

Figure 9–7 New Setup Configuration Message

If Remote setup is chosen, the PLC controls Remote Setup Selection Bits which determine which setup file is selected. The file number is determined by the Setup ID defined in Table 5—II.

Copy A Setup

Starting from the Utilities menu in Figure 9–4, move the cursor down to Copy A Setup and press the ENTER key. The display first requests the source file number. This is shown in Figure 9–8.

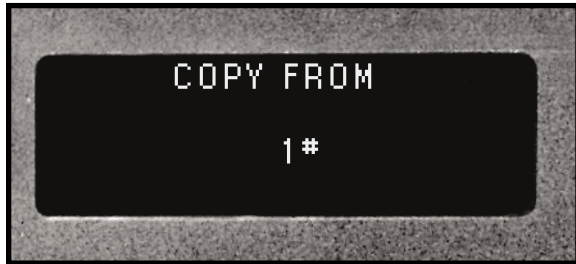

Figure 9–8 Source File Location Entry

Use the increment and/or decrement key to select a source file and press the ENTER key. Next the display requests a destination for the file as shown in Figure 9–9. Again, use the increment and/or decrement key to select a destination and press the ENTER key.

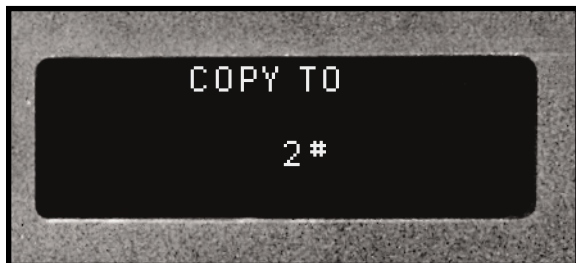

Figure 9–9 Destination File Location Entry

The display will ask for confirmation before proceeding. This screen is shown in Figure 9–10.

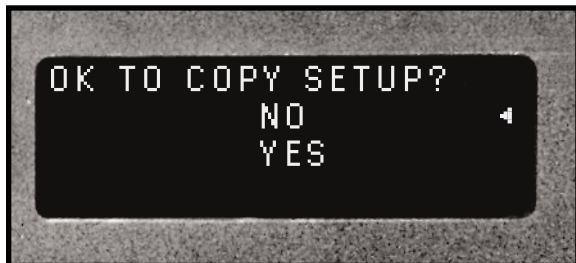

Figure 9–10 Confirm Copy Files

To proceed, move the cursor down to YES and press the ENTER key. The file is copied and the display returns to the Setup Utilities selection menu shown in Figure 9–4.

Erase Setups

Again, starting from the Utilities menu in Figure 9–4, move the cursor down to Erase Setups and press the ENTER key. The menu gives us a choice to erase the current setup or to erase all setups. This menu is shown in Figure 9–11.

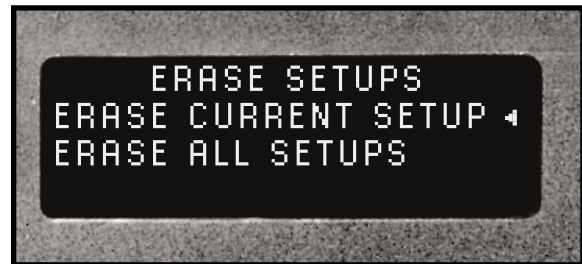

Figure 9–11 Erase Setups Selection Menu

The current setup is the one chosen from the Select Setup menu. Press the enter key, and the menu prompts you with a confirmation messages indicating the setup to be deleted. This is shown in Figure 9–12.

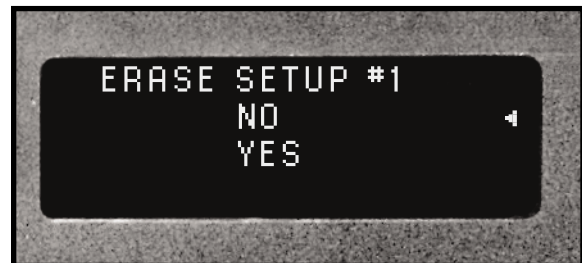

Figure 9–12 Confirm Erase Selected Setup

To erase the indicated setup, move the cursor down to YES and press ENTER. The display will display the message that the setup is being erased (Figure 9–13) and return to the Process Setup menu (Figure 9–2). Leaving the cursor at NO and pressing ENTER will still return you to the Process Setup menu (Figure 9–2).

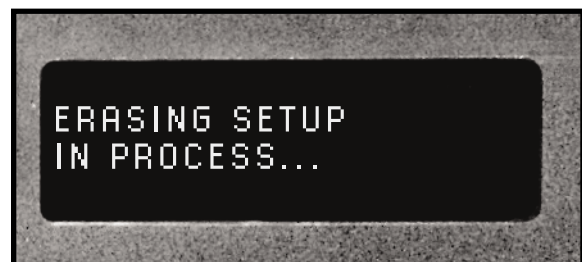

Figure 9–13 Erase Setup In Process

To erase all the stored setups, move the cursor from ERASE CURRENT SETUP (see Figure 9–11) to down to ERASE ALL SETUPS and press ENTER. A confirmation message is displayed. Move the cursor down to YES as shown in Figure 9–14. Press the ENTER key to delete the setup files.

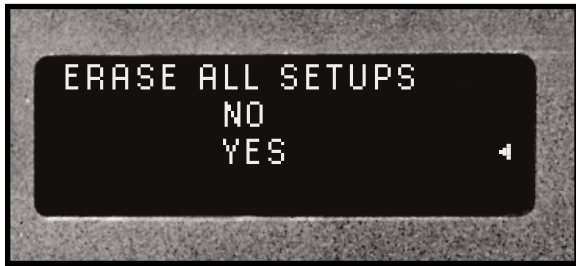

Figure 9–14 Confirm Erase All Setups

A progress message (see Figure 9–15) appears for about 8 seconds. When the process is complete, the display returns to the Process Setup menu as shown in Figure 9–2

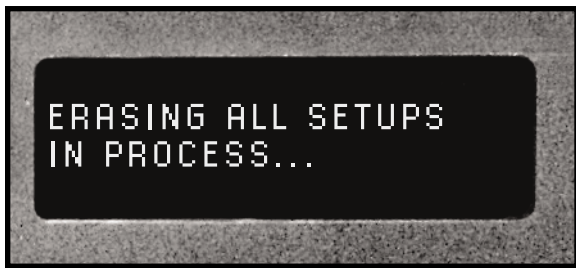

Figure 9–15 Erasing All Setups In Process

Part Count

The parts count option (see Figure 9–3) offers three options. The three choices are to reset the counter, count suspect/bad parts and preset the counter as shown in Figure 9–16.

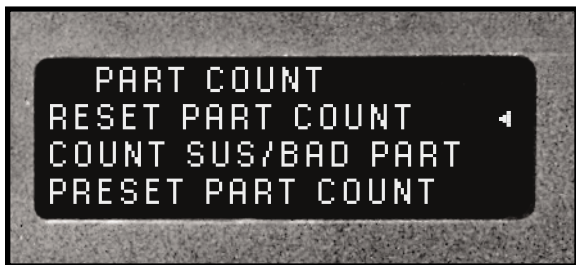

Figure 9–16 Part Count Selection Menu

The count replaces the - - - in the upper left of the operate screen (see Figures 7–3, 7–4, 7–31 and 7–53).

Reset Part Count

This function resets the parts counter back to zero. With the cursor at the reset function, press the ENTER key. The confirmation screen shown in Figure 9–17 is displayed next.

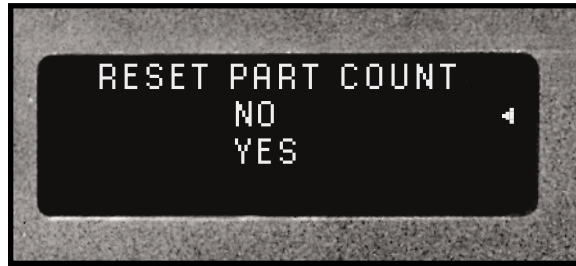

Figure 9–17 Confirm Reset Part Count

Use the decrement key to move the cursor down one line to YES and press the ENTER key. The counter will be reset and the menu returns to the part count selection menu shown in Figure 9–16.

Count Suspect/Bad Part

The second option controls the suspect/bad part counter. The counter can be set to count all parts or only the good parts. To configure the counter, move the cursor down to COUNT SUS/BAD PART (see Figure 9–16) and press ENTER. A confirmation screen (shown in Figure 9–18) is then displayed.

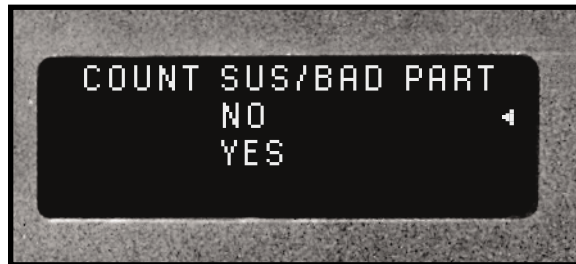

Figure 9–18 Confirm Counter Enabled

To count all parts, move the cursor to YES, press ENTER and the menu returns to the part count selection screen shown in Figure 9–16. To exclude bad/suspect parts, move the cursor to NO and press ENTER. The bad/suspect parts are ignored and only good parts are counted. The menu returns to the part count selection screen shown in Figure 9–16.

Preset Part Count

This option allows you to preset a value (maximum = 60,000) in the counter. Again from the part count selection menu, move the cursor to the bottom line next to PRESET PART COUNT and press ENTER. A data entry screen for presetting the value is displayed. Use the left and right arrow keys to select the digit position, and the up and down arrow keys to increment or decrement the value.

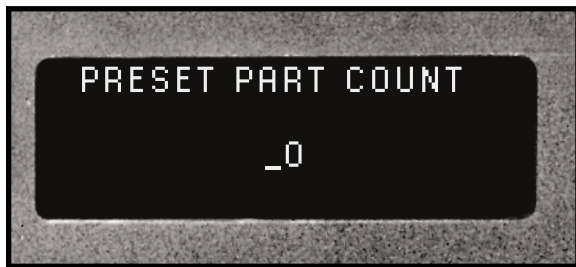

Figure 9-19 Counter Preset Value

The underscore indicates the digit position which is initially under the right-most digit. To preset the counter, press ENTER and you are returned to the part count selection menu shown in Figure 9-16.

Status Outputs

The third option in the Utilities Menu (see Figure 9-3) is Status Outputs. Moving the cursor down to Status Outputs and pressing the ENTER key displays the Status Output Selection menu.

This menu option permits you to set the four Isolated Status Outputs as either maintained or pulsed. The default setting is maintained. If the output is set to pulsed, the output pulse width is 100 msec. The status output selection menu is shown in Figure 9-20. To change the mode, move the cursor to PULSED and press ENTER.

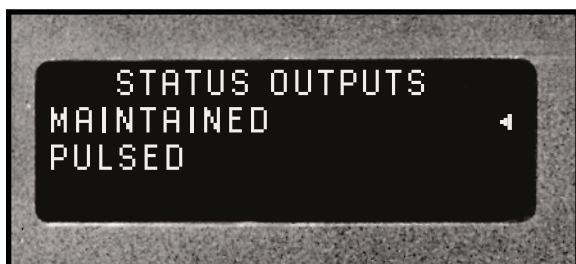

Figure 9-20 Status Output Mode Selection

The four outputs controlled by this menu are:

1. Isolated Bad Part on Pin 20
2. Isolated Good Part on Pin 21
3. Isolated Ready on Pin 22
4. Isolated In-Dwell on Pin 23

For a complete description of each signal, refer back to Table 5—IV.

Cycle Press Off Line

The last option in the Utilities Menu (Figure 9-3) is Cycle Press Off Line. To access this option move the cursor down to the last line and press ENTER. This subsequent menu is shown in Figure 9-21.

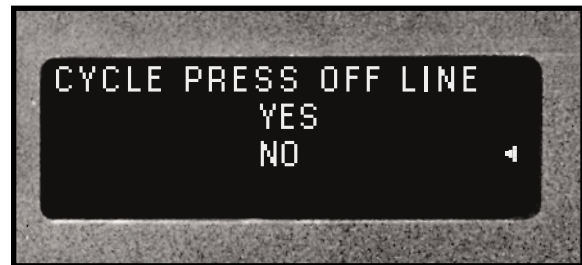

Figure 9-21 Cycle Press Selection Menu

This option works only with the palm operate switches on the press base. When the DPC front panel status is set OFF LINE, it cannot be triggered to cycle the press. During testing or fixture setup, it may be necessary to cycle the press without producing an ultrasonic output signal. This menu option permits cycling the press with the DPC set to OFF LINE. To enable this menu option, move the cursor key up one line to YES and press the ENTER key. The press can now be cycled by pressing both palm activation switches, without producing an ultrasonic output signal. An Automation Input signal (pin 8 of J902) will not cycle the press with this menu option with the DPC set to OFF LINE.

This page intentionally left blank

Probes & Probe Stacks

- Theory of Operation
- Probe Configuration
- Probe Stack Assembly
- Booster Notes
- Probe Stack Mounting

The Ultrasonic Probe	105
Theory of Operation	105
Probe Configuration	105
Ultrasonic Horn	106
Booster	106
Stack Assembly	107
Installing Replaceable Tips	107
Mounting Stud to Horn/Booster	108
Horn to Booster	109
Booster to Probe	109
Horn to Probe	109
Torque Unit Conversion Chart	110
Stack Disassembly	111
Booster Notes	114
Stack Mounting	115

This page intentionally left blank

The Ultrasonic Probe

Theory of Operation

Plastic welding is the most common application of ultrasonic assembly. To perform ultrasonic plastic welding, the vibrating tip is brought into contact with one of the work pieces. Pressure is applied and ultrasonic energy travels through the material generating frictional heat at the contact point of the two parts. The frictional heat melts a molded ridge of plastic on one of the pieces and the molten material flows between the two surfaces. When the vibration stops, the material solidifies forming a permanent bond.

Probe Configuration

A basic ultrasonic probe package consists of —

1. A probe which houses the transducer to convert the electrical energy supplied by the generator into mechanical vibrations.
2. A horn to transfer the mechanical vibrations from the probe to the parts to be welded.

Optional components include special replaceable tips which can be threaded on to the tip of the horn, and a booster to amplify the mechanical vibrations of the horn. A basic hand-held probe system is shown in Figure 10–1. The hand probe is easily identified by its trigger actuator and permanently attached cable. Normally a booster is not used with a hand probe as this increases the length and weight and reduces its versatility. The optional threaded titanium tip can be used when the application calls for a staking profile or a pointed spot weld. Replaceable tips are not commonly used in high-volume production environments.

A mounted probe lacks the trigger actuator and has a HV–BNC connector for attaching the high voltage coaxial cable. A mounted probe may also have a booster to change its output amplitude.

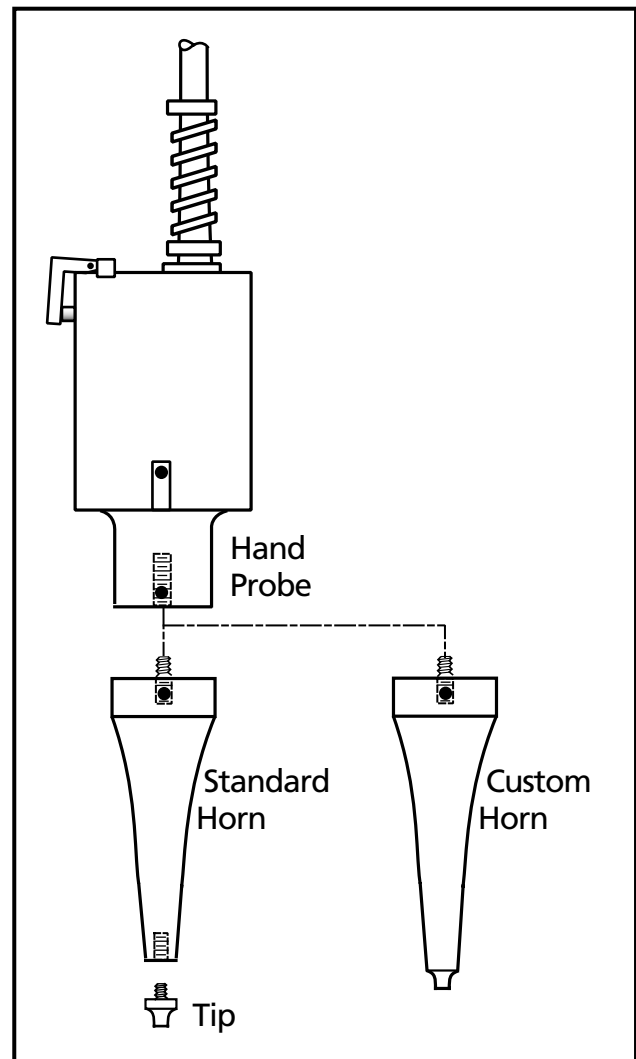

Figure 10–1 Hand Probe, Horn and Tip

Ultrasonic Horn

The horn transfers the ultrasonic mechanical vibrations (originating at the transducer in the probe housing) to the plastic parts through direct physical contact. The horn is precision machined and designed to vibrate at either 20kHz, 30kHz, 40kHz, 50kHz or 70kHz. The tuning is accomplished using electronic frequency measurement. Inherent variations in material composition prevent tuning by dimensional machining alone.

There are many different horn profile styles depending upon the process requirements. Factors which affect the horn design are the materials to be welded and the method of assembly. Horns are usually constructed from aluminum, hardened steel or titanium. As the frequency increases, vibration amplitude typically decreases, but internal stress in the horn increases. Higher frequencies are used for delicate parts that cannot handle a lot of amplitude. Some factors to keep in mind for high-frequency (e.g. 40kHz) ultrasonic welding versus low-frequency (e.g. 20kHz) ultrasonic welding are listed here.

1. Stress in the horn is higher at high frequencies.
2. Wear on the horn is greater at high frequencies.
3. Clean and flat mating surfaces between the horn, booster and transducer are more critical at high frequencies.

Booster

The function of a booster is to alter the gain (i.e. output amplitude) of the probe. A booster is amplifying if its gain is greater than one and reducing if its gain is less than one. A neutral or coupling booster is used to provide an additional clamping location for added probe stack stability. A probe designed to be mounted in a fixture along with a booster and horn is shown in Figure 10–2. This is commonly referred to as a stack. As indicated, the components are secured with threaded studs.

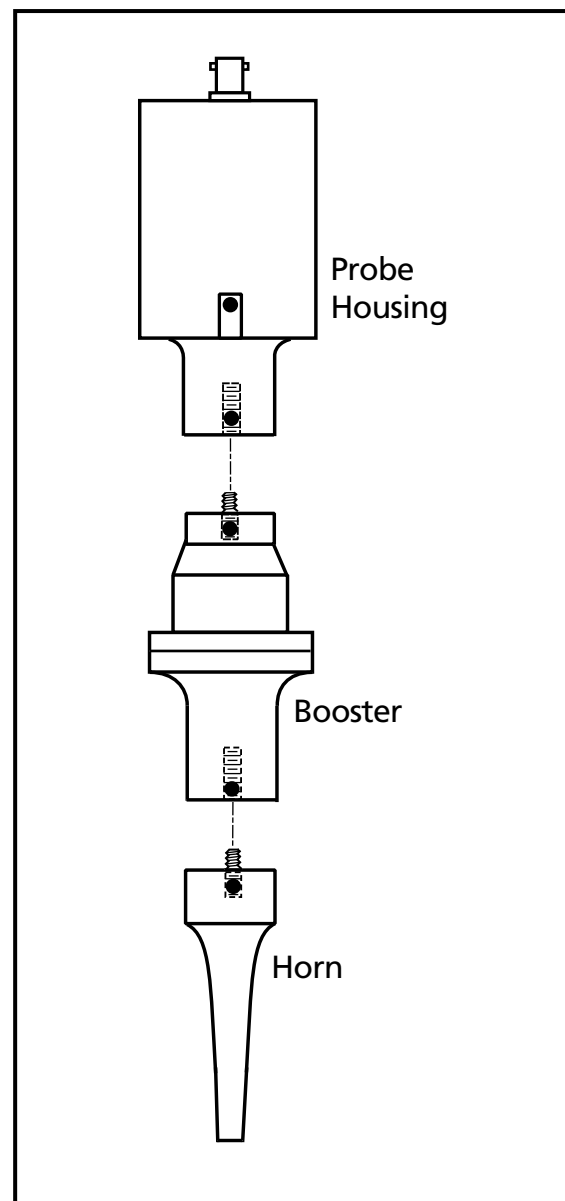

Figure 10–2 Probe, Booster and Horn

Stack Assembly

Attaching A Replaceable Tip To A Horn

1. Inspect all horn and tip surfaces for stress cracks, chips, or gouges. Any of these irregularities will affect operation and could lead to further equipment damage. Contact the Dukane Ultrasonics Tooling Department concerning damaged horn components.
2. Apply an extremely thin layer of a high temperature, high pressure silicon grease to the back surface that mates with the horn. The grease will allow both surfaces to intimately mate and become acoustically transparent which improves the energy transfer. Do not apply any grease to the threads. We recommend Dow–Corning #4 (or #111 as an alternate). A small packet of Dow–Corning #4 is supplied with the system. If you cannot use a silicon–based grease in your facility, a petroleum–based grease may be used. However, it is likely to leave carbonaceous deposits on the surface, and require more frequent joint maintenance. Failure to follow these instructions, may result in the mating surfaces bonding and difficulty removing the tip from the horn.
3. Thread the tip into the horn and tighten to the torque specifications below using an open end wrench of the correct size to fit the wrench flats of the tip. This is illustrated in Figure 10–3. If necessary, use a spanner wrench (on horns with spanner wrench holes) or an open end wrench (on horns with wrench flats) to keep the horn from turning in your hand. A canvas strap wrench is permissible if it does not gouge or scratch the horn.
 - 70 inch-lbs for an 8mm threaded tip
 - 100 inch-lbs for a 3/8" x 24 threaded tip
 - 160 inch-lbs for a 1/2" x 20 threaded tip

NOTE

Do not apply any grease to the threads of the replaceable tip. This may cause the tip to loosen from the horn resulting in inconsistent operation.



CAUTION

NEVER clamp the horn in a vise. The resulting scratches or gouges in the surface are stress risers which may result in cracks.

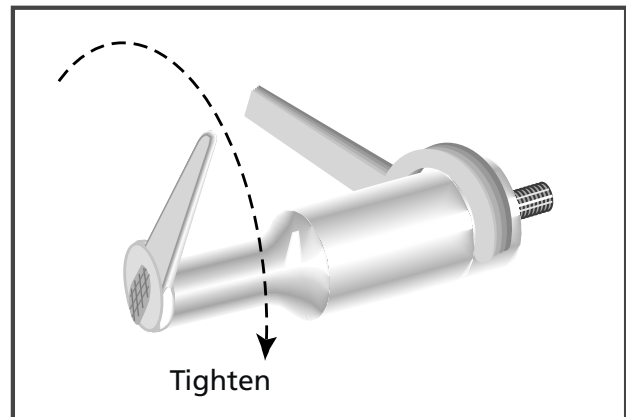

Figure 10–3 Replaceable Tip Installation

NOTE

Dukane Part No for the 20kHz spanner wrenches is 721–68

Dukane Part No for the 40kHz spanner wrenches is 721–44

Attaching The Mounting Stud To A Horn Or A Booster

1. Inspect the stud for cracks or damaged threads. Replace the stud if it is cracked or otherwise damaged.
2. Remove any foreign matter from the threaded stud and the mating hole.
3. Thread the mounting stud into the input* end of the horn or the input* end of the booster and tighten to the following torque specifications using an allen wrench in the socket head of the mounting stud. Table 10—I lists the torque specifications in units for both English and Metric systems of measurements. Figure 10–5 is a handy conversion graph if you require intermediate values not listed in the tables.

DO NOT hold the booster by the mounting rings when tightening stud. The mounting rings have a shear pin which could snap under excessive torque. Use a spanner wrench (on horns with spanner wrench holes) or an open end wrench (on horns with wrench flats) to keep the horn or booster from turning in your hand.

- 70 inch-lbs for an 8mm threaded stud
- 100 inch-lbs for a 3/8" x 24 threaded stud
- 160 inch-lbs for a 1/2" x 20 threaded stud

inch-lbs	ft-lbs	N-m
70	5.8	7.9
100	8.3	11.3
160	13.3	18.1

Table 10—I Stud Torque Unit Conversions

* Always assemble the mounting studs that mate boosters, transducers and horns to the input end of the horn or the input end of the booster first. This is shown in Figures 10–6 and 10–7.

NEVER thread a stud into the transducer or the output end of the booster first. See *Booster Notes* in this section for correctly identifying the output end of a booster.

NOTE

Do not apply any grease to the stud threads or the tapped hole. This may cause the stud to loosen. If the stud wanders within the joint, it can vibrate, resulting in excessive heat. In some cases, this can melt the tooling material.

NOTE

To convert inch-lbs to ft-lbs, divide by 12
 To convert inch-lbs to Nm, divide by 8.852
 To convert ft-lbs to Nm, multiply by 1.356
 To convert Nm to ft-lbs, multiply by 0.7376

Torque specifications have a tolerance of about ± 10%.

See Figure 10–4 for a handy conversion graph.

Attaching The Horn To A Booster, Booster To A Probe, Or Horn To A Probe

1. Inspect all surfaces to be joined for stress cracks, chips, or gouges. Any of these irregularities will affect operation and could lead to further equipment damage. Contact the Dukane Ultrasonic Tooling Department concerning a damaged booster.
2. Ensure that the mating surfaces of the two components are clean and smooth. These surfaces must make intimate contact for the mechanical energy to pass from one component to the next. Pitting or a buildup of old grease and dirt on a mating surface will interfere with the energy transfer and reduce the power delivered.
3. Make sure that the stud in the horn or booster is tight. See the preceding mounting stud assembly instructions for torque specifications.
4. Remove any foreign matter from the threaded stud and mating hole.
5. Apply an extremely thin layer of a high temperature, high pressure silicon grease to the surface that mates with the horn. The grease will allow both surfaces to intimately mate and become acoustically transparent which improves the energy transfer. We recommend Dow–Corning #4 (or #111 as an alternate). A small packet of Dow–Corning #4 is supplied with the system. If you cannot use a silicon–based grease in your facility, a petroleum–based grease may be used. However, it is likely to leave carbonaceous deposits on the surface, and require more frequent joint maintenance. Grease may be omitted if mylar washers are preferred on systems that require frequent changes. Mylar is plastic and will creep under compression, so mylar is not recommended for system that are not changed frequently. Failure to follow these instructions, may result in the mating surfaces bonding and difficulty re-

NOTE

Always remove a probe stack from the machine in which it is mounted before attaching or removing a horn.

CAUTION



Never leave a horn or booster assembly hand tight. Torque it to the proper specifications before proceeding. If the assembly is installed without being properly torqued down, the assembly may vibrate severely, damaging the mating surfaces and causing the generator to overload.

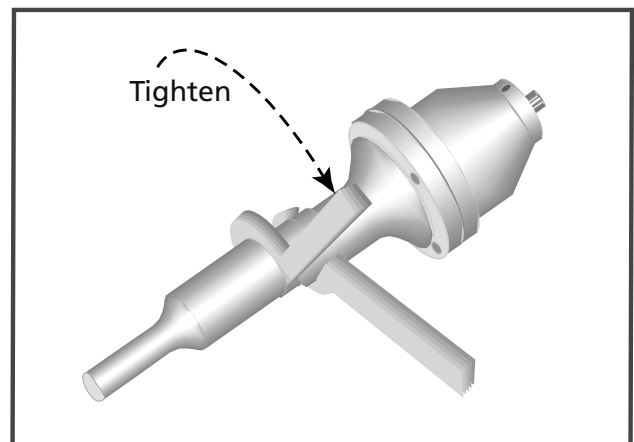

Figure 10–4 Stack Assembly Procedure

moving the horn from the booster or the booster from the probe.

6. Thread the components together and tighten to the following torque specifications using only the correct size wrenches. Use spanner wrenches on components with spanner wrench holes or an open end wrench on components with wrench flats. See Figure 10–4 for the correct procedure. Refer to Table 10—II for torque units conversions. Be careful not overtighten.

- 40kHz Stacks - 130 inch-lbs
- 20kHz Stacks - 200 inch-lbs

inch-lbs	ft-lbs	N-m
130	10.8	14.7
200	16.7	22.6

Table 10—II Horn/Booster Torque Unit Conversions

NOTE

Horn and booster torque specifications are higher than stud torque specs. Be sure to tighten the horn or booster joints to the higher torque limits.

Do not tighten the studs to these higher ratings as it may induce unnecessary stress in the assembly.

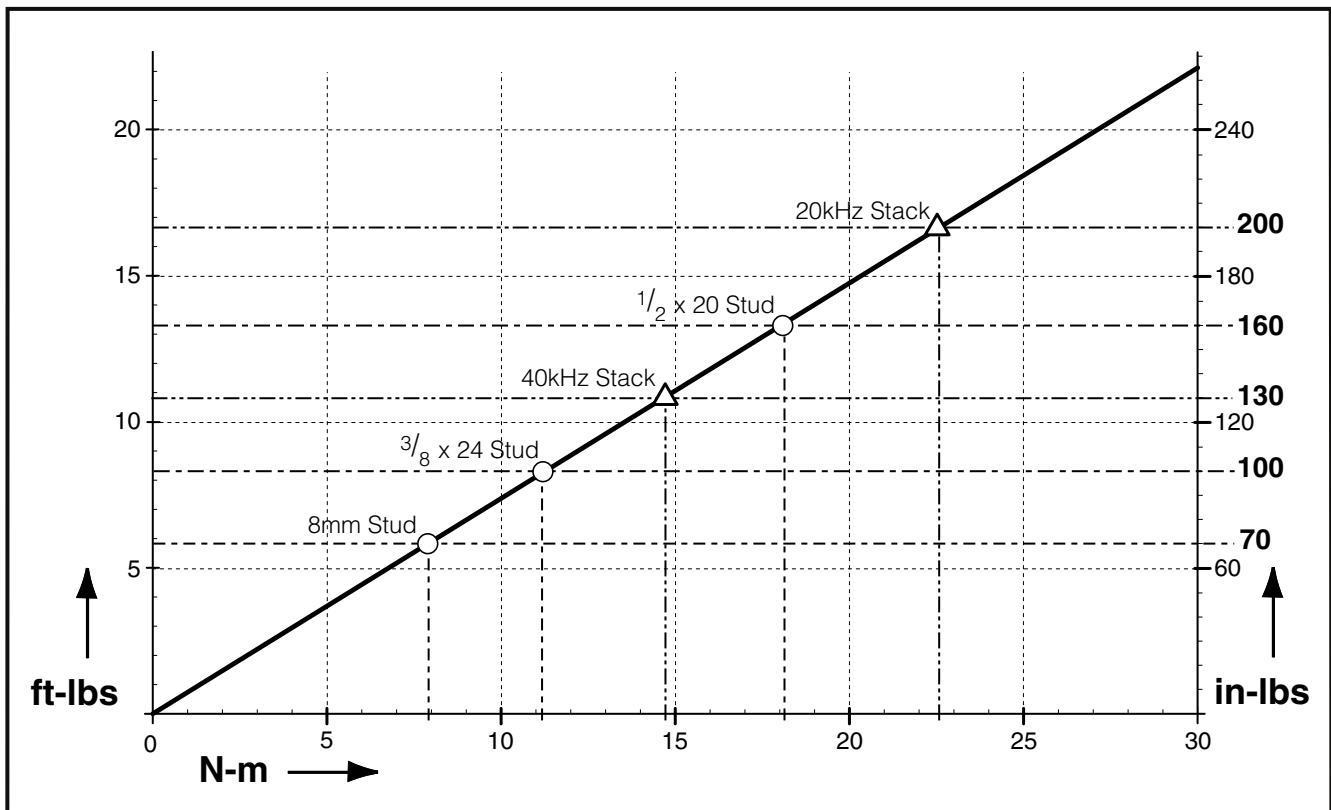



Figure 10-5 Torque Value Conversion Graph

Stack Disassembly

Stack disassembly is required when changing the booster or horn, or for a thorough inspection of all stack components. In mounted systems, always remove the stack from its mounting to disassemble the stack components.

To establish a maintenance schedule, inspect the mating surfaces after the first 200–400 hours of operation. If they require cleaning (see Probe Maintenance in Section 13), halve the time between inspections. If the surfaces do not require reconditioning, then double the time between inspections. Each system is different due to the large number of operational parameters and stress factors.

CAUTION



Never hold a probe by the housing when tightening or loosening an adjoining component. The probe housing has anti-rotation devices to keep the transducer aligned. These could shear under excessive torque.

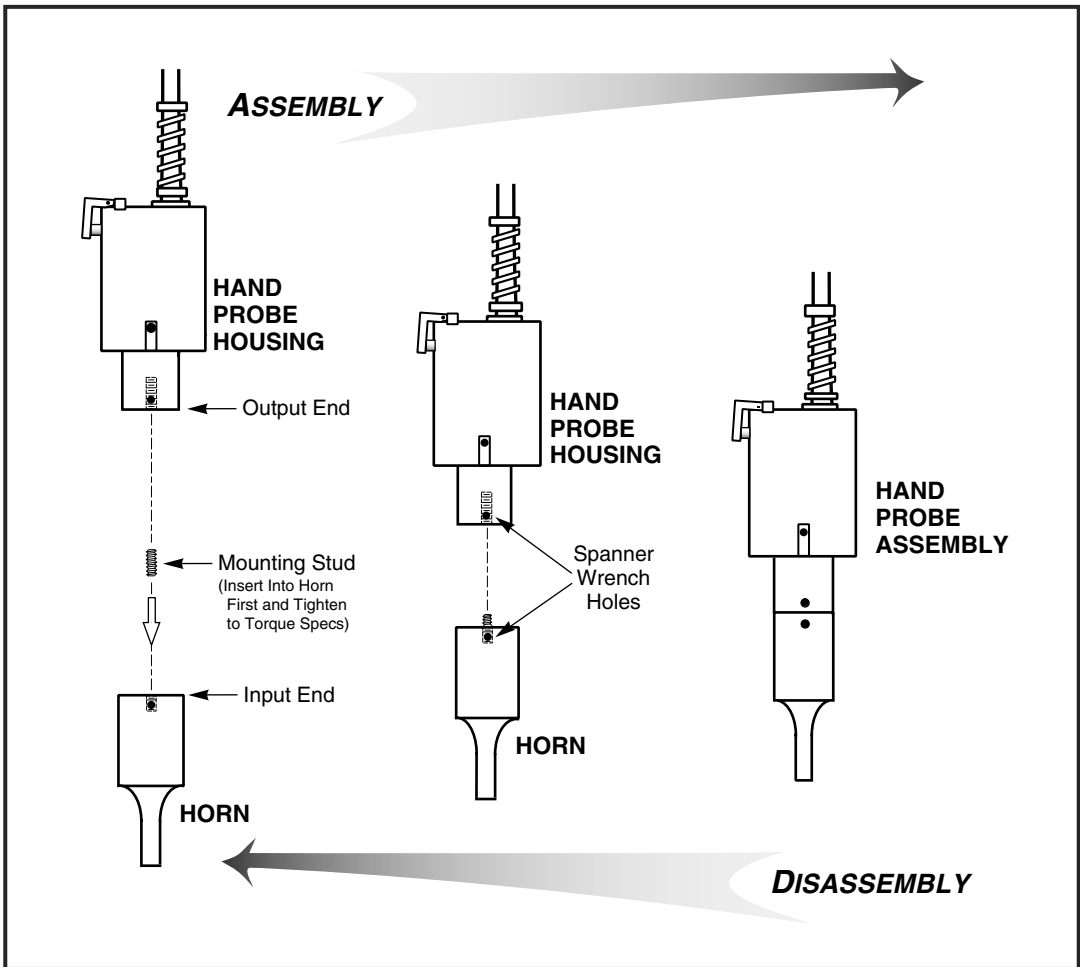



Figure 10-6 Hand Probe Assembly and Disassembly

The assembly and disassembly procedures for a hand probe shown in Figure 10–6. The same procedure for a probe stack with booster is shown in Figure 10–7. It makes no difference whether the horn is attached to the booster first, or the booster is attached to the probe first.

CAUTION



Never hold a probe by the housing or a booster by the mounting rings when tightening or loosening an adjoining component. The probe housing and booster rings have anti-rotation devices to keep the transducer and booster aligned and could shear under excessive torque.

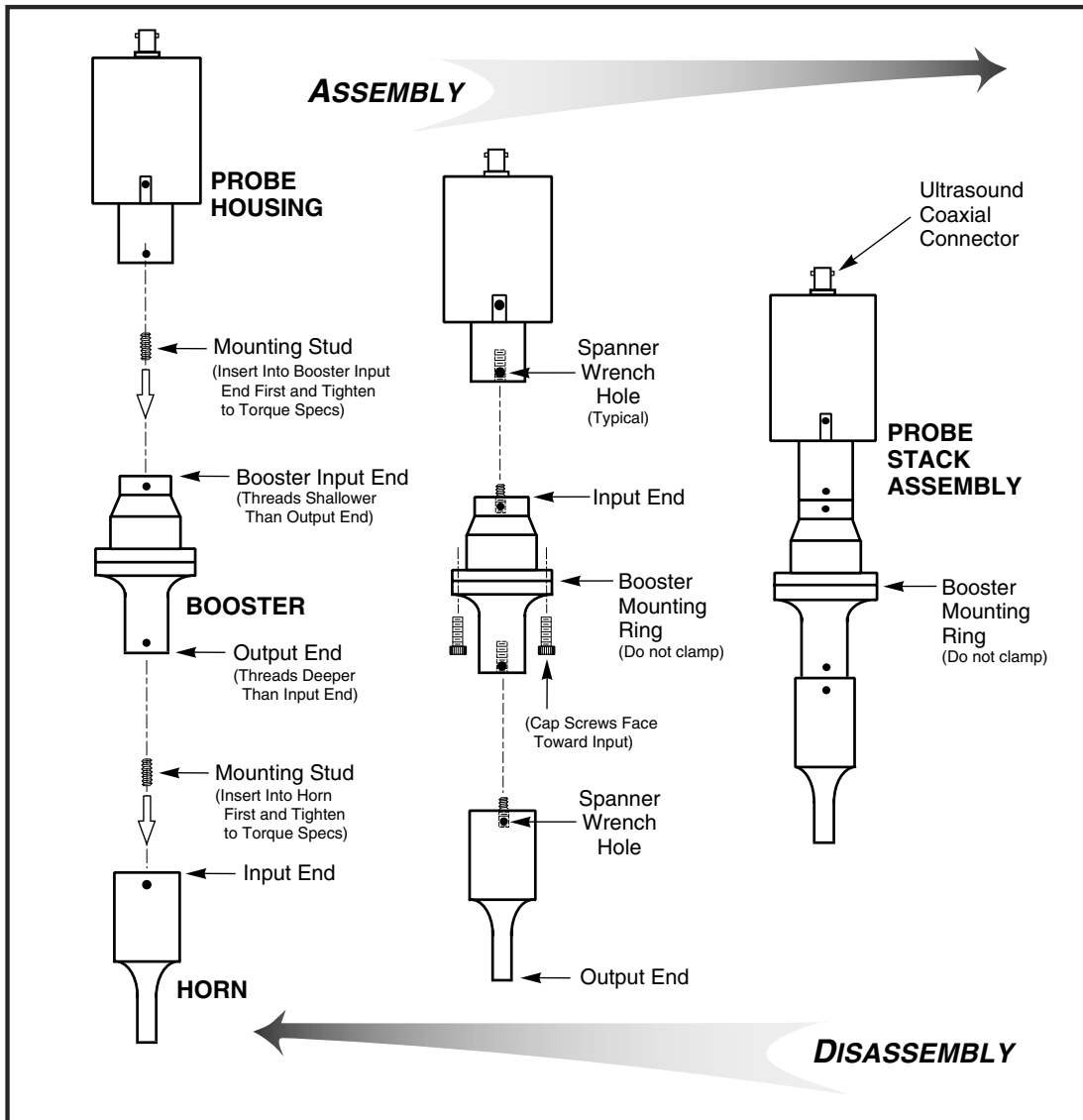

Figure 10–7 Probe Stack with Booster Assembly and Disassembly

Separating The Horn From A Booster, Booster From A Probe Or Horn From A Probe

On all transducers and horns with spanner wrench holes (see Figures 10–8), use only the correct size spanner wrench that came with your system to provide sufficient torque to loosen a joint.

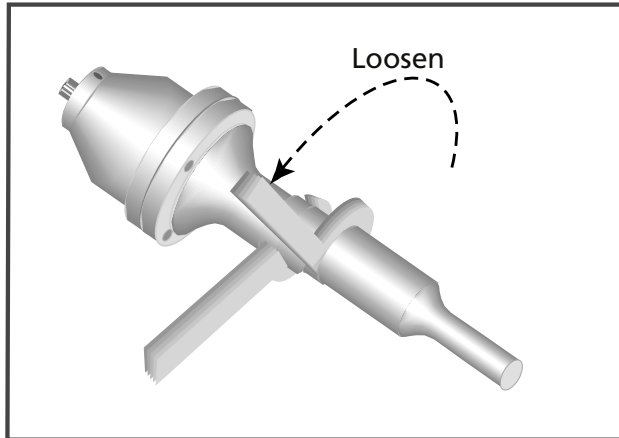

Figure 10–8 Separating The Horn From The Booster

On boosters and horns with wrench flats, use only the correct size wrench to provide sufficient torque to loosen a joint when necessary.

Removing The Mounting Stud From A Horn Or Booster

Only use an allen wrench of the correct size in the socket head of stud to remove the stud from the horn or booster.

Removing Replaceable Tips From A Horn

Use an open end wrench of the correct size to fit the wrench flats of the detachable tip. Use a spanner wrench (on horns with spanner wrench holes) or an open wrench (on horns with wrench flats) to provide an opposite force and keep the horn from turning in your hand. Refer to Figure 10–9 for the correct tip removal procedure.

CAUTION



NEVER clamp a horn or booster in a vise. The resulting scratches or gouges in the surface are stress risers which may result in cracks.

Dukane has a stainless steel tool vise (Part No.UFTV20) for clamping 20kHz boosters and transducers to facilitate disassembly of stubborn components without damage. It accepts front slug and booster tooling diameters of 1.5 and 1.81 inches and has replaceable anti-rotation pins.



NOTE

Do not hold a booster by the mounting rings when removing the stud from the booster. Use a spanner or open-end wrench to provide opposite force and keep the horn or booster from turning in your hand when loosening the stud. Use a spanner wrench on horns and boosters with spanner wrench holes. Use an open end wrench on horns and boosters with wrench flats.

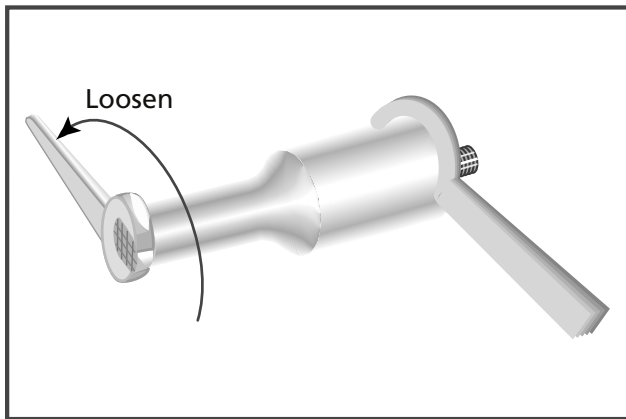

Figure 10-9 Removing A Replaceable Tip From The Horn

Booster Notes

How To Tell The Booster Input End From The Output

1. The depth of the threaded hole on the output end is always deeper than the threaded hole on the input end.
2. On an amplifying booster (gain > 1.0), the larger diameter end is the input end. On a reducing booster (gain < 1.0) the larger diameter end is the output end. On a neutral acting booster the diameters are equal.
3. The cap screws on the booster mounting rings are always inserted from the output end toward the input end (see Figure 10-7).

How To Tell If The Booster Is Amplifying Or Reducing

Boosters have a die-stamped number on their surface that indicates their gain or reduction. If the number is greater than 1.0 (e.g. 1.5), it is an amplifying booster. If the number is less than 1.0 (e.g. 0.6), it is a reducing or reverse booster. A neutral booster has no gain and has 1.0 stamped on it. A neutral or coupling booster is used to provide another probe stack clamping location for added stability.

CAUTION



NEVER install a booster upside down to change an amplifying system to a reducing system. The boosters are dimensionally asymmetric. They are tuned from input to output to act like an acoustic lens. Reversing them will not give the expected results and may cause damage to the system.

Mounting The Stack

A probe-horn assembly or probe-booster-horn assembly (stack) can be mounted into a customer-provided machine to ensure stability and proper alignment during operation or for automated operation. A stack is secured in a machine by clamping the probe (and booster, when present) at designated locations. Clamping at these designated locations provides stability to the stack and at the same time does not interfere with the transmission of ultrasonic vibrations of the stack components. The following rules apply when mounting a probe system stack.

1. A probe may be clamped anywhere along its body (except the 41S30). If it has a side mounted BNC, then it may require a thin mounting ring if it is to be clamped near the top. It may also be clamped below the BNC connector.
2. Secure a probe-horn stack by clamping the probe in two places.
3. Secure a probe-booster-horn stack by clamping the probe in one place and the booster in one place.
4. Never clamp the horn.

NOTE

Never hold a probe by the housing or booster by the mounting rings when tightening or loosening from an adjoining component (see Figures 10–6 and 10–7 to identify these parts). Always use the proper spanner wrenches when tightening or loosening the horn or booster.

This page intentionally left blank

DPC Checkout

- Startup & Self-Test
- System Test
- Probe Operation
- Stopping the Weld Cycle

Startup and Self-Test	119
System Test	120
System Operation	121
Stopping the Weld Cycle.....	121
Manual Systems	121
Automated System	121
End of Day	121

This page intentionally left blank

Startup and Self-Test

1. Push the rear panel AC breaker switch to the **ON** position (see Figure 3–3 or 3–9 for the switch location.)
2. Push the front panel AC power switch to the **ON** position (marked **I** on the switch.) This is labeled **A** in Figure 11–1.

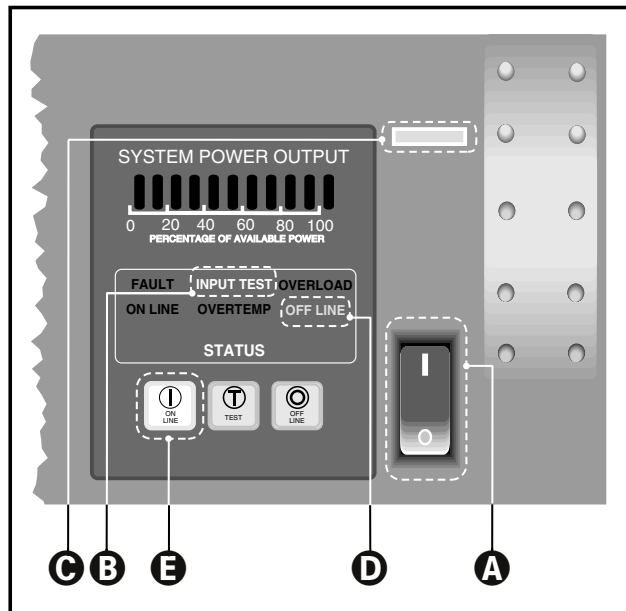

Figure 11–1 Front Panel Startup Controls and Indicators

3. The **INPUT TEST** indicator in the Status Display (**B**) flashes red for 5 to 10 seconds. This indicates the power-up self test is running. When the test has successfully completed, the **INPUT TEST** indicator goes dark.
4. The green power indicator (**C** in Figure 11–1) should then light up. The yellow **OFF LINE** status indicator (**D** in Figure 11–1) should also be lit. After subsequent power cycles, the DPC will return to its last state (**ON LINE** or **OFF LINE**) when the front panel AC power switch is turned **ON** again.
5. Press the **ON LINE** generator control key on the front panel (labeled **E** in Figure 11–1.) The green **ON LINE** indicator in the Status Display (labeled **F** in Figure 11–2) should now be lit.

NOTE

If either of the AC Breakers open, they will flip the switch to its Off position marked by the **O**.

NOTE

If the **INPUT TEST** indicator does not flash, check the AC line input. Both the rear panel and front panel AC breaker switches must be in the **ON** position, and the DPC line cord must be properly connected to a live AC outlet.

If the **INPUT TEST** indicator flashes and then remains in a steady red state –

1. The AC line level may be out of specified operating range.
2. The DPC may have an internal fault preventing normal operation.

NOTE

If a Press Control module is installed, and the **ON LINE** and **OFF LINE** indicators do not light, check the following items.

1. A Press Base cable (P/N 200–1124) must be connected to J35 on the press and J902 on the DPC (Cable 3 in Figure 3–8).
2. The Emergency Stop switch must be in its reset position (pulled out).
3. In place of a press cable, a jumper block (Dukane P/N 200–1293) can be installed on J902 (see Figure 3–4).

DPC System Test

To test the DPC II Plus system's ultrasound signal delivery, perform the following steps.

1. For the initial test, the generator must be **ON LINE**. Refer to step 5 on the previous page.
2. Position the probe so that its horn is not in contact with anything. Do not hold the probe if you are not accustomed to ultrasonic welding. The initial ultrasonic sensation may surprise you and cause you to drop the probe. Momentarily press the generator control **TEST** key (G in Figure 11-2). The following conditions should occur.

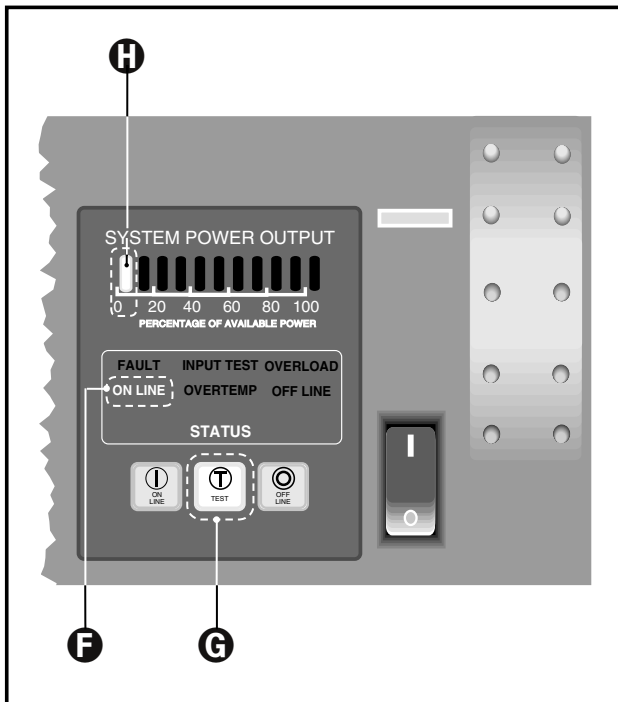

Figure 11-2 System Test Controls and Indicators

3. One green segment of the System Power Output bar display will light up indicating normal operation (H in Figure 11-2.)
4. The **ON LINE** status indicator goes blank. This indicates the ultrasonic probe is activated. The probe should operate without any unusual noise. The probe will operate as long as the **TEST** key is pressed.

5. When the **TEST** key is released, the **ON LINE** status indicator lights up again and the Power Output display goes blank.

NOTE

Neither a press system, automation system, hand probe or **TEST** key can trigger the generator to produce an ultrasound output if the DPC II Plus is **OFF LINE**.

The Front Panel Control Lock (Pin No. 15 on the HD-15 System Input connector) will disable the **TEST** key from producing an output. Refer to Section 5, Table 5—I.

The F P Control Lock will also inhibit any programming changes. The menu navigation will function normally, but data entry is inhibited.

System Operation

1. If the generator is not online, press the **ON LINE** key. This is labeled E in Figure 11–1. The green **ON LINE** status should light up (F in Figure 11–2).
2. Program the appropriate weld method and time or energy to achieve the desired welding results.
3. Apply the probe to the components to be ultrasonically joined, and press the probe's activation switch, or press the palm switches on the press base. In automation systems, the customer supplies external controls to trigger the generator.
4. The Power Output display will light up to indicate the percentage of power being delivered to the probe while the trigger switch is engaged.
5. The Power Output display should never reach 100% during normal operation.
6. The Power Output display should go blank indicating zero output power, after the probe trigger is released.

Stopping the Weld Cycle

Hand Probe System

Release the trigger switch on the hand probe to stop the welding cycle.

Automated System

The customer-supplied external controls provide the means to stop the welding cycle for an automated system.

Press System

Push in the Emergency Stop button on the press base to stop the welding cycle.

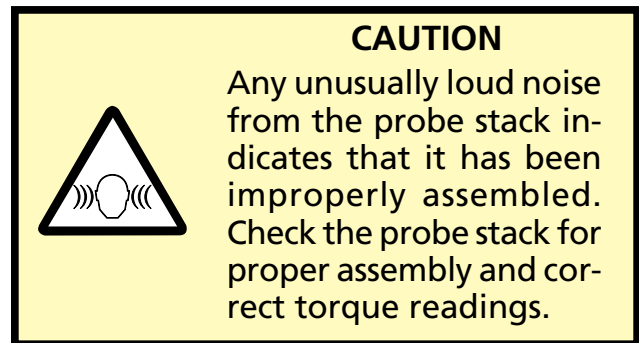

End of Day

Push the **OFF LINE** generator control key on the front panel (I in Figure 11–3).

The yellow **OFF LINE** status indicator (J in Figure 11–3) should be illuminated.

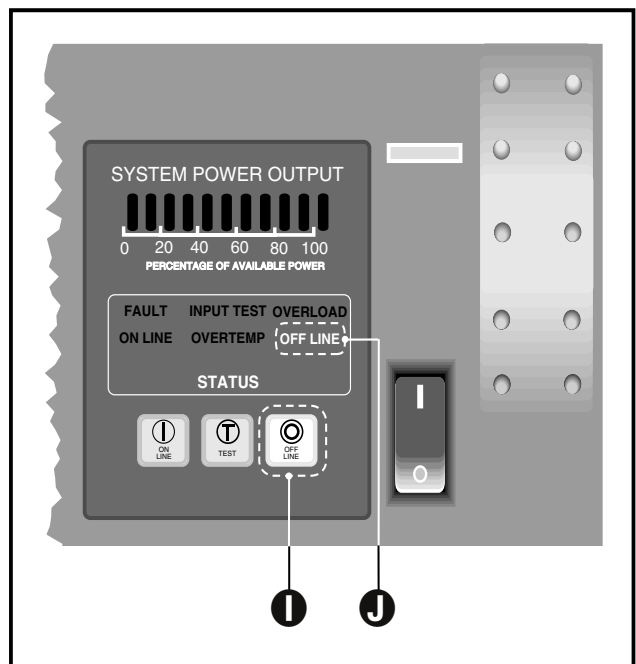

Figure 11–3 Stopping the Weld Cycle

This page intentionally left blank

Troubleshooting

- No Ultrasonic Output
- Generator Faults
- INPUT TEST Indicator
- TEST Control Key
- Troubleshooting Flowchart
- Error Messages

No Ultrasonic Output	125
Probe	125
Cable	125
Generator	126
Operate Input	126
Generator Faults	127
OVERLOAD Indicator	127
OVERTEMP Indicator	127
FAULT Indicator	127
Generator Errors	128
INPUT TEST Indicator	128
TEST Control Key	128
Troubleshooting Flowchart	129
Error Messages	131

This page intentionally left blank

No Ultrasonic Output

Probe

Make sure that the probe coaxial cable is connected to the generator Ultrasonic output connector J1 (see Figure 12–1). Make sure the probe stack was assembled following the instructions in Section 10.

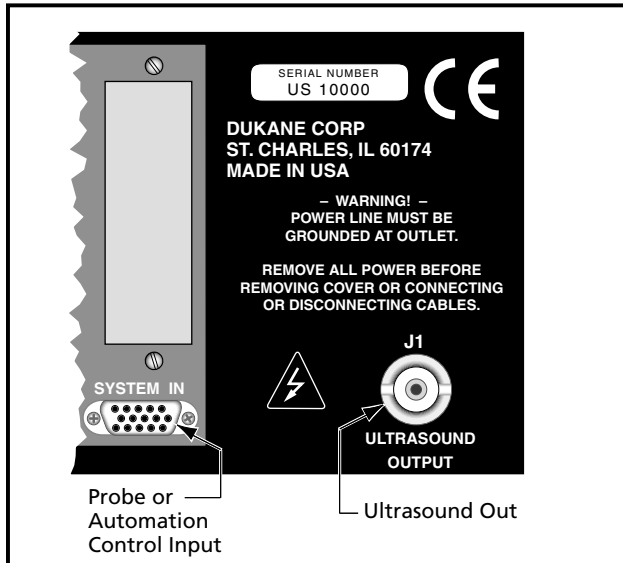

Figure 12–1 Rear Ultrasound and System-In Connectors

Cables

Make sure that both the U/S coaxial and Control Input cables are connected. You must have a trigger input to the SYSTEM IN HD-15 connector either by the probe's control cable or custom automation. Refer to Figures 3–4 through 3–8 for details. Put the generator OFF LINE and turn off the AC power switch. Check the coaxial cable for any signs of damage which may result in an open circuit preventing the cable from transmitting the signal from the generator to the probe. If you have a mounted probe, replace the coaxial cable with a known good cable. If you are using a hand probe, try a different known good probe to determine if the problem is related to the generator or external cables and probe.

CAUTION



Always turn the AC power off and wait a few seconds, before disconnecting or connecting any cable to the DPC. Failure to turn off the AC power may result in damage to the generator or probe.

Generator

The generator will not produce an output signal when triggered if it is OFF LINE. Make sure that the green power indicator [A] is lit. The status display should indicate ON LINE which is marked as [B] in Figure 12–2. If the generator is OFF LINE, press the ON LINE control key [C].

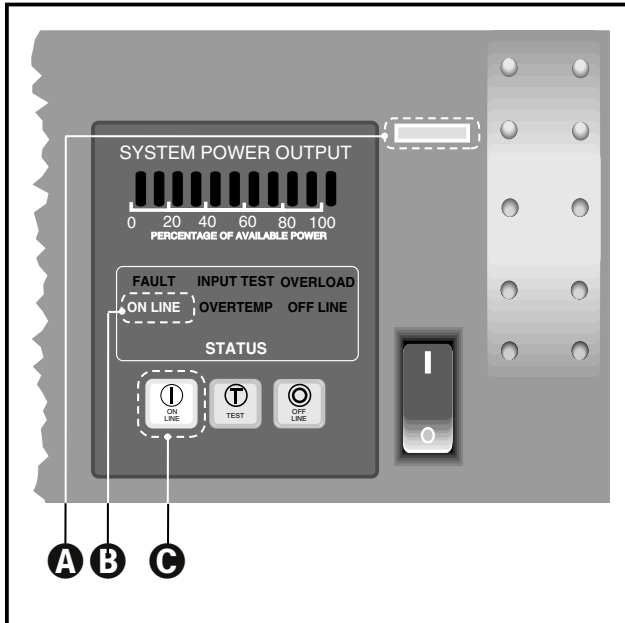

Figure 12–2 Generator ON LINE Key and Indicator

Operate Input

If you are using a hand probe, make sure the control cable is connected to the System Input connector. The trigger on the hand probe activates the Ultrasonic output through the control cable.

If you have supplied custom automation signals, pin 8, or pins 3 & 4 of the Operate Input must be used to trigger the Ultrasonic output. The system control inputs are user configurable. Refer to Section 5, Jumper Block SH707 for a detailed description of the options. The factory default setting (JU724) is a contact closure to ground. If you are using the isolated source jumper position (JU 726), then the input requires a minimum of 5V to trigger the generator.

NOTE

Figure 5–3 shows the male cable end of the System Input connector and is repeated here. The cable end connector is a mirror image of the female panel connector shown in Figure 5–2. Make sure you have correctly wired the connector if you are using custom automation signals.

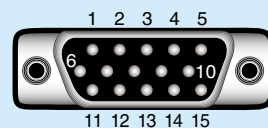

Generator FAULTs

OVERLOAD

If the generator OVERLOAD light comes on, it indicates excessive power is being drawn. This could be caused by a mismatch between the ultrasonic signal and the resonant characteristics of the acoustic stack. Improperly assembled probes may draw excessive power if their components were not properly torqued to specifications. Make sure you have the correct probe and horn. A 40kHz probe and a 20kHz DPC may result in an instantaneous overload. The same is true for the reverse combination. Excessive power drawn by the load may result in damage to the probe and horn.

OVERTEMP

If the OVERTEMP indicator comes on, it indicates that one of the generator's power modules has overheated. This may occur due to a cooling fan failure or excessive dust inside the cooling channel. The module's temperature sensor will automatically shut down the generator. The generator will automatically reset and turn off the OVERTEMP indicator when the module temperature drops below the 75°C (167°F) trip point.

FAULT

If the generator FAULT light comes on, it indicates an out-of-tolerance voltage condition. This could be related to one of two conditions.

1. AC line voltage out of tolerance. Refer to Table 15—I for the AC voltage specifications.
2. Internal DC power supply problems (+5VDC, +12VDC, -12VDC or +24VDC).

If the AC line voltage is within tolerance, then the DPC has an internal fault. Contact your local Dukane representative.

NOTE

The OVERLOAD, OVERTEMP and FAULT indicators are triggered by independent sensors. It is possible to get more than one error indicator. The ultrasonic output is disabled on any one of the errors.

Generator Errors

INPUT TEST Indicator

Steady Red

During power up, the INPUT TEST indicator should flash red for 5–10 seconds. This indicates the power-up test is running. When the test has successfully completed, the INPUT TEST indicator goes out. If the INPUT TEST indicator flashes and then remains in a steady red state, there are two possible causes.

1. The AC line level may be out of the specified operating range. Check the AC power to determine if it is within the limits specified in Section 15.
2. If the AC power is within specifications, the DPC has an internal circuit fault preventing normal operation. Contact your local Dukane representative.

Does Not Flash

If the INPUT TEST indicator does not flash during power up, check the AC line input. Both the rear panel and front panel AC breaker switches must be in the ON position, and the DPC line cord must be properly connected to a live AC outlet. The generator will not turn on if the line voltage is below the rated minimum. The INPUT TEST indicator should light up even without a probe connected.

TEST Control Key

The TEST key should cause the first green bar on the power display to light even without a probe (see System Test in Section 11 and Figure 11–2). If the TEST control key will not trigger the INPUT TEST light, check that pin 15 of the System Input is not grounded. A contact closure between this pin and ground (pin 2 or 7) will lock out the front panel TEST key.

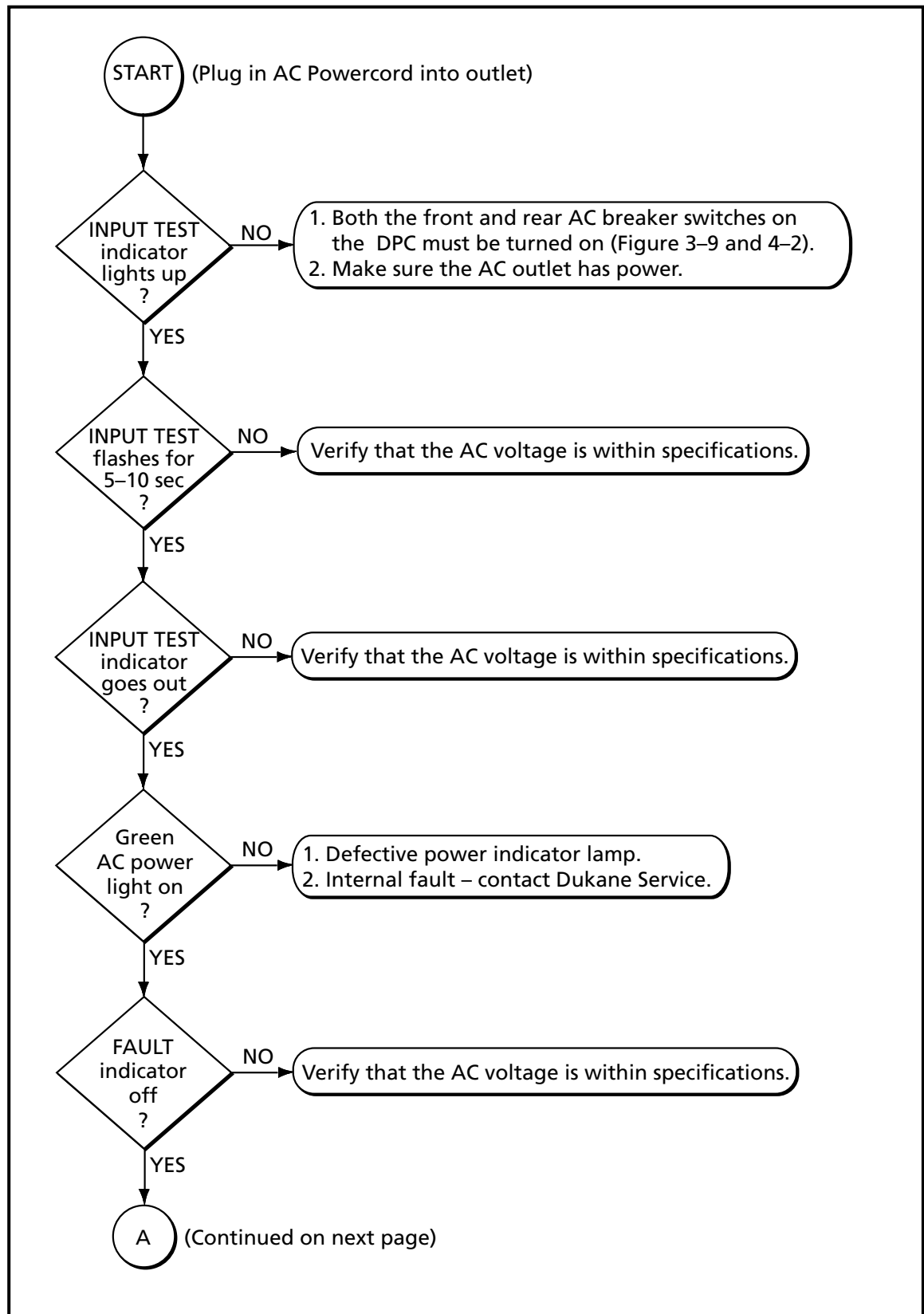

Figure 12-3 Troubleshooting Flowchart – Part 1

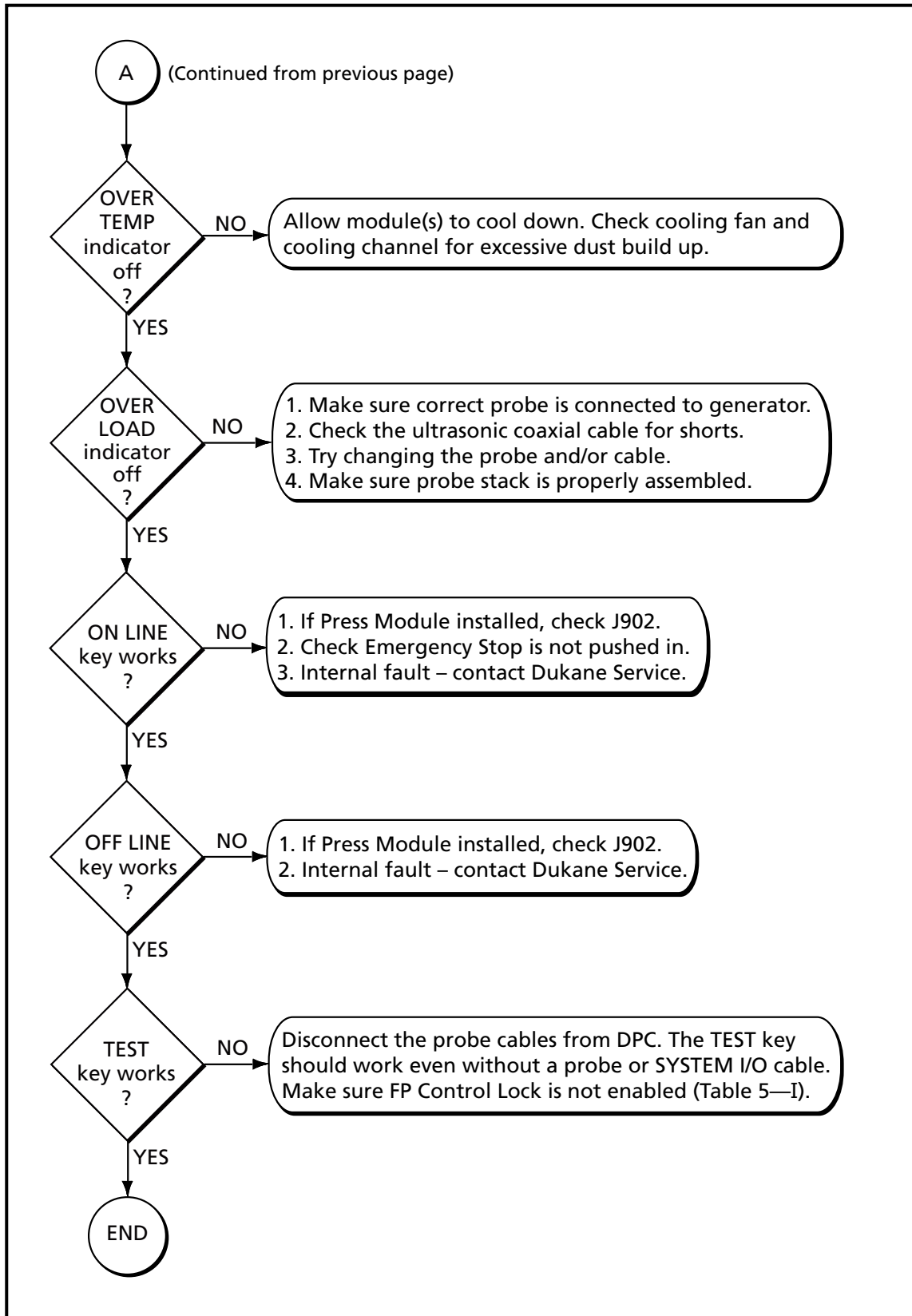

Figure 12-4 Troubleshooting Flowchart – Part 2

Error Messages

TRIGGER LOST

This error message is displayed when the trigger type is set to MAINTAINED, and the trigger signal is interrupted or lost. The weld cycle is terminated.

END OF WELD SIGNAL DETECTED

At the start of the cycle, one or both of the END OF WELD signals (AUTOMATION END OF WELD and PRESS END OF WELD) becomes active. The weld cycle is terminated.

TIMER STOP SIGNAL DETECTED

During the weld cycle, the TIMER STOP signal becomes active. The weld cycle is terminated.

SYSTEM OVERLOAD SIGNAL DETECTED

During the weld cycle, the SYSTEM OVERLOAD signal becomes active. The weld cycle is terminated.

AUTOMATION FAULT SIGNAL DETECTED

During the weld cycle, the AUTOMATION FAULT signal becomes active. The weld cycle is terminated.

RIGHT SAFETY SWITCH RELEASED TOO SOON

If the Initiate Mode is set to MANUAL, the right safety switch was released too soon at the start of the weld cycle. Both switches must be held until the trigger switch is activated. The weld cycle is terminated.

LEFT SAFETY SWITCH RELEASED TOO SOON

If the Initiate Mode is set to MANUAL, the left safety switch was released too soon at the start of the weld cycle. Both switches must be held until the trigger switch is activated. The weld cycle is terminated.

SYSTEM OFF LINE

The SYSTEM OFF LINE signal is active. The DPC generator must be ON LINE in order to produce an ultrasonic output signal.

FRONT PANEL LOCKED

KEYPAD ENTRY NOT ALLOWED

If the F P LOCK signal is active, the menu navigation functions normally, but data entry or program modifications are inhibited. For more information, refer to Section 5, Table 5—I and the Input Signal Description following the table.

This page intentionally left blank

Care & Maintenance

- Front Panel
- Rear Panel
- Chasis
- Probes
- Reconditioning

Front Panel	135
Rear Panel	135
Chasis	135
Stack Surfaces	136
Stack Maintenance	136
Stack Inspection	136
Even Contact	136
Uneven Contact	136
Crowning	137
Center Depression	137
Corrosion	137
Reconditioning	138
Overview	138
Machining the Mating Surfaces	138
Manual Resurfacing	138

This page intentionally left blank

Front Panel

Cleaning

Do not use any solvents or abrasive cleaners on the front panel. Do not spray cleaner directly onto the front panel. Apply a small amount of computer cleaner to a soft towel first. Clean the panel with the moistened towel. Do not spray or apply the cleaner directly to the DPC. Do not allow any liquid to collect around the AC power switch.

Display

Do not use a sharp object on the display.

Control Keys

Use your finger to press the control keys. Do not use sharp objects on the keys. If your hands are greasy or contaminated with dirt, use a soft object like a pencil eraser to push the keys.

Rear Panel

Connectors

The rear panel System Input and Status Output each have a pair of 4-40 threaded nuts to secure the connectors. Do not overtighten them

AC Power Cord

The AC power cord should be kept in good condition and free from any cuts. The AC plug should be straight with no bent prongs.

Grounding Stud

The rear chassis earth ground connection (see Figures 2–5 and 3–3) is a 10–24 x 1/2" threaded stud. Do not overtighten the nut.

Chassis

Side Ventilation Slots

Keep the two side ventilation slots free from obstructions. If excessive dust or dirt collects on the slots, wipe or vacuum them clean. Do not use compressed air to clean them as this may force the dirt inside the chassis. The right hand slot (when viewed from the front) is the air intake and the left hand side is the exhaust. Allow at least 2 inches (5 cm) on either side for air circulation as shown in Figure 13–1.

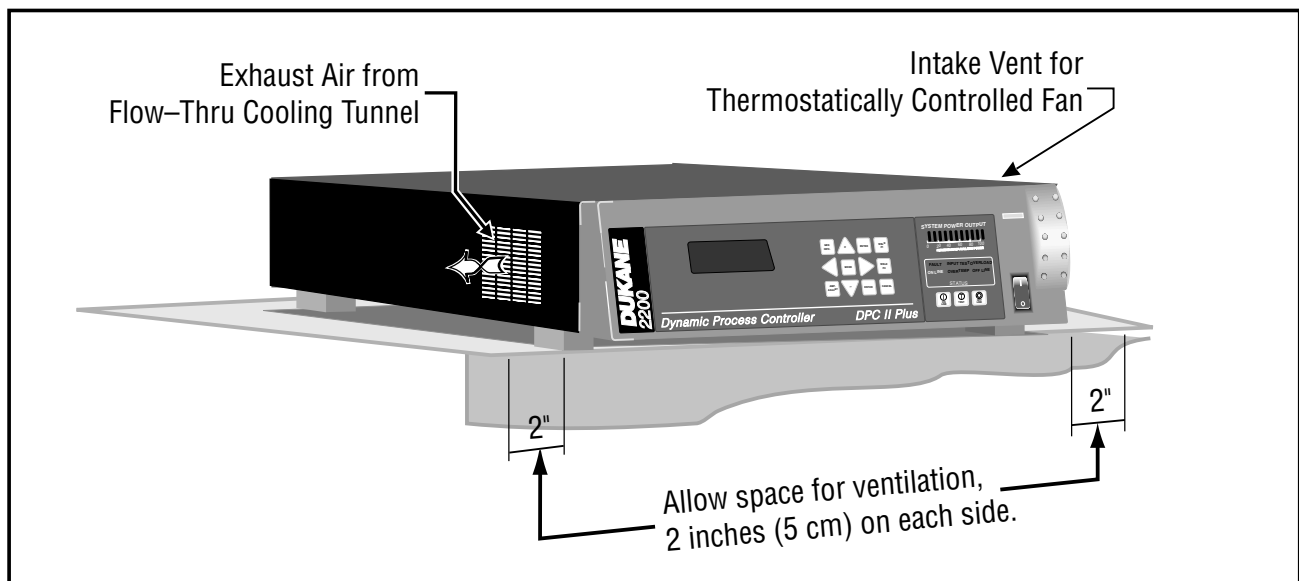

Figure 13–1 Location of DPC Air Cooling Vents

Top Cover

Keep the cover on at all times. The chassis is robust enough to hold considerable weight. However, avoid placing excessively heavy objects on top of the chassis which may bend or dent the top cover resulting in damage to internal components.

Replaceable Parts

The DPC is self contained and has no parts that are replaceable by the user. If a part needs replacement, contact your local Dukane representative. See Section 14 for contact information.

Stack Surfaces

Stack Maintenance

It is essential that the mating surfaces of the acoustic stack components be flat and smooth. When the components are joined together and tightened, there must not be any air gap between the surfaces.

If there is any air gap, there will be a loss in power and efficiency. Air has much higher transmission losses than the metal horn. Whenever the wavefront encounters an air gap, the propagation velocity is significantly reduced and attenuated. This results in considerable loss. In some cases, the union between the mating surfaces could be so poor as to prevent the probe stack from operating. This could result in excessive power drawn from the generator and may damage the mating surfaces. Figure 13–2 shows the mating surfaces on a typical probe and booster assembly.

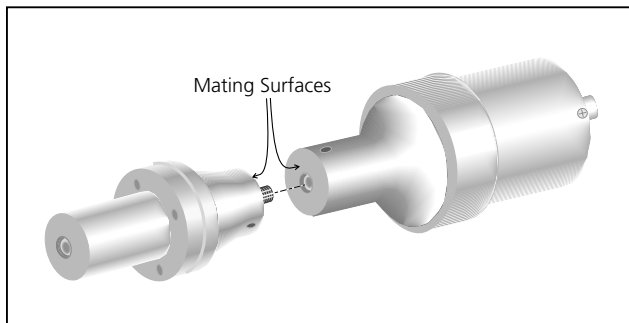

Figure 13–2 Location of Stack Mating Surfaces

Stack Inspection

Examine the mating surfaces of the horn and probe (and booster if applicable). Look for a shiny, burnished area. This indicates where the surfaces have been in contact. It will indicate whether the surfaces are flat and making good contact, or if they are uneven and making poor contact.

Inspection Schedule

To establish a maintenance schedule, inspect the mating surfaces after the first 200–400 hours of operation. If they require cleaning, halve the next inspection time. If the surfaces do not require re-conditioning, then double the next inspection time.

Surfaces with Even Contact

A flat surface will make even contact and its surface will be evenly burnished across the entire contact area.

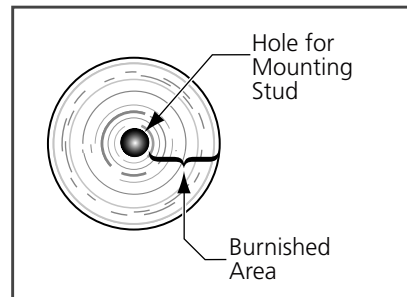

Figure 13–3 Flat Surface With Even Contact

Figure 13–3 shows a surface that has made even contact.

Surfaces with Uneven Contact

A surface that is not completely flat will make uneven contact. Its surface will be burnished only in the area where it has made contact. Figure 13–4 shows what such a surface would look like. The inner and outer areas have no marks on it indicating there has been no contact in these areas.

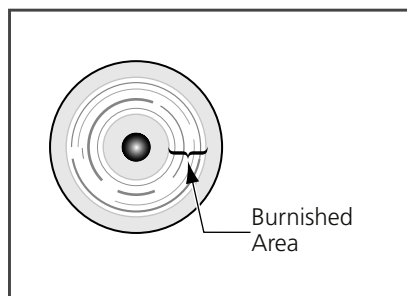

Figure 13–4 Flat Surface With Uneven Contact

indicating there has been no contact in these areas.

Crowning

A surface which is burnished only in the inner ring area around the stud, indicates the surface is convex or crowned. An example of this is shown in figure 13–5. To get an idea of amount of deviation from a flat surface, place a straight edge along the stack element. Since its surface is higher at the center than at the edges, there will be a gap at the outer edge of the element.

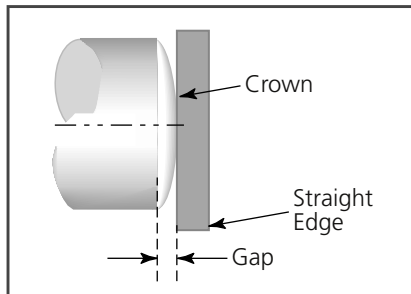

Figure 13–5 Crowned Surface

Center Depression

A surface which is burnished only in the outer ring area around the edge, indicates the surface is concave or depressed. An example of this is shown in figure 13–6. To get an idea of amount of deviation from a flat surface, place a straight edge along the stack element. Since its surface is higher at the edge than at the center, there will be a visible gap near the center indicating the depth of the depression.

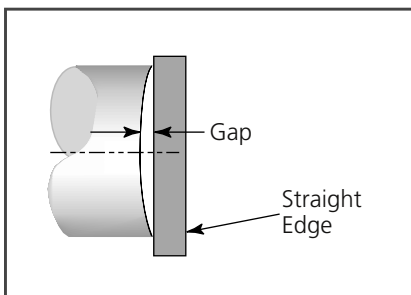

Figure 13–6 Center Depression

Corrosion

Corrosion is a factor to consider when determining the overall system performance. Over time, corrosion can build up on the mating surfaces of the acoustic stack. This build up interferes with the efficient transfer of ultrasonic energy to the parts to be welded. It may contribute to a loss in performance. Evidence of corrosion build up includes discolored mating surfaces or surfaces encrusted with hard deposits. To extend equipment life and maintain performance levels, minimize the system's exposure to corrosive sources.

Reconditioning

Overview

Stack components require reconditioning when the mating surfaces become uneven or corroded. These conditions cause poor contact between the mating surfaces which wastes power. It also makes tuning the stack difficult, can cause heat damage to the transducer, and can contribute to a higher system noise level.

Machining the Mating Surfaces

Instructions on how to properly machine the stack components is beyond the scope of this manual. Please call Dukane's Tooling Support Team for machining information. A list of Dukane contacts is provided in Section 14.

Manual Resurfacing

To manually resurface the stack component mating surfaces, follow the steps given here.

1. Disassemble the acoustic stack and wipe all the mating surfaces clean. Use a clean cloth or a paper towel.
2. Examine all the surfaces. If any are corroded, discolored or coated with hard deposits, they should be reconditioned.
3. If the surfaces appear to be in good condition, proceed to step 11.
4. Remove the mounting stud(s) if any are installed.
5. Tape a clean sheet of #400 grit (or finer) emery cloth grit side up to a clean, flat surface such as a piece of plate glass.
6. Hold the stack component with one hand near the bottom as shown in Figure 13–7. This view shows the thumb covering one of the three spanner wrench holes.

Without applying any downward pressure, carefully stroke the part **in one direction** across the emery cloth. The component's weight alone is enough pressure as the part is

NOTE

Before deciding to recondition the mating surfaces yourself, consider calling Dukane Corporation's Tooling Support team to discuss the situation. This is especially important if the mating surfaces are uneven, because machining of the component(s) may be required. Factory personnel can offer their skills and experience to help you determine the options for your particular needs.

See Section 14 for a list of Dukane contacts.



CAUTION

An improperly altered horn can cause destructive stress to the transducer, booster, generator and horn. The horn should only be modified by Dukane's Horn Department.

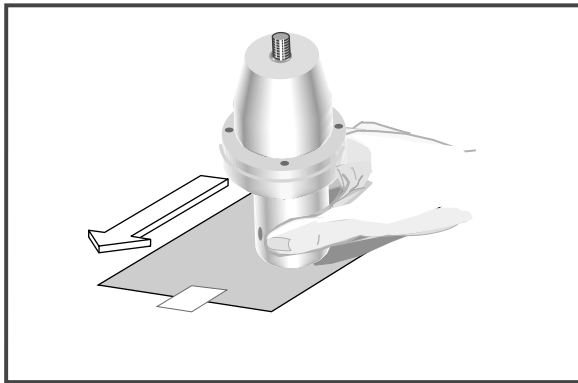

Figure 13-7 Manual Resurfacing

moved across the emery cloth. Complete a second stroke across the cloth just like the first.

7. Keep the element's surface flat against the emery cloth and turn it 120° (one-third of a complete rotation) so the thumb covers the next spanner wrench hole. Again move the part twice across the emery cloth as covered in the previous step.
8. Give the part a final one-third turn and repeat the two strokes described in Step 6.
9. Reexamine the mating surfaces. Repeat Steps 6 through 8 until the corrosion has been removed.
10. Clean any grit from the resurfaced element and the stud mounting threads using a clean cloth or paper towel.
11. If you had to remove the mounting studs, they need to be reinserted. Before they are reinserted, it is necessary to ensure proper thread engagement.
 - a. Inspect and clean the stud.
 - b. Clean the threaded hole with a clean cloth.
 - c. Thread the stud into the hole. Tighten the stud to the torque specifications given in Table 10—II.
12. Reassemble the stack and install it using the procedure in Section 10 using Figures 10-6 and 10-7 as guides.
13. Complete the Operational Test in Section 11.



CAUTION

Use extreme care to keep the part level when moving it across the emery cloth. Be careful not to tilt the part. An uneven mating surface could leave the mating surface inoperative.

Surface flatness is more important than surface finish.



CAUTION

It is important to perform only two strokes each time the component is rotated. Performing more than two strokes affects whether the surface remains flat. It is important for the mating surface to maintain its perpendicularity in relationship to the component's centering axis. If this relation between the surface and the axis is altered, the welding system may become inoperative.

NOTE

If the studs are overtightened, the threads may deform. Removing a stud that has been overtightened could damage the threads in the horn/booster. If this should happen, retap the horn/booster threads and replace the stud with a new one.

This page intentionally left blank

SECTION 14

Contacting Dukane

- Corporate Office
- Extensions & eMails



Ultrasonics Division Main Office	143
Email Addresses	144
Telephone Extensions	144

This page intentionally left blank

Contacting Dukane

Identify Equipment

When contacting Dukane about a service-related problem, be prepared to give the following information:

- DPC model number, line voltage and serial number
- Any fault indicators from the DPC status display
- Description of the problem and steps taken to resolve it

Many problems can be solved over the telephone, so it is best to call from a telephone located near the equipment.

Local Support

Your local Dukane representative has received factory training and can answer all of your questions regarding Dukane equipment.

Ultrasonics Division

Mailing Address: Dukane Ultrasonics
2900 Dukane Drive
St. Charles, IL 60174 USA

Main Phone: (630) 797-4900

Main Fax: (630) 797-4949

Service & Parts Fax: (630) 584-0796

Department Phone Numbers

You can reach each department by dialing directly

Application Support (630) 797-4930

For applications and/or process technology questions.

Engineering (630) 797-4950

For engineering of standard and customized systems.

Service & Parts (630) 762-4090

For equipment servicing or replacement parts.

Tooling (630) 797-4930

For information on tooling, fixtures and horns.

Department email Addresses

Applications: usapps@dukcorp.com

Engineering: useng@dukcorp.com

Service & Parts: usservice@dukcorp.com

Tooling: ustooling@dukcorp.com

Our Website

Dukane Ultrasonics is on the world wide web at:

<http://www.dukcorp.com/us>

and then go to your area of interest.



NOTE

See the next page for additional department phone numbers and email addresses.

Ultrasonics Division email Addresses

Applications: usapps@dukane.com
Engineering: useng@dukane.com
Food Processing: usfoodproc@dukane.com
International Sales: usintl@dukane.com
Marketing: usmktg@dukane.com
Sales: ussales@dukane.com
Support/Service & Parts: usservice@dukane.com
Technical Writing: ustechwriting@dukane.com
Tooling: ustooling@dukane.com
Training: ustraining@dukane.com

Ultrasonics Division Phone Numbers

Application Support (630) 797-4930

For applications and/or process technology questions.

Engineering (630) 797-4950

For engineering of standard and customized systems.

Food Processing (630) 797-4920 or -4938

For information about using ultrasonics in food processing.

International (630) 797-4915

For questions about international locations, support, etc.

Marketing (630) 797-4906

For product literature, and trade show information.

Metal Welding (630) 797-4953

For information about any aspect of metal welding.

Sales (630) 797-4918

Your local Dukane representative is the main source of product and order information, however you may have a need to contact Sales.

Service & Parts (630) 762-4090

For equipment servicing or replacement parts.

Technical Writing (630) 797-4907

For information and comments about user's manual content.

Tooling Support (630) 797-4930

For information about tooling, horns, and fixturing.

Training Hotline (630) 797-4904

We offer a curriculum of educational programs at our corporate headquarters in St. Charles, Illinois. Please call the Dukane Ultrasonics Training Hotline for a free Education Catalog or with any questions you may have.

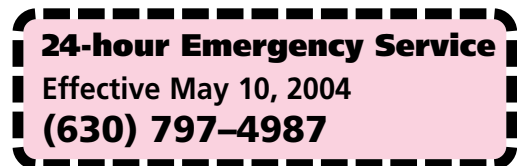

Specifications

- Regulatory Compliance
- Dimensions
- Power Requirements and Model Ratings

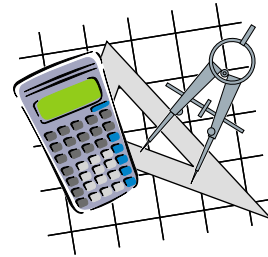

Regulatory Compliance	147
Federal Communications Commission	147
CE Marking (Conformité Européenne)	147
Dimensions	148
Operating Environment	148
Power Requirements	149
Interpreting The DPC Model Number	150

This page intentionally left blank

Regulatory Agency Compliance

FCC

The DPC II Plus complies with the following Federal Communications Commission regulations.

- The limits for FCC measurement procedure MP-5, “Methods of Measurement of Radio Noise Emissions from ISM Equipment”, pursuant to FCC Title 47 Part 18 for Ultrasonic Equipment.

CE Marking

This mark on your equipment certifies that it meets the requirements of the EU (European Union) concerning interference causing equipment regulations. CE stands for Conformité Européenne (European Conformity). The DPC II Plus complies with the following CE requirements.

- The EMC Directive 89/336/EEC for heavy industry —
EN55011 and
EN50082 using
EN61000-4-2
EN61000-4-3
EN61000-4-4
EN61000-4-5
EN61000-4-6
EN61000-4-8
ENV50204
- The Low Voltage Directive 73/23/EEC.
- The Machine Directive 89/392/EEC using EN60204-1:1993 Safety of Machinery – Electrical Equipment of Machines. Part 1: Specification for General Requirements.

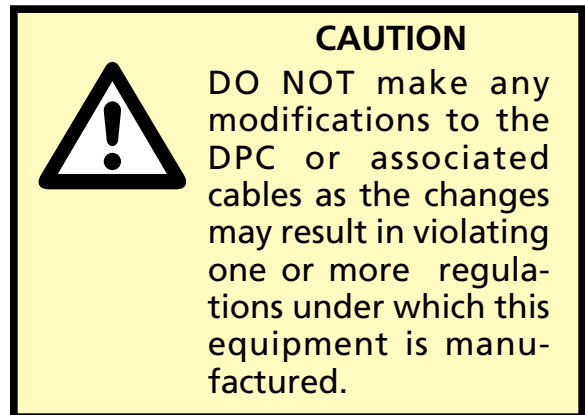

Dimensions

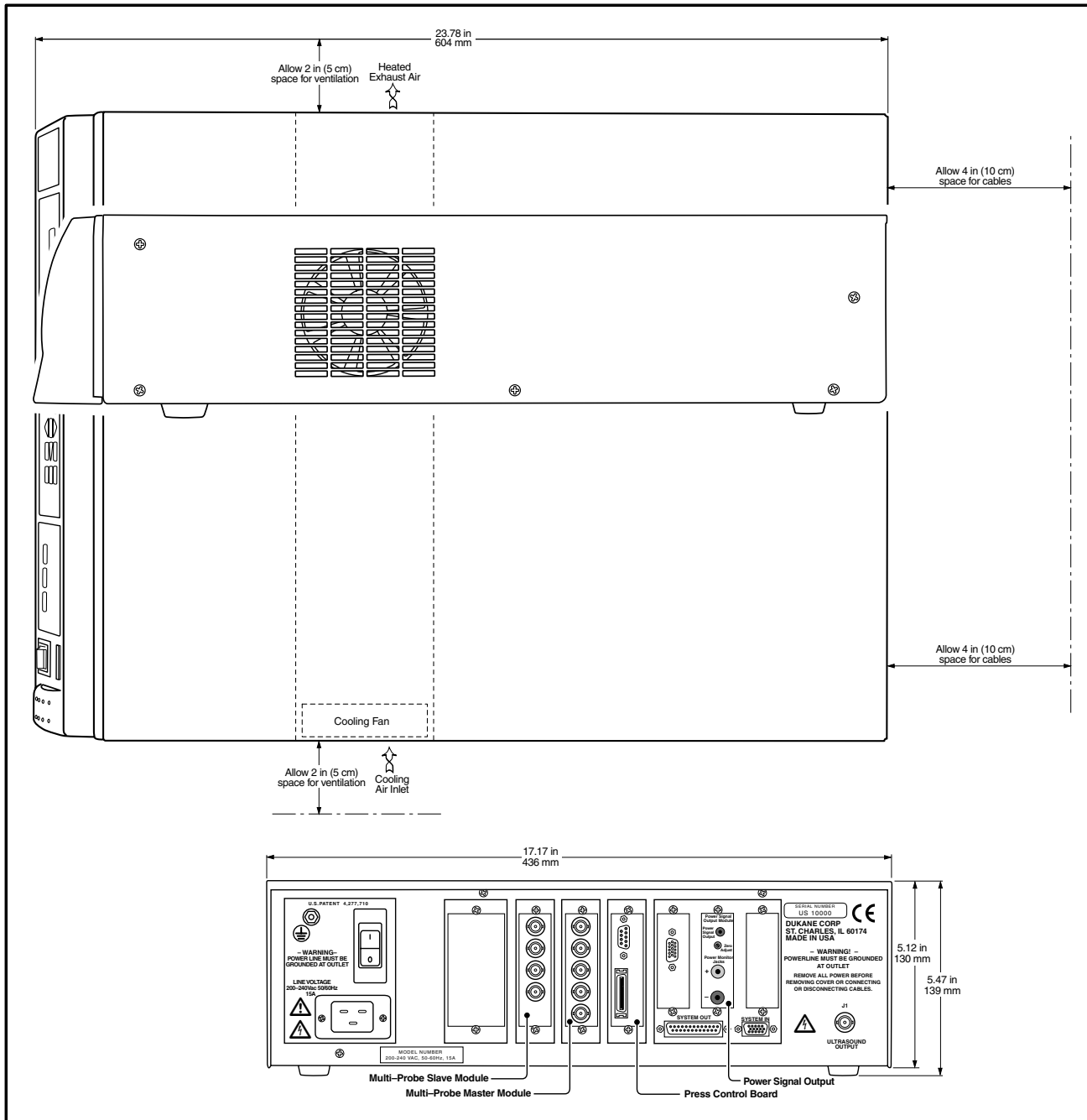

Figure 15-1 Generator 3-View and Dimensions

Operating Environment

Operate the DPC II Plus within these guidelines:

- Temperature:** 40°F to 100°F (+5°C to +38°C)
- Pressure:** Ambient
- Air Particulates:** Keep the DPC dry.
Minimize exposure to moisture, dust, dirt, smoke and mold.
- Humidity:** 5% to 95% Non-condensing @ 0°C to +30°C
- Vibration:** 1.0 G

Storage guidelines:

- Temperature:** -4°F to 158°F (-20°C to +70°C)
- Humidity:** 5% to 95% Non-condensing @ 0°C to +30°C
- Vibration:** 2.5 G

Power Supply Requirements

The AC power requirements depend on the frequency and power rating of the generator. The tables below, list the nominal AC requirements (maximum current drawn before overload) and the service rating of the AC outlet each model of the DPC II Plus and DPC EZ is designed for.

Frequency	DPC-2 Plus Generator Model	Peak Power Rating (Watts)	Nominal Input Power Requirements	AC Outlet Current Rating
20 kHz	2050	500	95–130V 50/60 Hz @ 8 Amps	15 Amps
			190–260V 50/60 Hz @ 4 Amps	15 Amps
	2120	1200	95–130V 50/60 Hz @ 15 Amps	15 Amps
			190–260V 50/60 Hz @ 8 Amps	15 Amps
	2170	1700	190–260V 50/60 Hz @ 12 Amps	15 Amps
2220	2200	190–260V 50/60 Hz @ 15 Amps	15 Amps	
30 kHz	3150	1500	190–260V 50/60 Hz @ 12 Amps	15 Amps
40 kHz	4035	350	95–130V 50/60 Hz @ 6 Amps	15 Amps
			190–260V 50/60 Hz @ 4 Amps	15 Amps
	4070	700	95–130V 50/60 Hz @ 12 Amps	15 Amps
			190–260V 50/60 Hz @ 8 Amps	15 Amps
	4100	1000	95–130V 50/60 Hz @ 15 Amps	15 Amps
190–260V 50/60 Hz @ 8 Amps			15 Amps	
50 kHz	5015	150	95–130V 50/60 Hz @ 6 Amps	15 Amps
			190–260V 50/60 Hz @ 4 Amps	15 Amps
70 kHz	7010	100	95–130V 50/60 Hz @ 6 Amps	15 Amps
			190–260V 50/60 Hz @ 4 Amps	15 Amps

Table 15—I DPC II Plus Generator Model and Power Supply Requirements

Frequency	DPC EZ Generator Model	Peak Power Rating (Watts)	Nominal Input Power Requirements	AC Outlet Current Rating
20 kHz	1000EZ	1000	95–130V 50/60 Hz @ 15 Amps	15 Amps
			190–260V 50/60 Hz @ 8 Amps	15 Amps
	1000EZX	1000	95–130V 50/60 Hz @ 15 Amps	15 Amps
			190–260V 50/60 Hz @ 8 Amps	15 Amps
	2000EZ	2000	190–260V 50/60 Hz @ 15 Amps	15 Amps
2000EZX	2000	190–260V 50/60 Hz @ 15 Amps	15 Amps	

Table 15—II DPC EZ Generator Model and Power Supply Requirements

Interpreting the DPC II Plus Model Number

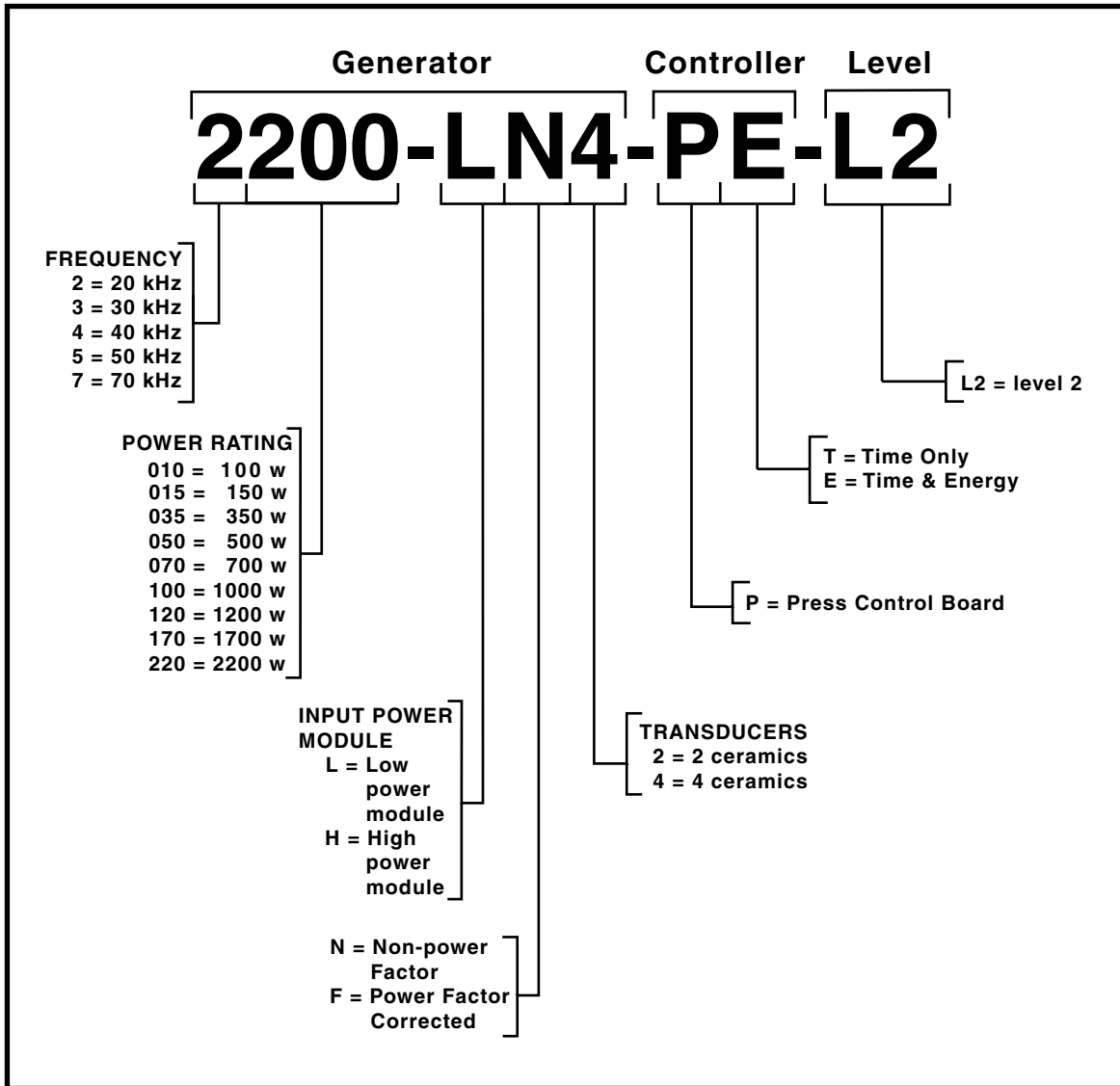

Figure 15-2 Interpreting the DPC II Plus Model Number

NOTE
 Figure 15-2 is designed to help you determine which options your DPC II Plus has. It is not meant to suggest that all combinations of these options are possible.

Warranty

- Domestic Warranty
- International Warranty

Domestic warranty	153
International Warranty	154

This page intentionally left blank

DUKANE CORPORATION**NORTH AMERICAN WARRANTY POLICY**

Subject to the terms, limitations and exclusions set forth below, Dukane Corporation IAS Division (Dukane) warrants to the original Purchaser, unless otherwise expressly agreed to in writing by Dukane, that all equipment and tooling designed and built by Dukane will be free from defects in material or workmanship. Normal wear items are not covered by this warranty. Warranty duration shall be defined as documented herein and in conjunction with any exceptions or exclusions in the accompanying Dukane quotation to the Purchaser.

Equipment Type	Equipment Warranty Duration	Other Comments
Custom Systems	12 months on all Dukane designed and built content that is not part of our standard product.	Dukane standard product included in custom systems are covered by the applicable product warranty.
Hot Plate Welder	24 months	none
Laser Welder	For all laser sources, Original equipment manufacturer (OEM) warranty is applicable.	All internal laser optics and external beam delivery optics are warranted for only 30 days.
Spin Welder	24 months	none
Thermal Press	24 months	none
Ultrasonic Welder	36 months	See WARRANTY EXCLUSIONS OR EXCEPTIONS below.
Vibration Welder	24 months	none
All Production Tooling	12 months, one-time replacement. (6-month, one-time replacement for carbide tipped horns)	none
Prototype Tooling	<ul style="list-style-type: none"> • All tooling made from Renshape 460 (Renwood) are only warranted for 200 part-cycles. • All other prototype tooling is warranted as described in each specific proposal. 	Prototype Renshape 460 (Renwood) tools employ reusable content, and therefore remain the property of Dukane.

All Dukane warranties commence on the date of the original shipment of the equipment or tooling, and duration is based upon a single shift per day, five day per week operation. The warranty period on rentals of new equipment that are converted to a purchase are deemed to have commenced on the initial date of rental.

These warranties are limited to equipment and tooling operated and maintained per Dukane's written instructions, and used under normal operating conditions. These warranties do not include normal wear or normal wear items, and do not cover damage attributable to misuse, improper installation, faulty repair, unauthorized alteration or modification, neglect, or accident. Misuse includes operation of equipment with tooling that is not qualified for the equipment or properly installed on the equipment.

The warranty on all Dukane equipment and tooling purchased and installed in North America is a parts and labor warranty only. Equipment installed outside of North America, regardless of where it was purchased, is covered by Dukane's International Warranty Policy. In all cases, when on-site service is required, Travel & Living (T&L) expenses will be billed at cost. Warranty service labor (including travel time) at the customer's site is provided on a Monday through Friday (excluding holidays), 7 a.m. to 7 p.m. basis. Any warranty service requested outside of these hours is available on a charge basis equal to 150% of Dukane's prevailing rate for technical service work.

Any equipment or tooling that proves to be defective in material or workmanship during the stated warranty period will be repaired or replaced at the sole discretion of Dukane Corporation when Dukane is promptly notified in writing. During the warranty period, defective equipment, components, or tooling that are returned properly packed with all transportation charges prepaid will be repaired or replaced and returned to the end-user without charge. Shipments of warranty parts will be via standard, non-expedited delivery service. Expedited shipment requests are subject to freight charges to the Purchaser.

Computers, PLCs, CRTs, LCDs, touch screens, and keyboards separate and/or incorporated as an integral part of a system will carry a one (1) year warranty from the date of shipment when used under normal operating conditions, and not subjected to misuse, abuse, or neglect. For all other equipment, components, or parts included in equipment or systems from Dukane, but not manufactured by Dukane or its affiliates, this warranty shall be limited in time and extent to the warranty given to Dukane by the OEM.

EQUIPMENT WARRANTY EXCLUSIONS OR EXCEPTIONS:

When specified in our quotation, a limited warranty may apply to certain components of the equipment, and/or for certain types of applications of the equipment, including those noted below.

- This warranty is void if the ultrasonic welder and/or tooling [i.e., horn(s) and fixture(s)] are used for applications requiring metal-to-metal contact, when the ultrasonic exposure period (weld cycle) exceeds 250 milliseconds.
- Ultrasonic Equipment and tooling used in continuous duty cycle modes such as, but not limited to, continuous cut and seal, and food processing are warranted for 2000 hours or 12 months from shipment, whichever occurs first.
- Any ultrasonic horn or tool quoted and sold as "Experimental" is not warranted.
- This warranty does not cover failures of equipment and components attributable to improper cooling or overheating of the transducer.
- Ultrasonic Horn Analyzers have a 12-month warranty.
- Ultrasonic Transducers have a one-time replacement warranty.
- Normal wear items and consumables excluded from any warranty coverage include, but are not limited to, filters, fuses, light bulbs, lubricants, gaskets and seals, cast urethane fixture components, laser flashlamps, laser beam delivery optics, and lasing gases.

The forgoing warranty is the sole and exclusive warranty and is made in lieu of all other warranties, express, implied or statutory, including without limitation any warranties of merchantability, fitness for a particular purpose, description, quality, productiveness or any other warranty. The remedy set forth in this warranty policy is the sole and exclusive remedy of Purchaser and in no event shall Dukane be liable for any compensatory, consequential, special, punitive or contingent damages or for damages arising from any delay in performance by Dukane under this warranty.

DUKANE CORPORATION

INTERNATIONAL WARRANTY POLICY

Subject to the terms, limitations and exclusions set forth below, Dukane Corporation IAS Division (Dukane) warrants to the original Purchaser, unless otherwise expressly agreed to in writing by Dukane, that all equipment and tooling designed and built by Dukane will be free from defects in material or workmanship. Normal wear items are not covered by this warranty. Warranty duration shall be defined as documented herein and in conjunction with any exceptions or exclusions in the accompanying Dukane quotation to the Purchaser.

Equipment Type	Equipment Warranty Duration	Other Comments
Custom Systems	12 months on all Dukane designed and built content that is not part of our standard product.	Dukane standard product included in custom systems are covered by the applicable product warranty.
Hot Plate Welder	12 months	none
Laser Welder	For all laser sources, Original equipment manufacturer (OEM) warranty is applicable.	All internal laser optics and external beam delivery optics are warranted for only 30 days.
Spin Welder	12 months	none
Thermal Press	12 months	none
Ultrasonic Welder	12 months	See WARRANTY EXCLUSIONS OR EXCEPTIONS below.
Vibration Welder	12 months	none
All Production Tooling	12 months, one-time replacement. (6-month, one-time replacement for carbide tipped horns)	none
Prototype Tooling	<ul style="list-style-type: none"> • All tooling made from Renshape 460 (Renwood) are only warranted for 200 part-cycles. • All other prototype tooling is warranted as described in each specific proposal. 	Prototype Renshape 460 (Renwood) tools employ reusable content, and therefore remain the property of Dukane.

All Dukane warranties commence on the date of the original shipment of the equipment or tooling, and duration is based upon a single shift per day, five day per week operation. The warranty period on rentals of new equipment that are converted to a purchase are deemed to have commenced on the initial date of rental.

These warranties are limited to equipment and tooling operated and maintained per Dukane’s written instructions, and used under normal operating conditions. These warranties do not include normal wear or normal wear items, and do not cover damage attributable to misuse, improper installation, faulty repair, unauthorized alteration or modification, neglect, or accident. Misuse includes operation of equipment with tooling that is not qualified for the equipment or properly installed on the equipment.

The warranty on all Dukane equipment and tooling purchased and installed in North America is a parts and labor warranty only. Equipment installed outside of North America, regardless of where it was purchased, is covered by Dukane’s International Warranty Policy. In all cases, when on-site service is required, Travel & Living (T&L) expenses will be billed at cost. Warranty service labor (including travel time) at the customer’s site is provided on a Monday through Friday (excluding holidays), 7 a.m. to 7 p.m. basis. Any warranty service requested outside of these hours is available on a charge basis equal to 150% of Dukane’s prevailing rate for technical service work.

Any equipment or tooling that proves to be defective in material or workmanship during the stated warranty period will be repaired or replaced at the sole discretion of Dukane Corporation when Dukane is promptly notified in writing. During the warranty period, defective equipment, components, or tooling that are returned properly packed with all transportation charges prepaid will be repaired or replaced and returned to the end-user without charge. Shipments of warranty parts will be via standard, non-expedited delivery service. Expedited shipment requests are subject to freight charges to the Purchaser.

Computers, PLCs, CRTs, LCDs, touch screens, and keyboards separate and/or incorporated as an integral part of a system will carry a one (1) year warranty from the date of shipment when used under normal operating conditions, and not subjected to misuse, abuse, or neglect. For all other equipment, components, or parts included in equipment or systems from Dukane, but not manufactured by Dukane or its affiliates, this warranty shall be limited in time and extent to the warranty given to Dukane by the OEM.

EQUIPMENT WARRANTY EXCLUSIONS OR EXCEPTIONS:

When specified in our quotation, a limited warranty may apply to certain components of the equipment, and/or for certain types of applications of the equipment, including those noted below.

- This warranty is void if the ultrasonic welder and/or tooling [i.e., horn(s) and fixture(s)] are used for applications requiring metal-to-metal contact, when the ultrasonic exposure period (weld cycle) exceeds 250 milliseconds.
- Ultrasonic Equipment and tooling used in continuous duty cycle modes such as, but not limited to, continuous cut and seal, and food processing are warranted for 2000 hours or 12 months from shipment, whichever occurs first.
- Any ultrasonic horn or tool quoted and sold as “Experimental” is not warranted.
- This warranty does not cover failures of equipment and components attributable to improper cooling or overheating of the transducer.
- Ultrasonic Horn Analyzers have a 12-month warranty.
- Ultrasonic Transducers have a one-time replacement warranty.
- Normal wear items and consumables excluded from any warranty coverage include, but are not limited to, filters, fuses, light bulbs, lubricants, gaskets and seals, cast urethane fixture components, laser flashlamps, laser beam delivery optics, and lasing gases.

The forgoing warranty is the sole and exclusive warranty and is made in lieu of all other warranties, express, implied or statutory, including without limitation any warranties of merchantability, fitness for a particular purpose, description, quality, productiveness or any other warranty. The remedy set forth in this warranty policy is the sole and exclusive remedy of Purchaser and in no event shall Dukane be liable for any compensatory, consequential, special, punitive or contingent damages or for damages arising from any delay in performance by Dukane under this warranty.

List of Figures

Figure 2-1	120Volt, Grounded, 3-Prong Receptacle	12
Figure 2-2	220Volt, Grounded, 3-Prong Receptacle	12
Figure 2-3	International 220/240V Grounding	13
Figure 2-4	DPC Grounding Arrangement	13
Figure 2-5	Press Grounding Arrangement	13
Figure 3-1	Installing a Benchtop DPC	17
Figure 3-2	Rack-mounted DPC Using Bracket Kit	18
Figure 3-3	DPC II Plus and EZ Rear Panel & Optional Modules	19
Figure 3-4	DPC II Plus and EZ Hand Probe Cabling Connections	21
Figure 3-5	DPC II Plus and EZ Automated Probe Cabling Connections	21
Figure 3-6	DPC II Plus Multiple Probe Cabling Connections	22
Figure 3-7	DPC II Plus Automated Thruster Cabling Connections	23
Figure 3-8	DPC II Plus and EZ Press Cabling Connections	24
Figure 3-9	Emergency Stop Switch Interface	25
Figure 3-10	Rear Panel AC Breaker Switch	25
Figure 4-1A	DPC II Plus Control Panel Layout	29
Figure 4-1B	DPC EZ Control Panel Layout	29
Figure 4-2	Front Panel AC Power Section	30
Figure 4-3	Generator Control Keys	30
Figure 4-4	System Status Display	31
Figure 4-5	Power Output Display Normal Operation	32
Figure 4-6	Power Output Display Warning Indicators	32
Figure 4-7	Menu Keys	33
Figure 4-8A	DPC II Plus GEN. INFO Menu Display	33
Figure 4-8B	DPC EZ GEN. INFO Menu Display	33
Figure 4-9	Menu Display – Typical Selection Menu	35
Figure 4-10	Menu Display – Typical Confirmation Screen	35
Figure 4-11	Menu Display – Typical Data Entry Screen	35
Figure 5-1	DPC II Plus and EZ Welder Rear Panel Connectors	39
Figure 5-2	HD-15 System Input Connector	40
Figure 5-3	Cable End of System Input Connector	40
Figure 5-4	DB-25 System Output Connector	42
Figure 5-5	Remote Amplitude Control Module	46
Figure 5-6	Current Loop Transfer Function Graph	46
Figure 5-7	Power Signal Output Module	47
Figure 5-8	Press Control Module	48
Figure 5-9	Press Connector Pin Identification	48
Figure 5-10	Master and Slave Multi-Probe Controller Modules	50
Figure 5-11	Card Slot, Connector & Jumper Block Locations	52
Figure 5-12	Jumper Block Details	53

Figure 6–1 DPC II Plus Startup Menu 57
 Figure 6–2 DPC II Plus Configuration Menu 57
 Figure 6–3 DPC II Plus Weld Cycle Display 57
 Figure 6–4 DPC II Plus Process Setup Menu 57
 Figure 6–5 Process Setup Main Menu Structure 58
 Figure 6–6 Process Control Menu Flowchart 59
 Figure 6–7 Limit Definition Menu Flowchart 60
 Figure 6–8 Utilities Menu Flowchart 61

Figure 7–1 DPC II Plus Startup Menu 65
 Figure 7–2 DPC II Plus Configuration Menu 65
 Figure 7–3 DPC II Plus Time Weld Cycle Display 65
 Figure 7–4 DPC II Plus Energy Weld Cycle Display 65
 Figure 7–5 Process Setup Menu 66
 Figure 7–6 Process Control Trigger Method Menu 66
 Figure 7–7 Hand Probe Flow Chart 66
 Figure 7–8 Hand Probe Weld Method Menu 67
 Figure 7–9 Hand Probe Weld Time Menu 67
 Figure 7–10 Hand Probe Weld Energy Menu 67
 Figure 7–11 Hand Probe Maximum Weld Time Menu 67
 Figure 7–12 Multi–Probe Controller Flowchart 68
 Figure 7–13 Auto Stop Weld Menu 68
 Figure 7–14 Probe Time Delay Menu 69
 Figure 7–15 Weld Method Selection Menu 69
 Figure 7–16 MPC Probe Weld Time Menu 69
 Figure 7–17 MPC Probe Weld Energy Menu 70
 Figure 7–18 MPC Probe Maximum Weld Time 70
 Figure 7–19 Ground Detect Fixture Isolation 70
 Figure 7–20 Ground Detect Scrub Time Data Entry 71
 Figure 7–21 Auto Probe Setup Flowchart 72
 Figure 7–22 Process Control Weld Method Selection 73
 Figure 7–23 Process Control Hold Time Selection 73
 Figure 7–24 Auto Probe Hold Time Data Entry Screen 73
 Figure 7–25 Auto Probe Afterburst Selection Menu 73
 Figure 7–26 Auto Probe Afterburst Enable Menu 73
 Figure 7–27 Auto Probe Afterburst Delay Data Entry 74
 Figure 7–28 Auto Probe Afterburst Duration Data Entry 74
 Figure 7–29 Process Setup Menu 74
 Figure 7–30 Press/Auto Probe Setup Flowchart 75
 Figure 7–31 Startup Welding Cycle Data Screen 77
 Figure 7–32 Mode and Enter Menu Keys 77
 Figure 7–33 Process Setup Menu 77
 Figure 7–34 Press Trigger Method Menu 77
 Figure 7–35 Press Initiate Mode Menu 78
 Figure 7–36 Press Trigger Type Menu 78
 Figure 7–37 First Pass Through Process Control Menu 78
 Figure 7–38 Single or Dual Pressure Selection Menu 78
 Figure 7–39 Pressure One Weld Method Selection Menu 78
 Figure 7–40 Pressure One Weld Time Data Entry 78
 Figure 7–41 Pressure Two Weld Method Selection Menu 79

Figure 7–42	Pressure Two Weld Energy Data Entry	80
Figure 7–43	Pressure Two Max Weld Time Data Entry	79
Figure 7–44	Dual Pressure Time Only Menu	79
Figure 7–45	Second Pass Through Process Control Menu	79
Figure 7–46	Press Hold Time Data Entry	80
Figure 7–47	Third Pass Through Process Control Menu	80
Figure 7–48	Press Afterburst Enable Menu	80
Figure 7–49	Press Afterburst Delay Data Entry	80
Figure 7–50	Press Afterburst Duration Data Entry	80
Figure 7–51	Return to Process Control Menu	80
Figure 7–52	Process Setup Menu	81
Figure 7–53	Dual Pressure Welding Cycle Data	81
Figure 7–54	Hot Keys	81
Figure 7–55	Min and Max Values for Hold Time	81
Figure 7–56	Modified Hold Time	81
Figure 7–57	Amplitude Adjust	82
Figure 7–58	Process Control Menu Flowchart	83
Figure 8–1	Process Setup Main Menu	90
Figure 8–2	Limit Definition Menu	90
Figure 8–3	Single Pressure Process Limits Menu	90
Figure 8–4	Limit Definition Flowchart	91
Figure 8–5	Dual Pressure Process Limits Menu	91
Figure 8–6	Single Pressure Max Energy Data Entry	92
Figure 8–7	Minimum Value Error Message	92
Figure 8–8	Dual Pressure Limits Selection Menu	92
Figure 8–9	P1 Maximum Energy Data Entry	92
Figure 8–10	CANCEL Key Return Path Flow Chart	92
Figure 9–1	Utilities Menu Flowchart	97
Figure 9–2	Process Setup Main Menu	98
Figure 9–3	Setup Utilities Menu	98
Figure 9–4	Setup Utilities Selection Menu	98
Figure 9–5	Setup Types Selection Menu	98
Figure 9–6	Enter New Setup Menu	98
Figure 9–7	New Setup Configuration Message	98
Figure 9–8	Source File Location Entry	99
Figure 9–9	Destination File Location Entry	99
Figure 9–10	Confirm Copy Files	99
Figure 9–11	Erase Setups Selection Menu	99
Figure 9–12	Confirm Erase Selected Setup	99
Figure 9–13	Erase Setup in Progress	99
Figure 9–14	Confirm Erase All Setups	100
Figure 9–15	Erasing All Setups In Process	100
Figure 9–16	Part Count Selection Menu	100
Figure 9–17	Confirm Reset Part Count	100
Figure 9–18	Confirm Counter Enabled	100
Figure 9–19	Counter Preset Value	101
Figure 9–20	Status Output Mode Selection	101
Figure 9–21	Cycle Press Selection Menu	101

Figure 10–1	Hand Probe, Horn and Replaceable Tip	105
Figure 10–2	Probe with Booster and Horn	106
Figure 10–3	Replaceable Tip Installation	107
Figure 10–4	Stack Assembly Procedure	109
Figure 10–5	Torque Value Conversion Graph	110
Figure 10–6	Hand Probe Assembly and Disassembly	111
Figure 10–7	Probe Stack With Booster Assembly and Disassembly	112
Figure 10–8	Separating The Horn From The Booster	113
Figure 10–9	Removing Replaceable Tip From Horn	114
Figure 11–1	Front Panel Startup Controls and Indicators	119
Figure 11–2	System Test Controls and Indicators	120
Figure 11–3	Stopping The Weld Cycle	121
Figure 12–1	Rear Ultrasound and System In Connectors	125
Figure 12–2	Generator ON LINE Key and Indicator	126
Figure 12–3	Troubleshooting Flowchart – Part 1	127
Figure 12–4	Troubleshooting Flowchart – Part 2	128
Figure 13–1	Location of DPC Air Cooling Vents	135
Figure 13–2	Location of Stack Mating Surfaces	136
Figure 13–3	Flat Surface With Even Contact	136
Figure 13–4	Surface With Uneven Contact	136
Figure 13–5	Crowned Surface	135
Figure 13–6	Center Depression	135
Figure 13–7	Manual Resurfacing	139
Figure 15–1	Generator 3–View and Dimensions	148
Figure 15–2	Interpreting the DPC II Plus Model Number	150
Figure C–1	Manual Control Switch	163
Figure C–2	Automation Control Switches	164
Figure C–3	Non–Isolated Current Sink Switch	165
Figure C–4	Non–Isolated Current Source Switch	166
Figure C–5	Isolated Current Source Circuit	167

List of Tables

Table 3—I	Contents of DPC II Plus Shipping Container	17
Table 3—II	DPC II Plus AC Power Cord Part Numbers	21
Table 5—I	System Input Connector Signals	40
Table 5—II	Remote Setup File Selection	40
Table 5—III	System Input Cable Color Code	41
Table 5—IV	System Output Connector Signals	42
Table 5—V	J902 Press Base Connector Pinout	48
Table 5—VI	J901 Thruster Connector Pinout	49
Table 7—I	Process Control Menu Listing	84
Table 7—II	Parameter Min–Max Values	85
Table 8—I	Recognized Limits in a Dual–Pressure Mixed–Mode Welding Cycle	89
Table 8—II	Recognized Limits in a Dual–Pressure Uniform–Mode Welding Cycle	89
Table 8—III	Recognized Limits in a Single–Pressure Welding Cycle	89
Table 10—I	Stud Torque Unit Conversions	108
Table 10—II	Horn/Booster Torque Unit Conversions	110
Table 15—I	DPC II Plus Generator Models and Power Supply requirements	149
Table 15—II	DPC EZ Generator Models and Power Supply requirements	149

This page intentionally left blank

User Supplied Circuitry

- Manual Control Switch
- Automation Control Switch
- Isolated Automation Control

Manual Switch Circuit	163
Automation Switch Circuits	164
Non-Isolated Switch Circuits	165
Current Sink	165
Current Source	166
Isolated Switch Circuit	167

This page intentionally left blank

Manual Switch Circuit

Figure C-1 is an example of a typical, user supplied manual control circuit connected to the DPC Control Input connector. The switch contacts are connected to the Switch Closure Input at Pin #8 or Pin #15 and DPC Ground at Pin #7 or Pin #2.

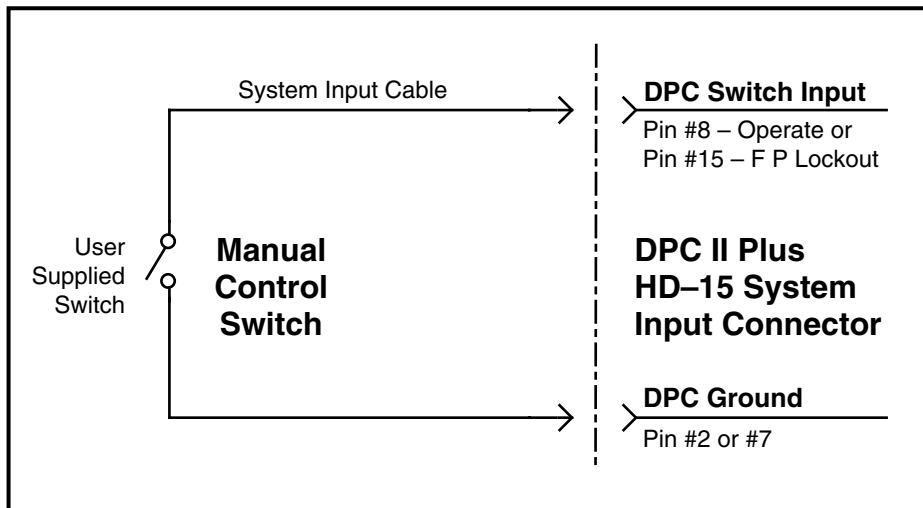

Figure C-1 Manual Control Switch

NOTE

The drawings and circuits shown in this section are intended solely for purposes of example. Since there are many variables and requirements associated with any particular installation, Dukane does not assume responsibility or liability for actual use based upon the examples shown in this section.

Automation Switch Circuits

Figure C–2 shows examples of various types of user supplied automation control circuits connected to the DPC Input. These examples can be used in place of the low–side or high–side switches in Figure C–3 and Figure C–4.

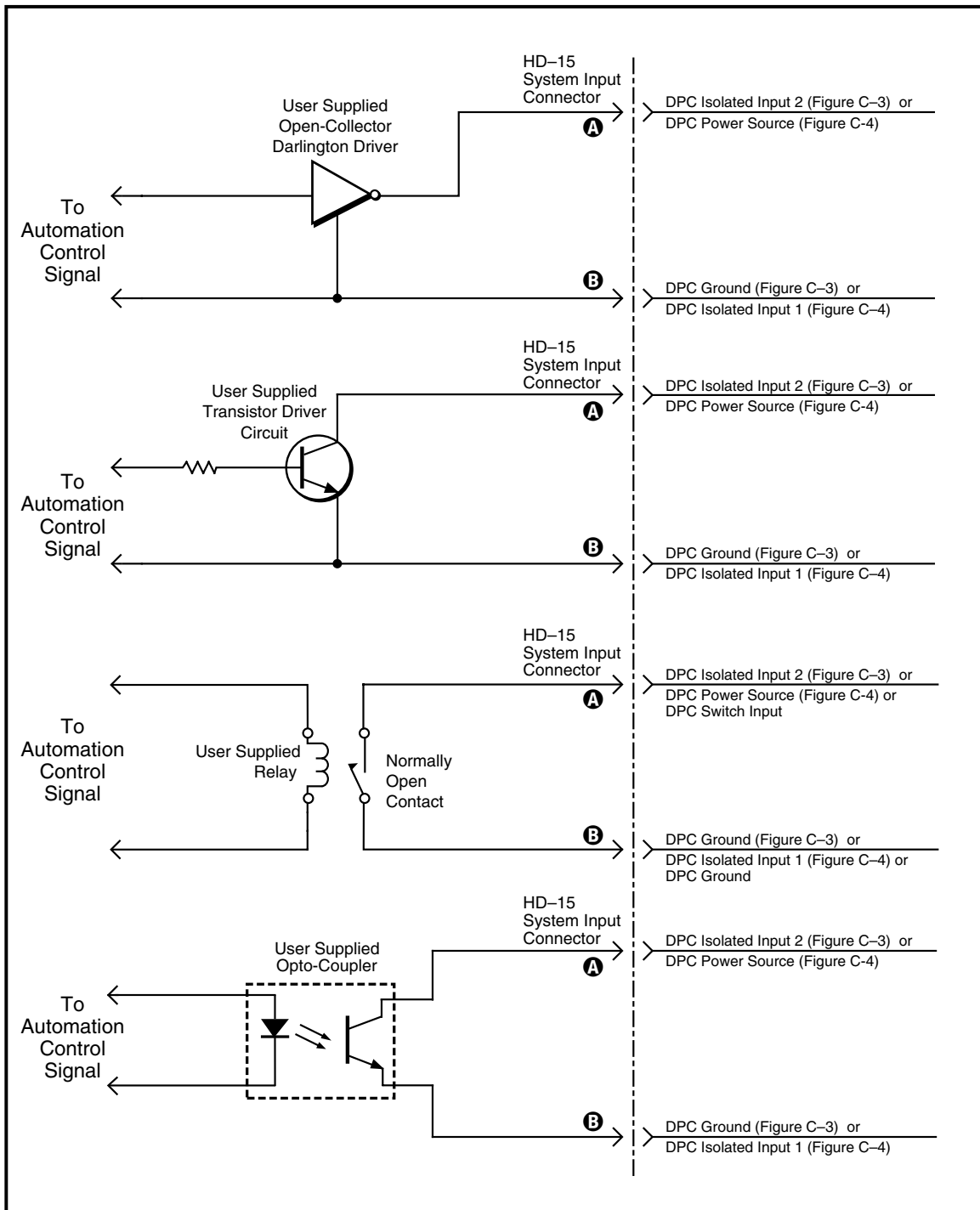

Figure C–2 Automation Control Switches

Non-Isolated Switch Circuits

Current Sink Control Circuit

Figure C-3 illustrates an automation control circuit connected to the low side of one of the Isolated Automation Inputs. Even though the switch drives an Opto-Isolator, it is still connected to DPC ground and not isolated. The SH707 jumper block is in the factory default position (JU724). Any of the examples in Figure C-2 can be used in place of the block labeled **Low Side Switch Sinks Current To Ground**.

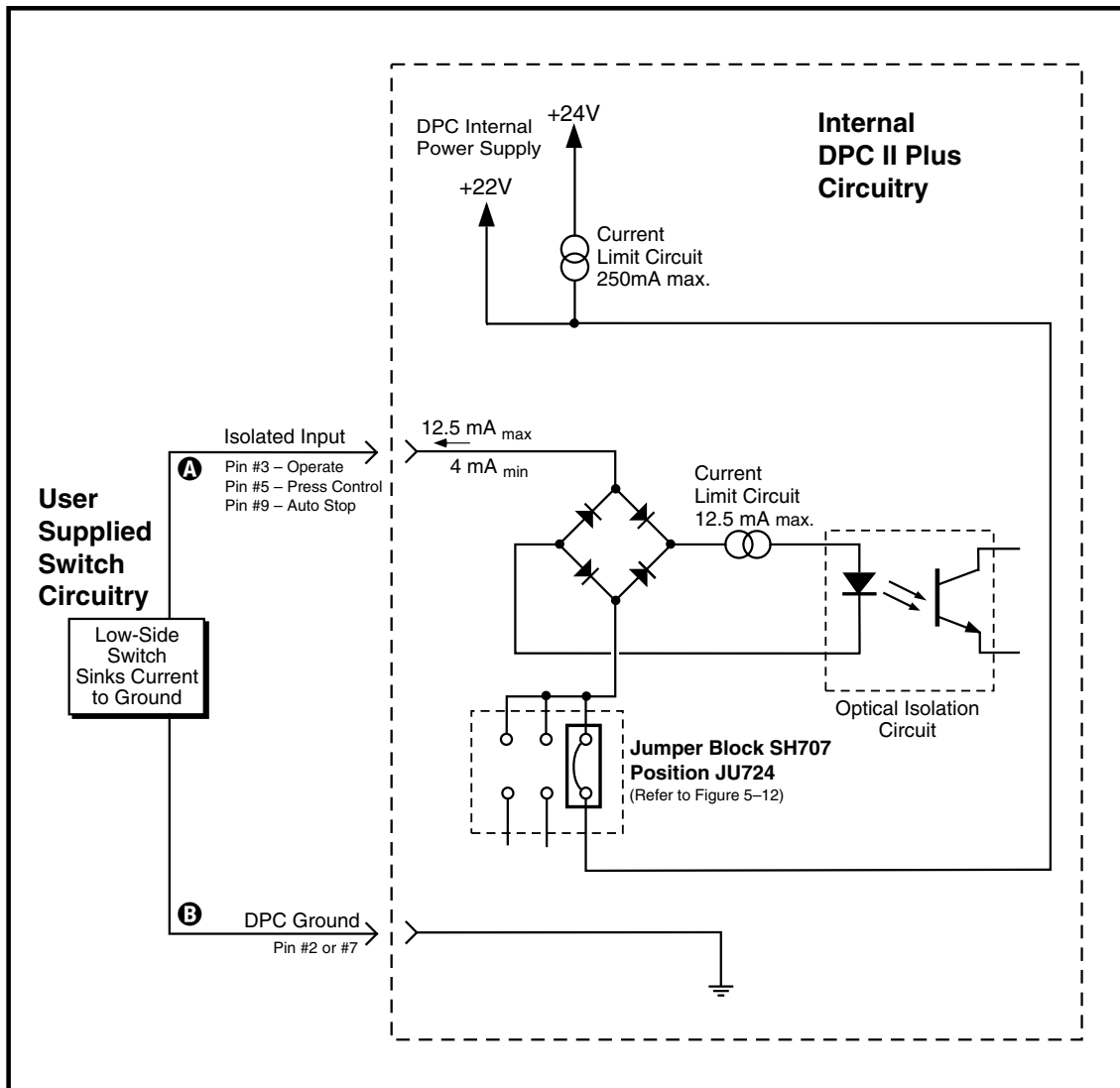

Figure C-3 Current Sink Switch

Current Source Control Circuit

Figure C-4 illustrates an automation control circuit connected to the highside of one of the Isolated Automation Inputs. Even though the switch drives an Opto-Isolator, it is still connected to the DPC power source and not isolated. The SH707 jumper block must be in the JU725 position (see Figure 5-12). Any of the examples in Figure C-2 can be used in place of the block labeled **High Side Switch Sources Current**.

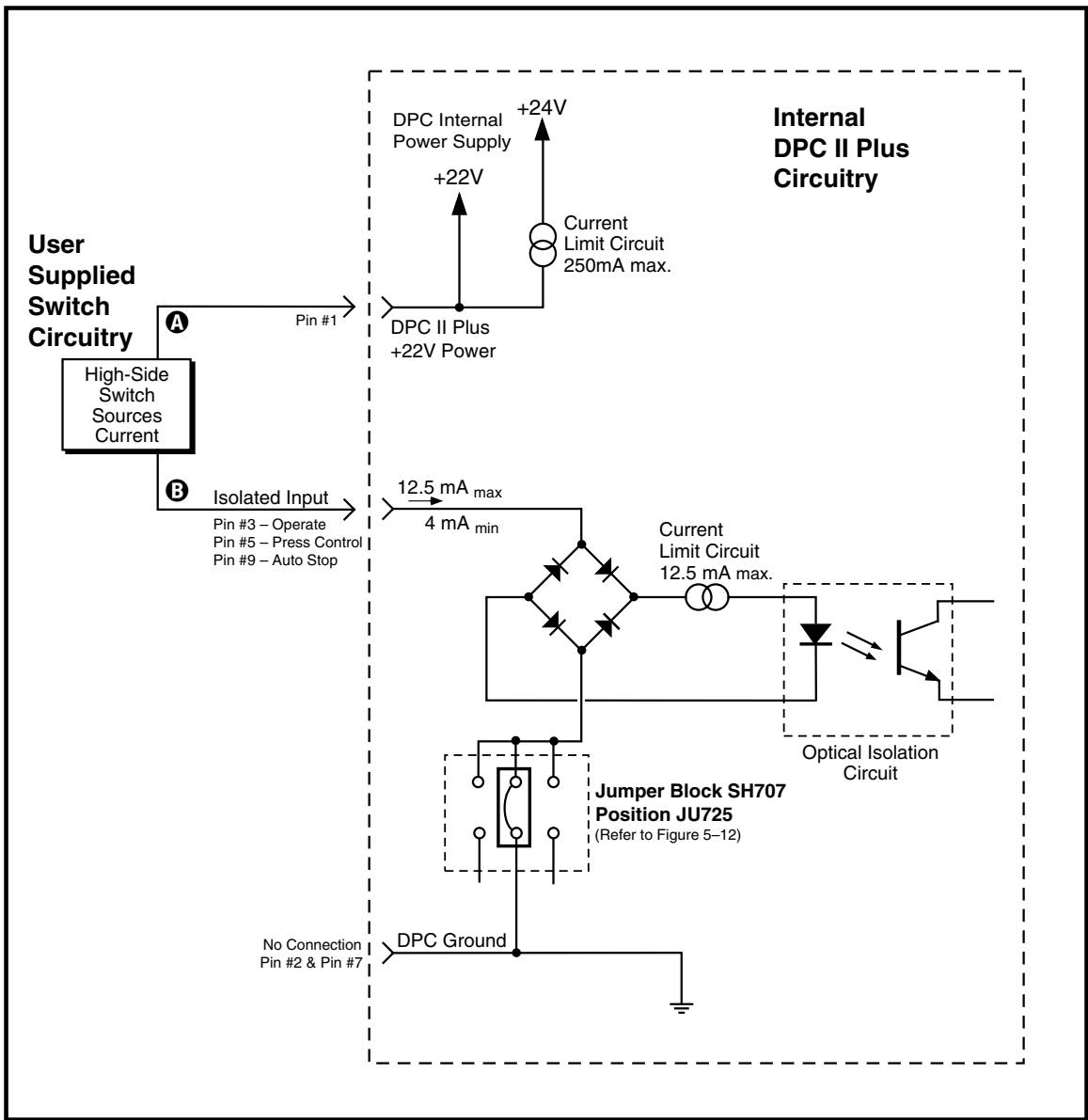

Figure C-4 Current Source Switch

Isolated Switch Circuit

Isolated Current Source Circuit

Figure C-5 illustrates a fully isolated circuit connected to the Isolated Automation Inputs. This requires an external power supply to drive the switch. The SH707 jumper block needs to be placed in the JU726 position (refer to Figure 5-12).

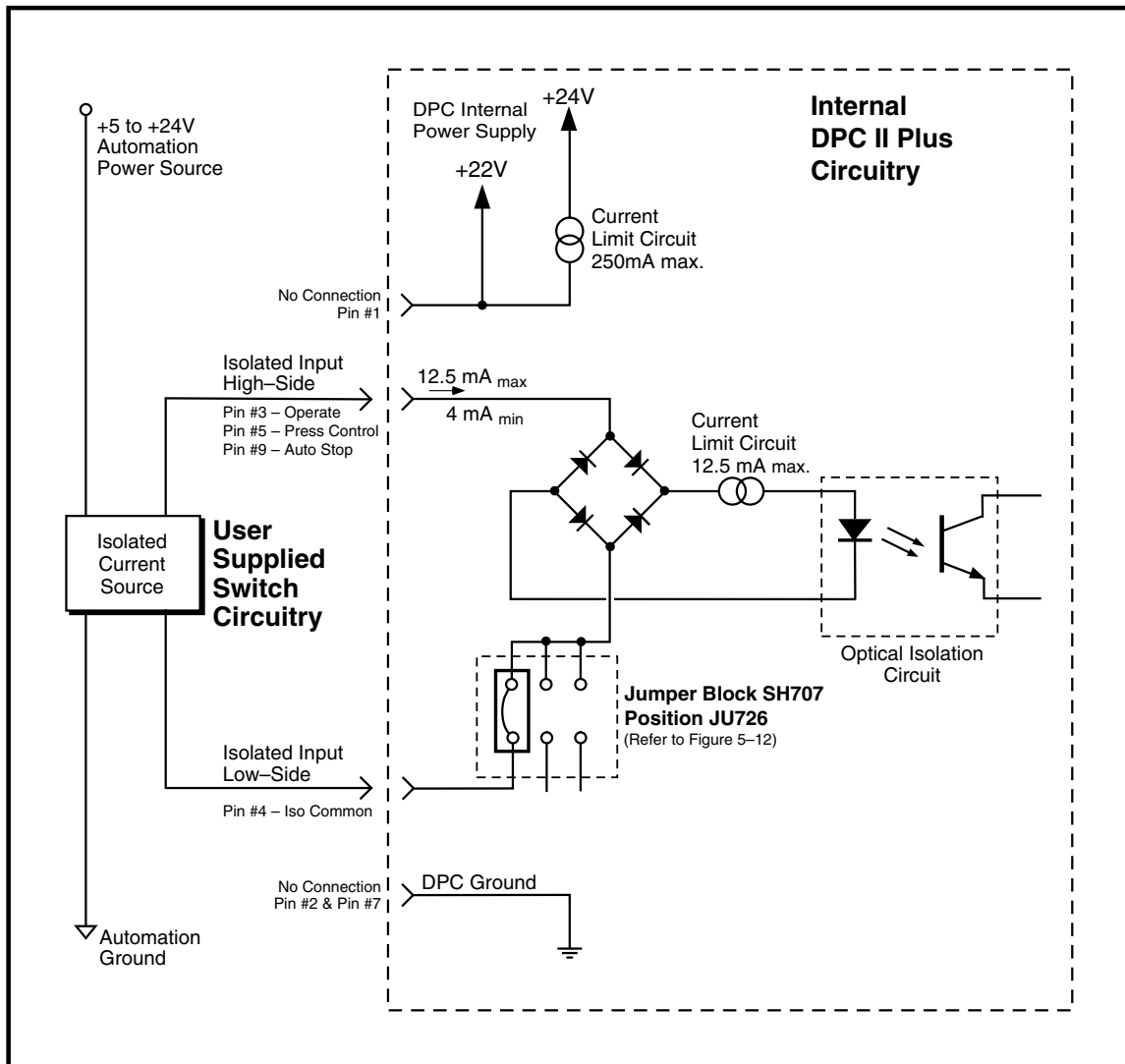

Figure C-5 Isolated Current Source

This page intentionally left blank

A

AC Power Indicator	29
AC Power Switch/Breaker	19, 25, 30, 39
AC Requirements	149
Afterburst	73–74, 80, 85
Air Circulation	17, 135
AMP. ADJUST Key	34, 82
Amplitude Adjust	82
Amplitude Control Module, Remote	46
Amplitude Monitor Output	32, 44
Arrow Keys	33–34
Auto Probe Mode Flowchart	72
Auto Probe, Afterburst	73
" " , Auto Stop Menu	72
" " , Data Entry	73–74
" " , Hold Time	73
" " , Maximum Weld Time	72
" " , Menu	72–73
" " , Timed	73
" " , Untimed	73
" " , Weld Method Menu	73
Auto Stop Enable	69
Auto Stop Menu	68, 72, 76
Automated Probe System	20
Automated Thruster System	23
Automation Circuits	163, 164
Automation Control Inputs	40–41
Automation Equipment	21
Auto–Trac Tuning	7

B

Bad Part Counter	100
Bad Part Limit	90
Bad Part Status Output	45
Base (Press) Input Cable	23–24, 48
Benchtop Placement	17
Booster	106
Booster Gain	114
Booster Notes	114
Booster Output End Geometry	114

C

Cable Color Code	41
Cable Connections	20–24, 40, 42, 47–49
Cable Part Numbers	21–24

Cable Schematics, System 21–24
 Cable Troubleshooting 125
 CANCEL Key 34, 74
 CE Compliance (Conformité Européene) 6, 8, 147
 Center Depression 137
 Chassis Maintenance 135
 Circuits, User Supplied 161–166
 Configuration Menu 57, 65
 Confirmation Screen 35
 Connectors, Identified 19, 39, 125
 Connector Pinouts 40, 42, 48–49, 126
 Controls, Front Panel 29
 Connectors, Rear Panel 19, 39, 40, 42, 125, 135
 Control Inputs 41
 Control Keys 30, 119–121, 128, 135
 Cooling Air Vents 17, 148
 Copy Setup 99
 Corrosion, Horn 137
 Counter Preset 101
 Counter Reset 100
 Crowning, Horn 137
 Current Loop Connector, 4–20 mA 46
 Current Loop Fault 44
 Current Loop Transfer Function 46
 Current Sink Circuit 165
 Current Source Circuit 166
 Cycle Press Off Line Menu 101

D

Data Entry Menu 35
 DB-25 Connector (System Output) 42
 Dimensions 148
 Decrement Key 34
 Display, Care of 135
 Display, Menu 29, 35
 Display, Status 31, 19–121
 Dwell Time (In-Dwell) Status Output 45
 Dual Pressure Mode 76
 Dukane Press System 24
 Dukane Website 143

E

Email Addresses, Dukane 144
 Emergency Stop Switch 20, 25, 119
 Energy, Welding By 70
 Energy, Definition 70
 Energy Limits 89
 Energy, Min–Max Values 85
 Energy Module see Power Signal Output Module

ENTER Key	34, 77
Enter New Setup	98
Erase Setups.....	99
Error Messages	92, 131
Example Setup.....	77–81
EZ Generator	8, 19–24, 29, 33, 39, 48–49, 149
F	
FAULT Status Display	31, 127
FCC Compliance.....	6, 147
Features of DPC II Plus	7
Flowcharts	59, 60, 66, 68, 72, 75, 83, 91, 93, 97, 129, 130
40kHz Considerations	106
Frequency Monitor Output	44
Front Panel Controls	29–30, 32–34, 119
Front Panel Control Lock	41, 120
Front Panel Displays.....	31–32
Front panel Maintenance	135
G	
GEN. INFO. Key	33
Good Part Status Output	45
Grounding	19, 22, 24, 135
Ground–Detect Fixture	70
Ground–Detect Weld Method.....	70
H	
Hand Probe	65, 105
Hand Probe Mode Flow Chart	66
Hand Probe, Data Entry.....	67
" " , Timed	66
" " , Trigger Method	66
" " , Untimed.....	66
" " , Weld Energy	67
" " , Weld Method	67
" " , Weld Time	67
" " , Weld Time, Maximum	67
HD–15 Connector (System Input)	40
Head Up On Auto Stop	76
Health and Safety Tips	11
HOLD Key	33, 81
Hold Time	73, 80, 85
Horn	106
Horn Assembly	112
Horn Contact Surfaces	136
Horn Corrosion	137
Horn Disassembly	111
Horn Resurfacing	138
Hot Keys.....	34, 81

I

- Increment Key 33
- In-Dwell Status Output 45
- Indicator, AC Power 19, 30
- Initiate Mode 76, 78
- Input Connector, System In 19, 39, 40, 125
- Input, Isolated 41, 69
- INPUT TEST Display 31, 119, 128
- INPUT TEST Status Display 31
- Internet Site 143
- Isolated Inputs 41, 69, Appendix C
- Isolated Outputs 42, 45, 101
- ISO 9001 Certification 8, Inside Rear Cover

J

- Joules, Definition 70
- Jumper Blocks, Internal 51–53, 69
- Jumper Block, Press Control Module 20, 119
- J901 Thruster Connector 48
- J902 Press Base Connector 48–49

K

- Key Features of DPC II Plus 7
- Keys, Control 30, 119–121, 128, 135
- Keys, Hot 34, 81
- Keys, Menu 29, 33–34, 77

L

- LCD Display 29, 35, 135
- Left Arrow Key 33
- Line Voltage Regulation 7
- Limit Definition Flowchart 60, 91, 93
- Limits, Bad 90
 - " , Data Entry 92
 - " , Dual Pressure Mode 92
 - " , Menu 90
 - " , Min–Max Values 89
 - " , Selection Criteria 90
 - " , Single Pressure Mode 91
 - " , Suspect 90
- Load Regulation 8

M

- Maintenance, Scheduled 111, 137
- Master MPC Module 50
- Mating Surfaces (Horn) 136
- Maximum Parameter Values 85
- Maximum Weld Energy 72, 75

Maximum Weld Time	67, 70, 71, 79
Menu, Confirmation	35
Menu, Data Entry	35
Menu, Selection	35
Menu Flowchart	59, 66, 68, 72, 75
Menu Keys	29, 33–34, 77
Model Number Coding	150
Mounted Probes	111
MODE Key	34, 74, 77
Mode Menu	75, 79
Model Number Tag Location	19
MPC Module	50
MPC Probe, Auto Stop Menu	68
" " , Data Entry	69–71
" " , Maximum Weld Time	70
" " , Weld Energy Menu	70
" " , Weld Method Menu	69
" " , Weld Time Menu	69
Multi-Probe Control Module	50
Multi-Probe Mode Flow Chart	68
Multiple Probe System Cabling	22
N	
Navigation Keys (Menu Keys)	29, 33–34, 77
O	
OFF LINE Status Display	31, 120
OFF LINE Key	30
ON LINE Status Display	31, 119
ON LINE Key	30, 119
Operational Checkout	119–120
Operating Conditions	148
Operational Control (Thruster) Cable	23–24, 49
OSHA Compliance	12
Output Connector, System Status	19, 39, 42
Output, Isolated	42, 45
OVERLOAD Status Display	31–32, 127
OVERLOAD Status Output	43
OVERTEMP Status Display	31, 127
OVERTEMP Status Output	43
P	
Parameter Values, Min–Max	85
Part Count, Count Sus/Bad Part	100
" " , Menu	100
" " , Preset	101
Part Count, Reset	100
Placement of DPC	17

Plug-and-Weld 7

Power, Definition 70

Power Indicator, AC 29, 30

Power Output Display 29, 32

Power Output Module 47

Power Signal Output Monitor 44

Power Switch, AC 25, 30

Power Requirements, AC 149

Press Base Cable Connector 23–24, 48, 119

Press Control Module 48, 119

Press Emergency Stop Switch 101, 119

Press Mode Flowchart 75

Press Mode, Afterburst 80

 " " , Auto Stop Menu 76

 " " , Data Entry 78–80

 " " , Head Up On auto Stop 76

 " " , Hold Time 80

 " " , Initiate Mode 76, 78

 " " , Maximum Weld Time 79

 " " , Trigger Method 77

 " " , Trigger Type 76, 78

 " " , Weld Method 78, 79

 " " , Weld Mode 76, 78, 79

Press Operate Palm Switches 101

Press Setup, Example Program 77–81

Press System Cabling 24

Probe, Auto Menu 65

 " , Hand Menu 72

 " , ID Selection Bits 40

 " , Maintenance 136

 " , MPC Menu 68

 " , Operation 121

 " , Stacks 107–112

 " , Stack Mounting 115

 " , Time Delay Menu 69

 " , Troubleshooting 125

Process Control Flowchart 59

 " " Menu 58–59, 65–66, 84

 " " Trigger Method Menu 66

Process Limits Menu 60, 90

Process Setup Flowchart 58, 74

Process Setup Menu 57, 66, 77

Programming Port, Serial 19

Pulse Width Modulation 7

R

Rack Mounting DPC 18

Ready Status Output 45

Rear Panel Connectors 19, 39, 125

Rear Panel Layout	19, 39
Remote Amplitude Control Module	46
Replaceable Tips	107, 113
Resurfacing, Horn	138–139
RFI Considerations	13
Right Arrow Key	34
RS-232 Serial Port	19
S	
Safety Tips	11
Save Setups	98
Scheduled Maintenance	111, 137
Scrub Time	71, 85
Select Setup	98
Selection Menu	35
Self Test	119
Setup Files, Remote Selection	40
Setup Utilities Menu	98
Setup, Copy	99
" , Erase	99
" , Select	98
" , Types (Remote)	98
Serial Number Location	19
Serial Programming Port	19
Slave MPC Module	50
Single Pressure Mode	76
Software Version	33
Specifications	148–149
Stack Assembly	109
Stack Inspection	136
Stack Maintenance	136
Startup Screen	57, 65
Status Display	29, 31
Status Driver Selection Jumper	51
Status Output Signals	42–45
Status Output Menu	101
Status Output, Maintained/Pulsed	101
Status Panel	30
Stopping The Weld Cycle	121
Storage Conditions	148
Studs, Horn & Booster	108
Suspect Part Count	100
Suspect Part Limit	90
Switch Circuits, User Supplied	161–166
System Cabling	21–24, 119
" Control Input Jumper	52
" Input Connector	19, 39, 40, 125
" Input Signal Descriptions	41
" Fault Status Output	43

System Output Connector 19, 39, 42
 “ Power Output Display 32
 “ Test 120

T

Theory of Operation 105
 Telephone Numbers, Dukane 144
 Test, Self 119
 Test, System 120
 TEST Key 30, 120, 128
 TEST, F P Lock 41, 120
 Thruster Cable Connector 23–24, 48–49
 Time Delay Menu, Probe 69
 Time, Maximum Weld 67, 70, 71, 79
 Time, Welding By 67, 69
 Timed Probe 66, 73
 Tips, Replaceable 107, 113
 Titanium 106
 Top of Stroke 23
 Torque Specifications 107–108, 110
 Torque Units Conversion 110
 Trigger Method Menu 66, 75, 77
 Trigger Type Menu 76, 78
 Troubleshooting 125–131

U

Ultrasonic Output Connector 19, 39, 125
 Ultrasonic Welding, Theory of 105
 Universal Power Supply 8
 Untimed Probe 66, 73
 Utilities Menu 61, 98
 Utilities Flowchart 61, 97

V

Values, Parameter Min–Max 85
 Vents, Cooling Air 17, 31, 135, 148
 Vise, Booster Clamping 113
 Version of DPC Firmware 57

W

Warranty, Domestic 153
 Warranty, International 154
 Warranty, Tooling 154
 Website, Dukane 143
 Weld By Energy 70
 Weld By Time 67, 69

Weld Cycle Data	57, 65, 81
Weld Energy	67, 70, 79
Weld Method	67, 69, 78
Weld Mode	75, 79
WELD P1 Key	33, 82
WELD P2 Key	34, 82
Weld Time	67, 69, 78
Weld Time Min–Max Values	85
Weld Time Limits	89
Wrench, Horn & Booster	107

This page intentionally left blank

Dukane ISO

ISO CERTIFICATION

Dukane chose to become ISO 9001:2000 certified in order to demonstrate to our customers our continuing commitment to being a quality vendor. By passing its audit, Dukane can assure you that we have in place a well-defined and systematic approach to quality design, manufacturing, delivery and service. This certificate reinforces Dukane's status as a quality vendor of technology and products.

To achieve ISO 9001:2000 certification, you must prove to one of the quality system registrar groups that you meet three requirements:

1. Leadership
2. Involvement
3. Quality in Line Organizations and Quality System Infrastructure.

The ISO 9001:2000 standard establishes a minimum requirement for these requirements and starts transitioning the company from a traditional inspection-oriented quality system to one based on partnership for continuous improvement. This concept is key in that Dukane no longer focuses on inspection, but on individual processes.

Dukane's quality management system is based on the following three objectives:

1. Customer oriented quality. The aim is to improve customer satisfaction.
2. Quality is determined by people. The aim is to improve the internal organization and cooperation between staff members.
3. Quality is a continuous improvement. The aim is to continuously improve the internal organization and the competitive position.



DUKANE CORPORATION

WHO ARE WE?

We are plastic welding technologists. We are scientists.
We are employees and businessmen. We are instructors.

We are engineers. We are specialists in electronics
and experts in plastic assembly. We are salesmen. We do
basic research and we manufacture machines.

We are problem solvers and we are technical advisors

We Are Your Partners.

REGIONAL OFFICES

① **Northeast Region**
Rocco Telese
14 Delmar Drive – Suite 6B
Brookfield, CT 06084
(203) 740-0089

② **Central Region**
Jason Barton
4424 Aicholtz Road – Suite G
Cincinnati, OH 45245
(513) 752-8803

③ **Automotive Region**
Raymond LaFlamme
11235 Stark Road
Livonia, MI 48150
(734) 513-4038

④ **Midwest Region**
Vasko Naumovski
2900 Dukane Drive
St. Charles, IL 60174
(630) 797-4921

⑤ **Western Region & Alaska**
James Jackstein
162 East Manilla Drive
Draper, UT 84020
(801) 523-6191

⑥ **Mexico, Canada & Caribbean**
Nelson Romero
2900 Dukane Drive
St. Charles, IL 60174
(630) 797-4915

§ **Mexico Serv. Cntr.**
Alejandro (Alex) Juarez
Santa Gertrudis No. 1223
Col. La Purisima
Guadalupe NL CP 67129 Mexico
011-52-81-8298-3276

☼ Corporate Office and Training Center
☆ Regional Office
▲ Application Laboratory
§ Service Center

User's Manual – DPC II Plus and EZ Welder System

Part No. 403-566-01



\$100.00



www.dukcorp.com/us

Printed in the United States of America

Dukane Corporation • Ultrasonics Division • 2900 Dukane Drive • St. Charles, Illinois 60174 USA • TEL +1-630-797-4900 • FAX +1-630-797-4949

Free Manuals Download Website

<http://myh66.com>

<http://usermanuals.us>

<http://www.somanuals.com>

<http://www.4manuals.cc>

<http://www.manual-lib.com>

<http://www.404manual.com>

<http://www.luxmanual.com>

<http://aubethermostatmanual.com>

Golf course search by state

<http://golfingnear.com>

Email search by domain

<http://emailbydomain.com>

Auto manuals search

<http://auto.somanuals.com>

TV manuals search

<http://tv.somanuals.com>