

DURABRAND

MODEL PDV-722

Dual Screen Portable DVD Player

Instruction Manual



- **Plays DVDs, Audio CDs, CD-R/RW, MP3 CDs and Picture CDs**
- **Includes Car Headrest Mounting Straps for Car use**
- **Built-in Rechargeable Battery for Portable Use Anywhere**
- **Includes AC Adaptor for Home Use (universal voltage)**
- **Includes Car Adaptor for Travel**
- **Connects to Your Larger Screen Home TV (cable included)**
- **Includes Carrying / Storage Case**

PLEASE READ CAREFULLY BEFORE USE

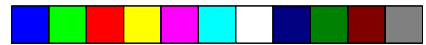

IB-PDV722-WM-E-012007



SAFETY INSTRUCTIONS

WARNING

TO PREVENT FIRE OR SHOCK HAZARD, DO NOT USE THE PLUG WITH AN EXTENSION CORD, RECEPTACLE OR OTHER OUTLET UNLESS THE BLADES CAN BE FULLY INSERTED TO PREVENT BLADE EXPOSURE. TO REDUCE THE RISK OF FIRE OR ELECTRIC SHOCK, DO NOT EXPOSE THIS APPLIANCE TO RAIN OR MOISTURE. TO PREVENT ELECTRICAL SHOCK, MATCH WIDE BLADE PLUG TO WIDE SLOT, FULLY INSERT.

 <p>The lightning flash with arrowhead symbol, within an equilateral triangle, is intended to alert the user to the presence of uninsulated "dangerous voltage" within the product's enclosure that may be of sufficient magnitude to constitute a risk of electric shock to persons.</p>	<p style="text-align: center;">CAUTION</p> <p style="text-align: center;">RISK OF ELECTRIC SHOCK DO NOT OPEN</p> <p>WARNING: TO REDUCE THE RISK OF ELECTRIC SHOCK, DO NOT REMOVE COVER (OR BACK). NO USER SERVICEABLE PARTS INSIDE. REFER SERVICING TO QUALIFIED SERVICE PERSONNEL.</p>	 <p>The exclamation point within an equilateral triangle is intended to alert the user to the presence of important operating and maintenance (servicing) instructions in the literature accompanying the appliance.</p>
--	---	--

Rating plate and caution marking are marked on the back enclosure of the apparatus.

IMPORTANT SAFETY INSTRUCTIONS

1. Read these instructions.
2. Keep these instructions.
3. Heed all warnings.
4. Follow all instructions.
5. Do not use this apparatus near water.
6. Clean only with dry cloth.
7. Do not block any ventilation openings, install in accordance with the manufacturer's instructions.
8. Do not install near any heat sources such as radiators, heat registers, stoves, or other apparatus (including amplifiers) that produce heat.
9. Do not defeat the safety purpose of the polarized or grounding-type plug. A polarized plug has two blades with one wider than the other. A grounding type plug has two blades and a third grounding prong. The wide blade or the third prong are provided for your safety. If the provided plug does not fit into your outlet, consult an electrician for replacement of the obsolete outlet.
10. Protect the power cord from being walked on or pinched particularly at plugs, convenience receptacles, and the point where they exit from the apparatus.
11. Only use attachments/accessories specified by the manufacturer.
12. Unplug this apparatus during lightning storms or when unused for long periods of time.
13. Refer all servicing to qualified service personnel. Servicing is required when the apparatus has been damaged in any way, such as power-supply cord or plug is damaged, liquid has been spilled or objects have fallen into the apparatus, the apparatus has been exposed to rain or moisture, does not operate normally or has been dropped.
14. This appliance shall not be exposed to dripping or splashing water and that no object filled with liquid such as vases shall be placed on the apparatus.





SAFETY INSTRUCTIONS Continued

Do not apply oil or petroleum products or solvents to any part of this set.

FCC NOTE

This device complies with Part 15 of the FCC Rules. Operation is subject to the following two conditions: (1) This device may not cause harmful interference, and (2) This device must accept any interference received, including interference that may cause undesirable operation.

WARNING:

Changes or modifications to this unit not expressly approved by the party responsible for compliance could void the user's authority to operate the equipment.

NOTE:

This equipment has been tested and found to comply with the limits for a Class B digital device, pursuant to Part 15 of the FCC rules. These limits are designed to provide reasonable protection against harmful interference in a residential installation. This equipment generates, uses and can radiate radio frequency energy and, if not installed and used in accordance with the instructions, may cause harmful interference to radio communications. However, there is no guarantee that interference will not occur in a particular installation. If this equipment does cause harmful interference to radio or television reception, which can be determined by turning the equipment off and on, the user is encouraged to try to correct the interference by one or more of the following measures.

- Reorient or relocate the receiving antenna.
- Increase the separation between the equipment and receiver.
- Connect this equipment into an outlet on a circuit different from that to which the receiver is connected.
- Consult the dealer or an experienced radio/TV technician for help.

LISTENING CAUTION

For your comfort, health and safety, be sure to observe the following guidelines when you listen to the music using the headphones.

1. Do not play your DVD player at a high volume. Hearing experts advise against continuous extended play.
2. If you experience a ringing in your ears, reduce the volume or discontinue use.
3. Do not use while operating a motorized vehicle. It may create a traffic hazard and is illegal in many areas.
4. You should use extreme caution or temporarily discontinue use in potentially hazardous situations.
5. Even if your headphones are the open-air type designed to let you hear outside sounds, do not adjust the volume too high so that you can hear what is around you.
6. Sounds can be deceiving. Over time your hearing "comfortable level" adapts to higher volumes of sound. So what sounds "normal" can actually be loud and harmful to your hearing. Guard against this by setting your equipment at a safe level before your hearing adapts.

TO ESTABLISH A SAFE LEVEL:

- Start your volume control at a low setting.
- Slowly increase the sound until you can hear it at a comfortable and clear level, and without distortion.

Once you have established a comfortable sound level: Leave it there.





SAFETY INSTRUCTIONS

Continued

NOTE

This product incorporates copyright protection technology that is protected by method claims of U.S. patent numbers 4,631,603; 4,819,098; 4,907,093; 5,315,448; and 6,516,132 and other intellectual property rights owned by Macrovision Corporation and other rights owners. Use of this copyright protection technology must be authorized by Macrovision Corporation, and is intended for home and other limited viewing uses only, unless otherwise authorized by Macrovision Corporation. Reverse engineering or disassembly is prohibited.

CAUTION

Use of controls or adjustments or performance of procedures other than those specified herein may result in hazardous radiation exposure. Do not open covers and do not repair yourself. Refer servicing to qualified personnel. This DVD VIDEO player is classified as CLASS 1 LASER PRODUCT as stated on the back of the set.

INCLUDED ACCESSORIES

The following items are included with your DVD player:

- Remote Control
- AAA Batteries (2)
- AC adaptor
- Car adaptor
- DC power cord
- Audio/Video cable
- Carrying / Storage case
- Car headrest Mounting strap (2 sets)
- User's Guide
- Product Registration Card



TABLE OF CONTENTS

- **Getting Started:**
 - Safety Instructions 1
 - Included Accessories 3
 - Controls Overview 5
 - Power Supply 9
 - Remote Control Operation 11
 - System Connections 12
 - Installing the DVD Player in Your Car 14
 - Notes on Discs 15
- **Basic Operation:**
 - 1. Playing a Disc 16
 - 2. Using the Search Function 17
 - 3. Selecting Audio Mode 17
 - 4. Changing Subtitle Language 17
 - 5. Displaying Disc Information 18
 - 6. Repeat Play 18
 - 7. Search for Preferred Play 19
 - 8. Slow-Motion Play 20
 - 9. Zoom Play 20
 - 10. Viewing Angle Shots 20
 - 11. MP3 Disc Operation 21
 - 12. CD Programmed Play 21
 - 13. JPEG or Picture Disc Operation 22
- **Watching a DVD on Your TV** 23
- **Initial Setting:**
 - System Setup (TV System, LCD Mode, Sleep Control, TV Type, & Default)
 - Setting the TV System 24
 - Setting the LCD Mode 24
 - Setting the Sleep Control 24
 - Selecting the TV Type 25
 - Default - Resetting the Functions to Factory Defaults 25
 - Language Setup (OSD, Audio, Subtitle & Menu) 26
 - Audio Setup 26
 - Video Setup 26
- **Precautions** 27
- **Trouble Shooting** 28
- **Glossary** 31
- **Specifications** 32



CONTROLS OVERVIEW

Main unit

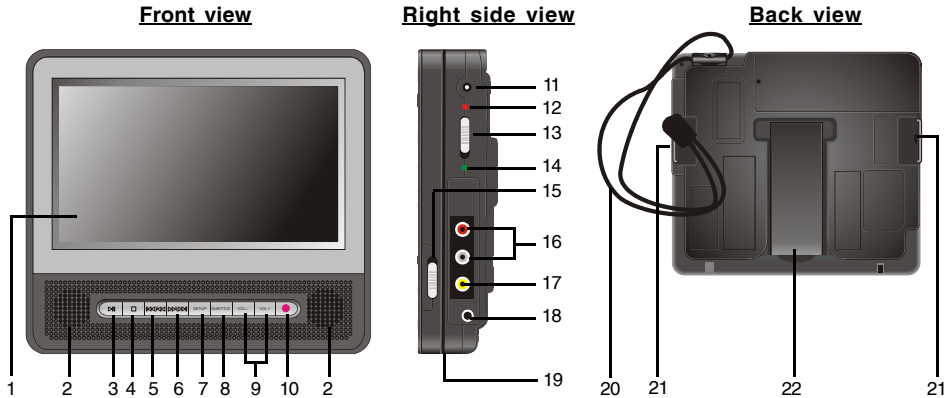

1. **TFT LCD SCREEN** – Provides a high resolution picture.
2. **SPEAKERS** – Provide stereo sound.
3. **PLAY/PAUSE BUTTON** **▶▶** – Press to start or pause play.
4. **STOP BUTTON** **■** – Stops playback, press twice for full stop.
5. **SKIP/SEARCH BACKWARD** **◀◀/◀** – Press to skip to the previous title, chapter or track. Press and hold to scan backwards.
6. **SKIP/SEARCH FORWARD** **▶▶/▶** – Press to skip to the next title, chapter or track. Press and hold to scan forwards.
7. **SETUP BUTTON** – Press to display the DVD player's setup menu.
8. **SUBTITLE BUTTON** – Press to select or change the subtitles (if available on your disc).
9. **VOLUME BUTTONS** – Press to adjust the volume.
10. **REMOTE SENSOR** – Receives signals from the remote control.
11. **DC IN JACK** – For connecting to the supplied AC adaptor or car adaptor or the DC power cord when the slave set is in use.
12. **BATTERY LED INDICATOR** – This set has a inside rechargeable battery on the main unit, The battery LED indicator will flash when the battery is charging and remain steadily on when the battery is fully charged.
13. **POWER ON/OFF SWITCH** – Slide to switch the DVD player ON or OFF.
14. **POWER INDICATOR** – Will light up when the set is on.
15. **DISPLAY ON/OFF BUTTON** – Slide to turn on or turn off the main set screen but keeps the set working for viewing DVDs on your TV or the slave set.
16. **AUDIO OUT JACKS** – Connect the DVD player to the slave set or your TV or home theater system using the supplied audio cable.
17. **VIDEO OUT JACK** – Connects the DVD player to the slave set or your large screen TV using the supplied video cable.
18. **PHONES JACK** – Insert your headphones (not included) to enjoy the sound without disturbing others.
19. **OPEN AREA (at the front of the set)** – Open here to insert a disc.
20. **SAFETY CORD** – This is a backup hanging cord should the mounting band open accidentally.
21. **CAR HEADREST MOUNTING STRAP SLOTS** – For attaching the car headrest mounting strap to the set.
22. **DESK BRACKET** – Open this for desk use.

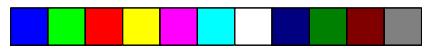

CONTROLS OVERVIEW

Slave unit

NOTE: The slave unit is only a second screen with speakers. All adjustments (except for picture and volume) can only be done on the main unit.

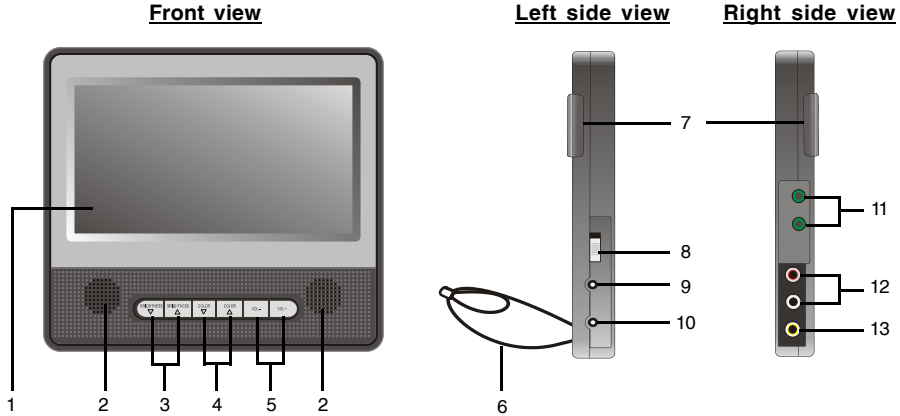

1. **TFT LCD SCREEN** – Provides a high resolution picture.
2. **SPEAKERS** – Provide stereo sound.
3. **BRIGHTNESS BUTTONS** – Press to adjust the brightness of the slave unit.
4. **COLOR BUTTONS** – Press to adjust the color of the slave unit
5. **VOLUME BUTTONS** – Press to adjust the volume.
6. **SAFETY CORD** – This is a backup hanging cord should the mounting band open accidentally.
7. **CAR HEADREST MOUNTING STRAP SLOTS** – For attaching the car headrest mounting strap.
8. **POWER ON/OFF SWITCH** – Slide to switch the slave unit ON or OFF.
9. **DC IN JACK** – For connecting to the supplied AC adaptor or car adaptor, so that the slave unit has power and then can provide power to the main unit and the two units can work together.
10. **DC OUT JACK** – For connecting to the main unit's DC IN jack using the supplied DC power cord.
11. **PHONES JACKS** – Insert your headphones (not included) to enjoy the sound without disturbing others. This slave unit allows two people to listen to the sound through their headphones at the same time.
12. **AUDIO IN JACKS** – Connect to the main unit using the supplied audio cable for sound.
13. **VIDEO IN JACK** – Connects to the main unit using the supplied video cable for picture.



CONTROLS OVERVIEW

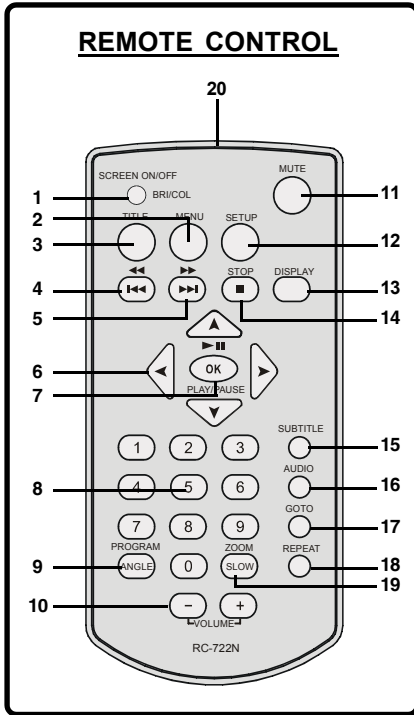

1. **SCREEN ON/OFF button** – Press and hold this button to turn the LCD screen ON or OFF (for external TV use only). Also to adjust the color or brightness level of the LCD screen, press this button to display the LCD screen color or brightness function, then press the left or right direction button to adjust the level up or down.
2. **MENU button** – Press to display the disc's menu (only if your disc has a menu).
3. **TITLE button** – Displays the title menu (only if it is present on the disc).
4. **◀◀/▶▶ button** – Press to skip to previous title, chapter or track / press and hold more than 1 second to scan backward.
5. **▶▶/▶▶ button** – Press to skip to next title, chapter or track / press and hold more than 1 second to scan forward.
6. **DIRECTION buttons** – Used in DVD menus & audio MP3 track selection.
7. **OK button** – Press to start/pause play or confirm (enter) a selection or command.
8. **NUMERIC buttons** – Used in DVD menus & audio CD/MP3 track selection.
9. **ANGLE / PROGRAM button** – In DVD mode, press to display angle menu (if present on the DVD disc); Press to program your favorite track in CD mode.

10. **VOLUME buttons** – Press to adjust the volume level (remember to also adjust your TV's volume).
11. **MUTE button** – Instantly turns off the sound, press again to restore the sound.
12. **SETUP button** – Press to display the DVD player's setup menu.
13. **DISPLAY button** – Press this button to view the elapsed time, title or chapter information and the track numbers during play.
14. **STOP button** – Stops play, press twice to full stop.
15. **SUBTITLE button** – Press to setup the subtitle (if available on your disc).
16. **AUDIO button** – Press to select the desired audio channels.
17. **GOTO button** – Allows you to select the desired disc starting time, track or title for playback.
18. **REPEAT button** – Press this button to repeat the current track, chapter, title, a chosen section (A to B), or all of the disc.
19. **ZOOM/SLOW button** – Press to zoom (enlarged) the playing picture in DVD mode or hold more than 1 second to view slow motion playback.
20. **REMOTE CONTROL lens** – Sends the signal to the set. Do not block or cover this, keep this clean for best operation.

NOTE 1: The remote control will only work on the main unit.

NOTE 2: Power is controlled by POWER switches on the main unit and the slave unit only, not by remote.



CONTROLS OVERVIEW

Other included accessories



AC adaptor, for home use.



Car power adaptor, for car use.



Carrying case with three compartments, left and right are for main and slave units, the middle compartment is for accessories and cables.



Audio / video cable, to connect main and slave units, or main unit and your TV set.



DC power cord, to connect the main and slave units for power.



2 sets car headrest mounting straps, for mounting the DVD players to your car headrest's back.



2 AAA alkaline batteries for remote control.



POWER SUPPLY

You can power this dual screen portable DVD player by connecting the AC adaptor, the car adaptor or by using the internal rechargeable battery.

A. Using the AC adaptor

This player is supplied with an AC adaptor for powering the unit and charging the battery. This adaptor works with any household voltage (even overseas) from 100 volts to 240 volts.

1. Viewing movies only on the main unit

Insert the AC adaptor plug to the DC IN jack on the main unit and connect the adaptor to a wall outlet.

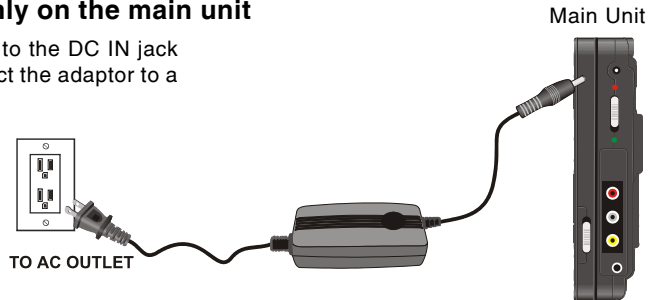

2. Viewing movies on the main unit and the slave unit at the same time

Insert the AC adaptor plug to the DC IN jack on the slave unit and connect the adaptor to a wall outlet. Insert one end of the supplied DC power cord to the slave unit's DC OUT jack and the other to the main unit's DC IN jack.

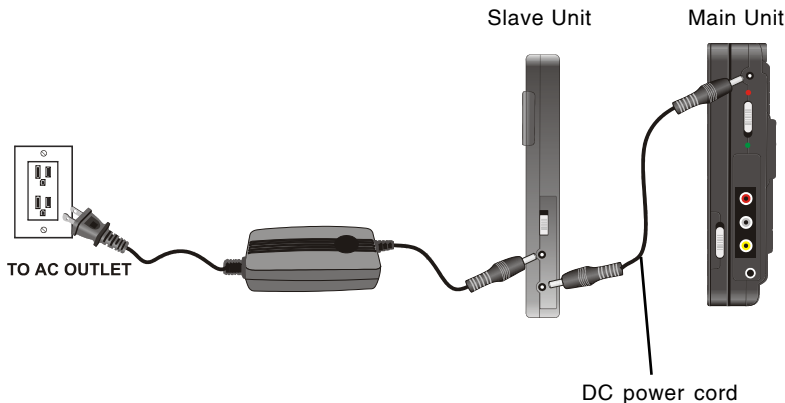



POWER SUPPLY

B. Using the car adaptor (12V)

This player is supplied with a 12V car adaptor for powering the unit and recharging the battery while in a vehicle that has a 12V power system.

1. Viewing movies only on the main unit

Insert the car adaptor plug to the DC IN jack on the main unit and connect the car adaptor to the vehicle's 12V accessory / cigarette lighter socket, the car adaptor indicator will light up.

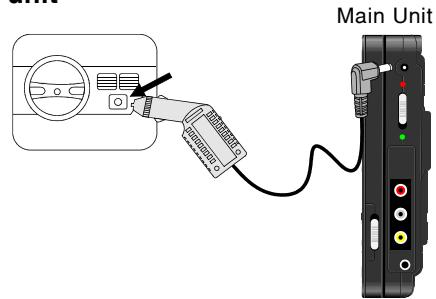

2. Viewing movies on the main unit and the slave unit at the same time

Insert the car adaptor plug to the DC IN jack on the slave unit and connect the car adaptor to the vehicle's 12V accessory / cigarette lighter socket, the car adaptor indicator will light up. Insert one end of the supplied DC power cord to the slave unit's DC OUT jack and the other to the main unit's DC IN jack.

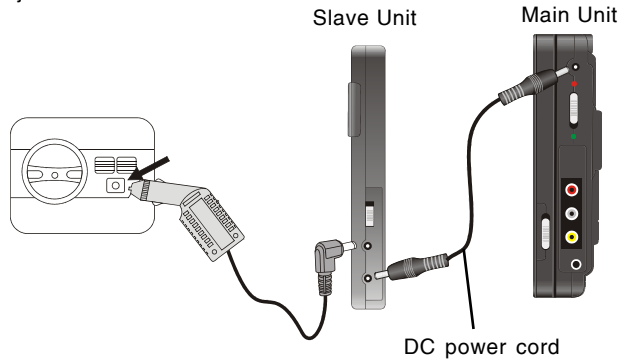

CAUTION:

1. The included car adaptor is for use with this unit only. Do not use it with other equipment.
2. Use this unit only with the included car adaptor, using with other car adaptors could damage the unit and the unit may not work.
3. Do not operate this unit or view video movies while driving a vehicle.
4. If some lines appear on the screen during the startup of the vehicle, please turn the unit off and turn it on again after the vehicle is running.
5. Place the unit in a proper position for viewing.
6. When the inside of the cigarette lighter socket is dirty with ashes or dust, the plug section may become hot or not work due to poor contact. Be sure to clean the cigarette lighter socket before use.
7. Disconnect the car adaptor from both the unit and the cigarette lighter socket when the battery is fully charged and the unit is not in use.



C. Using the built-in rechargeable battery

The built-in rechargeable battery is suitable for portable use which allows you to enjoy the unique functions of the main unit outdoors.

Remember to charge the battery fully before initial use (about 5 hours).

NOTE: The built-in rechargeable battery only provides power to the main unit. The slave unit cannot play on the built-in rechargeable battery.

To charge the battery

1. Connect the DVD player and the power source as point A and point B on the previous pages. After 5 seconds, the battery LED indicator will turn on and start to flash.
2. The battery LED indicator will flash when the battery is charging and remain steadily on when the battery is fully charged.
3. Charging time is about 5 hours. A fully charged battery delivers about 2.5 hours of viewing time.
4. When the battery is weak, the low power icon “” will appear on the LCD screen and after that the power automatically turns off. If this occurs, please use the AC adaptor or car adaptor to recharge the battery or play the set on AC power.

REMOTE CONTROL OPERATION

1. Push the tab to open the battery cover.

2. Insert 2 size “AAA” alkaline batteries (included) into the battery compartment according to the + and – markings inside the battery compartment, then replace the battery cover.

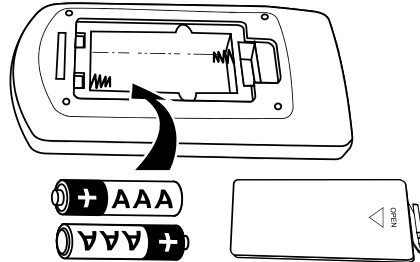

NOTE:

- Point the remote control unit from less than 20 feet (6 m) from the remote sensor and within about 60° of the front of the unit.
- Batteries should be changed by an adult for safety.
- Reversing polarities will damage the batteries and possibly your remote. Be sure to follow polarities (+ and –) as indicated.
- Do not mix different types of batteries together (Alkaline, Carbon-Zinc, Nickel-Cadmium etc.), or old batteries with new ones.
- When the batteries have become discharged, they must be disposed of in a safe manner that complies with all applicable laws.
- When the batteries becomes weak, the operating distance of the remote control decreases and you will need to replace the batteries.
- When the remote control is not to be used for a long time (2 months or more), remove the batteries to avoid possible damage that may be caused by battery leakage.
- Avoid keeping the remote control in extremely hot or humid locations.
- Do not point bright lights at the remote control sensor (like laser pointers).
- Do not place objects between the remote control unit and the remote control sensor.
- Do not use this remote control while using the remote control unit of any other equipment at the same time, the signals may mix.

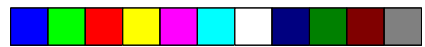

SYSTEM CONNECTIONS

If you just want to view movie on the main unit, after power connection, please go to page 16 to start play.

1. Connecting the main unit and the slave unit

If you want to view movie on the main unit and the slave unit together, after power connection, please also connect the main unit and slave unit's AUDIO, VIDEO jacks using the supplied A/V cable by following the color codes on the jacks and plugs.

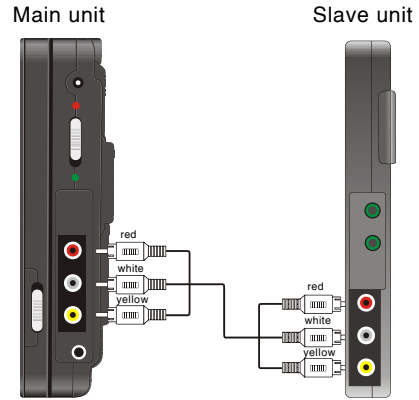

2. Connecting the DVD player to your TV

This DVD player can also be used to view movies on your large screen TV. For viewing movies on your TV, just main unit is needed, and you may turn DISPLAY ON/OFF switch on the main unit to off position to shut off the TFT LCD display.

Ensure that you observe the color coding when connecting audio and video cable.

Using the attached A/V cables

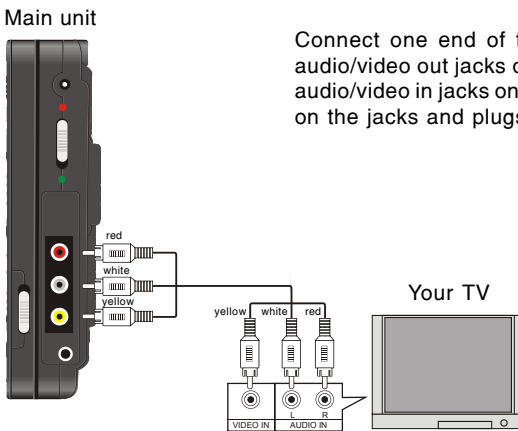

Connect one end of the audio/video cable plugs to the audio/video out jacks on the main unit and other end to the audio/video in jacks on your TV by following the color codes on the jacks and plugs.





SYSTEM CONNECTIONS

Connecting to a digital home theater system

Refer to your home theater system's manual before connection.

For Video, insert the video plugs into the video out jack on the DVD player main unit and the video in jack on your TV.

For audio, connect the main unit's audio out jacks and your home theater's audio in jacks by an audio cable.

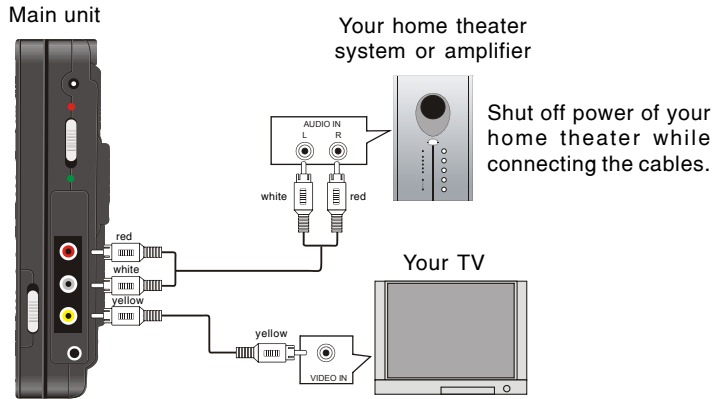

3. Connecting to your headphones (headphones are not included)

Turn down the volume of the DVD player (main unit or slave unit, depend on which unit you are using) and connect the headphones (optional, not included) to the DVD player's PHONES jack, when headphones are connected, the speakers of your DVD player will automatically turn off. Adjust the volume to your taste (but not too loud, loud sounds may damage your hearing).

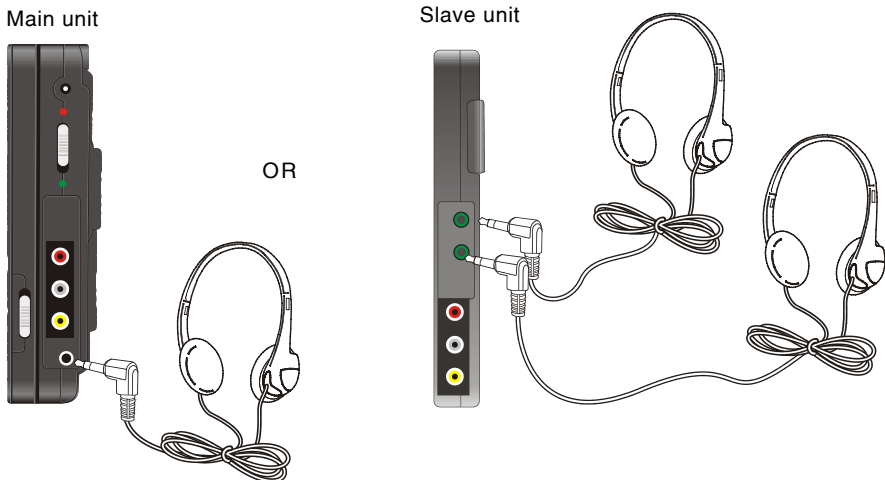

One headphones may be plugged into the main unit, and two headphones may be plugged into the slave unit.



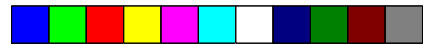

INSTALLING THE DVD PLAYER IN YOUR CAR

You can install the DVD player on your car's headrest back by using the supplied mounting straps.

1. Install the mounting straps on the DVD player.

Main unit

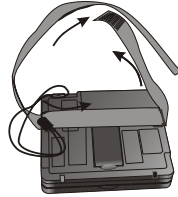

Slave unit



2. Mount the DVD player to your car's headrest.

Main unit

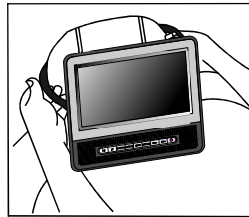

Loop the mounting strap around the headrest, adjust the length of the mounting strap to wrap the headrest tightly.

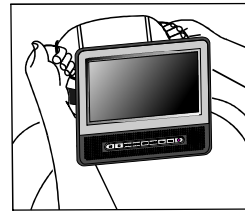

Loop the safety cord around the headrest, the safety cord will support the set in case the mounting strap opens up accidentally.

Slave unit

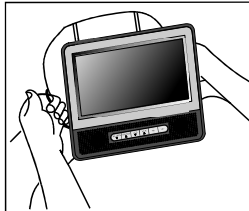

Loop the safety cord around the headrest, the safety cord will support the set in case the mounting strap opens up accidentally.

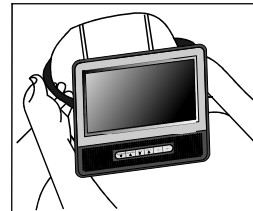

Loop the mounting strap around the headrest, adjust the length of the mounting strap to wrap the headrest tightly.

3. The two units are mounted on the car headrest, make sure the two units are installed securely, then you can connect the cables on the DVD player (refer to next page).

SAFETY WARNING!

1. This unit should never be used by the vehicle's driver or left unsecured in the vehicle while driving.
2. If this unit is being used in your vehicle, be sure that it is secured, and doesn't obstruct any safety device such as airbag or seat belts.
3. All passenger should wear seat belts when using this unit in a moving vehicle.







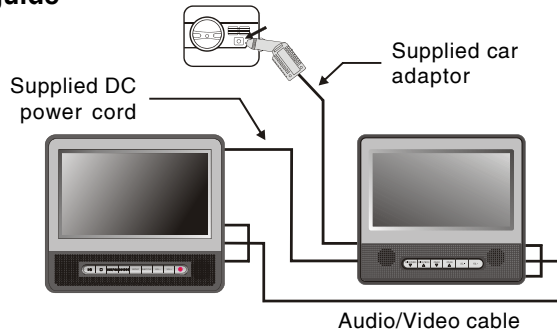

INSTALLING THE DVD PLAYER IN YOUR CAR

Cables connection guide



NOTES ON DISCS

Discs that can be played

DISC TYPE & LOGO MARK	RECORDED CONTENT
DVD Video (Region 1)  	Video + Audio
DVD-R / DVD-RW  	Video + Audio
JPEG disc “.JPG” or “.JPEG”	Video only (Photos) or Audio / Video
Music CD 	Audio only
CD-R / CD-RW disc  	Audio only or Audio / Video
MP3 disc MP-3	Audio only

NOTE: A symbol “⊗” may appear on the screen when pressing some buttons. A “⊗” means that the operation is not permitted by the DVD player for the disc in that mode or at that time. Sometimes, the set needs to be in stop mode or other modes for that button to work.

Discs that cannot be played

CD-Is, CD-ROMs (including computer software discs and game discs), data part of CD-Extras, DVD-ROMs, DVD Audio discs, DIVX, MPEG 4 DVD discs, HD layer on SACDs or discs recorded in another format such as SECAM, and regions other than your region. This set will also not play damaged, scratched or dirty discs.



1. PLAYING A DISC

- 1 Open the main unit by separating the top and bottom cabinets at the open mark (refer to diagram 1).
- 2 Place a disc gently on the tray with the label side up, make sure the disc is seated on the spindle by pressing down in the center (refer to diagram 2), then close the door (refer to diagram 3).



Diagram 1

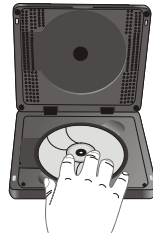

Diagram 2



Diagram 3

- 3 Slide the DVD player main unit's POWER switch to the ON position, the DVD player starts to read the disc's table of contents (this may take a few seconds). the DVD logo (start-up picture) will appear on the screen.

NOTE 1: Load the disc with the label side facing up, when playing a double-sided disc, load it with the desired playing side face down.

NOTE 2: "NO DISC" will show in the display if the disc is upside down or the disc is badly scratched or dirty, it will not play. Please clean it or change the disc before use. Also you can buy a disc polisher to try to repair the scratched disc.

- 4 Some discs will start playing automatically, and others will display the disc contents menu on the screen. If the menu is shown, use the (◀, ▶, ▲ & ▼) direction buttons on the remote to highlight your selection and press the OK button to confirm, otherwise you may press play.
- 5 Press the VOLUME + or VOLUME – button to adjust the volume level.
- 6 Press the SCREEN ON/OFF button on the remote control, then press the left ◀ and right ▶ direction buttons to adjust the brightness and the color of the LCD screen if needed. You can also press the BRIGHTNESS and COLOR buttons on the slave unit to adjust the slave unit's LCD screen.
- 7 To stop playback, press the STOP button ■.
- 8 To pause the playback, press the OK button ▶|| on the remote control or the PLAY/PAUSE button ▶|| on the main unit. To resume playback, press the OK button ▶|| on the remote control or the PLAY/PAUSE button ▶|| on the player again.
NOTE 1: During play, pressing the STOP button once will show "PRE - STOP [■]" in the display, if you press the STOP button the second time, the display will show "[■]", and now your system is in the full STOP mode.
NOTE 2: Leaving the set in the stop mode for a longer time will drain the battery the same as during normal play, remember to shut off the power after use.
- 9 To skip to another track/chapter, press the SKIP/SEARCH ▶▶ or SKIP/SEARCH ◀◀ button repeatedly during playback.
- 10 To access the disc menu or title menu during DVD play, press the MENU or TITLE button on the remote control.
- 11 Remember to shut off the player by sliding both the main unit and the slave unit's POWER switches to the OFF position when the movie finishes playing.





1. PLAYING A DISC

NOTES ON PLAYING A DISC

1. If you want to keep the main unit working and turn off the slave unit, just turn the slave unit's POWER ON/OFF switch to the OFF position. If you want to turn off the main unit and without interrupting the slave unit, just turn the DISPLAY ON/OFF switch on the main unit to OFF position and reduce the volume to lowest point.
2. The slave unit is just a second screen and speakers. Except for adjusting the color, brightness and the volume, any other special function on the disc can only be operated or adjusted on the main unit (not the slave unit).
3. This player has a screen saver which will display a bouncing DVD logo if no video is played for a while, press any button on the remote or on the main unit, the screen saver will disappear.

2. USING THE SEARCH FUNCTION

During play, you can search quickly through a chapter or track.

Search through a chapter or a track

- 1 During play, press and hold the SKIP/SEARCH button / to search forward at a faster speed, the fast search speed changes as follows:

2X → 4X → 8X → 16X →

- 2 During play, press and hold the SKIP/SEARCH button / to search backward at a faster speed, the search speed changes as follows:

2X → 4X → 8X → 16X →

NOTE: In any fast forward or fast backward mode, press the OK button on the remote control or press the PLAY/PAUSE button on the main unit to return to normal play mode immediately.

3. SELECTING AUDIO MODE

If a DVD disc contains a Multi-Audio soundtrack feature, you can select the desired audio language by pressing the AUDIO button on the remote control repeatedly during play, playback status will be displayed on the screen. The AUDIO button can also select director's cuts dialogue and other disc dialogue.

NOTE 1: If you press the AUDIO button for several times, but the desired language is not selected, it means a second language is not available on the disc.

NOTE 2: This DVD player does not support DTS decoding. For discs with DTS decoding, please press the AUDIO button to select another audio output mode, such as AC-3 or until you hear the sound.

4. CHANGING SUBTITLE LANGUAGE (DVD ONLY)

You can select a desired subtitle quickly and easily with the SUBTITLE button on the main unit or on the remote control.

NOTE: This operation works only with DVD discs on which multiple subtitle languages are recorded. Some DVDs have no subtitles, some may have 5 or more. If no subtitles are recorded on your DVD, pressing this button will not change the subtitles.

To remove the subtitles display, press the SUBTITLE button again until "SUBTITLE OFF" shows.

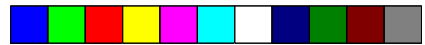

5. DISPLAYING DISC INFORMATION

If you want to know the information of the disc during play, press the DISPLAY button on the remote control, the information will appear on the LCD screen.

Each time you press the DISPLAY button repeatedly, the display information changes as follows:

For DVD

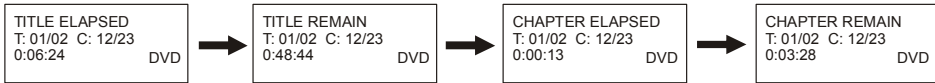

NOTE: "T" stands for title, "C" stands for chapter.

For CD

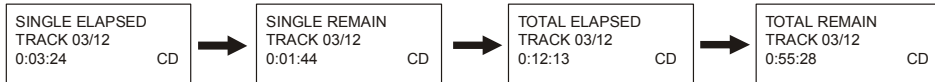

NOTE 1: Depending on the disc, the above information may not appear or you may not be able to change the display.

NOTE 2: During MP3 playback, a symbol "⊘" will show on the screen if the DISPLAY button is pressed.

6. REPEAT PLAY

The REPEAT button allows you to repeat the current track, chapter, title, a chosen section (A-B), or all of the disc. Each time you press the REPEAT button on the remote control repeatedly, the repeat mode changes as follows:

For DVD

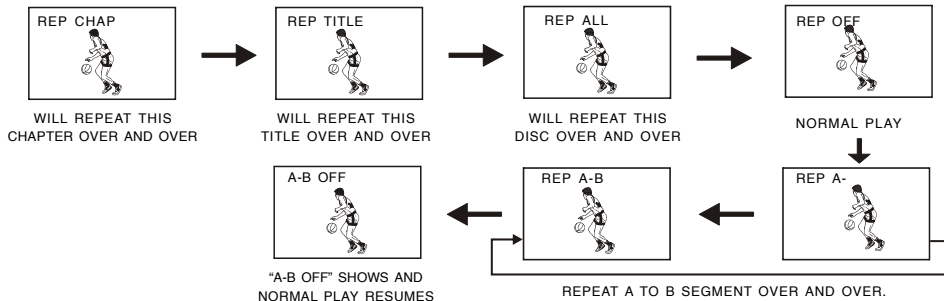

NOTE: When you select "A TO B" repeat play:

1. Press the REPEAT button until "REP A-" appears at the beginning of the segment (point A) you want to play repeatedly.
2. Press REPEAT button again at the end of the segment (point B), "REP A-B" will appear on the display.
3. The DVD player will automatically play the selected segments A to B over and over till you press REPEAT button again.

For CD

REP 1 → REP ALL → REP OFF → REP A - → REP A-B → A-B OFF

For MP3

In FOLDER mode: REP 1 → REP DIR; In FILELIST mode: REP 1 → REP ALL





7. SEARCH FOR PREFERRED PLAY

To select a scene with the title, the chapter, the track, the folder or the time during play use the GOTO button.

When playing a DVD disc

- 1 Press the GOTO button repeatedly during play, the screen will show as below:

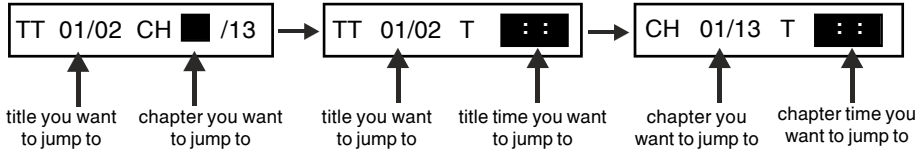

- 2 Move the left and right direction buttons (◀ & ▶) or press the numeric buttons on the remote control to select the title number, chapter number, the title time or the chapter time you want.
- 3 The player will jump to play the section you selected and the menu display disappears from the screen.

When playing a CD

- 1 Press the GOTO button repeatedly during play, the screen will show as below:

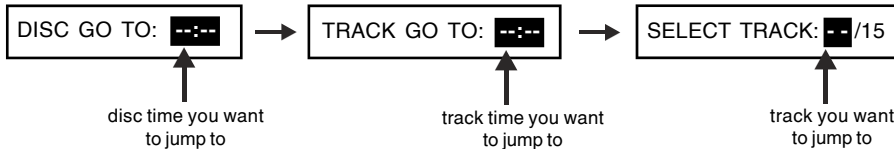

- 2 Press the numeric buttons on the remote control to input the disc time, track time or the track you want.
- 3 The player will jump to play the section you selected and the menu display disappears from the screen.

When playing an MP3 disc

- 1 Press the GOTO button during play, the screen will show as on the right:
- 2 Press the numeric buttons on the remote control to input the folder number or track number you want.
- 3 The player will jump to the section you selected.



NOTE:

During MP3 playback, there are two display modes: folder and filelist. If it is in folder mode, press the GOTO button to search for the desired folder of the disc or track in the current folder; If it is in filelist mode, press the GOTO button to search for the desired track of the disc.





8. SLOW-MOTION PLAY (JUST FOR DVD)

A disc can also be played in slow-motion by pressing the ZOOM/SLOW button.

- 1 Each time you press **and hold** the ZOOM/SLOW button on the remote during play, the playback speed will change as follows:

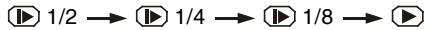

- 2 Press the OK button on the remote to resume normal play from any slow-motion mode.

NOTE: Sound will be silent during slow motion play.

9. ZOOM PLAY (FOR DVD)

The ZOOM/SLOW button allows you to do a minimal zoom into a picture as well as shift the zoom point.

- 1 Press the ZOOM/SLOW button on the remote control repeatedly to enlarge or reduce a picture. The display will show as follows:



- 2 Press the direction buttons (▲, ▼, ◀, ▶) to move the enlarged picture up, down, left or right.

- 3 To return to normal play from the ZOOM mode, press the ZOOM/SLOW button repeatedly till the ZOOM icon goes off.

NOTE 1: Some discs may not respond to the zoom feature and during some zoom functions the picture edges may seem fuzzy, this is normal.

NOTE 2: When reducing to smaller sizes, the black area around the picture will enlarge, this is normal.

10. VIEWING ANGLE SHOTS (DVD ONLY)

Some DVD video discs may contain scenes which have been shot simultaneously from a few different angles. This icon  will be on the DVD case if it contains these multi-angle shots. Certain scenes can be viewed from many different angles by pressing the PROGRAM/ANGLE button on the remote control.

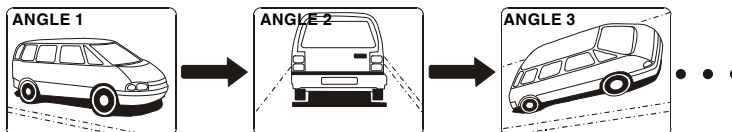

NOTE: 1. The recorded angles differ depending on the disc used.

2. Only some DVD discs have this feature (very few).

3. If this feature is not available on your DVD, a symbol "⊘" will show in the top left corner when the PROGRAM/ANGLE button is pressed.



11. MP3 DISC OPERATION

This allows you to play your MP3 recorded disc on this set. This set will not play WMA format songs. When recording your MP3 disc on your computer, please record the songs in MP3 format.

- 1 Load your recorded MP3 disc into the player, a menu will show as diagram A.
- 2 Press the ▲ or ▼ button to select the desired folder, then press the OK button to open it.
- 3 Press the ▲ or ▼ button to select the desired track in the current folder, then press the OK button to start to play the songs in the folder beginning with the selected track, the menu will show as diagram B:

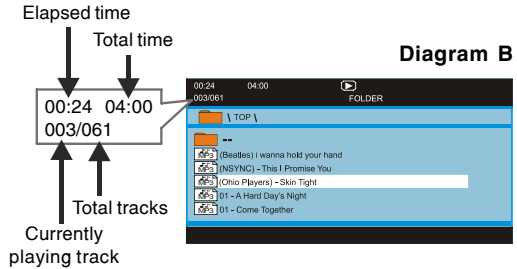
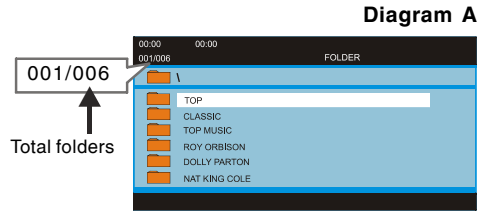

- 4 After finishing playing the folder's songs, the player will turn to STOP mode. To play other folder's song, press the ◀ button, all the folders of the disc will be displayed, and then repeat steps 2 and 3.
- 5 You may use the SKIP/SEARCH ◀◀ or ▶▶ button to skip to the previous or next track.
- 6 Press the STOP button to stop playing.

NOTE: There are two display modes: folder and filelist, you can switch them by pressing the ANGLE/PROGRAM button.

FOLDER

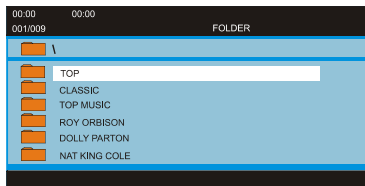

FILELIST

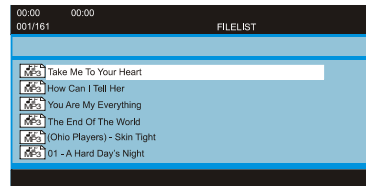

12. CD PROGRAMMED PLAY

You can make a program of up to 20 tracks in the order you want them to be played. This feature can be used on CD.

- 1 Press the ANGLE/PROGRAM button on the remote, the screen will display as below:





12. CD PROGRAMMED PLAY

Continued

- Use the number buttons and the direction buttons to enter the track numbers of the songs on the disc into the numbered positions. The positions represent the order in which you would like the songs to be played. For programming from the eleventh to twentieth track, press the SKIP/SEARCH ►► button, the screen will display as below:

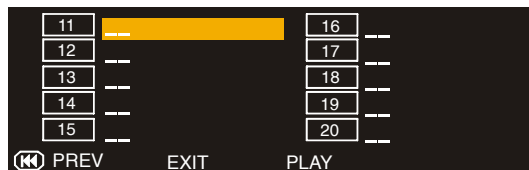

- After programming, move the direction buttons to select “PLAY” in the menu then press the OK button on the remote control, the player will start to play the disc in the programmed order.
- To skip to the next (programmed) track, press the SKIP/SEARCH ►► button.
- To stop programmed playback, press the STOP button twice.

NOTE: To clear all the information you have entered, move the direction buttons to select “CLEAR” in the menu then press the OK button on the remote control.

13. JPEG OR PICTURE DISC OPERATION

You can play your JPEG or picture disc on this set.

- Load a JPEG disc or picture CD disc into the player, a menu will show on the screen.
- Press the ▲ or ▼ button to select the desired folder, then press OK button to open it.
- Press the ▲ or ▼ button to select the desired JPEG photo in the current folder, then press OK button to start to view the JPEG photos in the folder beginning with the selected photo.
- After finishing playing the folder’s photos, the player will turn to STOP mode. To play other folder’s photo, press the ◀ button, all the folders of the disc will be displayed, and then repeat steps 2 and 3.
- To switch the display mode: folder and filelist, press the ANGLE/PROGRAM button in the STOP mode.
- During the picture show, use the (▲ / ▼ / ► / ◀) direction buttons to rotate, invert, or mirror the picture left or right.
- Press the ZOOM/SLOW button repeatedly to reduce or enlarge a picture. The display will show as follows:
 ZOOM 125% → ZOOM 150% → ZOOM 200% → ZOOM 75% → ZOOM 50%
 To move the enlarged picture in any direction, press any of the (▲ / ▼ / ► / ◀) direction buttons.
 To return to normal view, press the ZOOM/SLOW button till ZOOM icon goes off.
- Press the SKIP/SEARCH ►► button to see the next image in your folder.
- Each picture in the current directory will be displayed consecutively in a slide show presentation.



WATCHING A DVD ON YOUR TV

Please connect the DVD player main unit and your TV set by following the steps on pages 12 and 13, then follow steps below to watch a DVD on your TV.

- 1 Make sure all of the equipment is plugged back into the AC outlet.
 - 2 Open the main unit by separating the top and bottom cabinets at the open mark.
 - 3 Place a disc gently on the tray with the label side up, make sure the disc is seated on the spindle by pressing down in the center, then close the door.
 - 4 Slide the DVD main unit's POWER switch to the ON position, the DVD logo (start-up picture) will appear on the screen.
 - 5 Turn on your TV and set it to DVD mode (please see box below), the DVD logo will appear on your TV's screen.
 - 6 Some discs will start playing automatically, and others will display the disc contents menu on the screen. If the menu is presented, use the (◀, ▶, ▲ & ▼) direction buttons to highlight your selection and press OK button to confirm.
 - 7 Press the VOLUME + or VOLUME – button on the DVD's remote control and on your TV's remote control to adjust the volume level.
 - 8 Press and hold the SCREEN ON/OFF button on the remote or slide the DISPLAY ON/OFF switch on the main unit to OFF position to turn off the LCD screen, the DVD player will continue to work, but the screen will be dark, so that you only see the program on your TV set.
 - 9 To stop playback, press the STOP button.
 - 10 To pause the playback, press the OK button ▶|| on the remote control. To resume playback, press the OK button ▶|| again.
- NOTE 1:** During play, press the STOP button once, the display will show "PRE - STOP []". If you press the STOP button the second time, the display will show "[]", and now your system is in the full STOP mode.
- NOTE 2:** Leaving the set in the stop mode for a longer time will drain the battery the same as during normal play, remember to shut off the power after use.
- 11 To skip to another track/chapter, press the SKIP/SEARCH ►► or ◄◄ button repeatedly during playback.
 - 12 To access the disc menu or title menu during DVD play, press the MENU or TITLE button on the remote control.
 - 13 If you want to use other DVD play functions, please see pages 17-22.
 - 14 Remember to shut off the player by sliding the POWER switch to the OFF position when the movie finishes playing.

How to Find your TV's Video Input Channel

Make sure you have made all the connections (see page 12), you may need to change your TV's video input mode to see the DVD player's menu and movies, also double check that both TV and player are plugged into the AC outlet.

1. Set your TV to the correct video input. For example, if you connect this player to the VIDEO 1 input on your TV, switch your TV to video 1.
2. Switch your TV to the correct video input channel. The video input channel varies with different TV brands and models, many TV remote controls have a TV/VIDEO button which can be used to change to different video inputs and back to TV for normal broadcast viewing, on some older TVs, you may need to press channel 3 or 4 on your TV's remote. Once you selected the correct channel, your TV will show the opening DVD screen. For more details, please see your TV's manual.



INITIAL SETTING

When using the DVD player for the first time, you may need to set some of the settings and adjustments according to your TV and favorite preferences.

You can get to the SETUP menu by following the below steps.

- 1 Press the SETUP button on the remote control, a SETUP menu will appear on the TV screen.
- 2 Use the ▲ / ▼ / ► / ◀ direction buttons to highlight your selection.
- 3 Press the OK button to confirm your selection.
- 4 When the setup has been done, press the SETUP button to exit the SETUP mode.

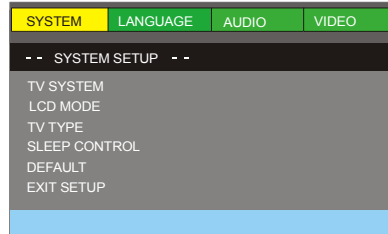

SYSTEM SETUP (TV SYSTEM, LCD MODE, SLEEP CONTROL, TV TYPE, & DEFAULT)

Setting the TV SYSTEM (only when you are using your TV to watch the picture).

- NTSC

A USA video standard. If your TV is NTSC system, select this mode.

- PAL

A video standard. If the connected TV is PAL system, select this mode.

- AUTO

If the connected TV is multi-system, select this mode. The output format will be in accordance with the video signal of the disc.

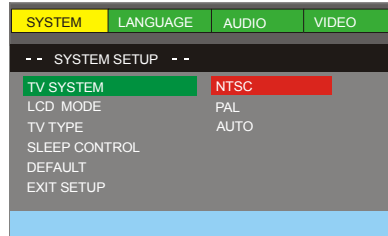

Setting the LCD MODE

This allows you to set the aspect ratio of the LCD screen.



4:3



16:9

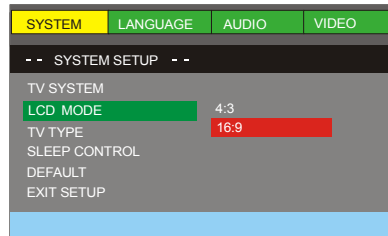

Setting the SLEEP CONTROL

This allows you to fall asleep to a movie or music disc and the DVD player will stop itself at a set time.

NOTE: When the selected sleep time is reached after play, the system will go into STANDBY mode.

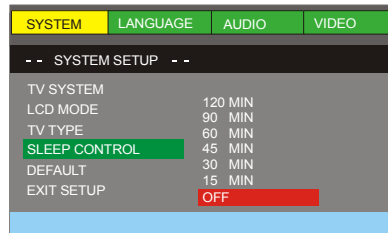



INITIAL SETTING

Selecting the TV TYPE

Select the aspect ratio of the movie to match the LCD screen and your TV set. There are three types of screen sizes you may select.

NOTE: If your DISC is not encoded to allow you to change the aspect ratio, the TV display cannot be changed.

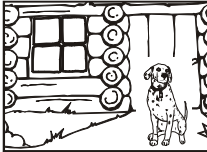
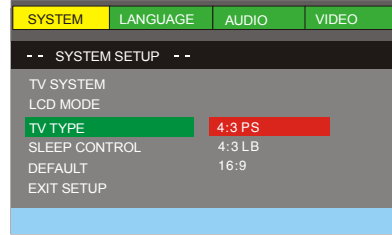

4X3 Standard

4 X 3 Standard (4:3 PS PAN and SCAN) - Choose this setting if you want to see the movie fill the entire screen of your TV. This might mean that parts of the picture (the left and right edges) won't be seen.

Most discs produced in a WIDESCREEN format can't be cropped in this fashion.



4X3 Letterbox

4 X 3 Letterbox (4:3 LB LETTER BOX) - Choose this setting if you want to see movies in their original aspect ratio (width-to-height ratio). You'll see the entire frame of the movie, but it will take up a smaller portion of the screen vertically. The movie will appear with black bars at the top and bottom of the screen, but you will see everything to the left & right of the center as in a movie theater.



16X9 Widescreen

16 X 9 Widescreen (16:9) - Choose this setting if your DVD Player is connected to a WIDESCREEN TV. If you choose this setting and you don't have a widescreen TV, the images on the screen may appear distorted due to vertical compression (faces may seem long and thin).

If you play a disc recorded in 4 X 3 format on a widescreen TV, the left and right side of the screen will appear black. Press SETUP button to change to 4:3 ratio or match the type of TV you have.

NOTE: For 16:9 Widescreen TV TYPE, you need to adjust both the LCD mode and the TV TYPE to 16:9 (see page 24 for Setting the LCD MODE).

Default - Resetting the functions to factory defaults

In case you fiddled around with your set's controls and you cannot return the set to its normal operation; you can reset the major options on this set.

NOTE: If you select "DEFAULT" and "RESTORE", then press OK, all items in the setup menu will be reset to their factory default settings.

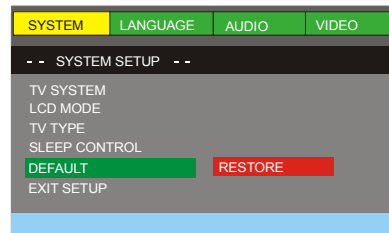



INITIAL SETTING

LANGUAGE SETUP (On Screen Display, AUDIO, SUBTITLE & MENU)

These items allow you to preset the OSD language (OSD = On Screen Display), audio language, subtitle language, and menu language that will always be used for every disc on this player (if the language selected is available).

NOTE 1: If the language selected is not available on the disc, the original language designated by each disc will be selected.

NOTE 2: You can change the AUDIO or SUBTITLE language easily by pressing the AUDIO or SUBTITLE button (refer to page 17).

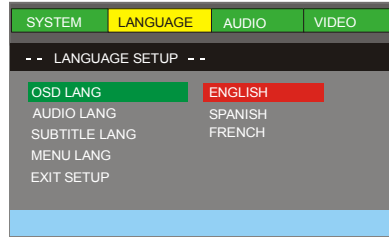

AUDIO SETUP (DOWNMIX)

Whether you use the DVD player stand alone, connect to the slave unit, or a TV or a home theater with the supplied A/V cable, you can select the audio output by entering AUDIO SETUP and setting the DOWNMIX.

- LT/RT

LT/RT stands for left and right soundtrack. Select this item when the disc supports Pro Logic Dolby Stereo. You have the opportunity to hear a program's soundtrack in the most accurate and realistic presentation possible.

- STEREO

For 5-channel output, the left and right track signals are output simultaneously. For your home theater, set the menu to stereo.

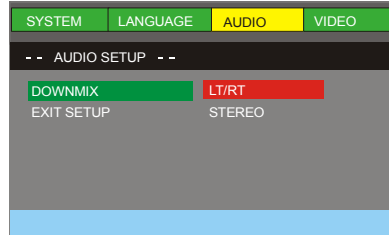

VIDEO SETUP

These settings allow you to set the video signal Brightness, Contrast, and color.

BRIGHTNESS – The brightness of the video signal (how light the picture is).

CONTRAST – The contrast of the video signal (the dark portions of pictures).

COLOR – The color of the video signal (the vividness of the color).

All above can be adjusted to your tastes.

Select the option you want to adjust using the ▲ / ▼ buttons, then press the ► button, the menu changes to the diagram on the right:

Press the ◀ / ▶ buttons to adjust the brightness, contrast, and color, press the SETUP button to confirm and exit the setup.

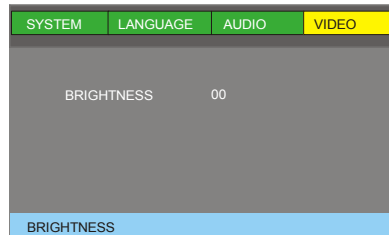
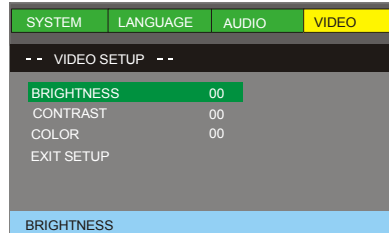



PRECAUTIONS

Safety

- As the laser beam used in the DVD player may be harmful to the eyes, do not attempt to disassemble the cabinet. Refer servicing to qualified personnel only (it is perfectly safe if you don't unscrew and open the cabinet).
- Should any solid object or liquid fall into the player, unplug the player, and have it checked by qualified personnel before operating it any further.

Placement of Your DVD Player

- Do not leave the player in a location near a heat source, or in a place subject to direct sunlight, excessive dust or mechanical shock.
- Do not place the player on an incline or unstable place, it may fall and break.
- Do not place anything within 2 inches of the sides or back of the cabinet. The ventilation holes must not be covered for the player to operate properly and to prolong the life of its components.
- Don't place this DVD player on lacquer finished furniture without a cloth, wood or glass protector in between.
- Exposure to extreme hot or cold temperatures may cause damage to the player or cause it to malfunction. Do not expose the player to direct sunlight continuously or leave it in a vehicle with the doors and windows closed. The case may become deformed or discolored or the player may malfunction.

Cleaning the Cabinet

- Clean the cabinet, panel and controls with a soft cloth slightly moistened with a very mild detergent solution or a plain damp cloth. Do not use any type of abrasive pad, scouring powder, or solvent, such as alcohol or benzine.
- Never touch the lens with your fingers, if the lens gets dirty, it will not play. Clean the disc before use.

Operation

- If moving from a cold environment to a warm environment, let the player's temperature stabilize before operation. Moisture may condense on the lens inside. Remove the disc and wait about an hour for the moisture to evaporate.
- If the player has not been used for a long time, turn the set to ON to warm it up for a few minutes before inserting a disc.

Handling Discs

- Do not touch the playback side of the disc. Every fingerprint can cause playback problems. Do not scratch the disk.
- Do not store the Discs in a place subject to direct sunlight or near heat sources.

Cleaning Discs

- Before playing, make sure the disc is clean. If not, clean the disc with a cleaning cloth. Wipe the disc in a straight motion from the center out.

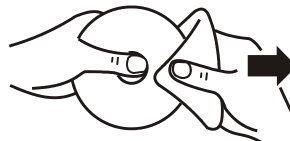

- Do not use solvents such as benzine, thinner, commercially available cleaners or anti-static spray intended for vinyl LPs.
- If the disc is scratched, it will not play. Sometimes a scratched disc can be repaired with a disc polishing machine available in many stores.



TROUBLE SHOOTING

Symptom	Remedy
No image on the main unit's LCD screen.	The main unit's LCD may be turned off. 1. Make sure the main unit's DISPLAY ON/OFF switch is at the ON position. 2. Press and hold the SCREEN ON/OFF button on the remote or turn the player off and turn it on again.
No power.	1. The POWER switch is at the OFF position, please slide it to ON. 2. The built-in battery is depleted, please recharge the battery or use the AC adaptor or car adaptor, make sure the AC outlet has power. 3. The fuse in the car adaptor is blown. To change the fuse, unscrew the tip, replace only with same 3A 250V fuse. 4. When you are using the main unit and the slave unit together, make sure the two units are connected as the steps on pages 9, 10 and 12.
No image on the slave unit's LCD screen.	1. Make sure the two units are connected correctly. 2. Make sure the POWER switch is at the ON position of both sets.
Slave unit cannot be adjusted.	Only the main unit can be adjusted, the slave unit is just a second screen with speakers.
Battery drains too fast in stop mode.	The set continues to be on even in stop mode. If you plan on leaving the disc stopped for a longer time, turn the set's power off to conserve battery power or use the AC adaptor.
General • Play fails to start even when PLAY is pressed. • Play starts but then stops immediately.	1. Make sure all power cables are connected properly. 2. The disc may be damaged or scratched. 3. This player cannot play a DVD disc other than region 1 standard. 4. The disc may be dirty and may require cleaning. 5. Ensure that the disc is installed with the label side up (facing you). 6. If your disc is rented, it may be scratched or damaged from a previous renter. Return it or polish it. 7. Condensation may have formed on your disc. Wait about 1 hour to allow the player to dry out.
No picture on your external TV's screen.	1. Ensure that the equipment is connected properly. Double check all cables and AC power. 2. Select the proper video channel on your TV set, VIDEO 1, 2, 3, etc. 3. Check if the proper AV input is selected on your TV set video inputs (some TV sets have 3 or 4 different inputs). 4. Make sure both the TV and DVD player are on.
The picture is distorted.	1. Picture is distorted during rapid advance or rapid reverse. The picture may be somewhat distorted occasionally, this is normal. 2. Did you connect your DVD player to your VCR? Please connect the player directly to your TV and disconnect the VCR. This player has Macrovision copy protection, this will distort pictures when used with VCRs.
Some lines appear on the screen during the startup of the vehicle.	Please turn the unit off and turn it on again after the vehicle is running.



TROUBLE SHOOTING

Symptom	Remedy
The picture seems squeezed or stretched.	The LCD mode and TV type you are in may be wrong for this movie, try changing the LCD and TV type setting for standard or widescreen. See pages 24 & 25.
No sound from your TV or speakers.	<ol style="list-style-type: none"> 1. Press AUDIO button several times. The disc may have been set to DTS output or a blank audio channel on multiple language, please select AC-3 output or reset to the main language (refer to page 17). 2. Adjust the DVD player's volume. 3. Make sure the AUDIO output connection and setting are correct. See details on pages 12,13 and 26. 4. Ensure that the equipment is connected properly. 5. Ensure that the input setting for the TV and stereo system are correct. 6. Adjust the volume setting on your TV's remote. 7. Make sure the headphones are detached from the DVD player. 8. The movie is paused, press play. 9. The movie is in search or fast play or other speed related play. Audio is heard only during normal play.
There is no function or less function when you adjust the color or the brightness of the LCD screen.	The disc you used is a poorly copied one, please replace it with a fresh original disc.
The remote control unit does not work.	<ol style="list-style-type: none"> 1. Check that the remote's batteries are installed correctly. 2. The remote's batteries are weak or depleted, replace it with new ones (refer to page 11). 3. Use the remote control at a distance of less than 20 feet (6m) from the DVD player main unit. 4. Remove any obstacles between the remote control and remote control sensor, also make sure the lens on the remote control is not dirty. 5. Make sure you point the remote to the DVD player main unit, not the slave unit or TV.
No rapid advance or rapid reverse play.	Some discs may have sections which prohibit rapid advance (or rapid reverse), or even pause, especially on opening screens or during FBI warnings, etc..
Cabinet vibrates or hums.	This is normal for high speed reading of DVD discs.
The player's controls don't work or the player cannot work properly.	<p>Set needs to be reset.</p> <p>Reset the DVD player by sliding the main unit's POWER switch to the OFF position and disconnecting the AC adaptor for 1 minute. Replace the AC adaptor and slide the main unit's POWER switch to ON position to resume normal use. (The player may not be operating properly due to lightning, static electricity, damaged or wrong discs, or some other external factors).</p>

General



TROUBLE SHOOTING

Symptom	Remedy	
General	A specific disc does not play.	<ol style="list-style-type: none"> 1. The disc may be dirty, try cleaning the disc. 2. Make sure the disc is not upside down. 3. The region code is not 1, the disc cannot be used. 4. Disc may not be industry standard or it may be an illegal copy. Only use legally sold movies not pirated copies.
	No sound during fast forward or other speed functions.	This is normal. Normal sound only happens during normal play.
	Cannot change a menu item.	Try changing this item with the DVD door open (not during play).
DVD	The LCD picture is not 16:9 widescreen even you have set the TV TYPE to 16:9.	You need to adjust both the LCD mode and the TV type mode to 16:9 (see pages 24 and 25).
	Audio soundtrack and/ or subtitle language is not at the initial settings.	If the audio soundtrack and / or subtitle language does not exist on the disc, the language selected at the initial setting will not be heard/seen. Try setting it up again, see Page 26.
	No subtitles.	Subtitles appear only on discs which contain them. If subtitles don't show, press the SUBTITLE button to display the subtitles.
	Alternative audio soundtrack (or subtitle) language does not show.	Some discs only have one language available. On some discs, the alternate language cannot be selected by operating the AUDIO or SUBTITLE buttons, try selecting it from the DVD menu if one is available.
	Angle cannot be changed.	This function relies on the DVD disc. Only scenes recorded at several angles can be viewed. Please refer to your DVD cover.
	Picture is frozen.	If a button is pressed too fast over and over, the signals may jam the circuits inside. To restore to normal, press the STOP button and unplug the set from the AC outlet.
	Screen saver appears on TV screen.	Turn off screen saver by pressing any button on the remote control or on the main unit.
	Cannot copy discs to VHS video tapes.	You can't copy most commercial movie discs due to copyright protection built into the disc and player.
	Display shows numbers on top of screen.	Press the DISPLAY button several times until the numbers display disappears.
	Foreign language is heard on the disc.	Press the AUDIO button until your preferred language is heard.
Foreign language is seen in menus.	Reset the default language to your preferred language by pressing the SUBTITLE button.	

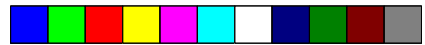

GLOSSARY

TITLE

The longest sections of a picture or a music piece on a DVD, or a movie, etc.. Each title is assigned a title number enabling you to locate the title you want.

CHAPTER

Sections of a picture or a music piece on a DVD that are smaller than titles. A title is composed of several chapters. Each chapter is assigned a chapter number enabling you to locate the chapter you want.

JPEG

JPEG is short for the "Joint Photographic Experts Group", a group of experts nominated to produce standards for continuous tone image coding. In other words, your DVD player can view digital picture CDs or CDs you made on your computer with file names that end in the ".JPG" format. This set will not play pictures encoded in formats other than JPG.

VIDEO INPUT

This is a jack which accepts the picture portion of a signal. In order to use this DVD player, your TV set must have a video input (standard) jack.

VIDEO CABLE

This is a wire with plugs on each end which is used to transfer the picture information into your TV set.

NTSC

National TV Systems Committee for TV broadcasts: a video standard used in the USA and Canada.

PAL

Phase Alternation Line: a video standard used in Europe.

JACK

This is another term for socket.

ABOUT DVD REGION MANAGEMENT

The DVD inventors and motion picture makers have decided to break up the world's DVDs into regions so that one country's DVDs should not be able to play in another country.



This is a legal issue and that is why your DVD player is restricted to play only region 1 DVDs.



SPECIFICATIONS

General Description

TFT LCD screen size:	Main unit 7" Slave unit 7"										
Power source:	AC adaptor: 100 - 240V, 50/60Hz, DC 9V, 2A output (included) Car adaptor: 12V input, 12V, 2A output (included), fuse 3A, 250V										
Power consumption:	18 Watts [normal household current]										
Signal system:	NTSC, PAL, multi-system										
Video output level:	1.0 Vp-p										
Audio output level:	1 Vrms (1 kHz, 0dB)										
Dimensions (Approx.):	<table> <tr> <td>Main unit</td> <td>Slave unit</td> </tr> <tr> <td>Length: 189 mm 7 7/16"</td> <td>Length: 189 mm 7 7/16"</td> </tr> <tr> <td>Width: 167 mm 6 9/16"</td> <td>Width: 167 mm 6 9/16"</td> </tr> <tr> <td>Height: 44 mm 1 3/4"</td> <td>Height: 22 mm 7/8"</td> </tr> <tr> <td>Weight: 0.8 kg 1.8 lbs</td> <td>Weight: 0.4 kg 0.9 lbs</td> </tr> </table>	Main unit	Slave unit	Length: 189 mm 7 7/16"	Length: 189 mm 7 7/16"	Width: 167 mm 6 9/16"	Width: 167 mm 6 9/16"	Height: 44 mm 1 3/4"	Height: 22 mm 7/8"	Weight: 0.8 kg 1.8 lbs	Weight: 0.4 kg 0.9 lbs
Main unit	Slave unit										
Length: 189 mm 7 7/16"	Length: 189 mm 7 7/16"										
Width: 167 mm 6 9/16"	Width: 167 mm 6 9/16"										
Height: 44 mm 1 3/4"	Height: 22 mm 7/8"										
Weight: 0.8 kg 1.8 lbs	Weight: 0.4 kg 0.9 lbs										

Audio Signal Output Characteristics:

DVD (linear audio):

- (1) Frequency response:
4Hz-22kHz (48 kHz sampling)
4Hz-44kHz (96 kHz sampling)
- (2) S/N ratio: 100dB
- (3) Dynamic range: 90 dB
- (4) Wow and flutter: below measurable level

CD audio:

- (1) Frequency response: 20 Hz - 20 kHz
- (2) S/N ratio: 65dB
- (3) Dynamic range: 90 dB
- (4) Wow and flutter: below measurable level

Pickup: Wave length: 650nm~660nm
Laser power: Class 1

We reserve the right to make design and specification changes for product improvement. The descriptions and characteristics given in this document are given as a general indication and not as a guarantee. In order to provide the highest quality product possible, we reserve the right to make any improvement or modification without prior notice. The English version serves as the final reference on all product and operation details should any discrepancies arise in other languages.

PROTECT YOUR FINE FURNITURE!

WE RECOMMEND A PROTECTIVE MATERIAL BE PLACED UNDER THE SET WHEN PLACING IT ON SURFACE WITH A NATURAL OR LACQUER FINISH.



LIMITED WARRANTY

We warrant this product to be free from defects in material and workmanship under normal use for a period of 90 days after purchase and we will repair it free of charge or replace it at no charge, should it become defective under this warranty, providing you submit proof of purchase (sales slip) with the set.

During the initial 90 day period after original purchase, we will service or exchange, at no charge, the set that is returned to LENOXX ELECTRONICS CORP. After the initial 90 day period expires, and for a period of 12 months from original purchase, we will repair the unit covering any part(s) that need to be replaced at no charge, but will charge for the cost of labor, return postage paid by Lenoxx.

This warranty does not apply to any products which have been subject to misuse, neglect or accident. This warranty does not cover broken cord or cabinet. UNDER NO CIRCUMSTANCES WILL LENOXX ELECTRONICS CORP. BE LIABLE FOR ANY INCIDENTAL OR CONSEQUENTIAL DAMAGES. Some states do not allow the exclusion or limitation of incidental or consequential damages, so the above limitations or exclusions may not apply to you.

This warranty gives you specific legal rights, and you may also have other rights which vary from state to state. The following charges apply to repairs beyond the warranty period: \$30.00. Be sure to pack carefully and return postage paid insured together with your money order (personal checks will not be accepted) and sales receipt to:
LENOXX ELECTRONICS CORP., 35 BRUNSWICK AVENUE, EDISON, N.J. 08817, USA

For Customer Service

Dial: 1-800-315-5885

(MONDAY - THURSDAY 8:00 AM - 5:00 PM, FRIDAY 8:00 AM - 1:30 PM EST)

or Visit Our Website: <http://www.lenoxx.com>

or Email: evergo@att.net

© 2007 LENOXX ELECTRONICS CORP.

35 BRUNSWICK AVENUE

EDISON, N.J. 08817, USA

MADE & PRINTED IN CHINA

Free Manuals Download Website

<http://myh66.com>

<http://usermanuals.us>

<http://www.somanuals.com>

<http://www.4manuals.cc>

<http://www.manual-lib.com>

<http://www.404manual.com>

<http://www.luxmanual.com>

<http://aubethermostatmanual.com>

Golf course search by state

<http://golfingnear.com>

Email search by domain

<http://emailbydomain.com>

Auto manuals search

<http://auto.somanuals.com>

TV manuals search

<http://tv.somanuals.com>