

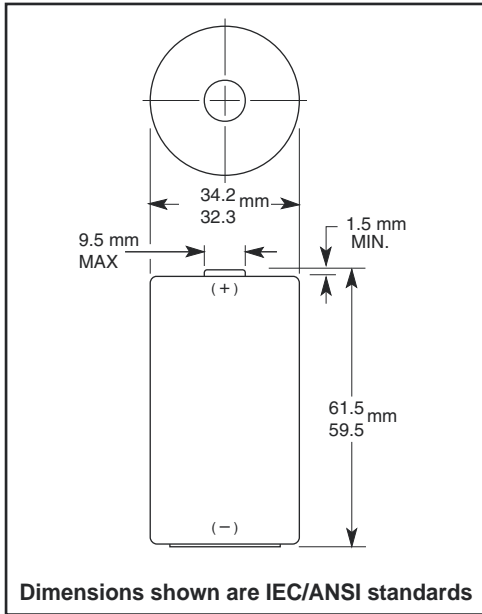

<b>Nominal Voltage:</b>	1.5 V
<b>Operating Voltage</b>	1.6 - 0.75V
<b>Impedance:</b>	136 m-ohm @ 1kHz
<b>Typical Weight:</b>	139 gm (4.9 oz.)
<b>Typical Volume:</b>	56.4 cm <sup>3</sup> (3.4 in. <sup>3</sup> )
<b>Terminals:</b>	Flat
<b>Storage Temperature Range:</b>	-20°C to 35°C
<b>Operating Temperature Range:</b>	-20°C to 54°C (-4°F to 130°F)
<b>ANSI:</b>	13A
<b>IEC:</b>	LR20

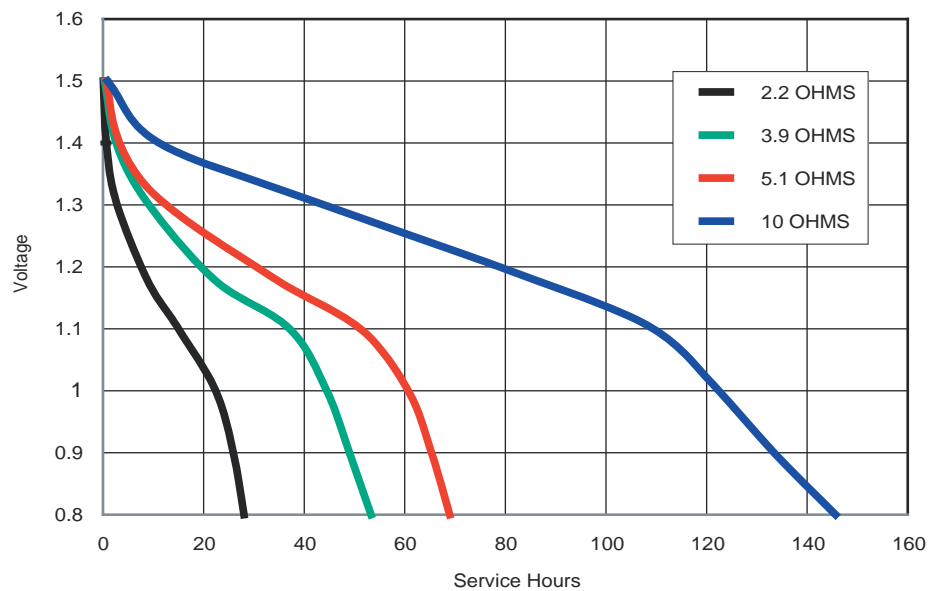

TYPICAL DISCHARGE CHARACTERISTICS AT 21°C (70°F)



**DURACELL®**  
BATTERIES

Berkshire Corporate Park  
Bethel, CT 06801 U.S.A.  
Telephone: Toll-free 1-800-544-5454  
Internet: [www.duracell.com](http://www.duracell.com)

\* Delivered capacity is dependent on the applied load, operating temperature and cut-off voltage. Please refer to the charts and discharge data shown for examples of the energy / service life that the battery will provide for various load conditions.

TYPICAL CONSTANT POWER DISCHARGE CHARACTERISTICS AT 21°C (70°F)

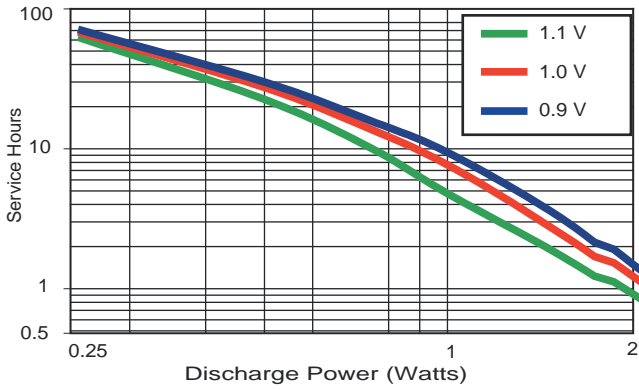

TYPICAL CONSTANT CURRENT DISCHARGE CHARACTERISTICS AT 21°C (70°F)

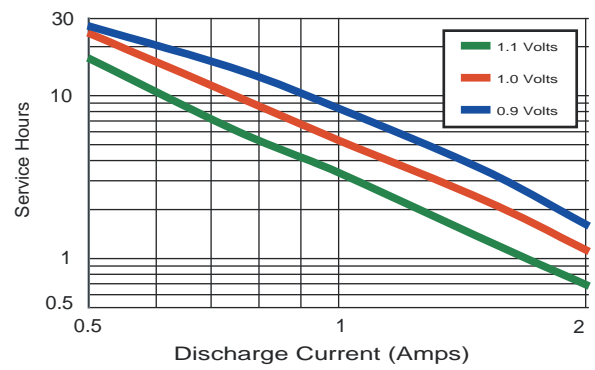

TYPICAL DISCHARGE CHARACTERISTICS AT 21°C (70°F)

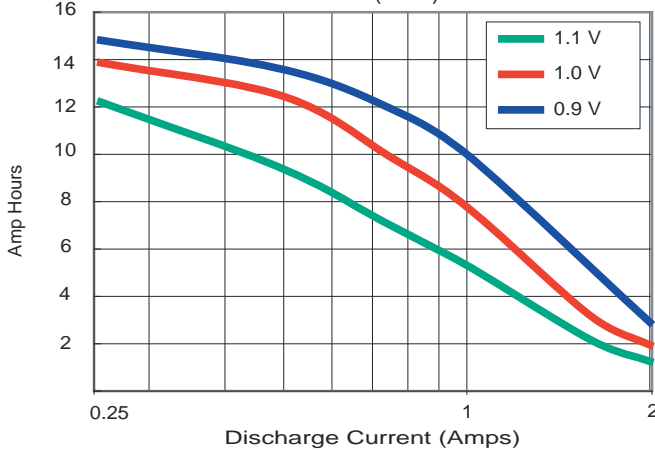

TYPICAL DISCHARGE CHARACTERISTICS AT 21°C (70°F)

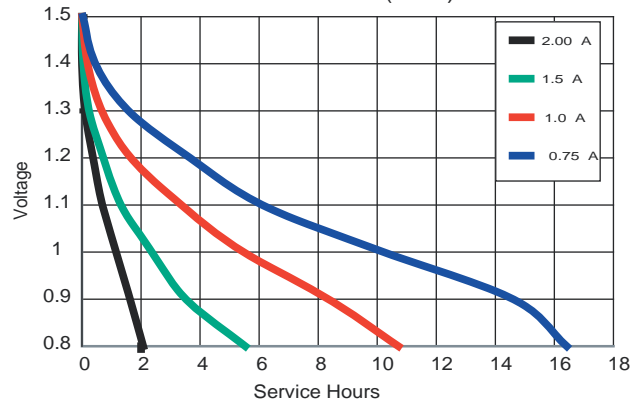

TYPICAL FLASHLIGHT TEST AT 21°C AND 0°C

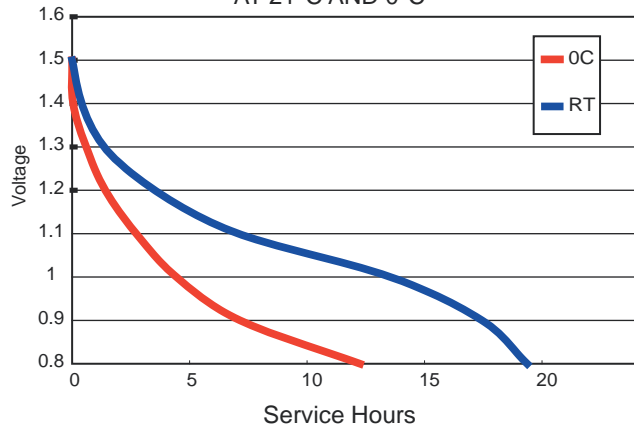

**DURACELL®**  
BATTERIES

Berkshire Corporate Park  
Bethel, CT 06801 U.S.A.  
Telephone: Toll-free 1-800-544-5454  
Internet: www.duracell.com

\* Delivered capacity is dependent on the applied load, operating temperature and cut-off voltage. Please refer to the charts and discharge data shown for examples of the energy / service life that the battery will provide for various load conditions.

## Free Manuals Download Website

<http://myh66.com>

<http://usermanuals.us>

<http://www.somanuals.com>

<http://www.4manuals.cc>

<http://www.manual-lib.com>

<http://www.404manual.com>

<http://www.luxmanual.com>

<http://aubethermostatmanual.com>

Golf course search by state

<http://golfingnear.com>

Email search by domain

<http://emailbydomain.com>

Auto manuals search

<http://auto.somanuals.com>

TV manuals search

<http://tv.somanuals.com>