

Quick Start

Make sure you have all the items shown in Figure 1. (Labels included in the package may vary.)

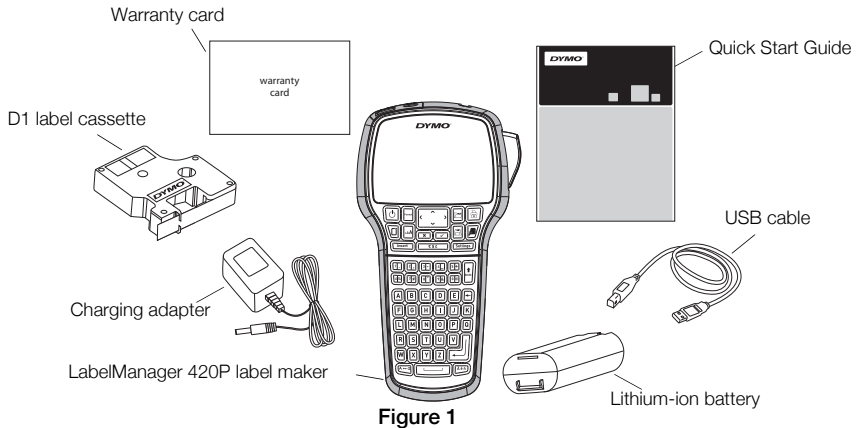

For complete information on using your label maker, download the full *LabelManager 420P User Guide* from the Support section of the DYMO Web site at www.dymo.com.

Become familiar with the features shown in Figure 2.

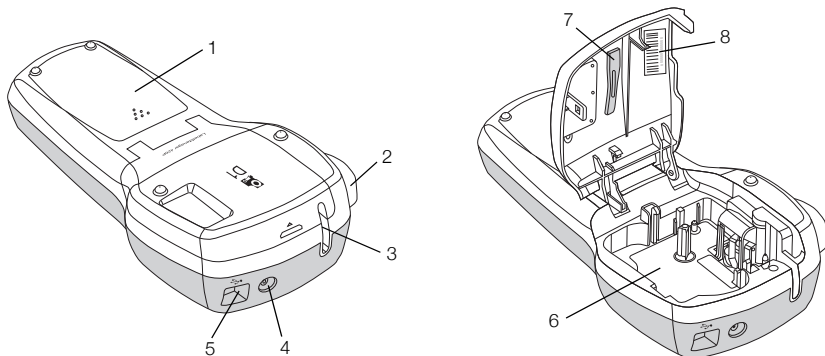

Figure 2

- | | | |
|-----------------------|---------------------|-----------------------|
| 1 Battery compartment | 4 Power connector | 7 Cleaning tool |
| 2 Cutter button | 5 USB connector | 8 Serial number label |
| 3 Label exit slot | 6 Label compartment | |

Inserting the Battery

To insert the battery

- 1 Slide the battery compartment cover away from the label maker. See Figure 3.
- 2 Insert the battery into the battery compartment.
- 3 Replace the battery compartment cover.

To charge the battery

- 1 Plug the charging adapter into the power connector on the top of the label maker.
- 2 Plug the other end of the charging adapter into a power outlet.

NOTE The charging adapter is only used for recharging the battery; the charging adapter cannot be used to power the label maker.

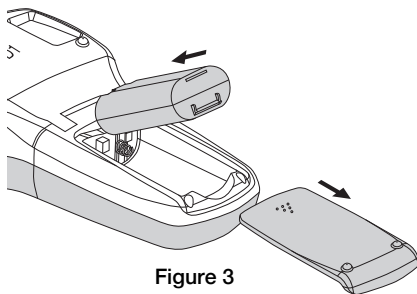

Figure 3

Inserting the Label Cassette

Your label maker uses DYMO D1 label cassettes.

To insert the label cassette

- 1 Lift the label cassette cover to open the label compartment. See Figure 4.
- 2 Make sure the tape and ribbon are taut across the mouth of the cassette and that the tape passes between the label guides. See Figure 5.
If necessary, turn the ribbon rewind spool clockwise to tighten the ribbon.
- 3 Insert the cassette and press firmly until the cassette clicks into place. See Figure 6.
- 4 Close the label cassette cover.

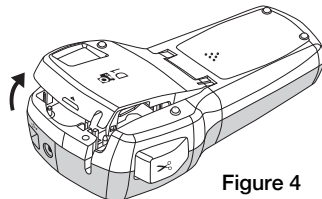

Figure 4

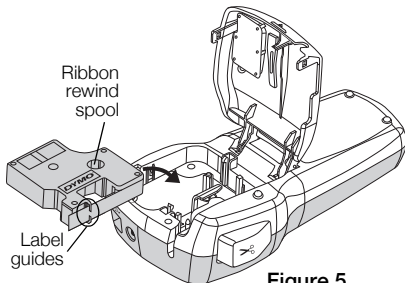





Figure 5

Printing Your First Label

The first time you turn on the power, you are asked to select the language and label width. These selections remain set until you change them.

To set up the label maker

- 1 Press  to turn on the power.
- 2 Select the language and press .
- 3 Select the width of the label cassette currently in the label maker and press .

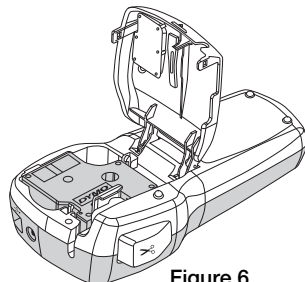



Figure 6

To print a label

- 1 Enter text to create a simple label.
- 2 Press .
- 3 Press the cutter button to cut the label.
- 4 Remove the paper backing from the label to expose the adhesive, and then attach the label.

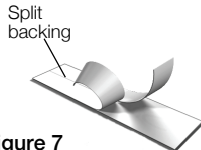

Figure 7

Using Your Label Maker with Your Computer

Connecting the Label Maker to your Computer

The label maker connects to your computer using the USB connection located on the top of the label maker. You do not need to install additional software or drivers to use the label maker with your computer.

To connect the label maker to your computer

- 1 Plug the USB cable into the USB port on the top of the label maker. See Figure 8.
- 2 Plug the other end of the USB cable into an available USB port on your computer.

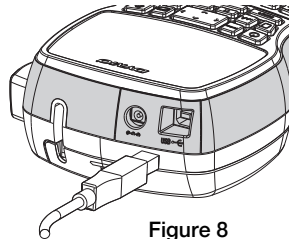





Figure 8

Starting the Built-In Software

The built-in software resides on the label maker; no installation is required.

To start the software for Windows®

- 1 If necessary, press  to turn on the label maker.
Depending on Windows AutoRun settings, the software may start automatically.
- 2 If the software does not start automatically, do one of the following:
 - If the AutoRun or AutoPlay dialog box appears, follow the on-screen instructions to start the  DYMO Label Light software.
 - If the AutoRun dialog box does not appear, navigate to **My Computer**→**DYMO 420P**, and then click  **DYMO Label Light.exe**.

To start the software for Mac OS®

- 1 If necessary, press  to turn on the label maker.
The DYMO 420P volume appears on your desktop.
- 2 Double-click **DYMO 420P** to open the volume.
- 3 Double-click  to start the software.

Disconnecting the Label Maker from Your Computer

To disconnect the label maker from your computer

- 1 (Mac Only) Drag the **DYMO 420P** volume to the trash.
- 2 Press the power button to turn off the label maker.
- 3 Unplug the USB cable from your computer.

Printing Labels with the Built-In Software

The following figure shows some of the features available in the software.

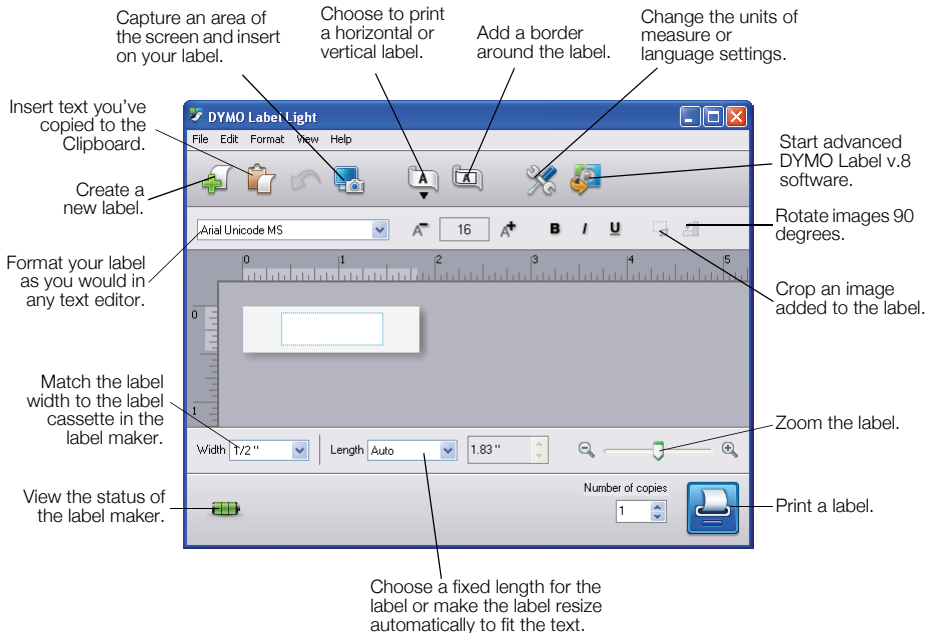

To print a first label

- 1 Click once on the label in the Edit area and type some text.
- 2 Click  to print the label.
- 3 Press the cutter button on the label maker to cut the label.

To capture and insert an image from your desktop

- 1 Click  on the toolbar.
- 2 Drag the cursor to draw a selection box around the area to capture.
The selected area is inserted into your label.

Installing the DYMO Label™ v.8 Software

To install the software on a Windows® system

- 1 Click  in the built-in software to download the latest version of DYMO Label v.8 from the Support section of the DYMO Web site.

When DYMO Label v.8 is installed, clicking  will start the software.

- 2 Close all open Microsoft Office applications.
- 3 Double-click the Installer icon.
After a few seconds, the installation screen appears.
- 4 Click **Install** and follow the instructions in the installer.

NOTE Depending on your system configuration, the software installation could take some time while the required Microsoft .NET™ software is installed.

- 5 If not already connected, connect the label maker to your computer.

QuickBooks If you have QuickBooks 2007 or later, you will be prompted to install the QuickBooks Add-in.

To install the software on a Mac OS® system

- 1 Click  in the built-in software to download the latest version of DYMO Label v.8 from the Support section of the DYMO Web site.

When DYMO Label v.8 is installed, clicking  will start the software.

- 2 Double-click the Installer icon and follow the on-screen instructions.
- 3 If not already connected, connect the label maker to your computer.

Printing Labels with DYMO Label™ v.8 Software

The following figure shows some of the major features available in DYMO Label v.8.

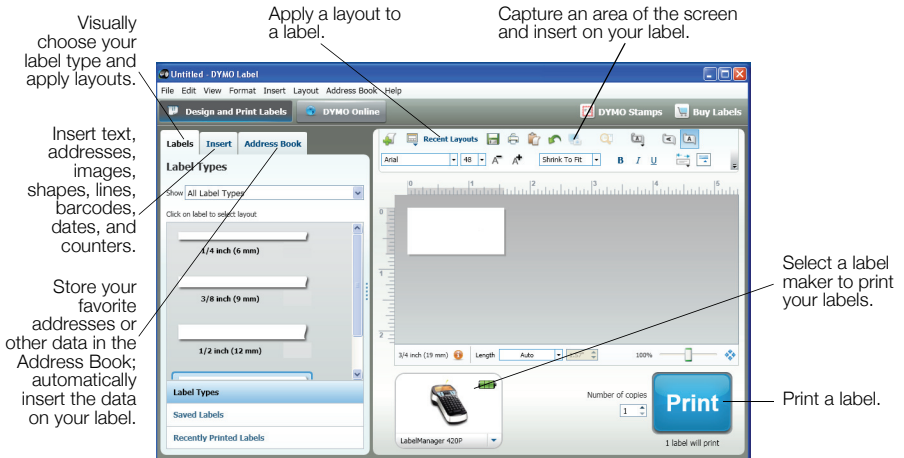

To print your first label

- 1 Click  in the built-in software to start DYMO Label v.8 software.

The first time you start DYMO Label software, a list of available label types is displayed on the left side of the window and a blank label is displayed in the Edit area.

- 2 From the **Labels** tab, select a tape label and then select a layout.

Make sure that the width of the tape label you select matches the width of the label cassette loaded in the label maker.

- 3 Click once on the tape label in the Edit area and type some text.

- 4 Click  to print the label.

For complete details on using the software, refer to the online Help.

LabelManager 420P Quick Reference

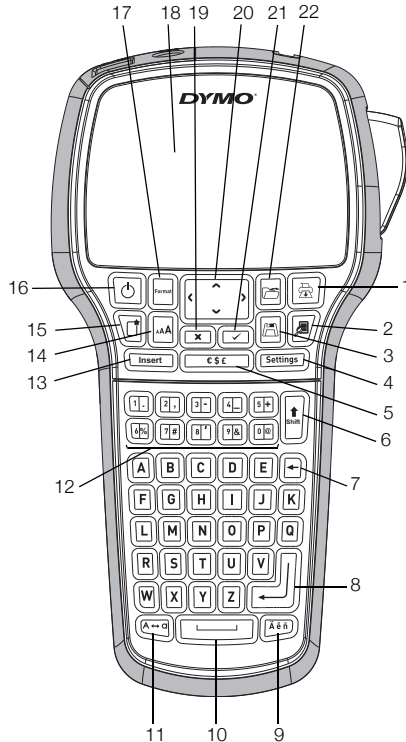
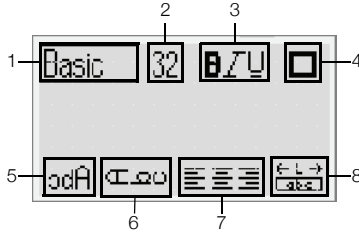

Figure 9

- | | | |
|-------------|-----------------------|----------------|
| 1 Print | 9 Accented characters | 17 Format |
| 2 Preview | 10 Space bar | 18 LCD display |
| 3 Save | 11 Caps | 19 Cancel |
| 4 Settings | 12 Numeric keys | 20 Navigation |
| 5 Symbols | 13 Insert | 21 OK |
| 6 Shift | 14 Font Size | 22 Open |
| 7 Backspace | 15 New label/Clear | |
| 8 Return | 16 On/Off | |

Formatting Quick Reference



- | | | | |
|---|------------|---|---------------|
| 1 | Font type | 5 | Mirror |
| 2 | Font size | 6 | Vertical text |
| 3 | Font style | 7 | Alignment |
| 4 | Borders | 8 | Label length |

Font Types

Basic
Serif
Fun

Fun2
Dymo
Slim

Wide
BIG

Font Sizes

Label Width
1/4" (6 mm)
3/8" (9 mm)
1/2" (12 mm)
3/4" (19 mm)

Font Size Available
8, 10, 12 point
8, 10, 12, 16, 20 point
8, 10, 12, 16, 20, 24 point
8, 10, 12, 16, 20, 24, 32, 40 point

Borders

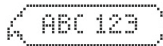
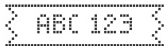
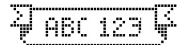
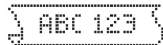
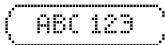
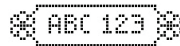
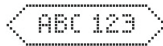
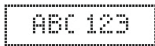

To take advantage of more advanced formatting features, click  in the built-in software to download and install DYMO Label™ v.8 software from the DYMO Web site.

Free Manuals Download Website

<http://myh66.com>

<http://usermanuals.us>

<http://www.somanuals.com>

<http://www.4manuals.cc>

<http://www.manual-lib.com>

<http://www.404manual.com>

<http://www.luxmanual.com>

<http://aubethermostatmanual.com>

Golf course search by state

<http://golfingnear.com>

Email search by domain

<http://emailbydomain.com>

Auto manuals search

<http://auto.somanuals.com>

TV manuals search

<http://tv.somanuals.com>