



DYNEX™

40" LED TV

DX-40D510NA15

USER GUIDE

Before using your new product, please read these instructions to prevent any damage.

Contents

CHILD SAFETY	1
Important Safety Instructions	2
Warning	2
Caution	3
Introduction	4
Installing the stand or wall mount bracket	4
Installing the stand	4
Installing the wall-mount bracket	6
TV components	8
Package contents	8
Front	8
Side jacks	9
Back	10
Remote control	11
What connection should I use?	12
Connecting a cable or satellite box	13
HDMI (best)	13
DVI (same as HDMI but requires an audio connection)	14
Component video (better)	15
AV (composite video) (good).....	16
Coaxial (good).....	17
Connecting an antenna or cable TV (no box)	18
Connecting a DVD or Blu-ray player	19
HDMI (best)	19
Component video (better).....	20
Composite video (good)	21
Connecting a game console	22
HDMI (best)	22
Component video (better).....	23
AV (composite video) (good).....	24
Connecting a computer	25
HDMI (best)	25
DVI (same as HDMI but requires an audio connection)	26
VGA (good)	27
Connecting a USB flash drive	28
Connecting headphones	29

Connecting external speakers or a sound bar	30
Digital audio	30
Analog audio.....	31
Connecting a home theater system with multiple devices	32
Connecting power	33
Using the remote control	34
Installing remote control batteries	34
Aiming the remote control	34
Turning on your TV for the first time	34
Understanding the basics	36
Turning your TV on or off	36
Selecting the video input source	36
Using the on-screen menus	37
Navigating the menus.....	37
Selecting a channel	38
Adjusting the volume	38
Viewing channel information	38
Using a USB flash drive	39
Switching to USB mode	39
Browsing photos	39
Viewing your favorite photos	40
Viewing photos in a slideshow	41
Customizing slideshow settings	42
Adjusting the picture	43
Adjusting the TV picture	43
Automatically adjusting the aspect ratio	44
Setting the power on picture mode	44
Adjusting the computer image	45
Adjusting the sound	45
Adjusting sound settings	45
Playing TV audio only	46
Setting parental controls	46
Setting or changing the password	46
Locking control buttons	47
Setting the system lock	48
Blocking unrated TV	48
Setting parental control levels	49
Downloading rating information	50
Adjusting time settings	51
Setting the clock	51
Setting the sleep timer	52

Using closed captioning	52
Turning closed captioning on or off	52
Selecting the analog closed captioning mode	53
Selecting the digital closed captioning mode	53
Customizing digital closed captioning styles	54
Adjusting menu settings	54
Selecting the menu language	54
Labeling an input source	55
Changing channel settings	55
Automatically scanning for channels	55
Hiding channels	56
Setting up a favorite channel list	57
Viewing a favorite channel	57
Adding or changing a channel label	57
Checking the digital signal strength	58
Maintaining	58
Cleaning your TV	58
Troubleshooting	59
Restoring settings to default	59
Viewing system information	59
Video and audio	60
Remote control	62
General	62
Specifications	64
Programming universal remote controls	65
Common universal remote control codes	65
Legal notices	66
One-year limited warranty - Dynex Televisions	67

CHILD SAFETY

PROPER TELEVISION PLACEMENT MATTERS



THE CONSUMER ELECTRONICS INDUSTRY CARES

- Manufacturers, retailers and the rest of the consumer electronics industry are committed to making home entertainment safe and enjoyable.
- As you enjoy your television, please note that all televisions - new and old- must be supported on proper stands or installed according to the manufacturer's recommendations. Televisions that are inappropriately situated on dressers, bookcases, shelves, desks, speakers, chests, carts, etc., may fall over, resulting in injury.

TUNE IN TO SAFETY

- **ALWAYS** follow the manufacturer's recommendations for the safe installation of your television.
- **ALWAYS** read and follow all instructions for proper use of your television.
- **NEVER** allow children to climb on or play on the television or the furniture on which the television is placed.
- **NEVER** place the television on furniture that can easily be used as steps, such as a chest of drawers.
- **ALWAYS** install the television where it cannot be pushed, pulled over or knocked down.
- **ALWAYS** route cords and cables connected to the television so that they cannot be tripped over, pulled or grabbed.

WALL OR CEILING MOUNT YOUR TELEVISION

- **ALWAYS** contact your retailer about professional installation if you have any doubts about your ability to safely mount your television.
- **ALWAYS** use a mount that has been recommended by the television manufacturer and has a safety certification by an independent laboratory (such as UL, CSA, ETL).
- **ALWAYS** follow all instructions supplied by the television and mount manufacturers.
- **ALWAYS** make sure that the wall or ceiling where you are mounting the television is appropriate. Some mounts are not designed to be mounted to walls and ceilings with steel studs or cinder block construction. If you are unsure, contact a professional installer.
- Televisions can be heavy. A minimum of two people is required for a wall or ceiling mount installation.

MOVING AN OLDER TELEVISION TO A NEW PLACE IN YOUR HOME

- Many new television buyers move their older CRT televisions into a secondary room after the purchase of a flat-panel television. Special care should be made in the placement of older CRT televisions.
- **ALWAYS** place your older CRT television on furniture that is sturdy and appropriate for its size and weight.
- **NEVER** place your older CRT television on a dresser where children may be tempted to use the drawers to climb.
- **ALWAYS** make sure your older CRT television does not hang over the edge of your furniture.



Important Safety Instructions



This symbol indicates that dangerous voltage constituting a risk of electric shock is present within your TV. This label is located on the back of your TV.



This symbol indicates that there are important operating and maintenance instructions in the literature accompanying your TV.

- 1 Read these instructions.
- 2 Keep these instructions.
- 3 Heed all warnings.
- 4 Follow all instructions.
- 5 Do not use this apparatus near water.
- 6 Clean only with dry cloth.
- 7 Do not block any ventilation openings. Install in accordance with the manufacturer's instructions.
- 8 Do not install near any heat sources such as radiators, heat registers, stoves, or other apparatus (including amplifiers) that produce heat.
- 9 Do not defeat the safety purpose of the polarized or grounding-type plug. A polarized plug has two blades with one wider than the other. A grounding type plug has two blades and a third grounding prong. The wide blade or the third prong are provided for your safety. If the provided plug does not fit into your outlet, consult an electrician for replacement of the obsolete outlet.
- 10 Protect the power cord from being walked on or pinched particularly at plugs, convenience receptacles, and the point where they exit from the apparatus.
- 11 Only use attachments/accessories specified by the manufacturer.
- 12 Use only with the cart, stand, tripod, bracket, or table specified by the manufacturer, or sold with the apparatus. When a cart is used, use caution when moving the cart/apparatus combination to avoid injury from tip-over.
- 13 Unplug this apparatus during lightning storms or when unused for long periods of time.



S3125A

- 14 Refer all servicing to qualified service personnel. Servicing is required when the apparatus has been damaged in any way, such as power-supply cord or plug is damaged, liquid has been spilled or objects have fallen into the apparatus, the apparatus has been exposed to rain or moisture, does not operate normally, or has been dropped.
- 15 The *wall plug* is the disconnecting device. The plug must remain readily operable.
- 16 Remote control batteries should not be exposed to excessive heat such as sunshine, fire, or the like.
- 17 The apparatus should not be exposed to dripping or splashing and no objects filled with liquids, such as vases, should be placed on the apparatus.

Warning

Electric shock hazard

To reduce the risk of fire or electric shock, do not remove any cover or expose the device to rain or moisture. No user-serviceable parts are inside. Refer servicing to qualified service technicians.

Lightning

For added protection for your device receiver during a lightning storm, or when it is left unattended and unused for long periods of time, unplug it from the power outlet and disconnect any antenna or cable system. This helps prevent property damage and personal injury from lightning and power line surges.

Power lines

An outside antenna system should not be located in the vicinity of overhead power lines or other electric light or power circuits, or where it can fall into such power lines or circuits. When installing an outside antenna system, extreme care should be taken to keep from touching such power lines or circuits as contact with them might be fatal.

Handling the LCD panel

- Your TV's screen is made of glass. Do not drop your TV or hit, jolt, or press hard against the LCD panel. If the screen breaks, be careful of broken glass.
- If the LCD panel is broken, make absolutely sure that you do not touch the liquid in the panel. This may cause skin inflammation.
- If the liquid gets in your mouth, immediately gargle, rinse, and consult with your doctor. Also, if the liquid gets in your eyes or touches your skin, consult with your doctor after rinsing for at least 15 minutes or longer in clean water.

Replacement parts

When replacement parts are required, make sure that the service technician uses replacement parts specified by the manufacturer that have the same characteristics as the original part. Unauthorized substitutions may result in fire, electric shock, personal injury, or other hazards.

Safety check

After completing any service or repair to this device, ask the service technician to perform routine safety checks to determine that your TV is in correct operating condition.

Power source

Operate your TV only from the type of power source indicated on the marking label. If you are not sure of the type of power supplied to your home, consult an electrician or your local power company.

Servicing

These servicing instructions are for use by qualified service personnel only. To reduce the risk of electric shock, do not perform any servicing other than that contained in the operating instructions unless you are qualified to do so.

Caution

Damage requiring service

Unplug this TV from the power outlet and refer servicing to qualified service personnel under the following conditions:

- When the power supply cord or plug is damaged or frayed.
- If liquid has been spilled or objects have fallen into your TV.
- If your TV has been exposed to rain or water.
- If your TV does not operate normally by following the operating instructions. Adjust only those controls that are covered by the operating instructions because incorrect adjustment of other controls may result in damage and will often require extensive work by a qualified technician to restore your TV to its normal operation.
- If your TV has been dropped or damaged in any way.
- When your TV exhibits a distinct change in performance.

Outdoor antenna grounding

If an outside antenna or cable system is connected to your TV, make sure that the antenna or cable system is grounded to provide some protection against voltage surges and built-up static charges. Article 810 of the National Electrical Code, ANSI/NFPA No. 70, provides information with respect to correct grounding of the mast and supporting structure, grounding of the lead-in wire to an antenna discharge unit, size of grounding conductors, location of the antenna-discharge unit, connection to grounding electrodes, and requirements for the grounding electrode.

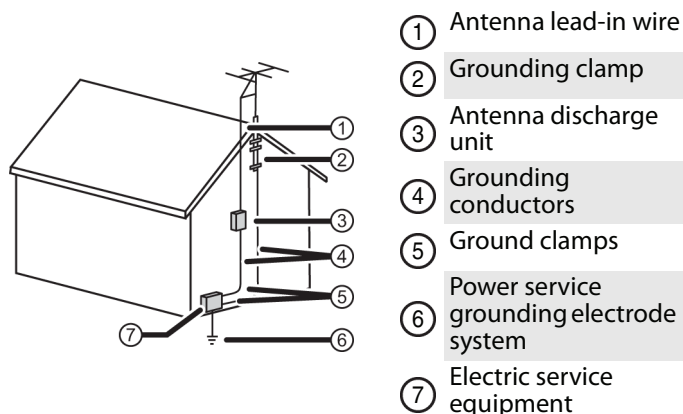

Note to CATV system installer

Article 820 of the National Electrical Code, ANSI/NFPA No. 40 provides guidance for correct grounding. Specifically, it states that the cable ground must be connected to the grounding system of the building as close to the point of cable entry as practical.

Condensation

Moisture will form on the TV if the TV is brought from cool surroundings into a warm room or if the temperature of the room rises suddenly. When this happens, the TV's performance may be impaired. To prevent this, let the TV stand in its new surroundings for about an hour before switching it on, or make sure that the room temperature rises gradually.

Condensation may also form during the summer if the TV is exposed to the breeze from an air conditioner. In such cases, change the location of the TV.

Mobile telephone warning

To avoid interference with your TV picture and sound, operating problems, or even damage, keep your cordless and cellular telephones away from the TV.

End of life directives

Your TV may contain materials that are regulated for environmental reasons. Your TV also contains materials that can be recycled and reused. To help protect the environment, contact your local authorities for information about disposal or recycling and about finding a recycler in your area before you dispose of your TV.

Non-active pixels

The LCD panel contains almost 3 million thin film transistors, which provide exceptionally sharp video quality. Occasionally, a few non-active pixels may appear on the screen as a fixed blue, green, or red point. These non-active pixels do not adversely affect the performance of your TV, and are not considered defects.

Dynex 40" LED TV

Introduction

Congratulations on your purchase of a high-quality Dynex product. Your DX-40D510NA15 represents the state of the art in LED TV design and is designed for reliable and trouble-free performance.

Installing the stand or wall mount bracket

Notes

- If you plan to wall-mount your TV, do not install the stand.
- Store the stand and stand screws in case you decide to use the stand in the future.

Installing the stand

- 1 Carefully place your TV face-down on a cushioned, clean surface to protect the screen from damages and scratches.

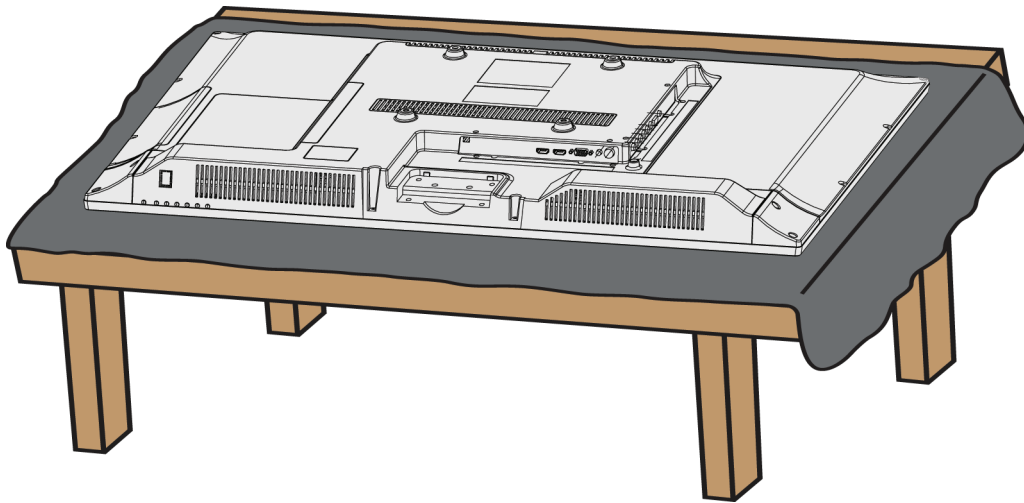

2 Secure the stand column to your TV with the four provided M4 × 14 mm screws (the longer ones).

Screw type	Screw length	# of screws
M4	14 mm	4

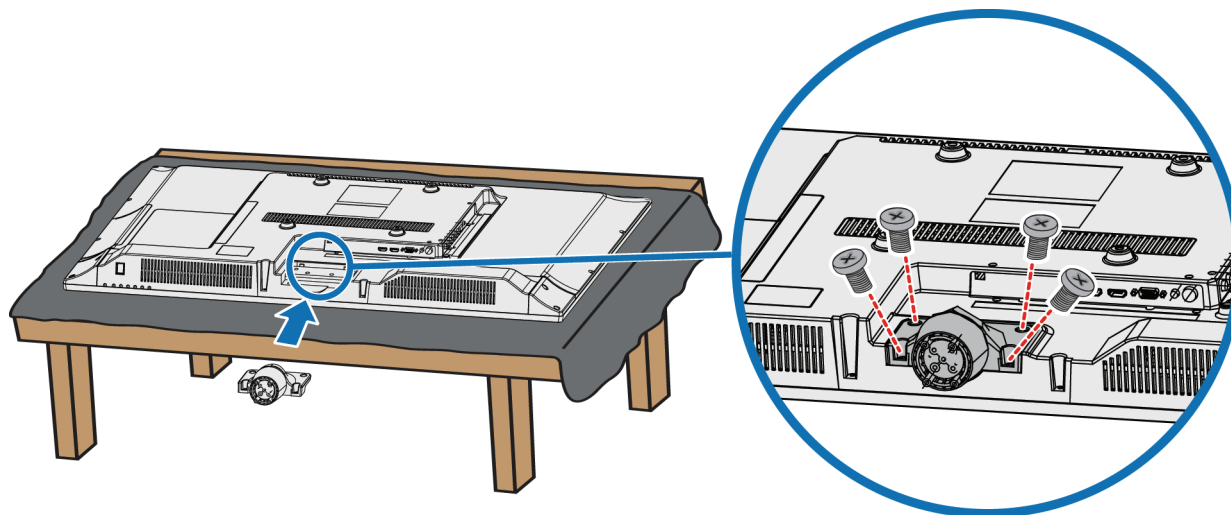

3 Find the front of the TV stand, then secure it to the stand column with the four provided ST4 × 12 mm screws (the shorter ones).

Screw type	Screw length	# of screws
ST4	12 mm	4

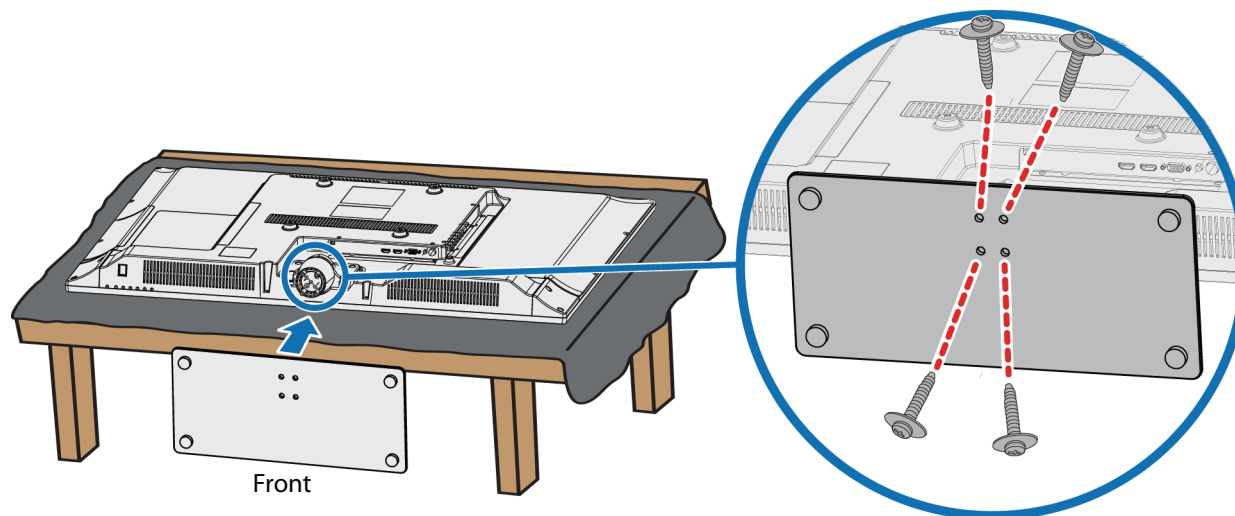

Installing the wall-mount bracket

Warning

This TV is intended to be supported by a UL Listed wall mount bracket with suitable weight/load. (See "Miscellaneous" on page 64.)

- 1 Carefully place your TV face-down on a soft surface to protect the screen from damages and scratches.

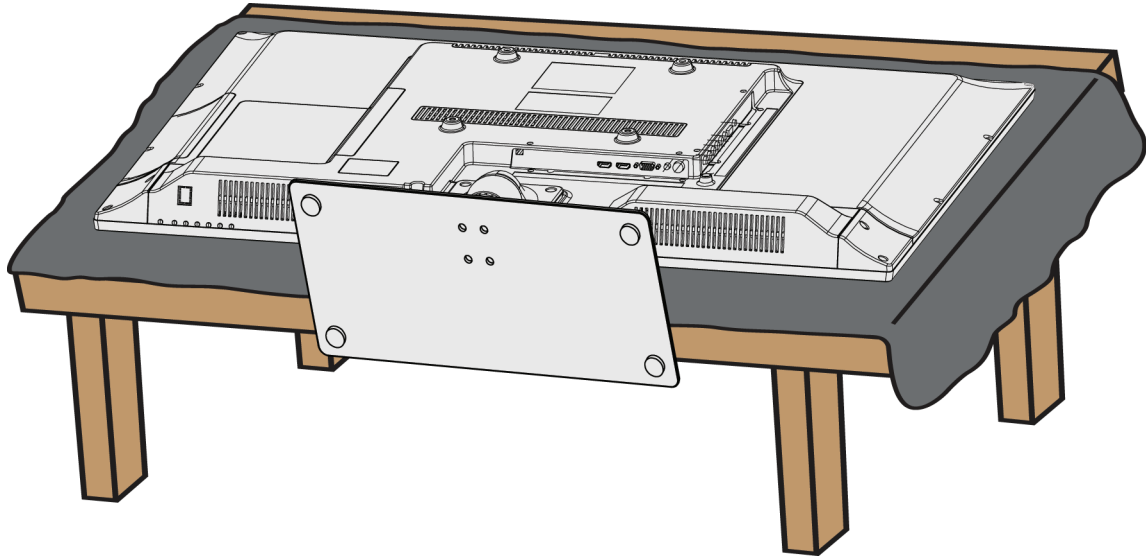

- 2 Remove the four screws that secure the stand column to your TV, then remove the stand assembly. If the stand is installed, you do not need to remove the stand.

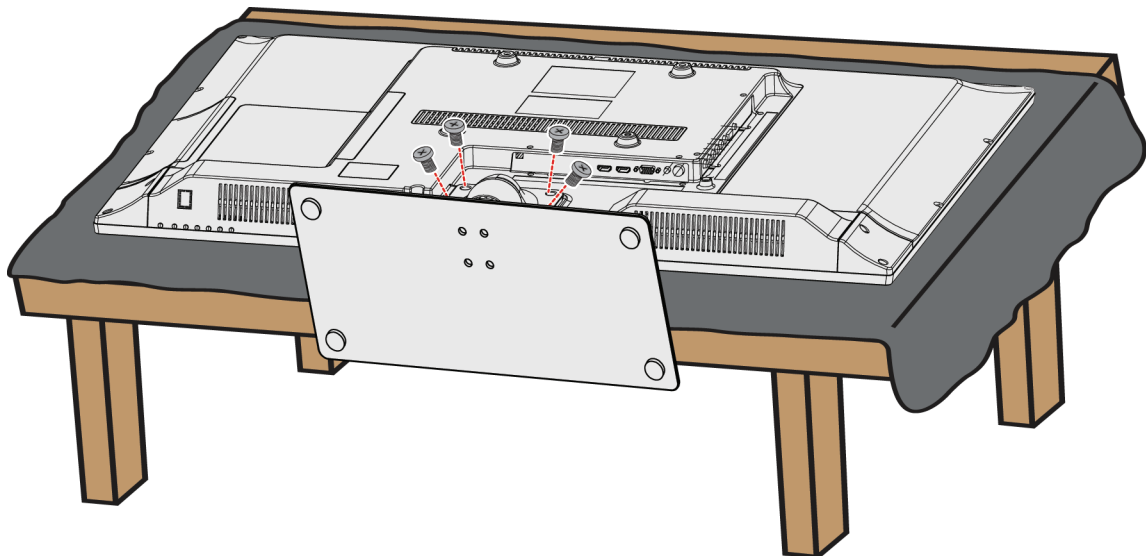

- 3 Attach the wall-mount bracket to your TV using the mounting holes on the back of your TV. See the instructions that came with the wall-mount bracket for information about how to correctly hang your TV.

Notes

- The length of the wall-mount screws vary depending on the wall-mount bracket you purchased. See the instructions that came with the wall-mount bracket for screw lengths.
- The mounting holes on the back of your TV take type M5 screws.

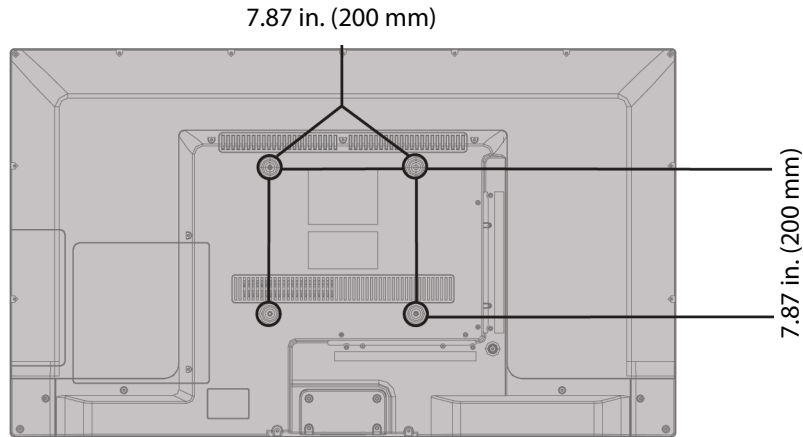

TV components

Package contents

- Remote control and batteries (2 AAA)
- TV stand column and screws (7)
- TV stand and screws (5)
- *QUICK SETUP GUIDE*
- *IMPORTANT INFORMATION*

Front

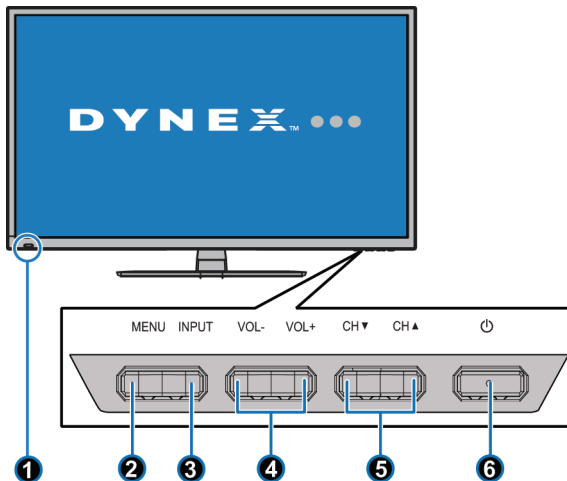

#	Item	Description
1	Remote control sensor and Power indicator	The remote control sensor receives signals from the remote control. Do not block. The power indicator: <ul style="list-style-type: none"> • Turns off when your TV is on. • Lights red when your TV is off (standby mode).
2	MENU	Press to open the on-screen menu. For more information, see "Using the on-screen menu" on page 37.
3	INPUT	Press to open the <i>INPUT SOURCE</i> list, press CH▲ or CH▼ to select the video input source, then press INPUT again. For more information, see "Selecting the video input source" on page 36. In menu mode, press to confirm selections.
4	VOL-/VOL+	Press to increase or decrease the volume.
5	CH▼/CH▲	Press to go to the next or previous channel in the channel list. For more information, see "Selecting a channel" on page 38.
6	⏻ (power)	Press to turn your TV on or off (standby mode). Warning: When your TV is off, power still flows through it. To completely disconnect power, unplug the power cord.

Side jacks

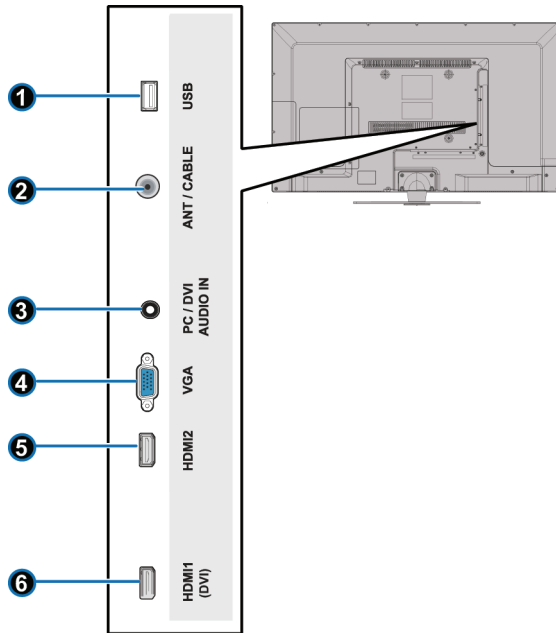

#	Item	Description
1	USB	Connect a USB flash drive to this jack to view compatible JPEG picture files. For more information, see "Connecting a USB flash drive" on page 28 and "Using a USB flash drive" on page 39.
2	ANT/CABLE	Connect an antenna or cable TV to this jack. For more information about connecting a cable box using coaxial, see "Coaxial (good)" on page 17. For information about connecting an antenna or direct cable, see "Connecting an antenna or cable TV (no box)" on page 18.
3	PC/DVI AUDIO IN	Connect the audio for a computer to this jack. For more information see "VGA (good)" on page 27. OR Connect the audio for a DVI device to this jack. For more information see, "DVI (same as HDMI but requires an audio connection)" on page 14 or 26.
4	VGA	Connect the video (VGA) for a computer to this jack. For more information, see "VGA (good)" on page 27.
5	HDMI2	Connect an HDMI device to this jack. For more information, see "HDMI (best)" on page 13, 19, 22, or 25.
6	HDMI1 (DVI)	Connect an HDMI device to this jack. For more information, see "HDMI (best)" on page 13, 19, 22, or 25. OR Connect the video for a DVI device to this jack. For more information, see "DVI (same as HDMI but requires an audio connection)" on page 14 or 26.

Back

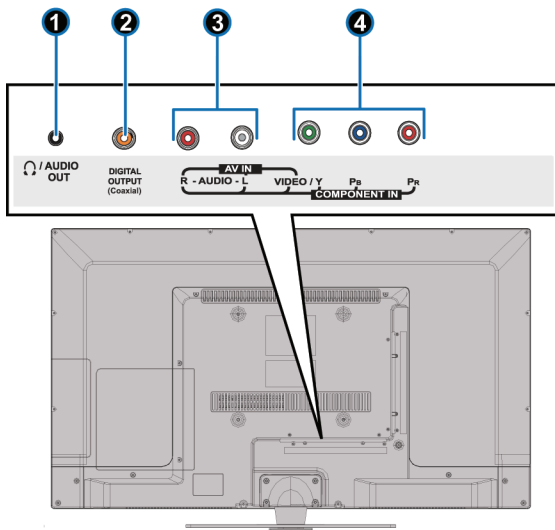

#	Item	Description
1	🎧/AUDIO OUT	Connect headphones, an analog speaker system or a sound bar to this jack. For more information, see "Analog audio" on page 31.
2	DIGITAL OUTPUT (Coaxial)	Connect a digital speaker system or sound bar to this jack to listen to TV audio through the connected speakers. For more information, see "Digital audio" on page 30.
3	AUDIO L and R	Connect the audio for a component video device to these jacks. For more information, see "Component video (better)" on page 15, 20, or 23. OR Connect the audio for a composite video device to these jacks. For more information, see "AV (composite video) (good)" on page 16, 21, or 24.
4	VIDEO/Y, Pb, Pr OR VIDEO/Y	The VIDEO/Y jack works as one of the component video jacks or as the AV (composite) video jack. Connect the video for a component video device to these jacks. For more information, see "Component video (better)" on page 15, 20, or 23. OR Connect the video for an AV (composite video) device to the VIDEO/Y jack. For more information, see "AV (composite video) (good)" on page 16, 21, or 24.

Remote control

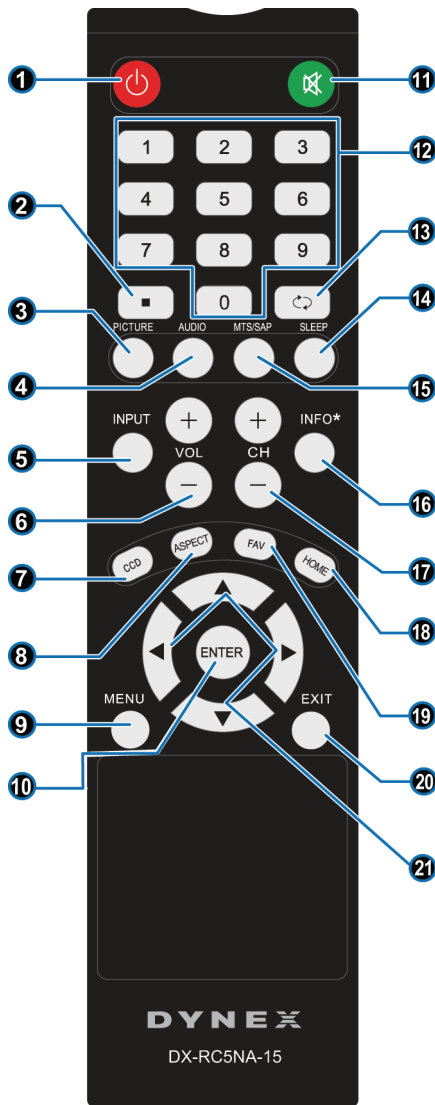





#	Button	Description
7	CCD	Press to turn closed captioning on or off. You can select CC On , CC Off , or CC On When Mute . See "Turning closed captioning on or off" on page 52.
8	ASPECT	Press to change how the picture looks on the screen (aspect ratio). See the Aspect Ratio option in "Adjusting the TV picture" on page 43.
9	MENU	Press to open the on-screen menu.
10	ENTER	Press to confirm selections or changes.
11	MUTE	Press to mute the sound. Press again to restore the sound.
12	Numbers	Press to enter channel numbers and the parental control password.
13	RECALL	Press to go to the last viewed channel.
14	SLEEP	Press to set the sleep timer. See "Setting the sleep timer" on page 52.
15	MTS/SAP	In analog TV mode, press to select Stereo , Mono , or SAP . In digital TV mode, press to select an alternate audio language, if available. See "Adjusting sound settings" on page 45.
16	INFO*	Press to display TV status information, such as the channel number, channel name (if available), or signal source. See "Viewing channel information" on page 38.
17	CH+ / CH-	Press to go to the next or previous channel in the channel list. See "Selecting a channel" on page 38.
18	HOME	Press to open the on-screen menu.
19	FAV	Press to open the <i>Favorites</i> channel list. See "Setting up a favorite channel list" on page 57 and "Viewing a favorite channel" on page 57.
20	EXIT	Press to close the on-screen menu.
21	Directional Arrows	Press to navigate through the on-screen menus and adjust settings.

#	Button	Description
1	Power	Press to turn your TV on or off (Standby mode). Warning: When your TV is off, power still flows into it. To disconnect power, unplug the power cord.
2	Sub-channel	Press to enter a digital sub-channel number. See "Selecting a channel" on page 38.
3	PICTURE	Press to select the picture mode. You can select Vivid , Standard , Energy Savings , or Custom . See "Adjusting the TV picture" on page 43.
4	AUDIO	Press to select an audio mode. You can select Standard , Theater , Music , News , or Custom . See "Adjusting sound settings" on page 45.
5	INPUT	Press to open the <i>INPUT SOURCE</i> list, then press ▲ or ▼ to select a video input source. See "Selecting the video input source" on page 36.
6	VOL+ / VOL-	Press to increase or decrease the volume.

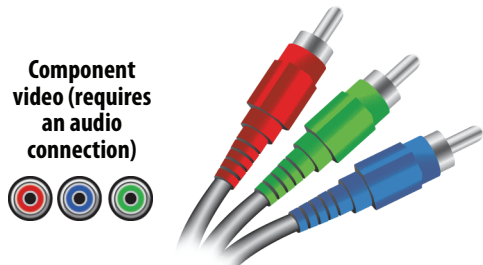
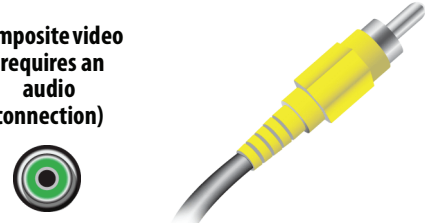
What connection should I use?

Your TV has several connection types for connecting devices to your TV.
 For the best video quality, you should connect a device to the best available connection.
 Use the following tables to identify cables:

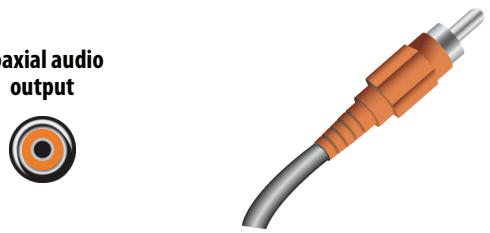
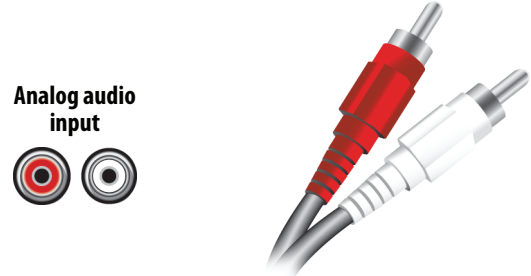
Video quality	Connection type and jack	Cable connector
Best (use this if your devices have HDMI)	HDMI video/audio	
Better than composite or coaxial	Component video (requires an audio connection)	
Better than coaxial	Composite video (requires an audio connection)	
Good	Coaxial video/audio	

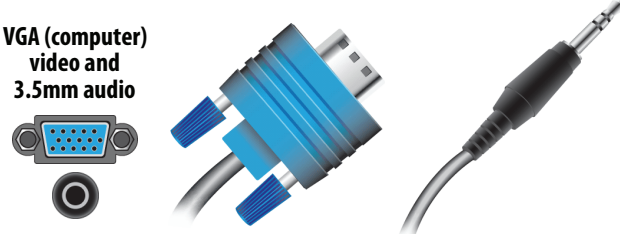
Connection type and jack	Cable connectors
Coaxial audio output	
Analog audio input	
3.5mm analog audio output	
VGA (computer) video and 3.5mm audio	

You can use the **HDMI1 (DVI)** jack on your TV to connect a DVI device to your TV. For more information, see "DVI (same as HDMI but requires an audio connection)" on page 14 or page 26.

- Cautions**
- Check the jacks for position and type before making any connections.
 - Loose connections can result in image or color problems. Make sure that all connections are tight and secure.
 - The external audio/video equipment shown may be different from your equipment. If you have questions, refer to the documentation that came with your equipment.
 - Always unplug the power cord when connecting external equipment.

Connecting a cable or satellite box

Many cable or satellite TV boxes have more than one connection type. To get the best video, you should use the best connection type available. For more information, see "What connection should I use?" on page 12.

HDMI (best)

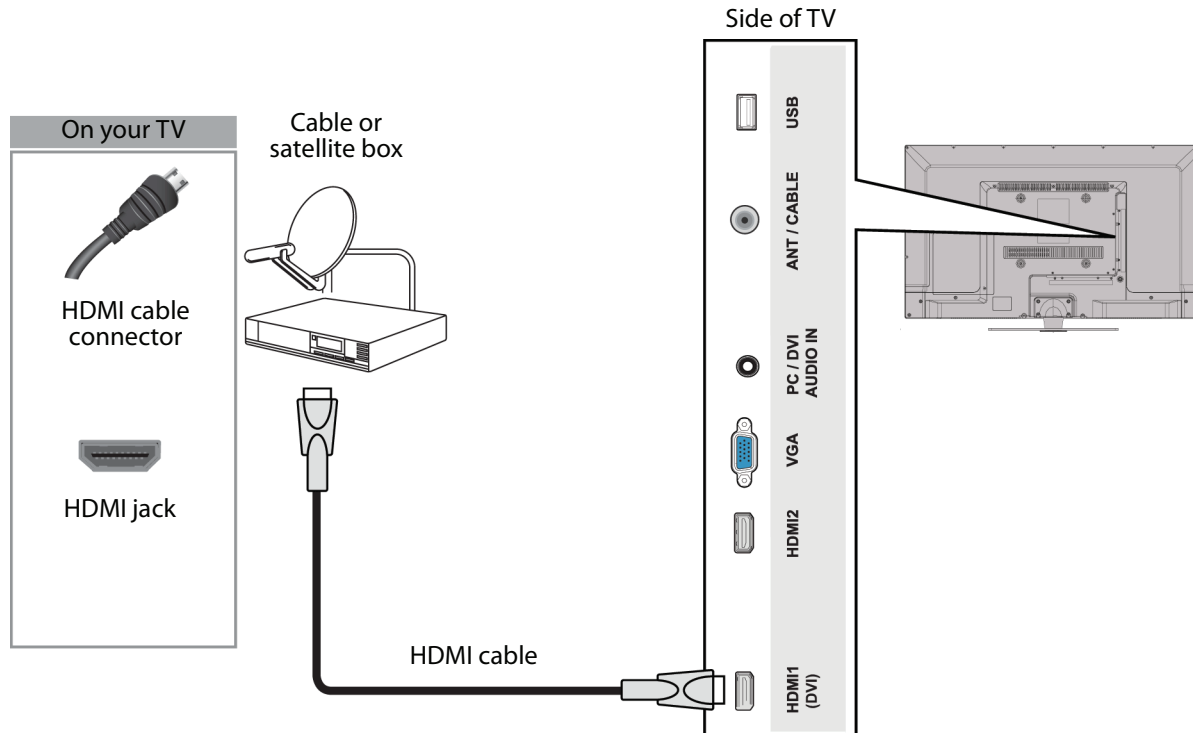

- 1 Make sure that your TV's power cord is unplugged and all connected equipment is turned off.
- 2 Connect the incoming cable from the cable wall jack to the cable-in jack on the cable or satellite box.
- 3 Connect an HDMI cable (not provided) to one of the **HDMI** jacks on the side of your TV and to the **HDMI OUT** jack on the cable or satellite box.
- 4 Plug your TV's power cord into a power outlet, turn on your TV, then turn on the cable or satellite box.
- 5 Press **INPUT** to open the *INPUT SOURCE* list.
- 6 Press **▲** or **▼** to highlight **HDMI1** or **HDMI2**, then press **ENTER**.

Note

An HDMI cable carries both audio and video. You do not need to use any audio cables.

DVI (same as HDMI but requires an audio connection)**Notes**

You must use the **HDMI1 (DVI)** jack to connect a cable or satellite box using DVI. If you use another HDMI jack, you will not hear sound from the TV speakers.

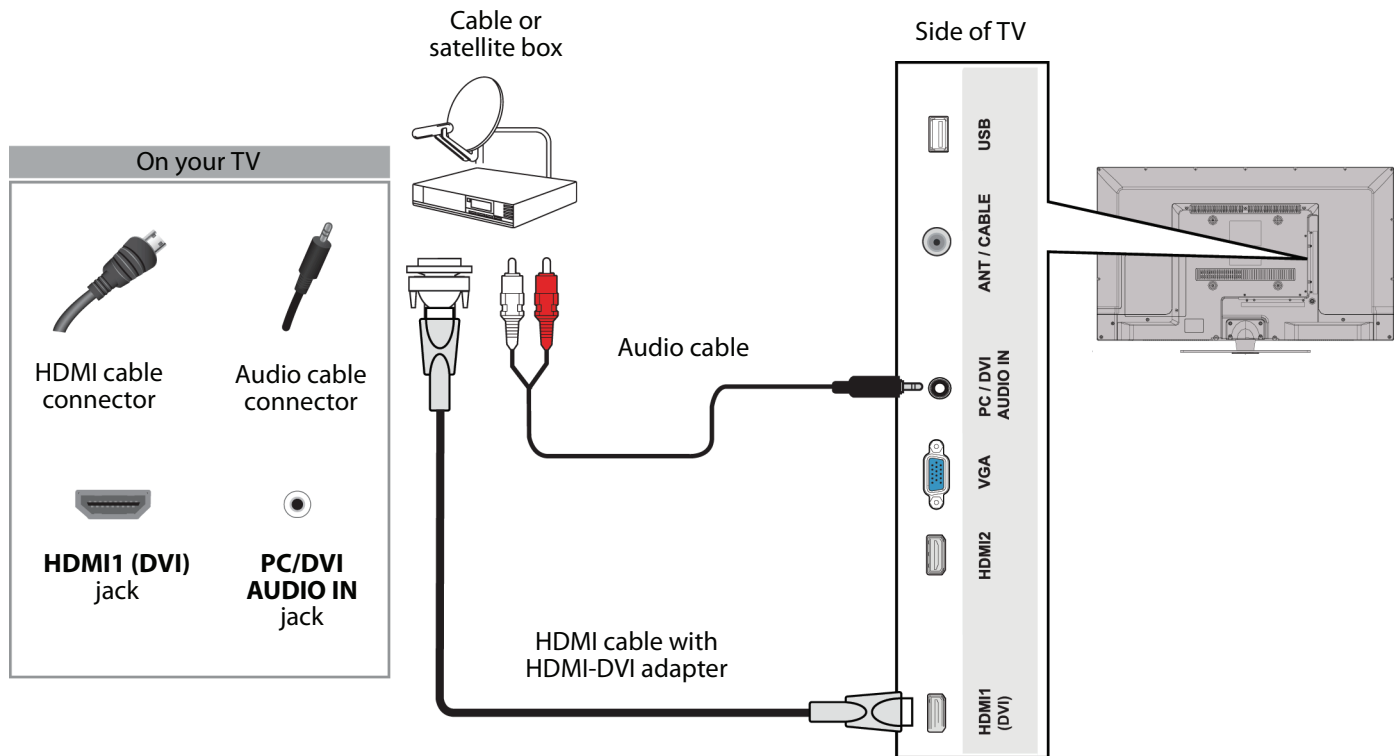

- 1 Make sure that your TV's power cord is unplugged and all connected equipment is turned off.
- 2 Connect the incoming cable from the cable wall jack to the cable-in jack on the cable or satellite box.
- 3 Connect an HDMI-DVI adapter (not provided) to one end of an HDMI cable (not provided), then connect the adapter to the **DVI OUT** jack on the cable or satellite box.
- 4 Connect the other end of the cable to the **HDMI1 (DVI)** jack on the side of your TV.
- 5 Connect an audio cable (not provided) to the **PC/DVI AUDIO IN** jack on the side of your TV and to the **AUDIO OUT** jacks on the cable or satellite box.

Note

When you connect the audio using the **PC/DVI AUDIO IN** jack, the audio output is analog.

- 6 Plug your TV's power cord into a power outlet, turn on your TV, then turn on the cable or satellite box.
- 7 Press **INPUT** to open the *INPUT SOURCE* list.
- 8 Press **▲** or **▼** to highlight **HDMI1**, then press **ENTER**.

Component video (better)

Note

Cables are often color-coded to match color-coded jacks.

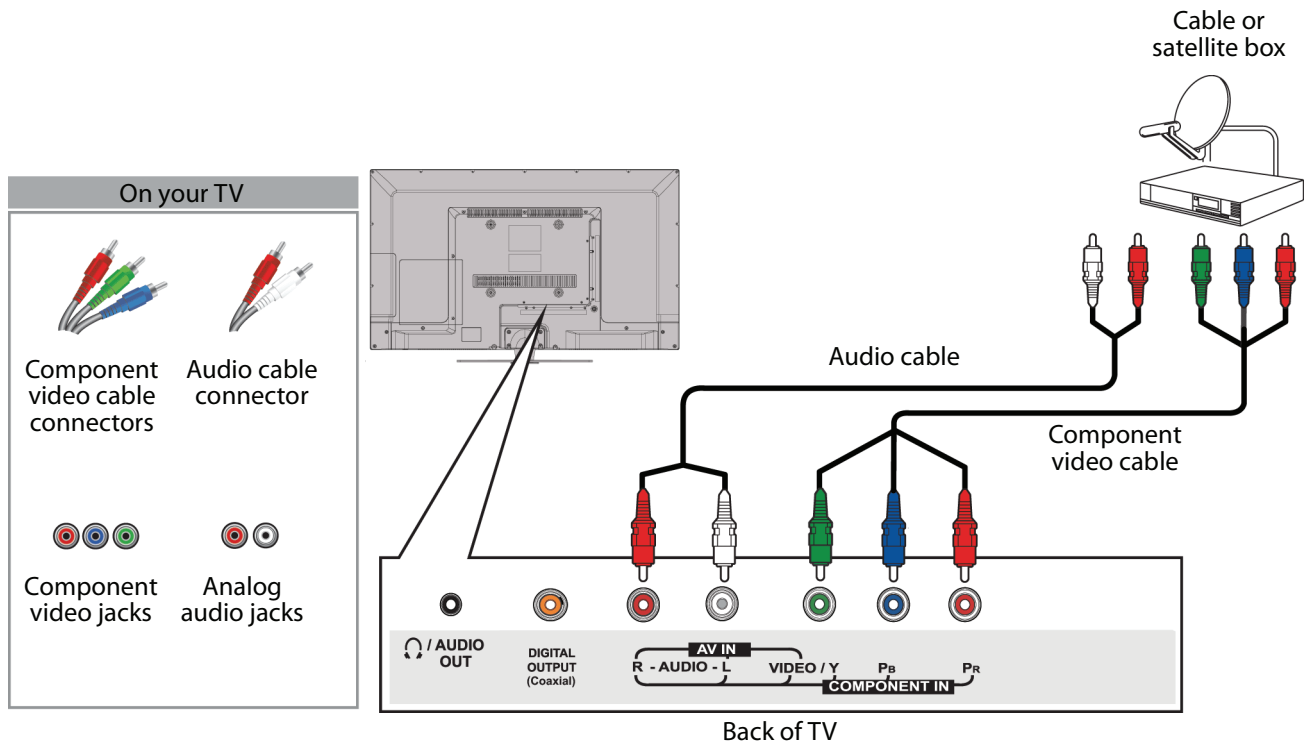

- 1 Make sure that your TV's power cord is unplugged and all connected equipment is turned off.
- 2 Connect the incoming cable from the cable wall jack to the cable-in jack on the cable or satellite box.
- 3 Connect a component video cable (not provided) to the **VIDEO/Y, PB,** and **PR** video jacks on the back of your TV and the component video out jacks on the cable or satellite box.
- 4 Connect an audio cable (not provided) to the **AUDIO L** and **R** jacks on the back of your TV and to the audio out jacks on the cable or satellite TV box.

Notes

- The **VIDEO/Y, PB,** and **PR** video jacks (used to connect a component device) share the **AUDIO L** and **R** jacks with the **VIDEO/Y** jack (used to connect an AV device).
- When you connect the audio using the **AUDIO L** and **R** jacks, the audio output is analog.

- 5 Plug your TV's power cord into a power outlet, turn on your TV, then turn on the cable or satellite box.
- 6 Press **INPUT** to open the **INPUT SOURCE** list.
- 7 Press **▲** or **▼** to highlight **Comp/AV**, then press **ENTER**.

AV (composite video) (good)

Notes

- Cables are often color-coded to match color-coded jacks.
- The yellow video connector on the AV cable connects to the green **VIDEO/Y** jack.

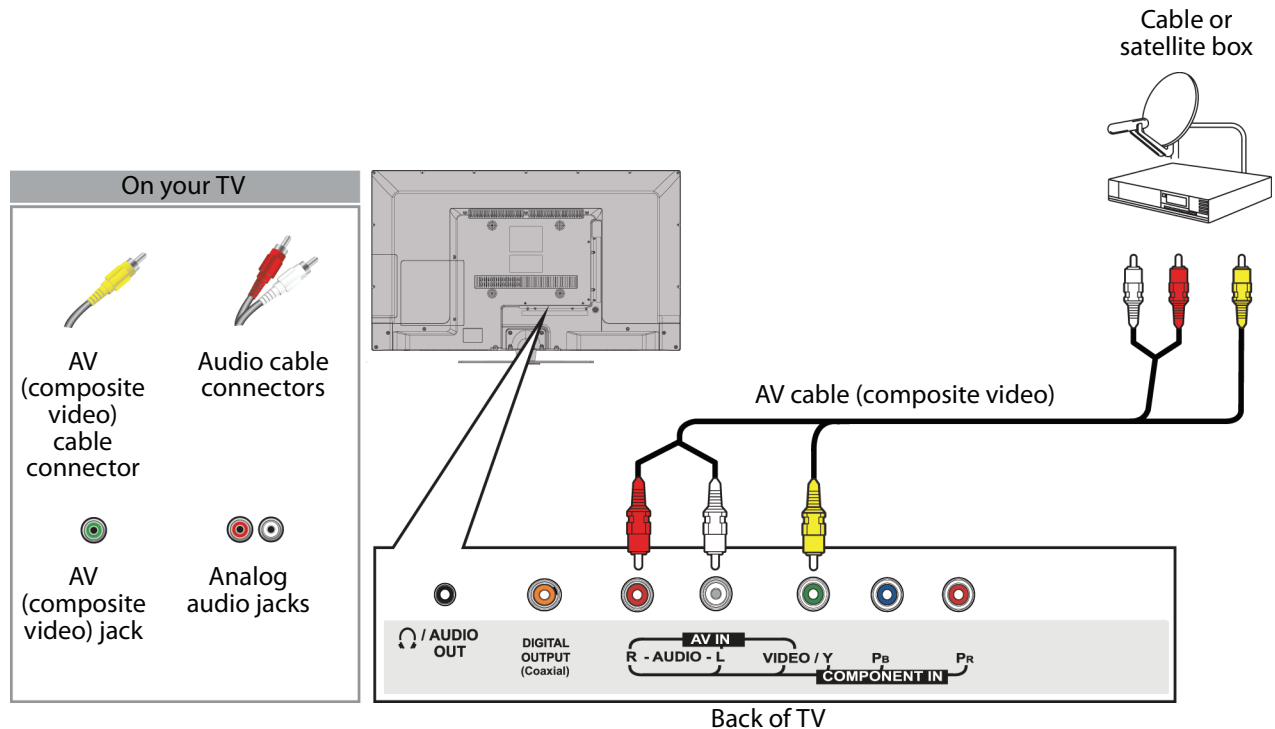

- 1 Make sure that your TV's power cord is unplugged and all connected equipment is turned off.
- 2 Connect the incoming cable from the cable wall jack to the cable-in jack on the cable or satellite box.
- 3 Connect an AV cable (not provided) to the **VIDEO/Y** jack and **AUDIO L** and **R** jacks on the back of your TV and to the composite video and audio out jacks on the cable or satellite box.

Notes

- The **VIDEO/Y**, **PB**, and **PR** video jacks (used to connect a component device) share the **AUDIO L** and **R** jacks with the **VIDEO/Y** jack (used to connect a composite device).
- When you connect the audio using the **AUDIO L** and **R** jacks, the audio output is analog.

- 4 Plug your TV's power cord into a power outlet, turn on your TV, then turn on the cable or satellite box.
- 5 Press **INPUT** to open the *INPUT SOURCE* list.
- 6 Press **▲** or **▼** to highlight **Comp/AV**, then press **ENTER**.

Coaxial (good)

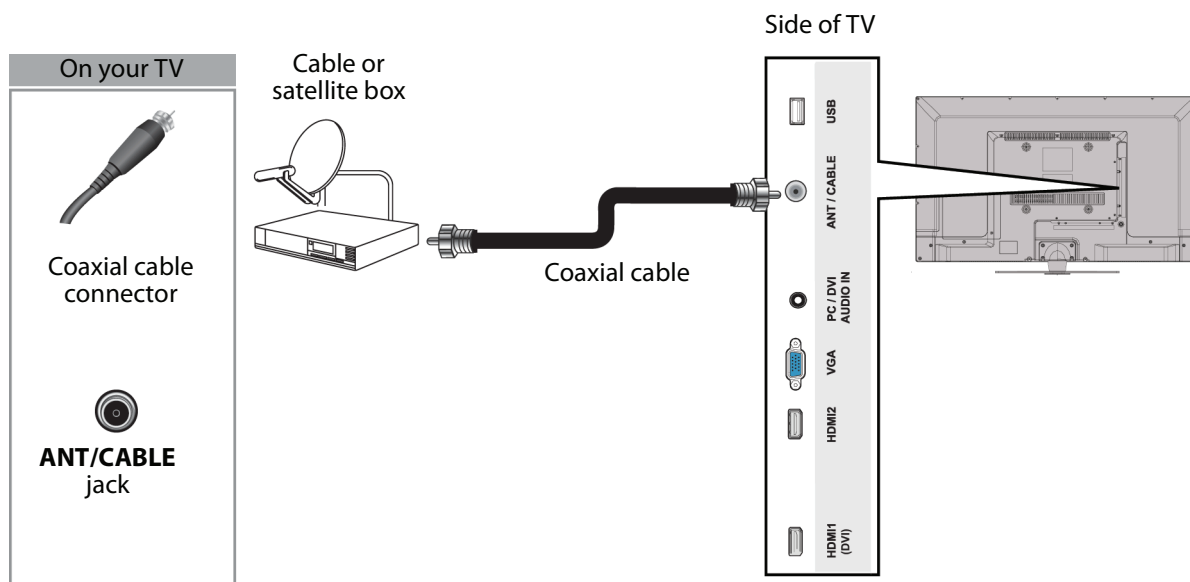

- 1 Make sure that your TV's power cord is unplugged and all connected equipment is turned off.
- 2 Connect the incoming cable from the cable wall jack to the cable-in jack on the cable or satellite box.
- 3 Connect a coaxial cable (not provided) to the **ANT/CABLE** jack on the side of your TV and to the antenna or cable TV wall jack.
- 4 Plug your TV's power cord into a power outlet, turn on your TV, then turn on the cable or satellite box.
- 5 Press **INPUT** to open the *INPUT SOURCE* list.
- 6 Press **▲** or **▼** to highlight **TV**, then press **ENTER**.
- 7 If you cannot tune to channels you know exist, scan for channels. See "[Automatically scanning for channels](#)" on page 55.

Notes

- Use a coaxial cable to eliminate interference and noise from radio waves.
- Do not bundle the coaxial cable with the power cord or other cables.

Connecting an antenna or cable TV (no box)

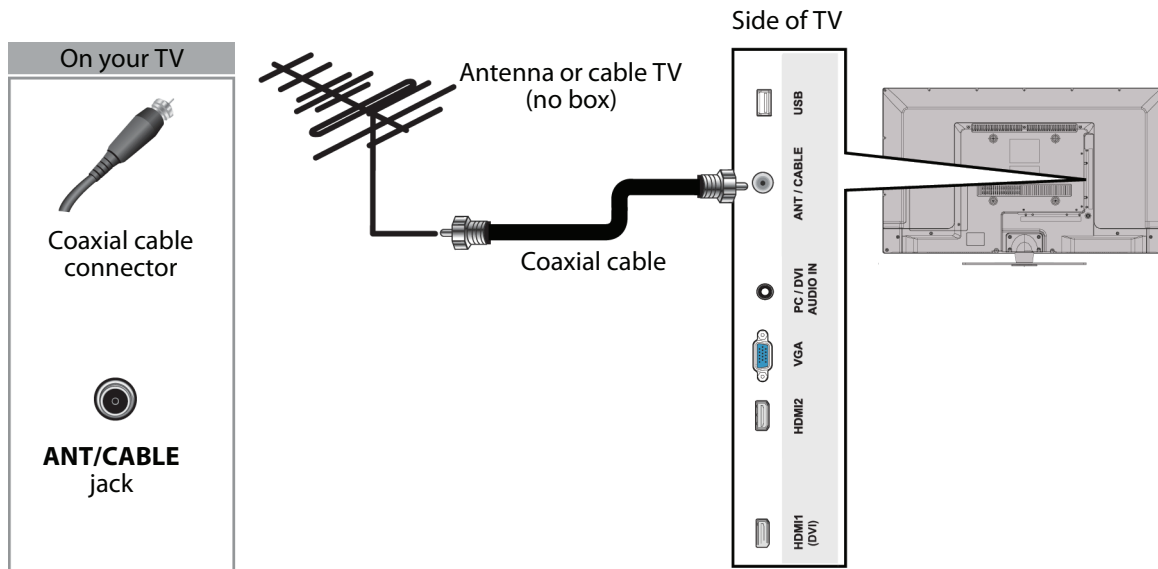

- 1 Make sure that your TV's power cord is unplugged and all connected equipment is turned off.
- 2 Connect a coaxial cable (not provided) to the **ANT/CABLE** jack on the side of your TV and to the antenna or cable TV wall jack.
- 3 Plug your TV's power cord into a power outlet, then turn on your TV.
- 4 Press **INPUT** to open the *INPUT SOURCE* list.
- 5 Press **▲** or **▼** to highlight **TV**, then press **ENTER**.
- 6 If you cannot tune to channels you know exist, scan for channels. See "[Automatically scanning for channels](#)" on page 55.

Notes

- Use a coaxial cable to eliminate interference and noise from radio waves.
- Do not bundle the coaxial cable with the power cord or other cables.
- If the antenna is not installed correctly, contact qualified service personnel to correct the problem.
- If the signal level for a channel is weak, the picture may be distorted. Adjust the antenna or use a highly directional outdoor or set-top antenna with a built-in amplifier.
- If the picture quality is good on some channels and poor on others, the problem may be caused by a poor or weak signal from the broadcaster or cable TV provider.
- If you connect to cable or satellite TV without a set-top box and experience poor picture quality, you may need to install a set-top box to improve signal reception and picture quality. Contact your cable or satellite TV provider about upgrading to a set-top box.
- Many high-definition (HD) channels upscale standard-definition (SD) content. The picture displayed on your TV is still displayed as SD, thus the picture quality will not be as clear or crisp as it would be if the content was originally recorded in HD.

Connecting a DVD or Blu-ray player

Many DVD or Blu-ray players have more than one connection type. To get the best video, you should use the best connection type available. For more information, see "What connection should I use?" on page 12.

HDMI (best)

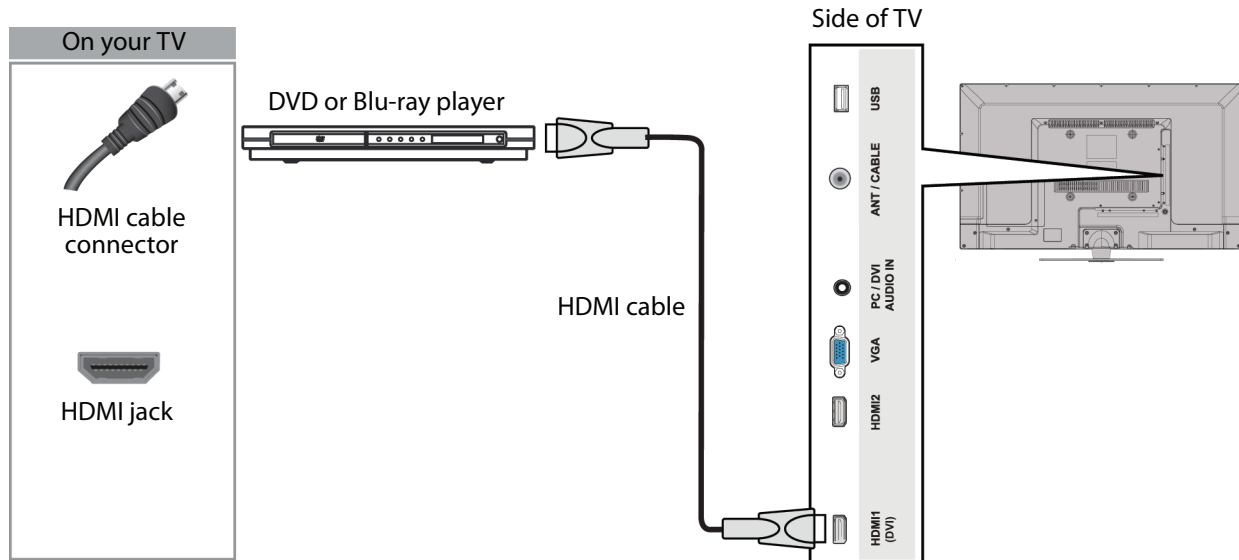

- 1 Make sure that your TV's power cord is unplugged and the DVD or Blu-ray player is turned off.
- 2 Connect an HDMI cable (not provided) to one of the **HDMI** jacks on the side of your TV and to the **HDMI OUT** jack on the DVD or Blu-ray player.
- 3 Plug your TV's power cord into a power outlet, then turn on your TV and DVD or Blu-ray player.
- 4 Press **INPUT** to open the *INPUT SOURCE* list.
- 5 Press **▲** or **▼** to highlight **HDMI1** or **HDMI2**, then press **ENTER**.

Component video (better)

Note

Cables are often color-coded to match color-coded jacks.

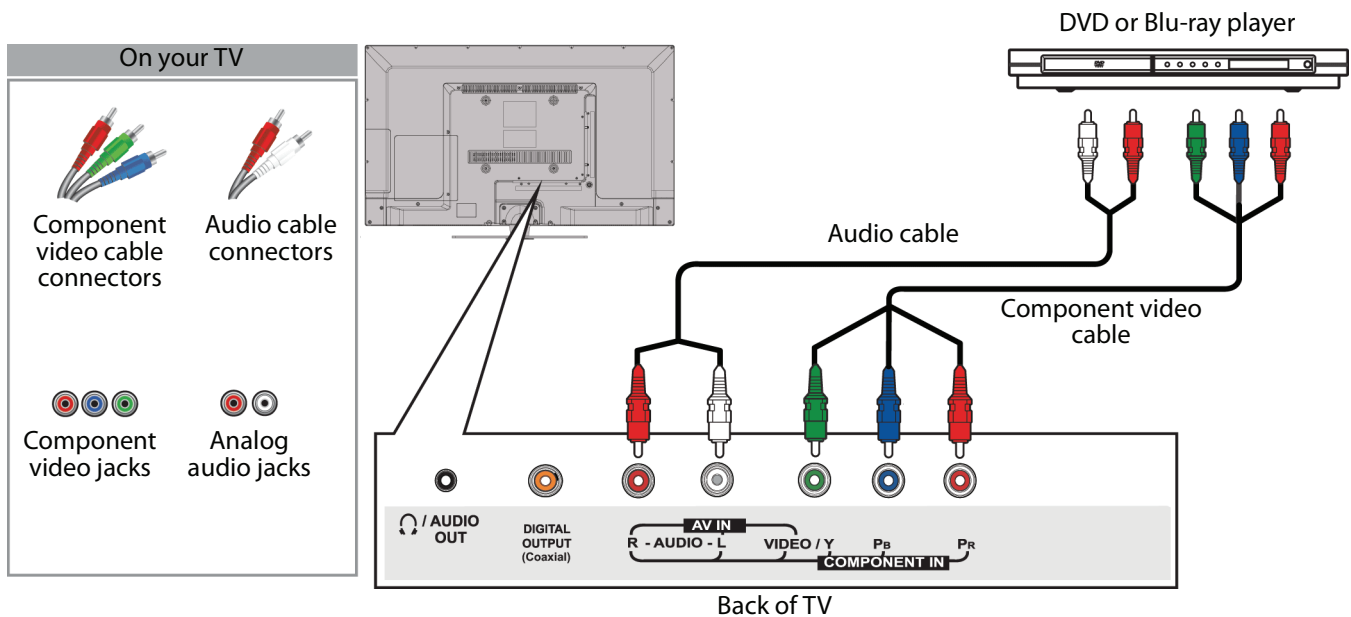

- 1 Make sure that your TV's power cord is unplugged and the DVD or Blu-ray player is turned off.
- 2 Connect a component video cable (not provided) to the **VIDEO/Y**, **PB**, and **PR** jacks on the back of your TV and to the **COMPONENT OUT** jacks on the component video device.
- 3 Connect an audio cable (not provided) to the **AUDIO L** and **R** jacks on the back of your TV and to the **L/R AUDIO OUT** jacks on the DVD or Blu-ray player.

Notes

- The **VIDEO/Y**, **PB**, and **PR** video jacks (used to connect a component device) share the **AUDIO L** and **R** jacks with the **VIDEO/Y** jack (used to connect a composite device).
- When you connect the audio using the **AUDIO L** and **R** jacks, the audio output is analog.

- 4 Plug your TV's power cord into a power outlet, then turn on your TV and DVD or Blu-ray player.
- 5 Press **INPUT** to open the **INPUT SOURCE** list.
- 6 Press **▲** or **▼** to select **COMP/AV**, then press **ENTER**.

Composite video (good)

Notes

- Cables are often color-coded to match color-coded jacks.
- The yellow video connector on the AV cable connects to the green **VIDEO/Y** jack.

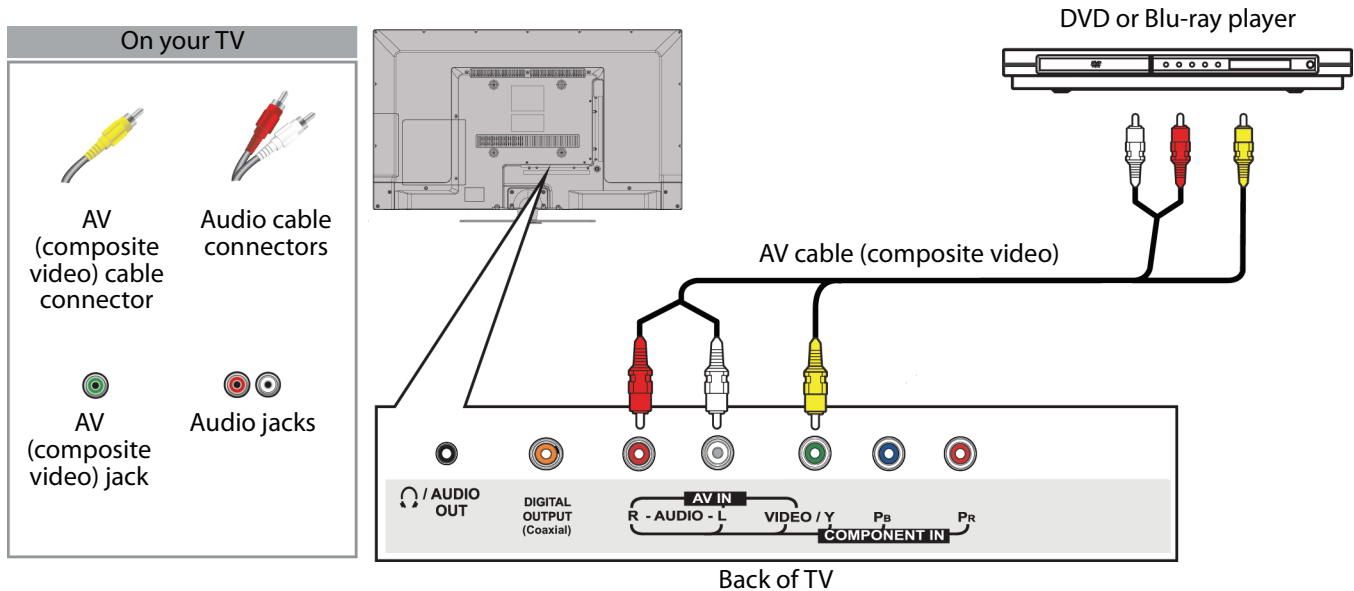

- 1 Make sure that your TV's power cord is unplugged and the DVD or Blu-ray player is turned off.
- 2 Connect an AV cable (not provided) to the **VIDEO/Y** jack and **AUDIO L** and **R** jacks on the back of your TV and to the **AV OUT** jacks on the DVD or Blu-ray player.

Notes

- The **VIDEO/Y**, **Pb**, and **Pr** video jacks (used to connect a component device) share the **AUDIO L** and **R** jacks with the **VIDEO/Y** jack (used to connect a composite device).
- When you connect the audio using the **AUDIO L** and **R** jacks, the audio output is analog.

- 3 Plug your TV's power cord into a power outlet, then turn on your TV and DVD or Blu-ray player.
- 4 Press **INPUT** to open the **INPUT SOURCE** list.
- 5 Press **▲** or **▼** to select **COMP/AV**, then press **ENTER**.

Connecting a game console

HDMI (best)

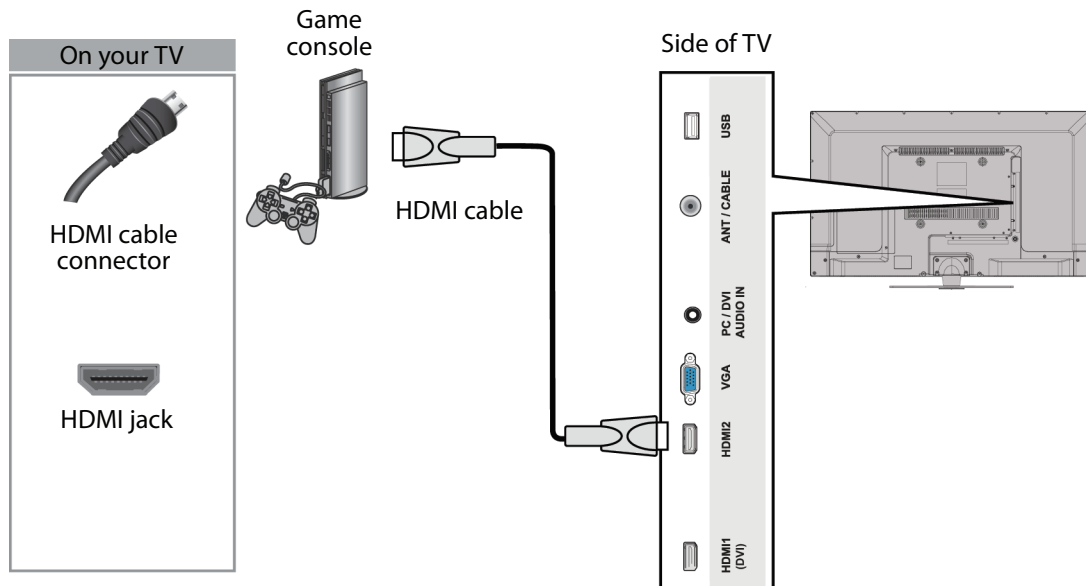

- 1 Make sure that your TV's power cord is unplugged and the game console is turned off.
- 2 Connect an HDMI cable (not provided) to one of the **HDMI** jacks on the side of your TV and to the **HDMI OUT** jack on the game console.
- 3 Plug your TV's power cord into a power outlet, then turn on your TV.
- 4 Turn on the game console, then set it to the correct output mode. For more information, see the documentation that came with the console.
- 5 Press **INPUT** to open the *INPUT SOURCE* list.
- 6 Press **▲** or **▼** to highlight **HDMI1** or **HDMI2**, then press **ENTER**.

Note

An HDMI cable carries both audio and video. You do not need to use any audio cables.

Component video (better)

Notes

- Your game console may require a special component video cable. See the documentation that came with your game console or check the manufacturer's Web site.
- Cables are often color-coded to match color-coded jacks.

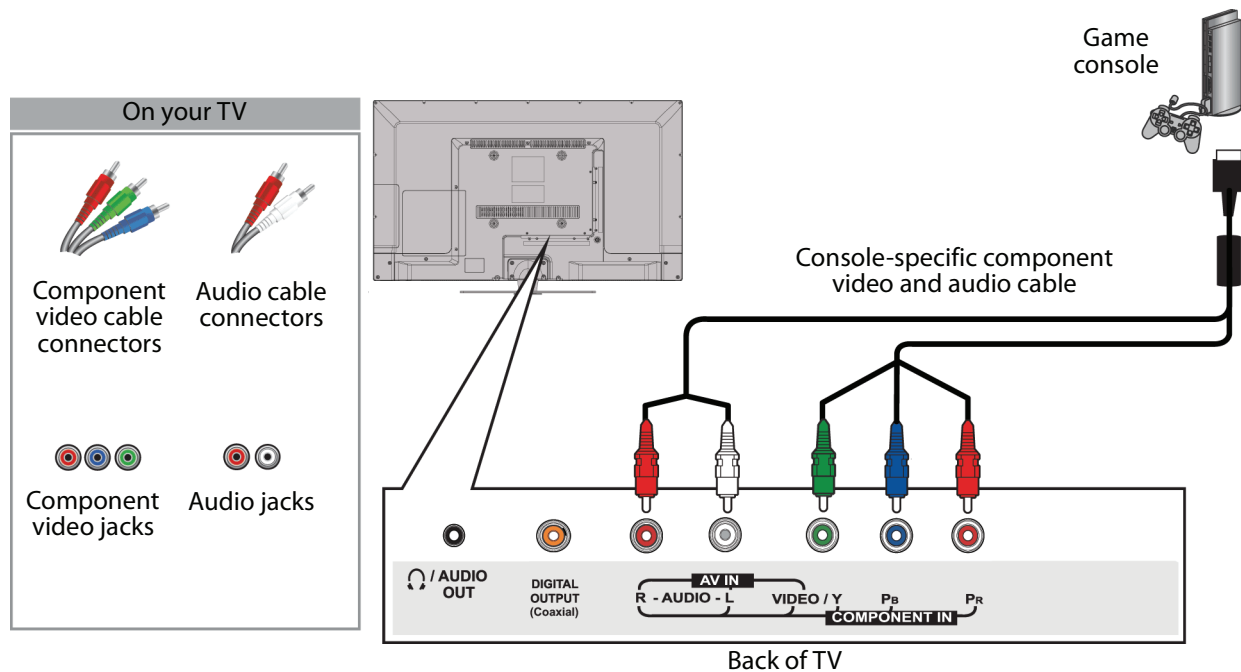

- 1 Make sure that your TV's power cord is unplugged and the game console is turned off.
- 2 Connect the video and audio connectors on the component video cable (not provided) to the **VIDEO/Y**, **PB**, and **PR** video jacks and **AUDIO L** and **R** jacks on the back of your TV and to the component jack(s) on the game console.

Notes

- The **VIDEO/Y**, **PB**, and **PR** video jacks (used to connect a component device) share the **AUDIO L** and **R** jacks with the **VIDEO/Y** jack (used to connect a composite device).
- When you connect the audio using the **AUDIO L** and **R** jacks, the audio output is analog.

- 3 Plug your TV's power cord into a power outlet, then turn on your TV.
- 4 Turn on the game console, then set it to the correct output mode. For more information, see the documentation that came with the console.
- 5 Press **INPUT** to open the *INPUT SOURCE* list.
- 6 Press **▲** or **▼** to select **Comp/AV**, then press **ENTER**.

AV (composite video) (good)

Notes

- Most game consoles come with a special AV (composite video) cable. See the documentation that came with your game console or check the manufacturer's Web site.
- Cables are often color-coded to match color-coded jacks.
- The yellow video connector on the AV cable connects to the green **VIDEO/Y** jack.

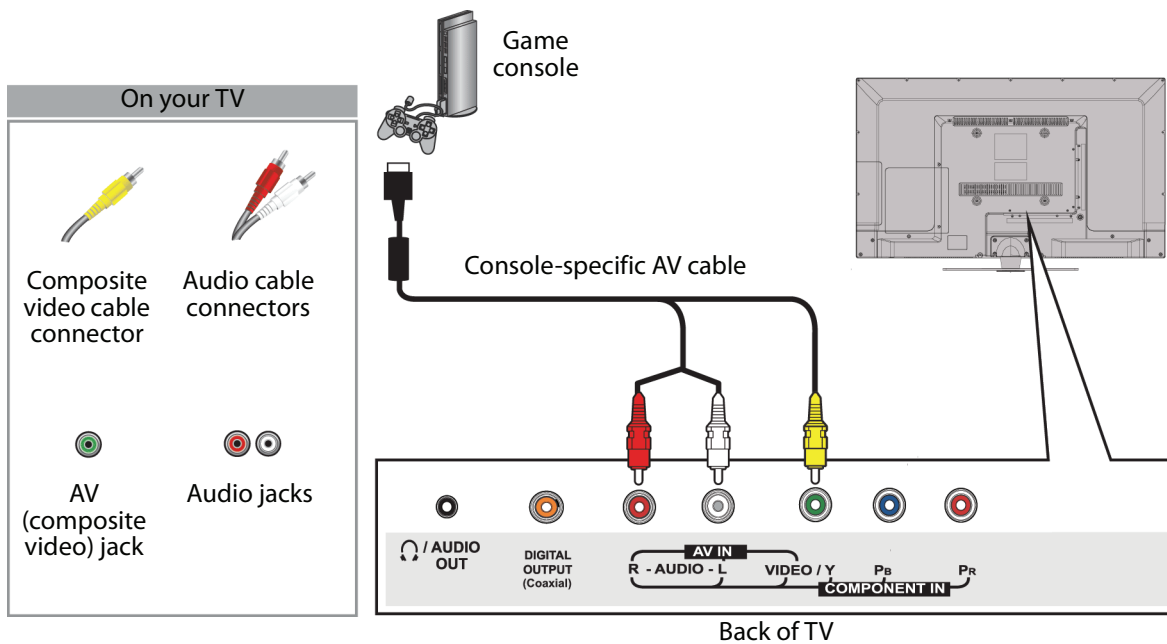

- 1 Make sure that your TV's power cord is unplugged and the game console is turned off.
- 2 Connect the video and audio connectors on the game console's AV cable (not provided) to the **VIDEO/Y** jack and **AUDIO L** and **R** jacks on the back of your TV and to the composite jack(s) on the game console.

Notes

- The **VIDEO/Y**, **PB**, and **PR** video jacks (used to connect a component device) share **VIDEO/Y** jacks with the **VIDEO/Y** jack (used to connect a composite device).
- When you connect the audio using the **AUDIO L** and **R** jacks, the audio output is analog.

- 3 Plug your TV's power cord into a power outlet, then turn on your TV.
- 4 Turn on the game console, then set it to the correct output mode. For more information, see the documentation that came with the player.
- 5 Press **INPUT** to open the *INPUT SOURCE* list.
- 6 Press **▲** or **▼** to select **Comp/AV**, then press **ENTER**.

Connecting a computer

HDMI (best)

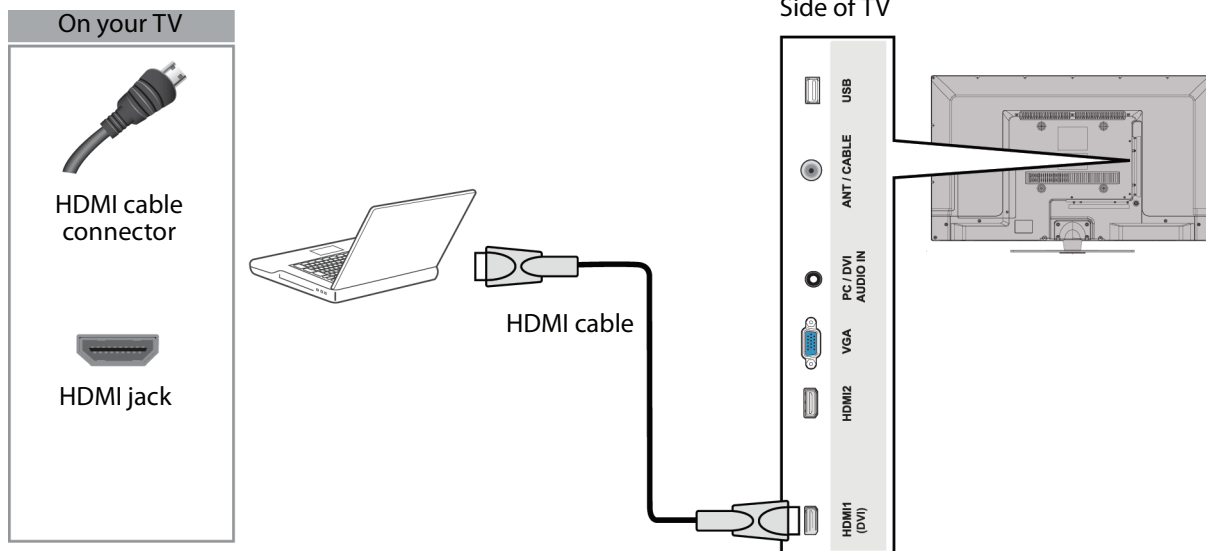

- 1 Make sure that your TV's power cord is unplugged and the computer is turned off.
- 2 Connect an HDMI cable (not provided) to one of the **HDMI** jacks on the side of your TV and to the **HDMI OUT** jack on the computer.
- 3 Plug your TV's power cord into a power outlet, then turn on your TV and the computer.
- 4 Press **INPUT** to open the *INPUT SOURCE* list.
- 5 Press **▲** or **▼** to highlight **HDMI1** or **HDMI2**, then press **ENTER**.
- 6 Adjust the display properties on the computer, if necessary.

DVI (same as HDMI but requires an audio connection)**Note**

You must use the **HDMI1 (DVI)** jack to connect a computer using DVI. If you use another HDMI jack, you will not hear sound from the TV speakers.

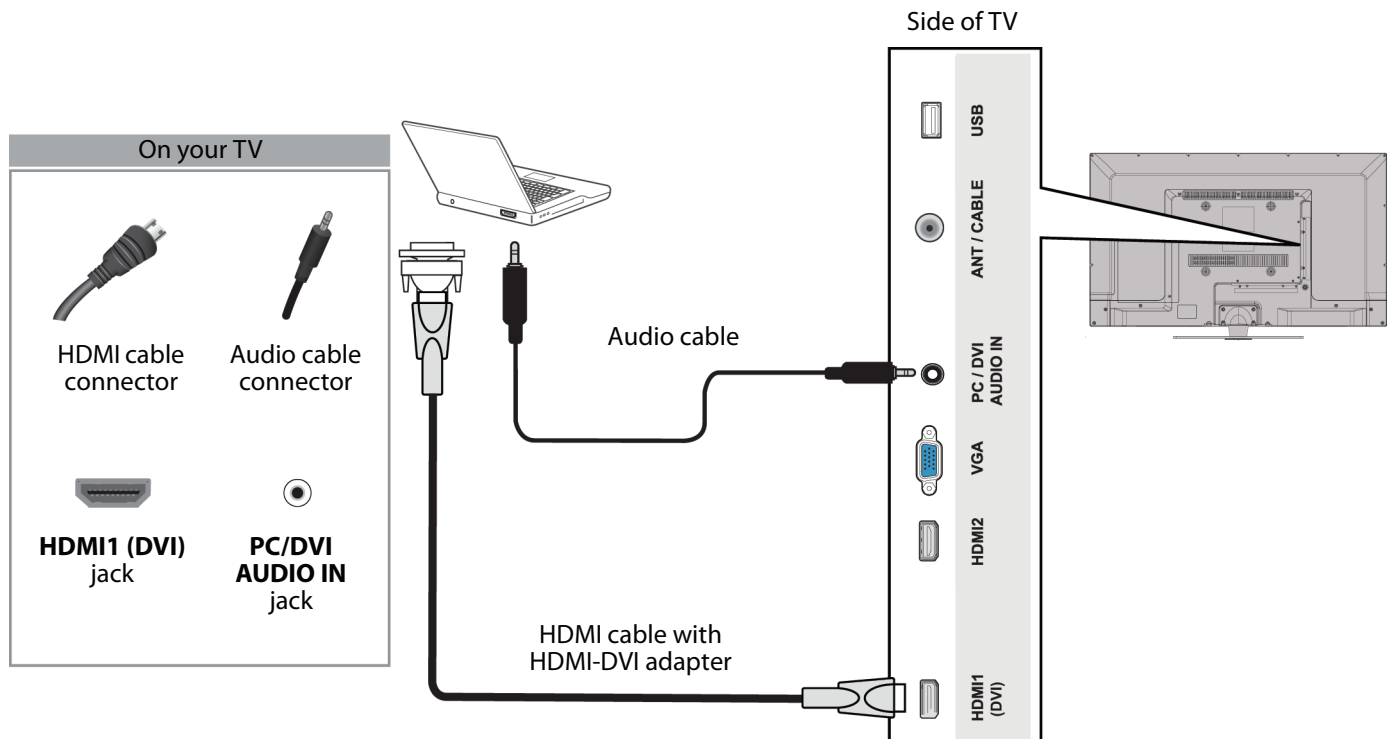

- 1 Make sure that your TV's power cord is unplugged and the computer is turned off.
- 2 Connect an HDMI-DVI adapter (not provided) to one end of an HDMI cable (not provided), then connect the adapter to the **DVI OUT** jack on the computer.
- 3 Connect the other end of the cable to the **HDMI1 (DVI)** jack on the side of your TV.
- 4 Connect an audio cable (not provided) to the **PC/DVI AUDIO IN** jack on the side of your TV and to the **AUDIO OUT** (headphone) jack on the computer.

Note

When you connect the audio using the **PC/DVI AUDIO IN** jack, the audio output is analog.

- 5 Plug your TV's power cord into a power outlet, then turn on your TV and the computer.
- 6 Press **INPUT** to open the *INPUT SOURCE* list.
- 7 Press **▲** or **▼** to select **HDMI1**, then press **ENTER**.
- 8 Adjust the display properties on the computer, if necessary.

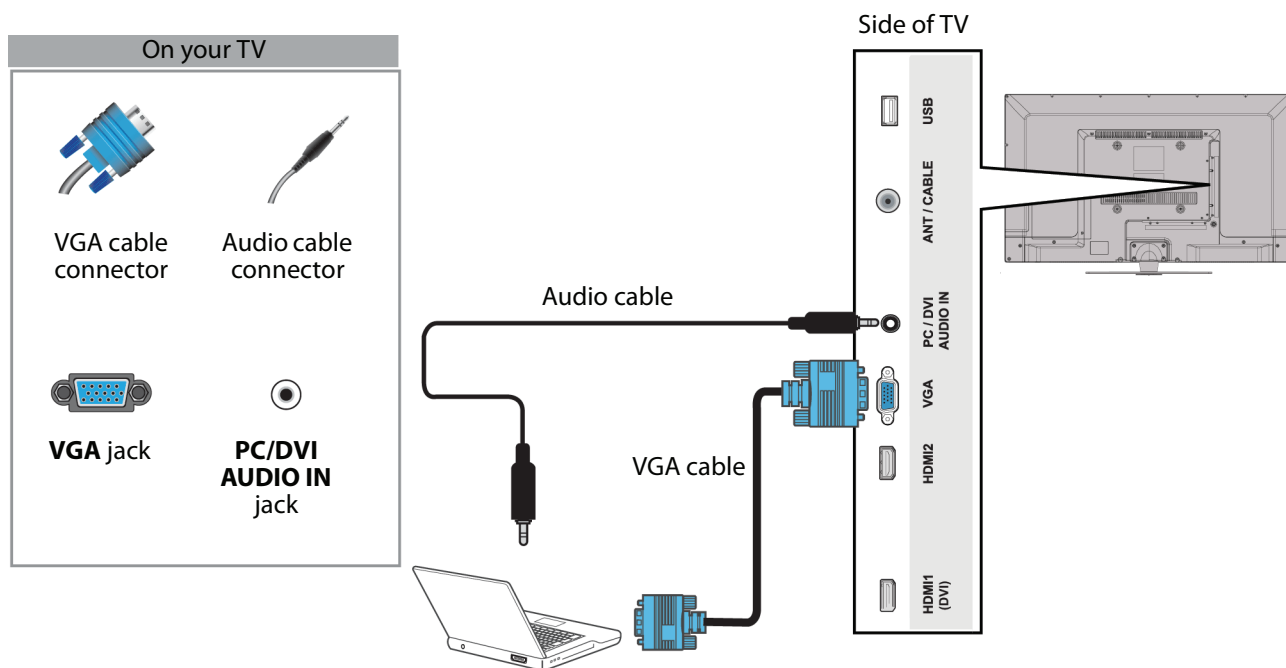
VGA (good)

- 1 Make sure that your TV's power cord is unplugged and the computer is turned off.
- 2 Connect a VGA cable (not provided) to the **VGA** jack on the back of your TV and to the **VGA** jack on the computer.
- 3 Connect an audio cable (not provided) to the **PC/DVI AUDIO IN** jack on the back of your TV and to the **AUDIO OUT** (headphone) jack on the computer.
- 4 Plug your TV's power cord into a power outlet, then turn on your TV and the computer.
- 5 Press **INPUT** to open the *INPUT SOURCE* list.
- 6 Press **▲** or **▼** to select **VGA**, then press **ENTER**.
- 7 Adjust the display properties on the computer, if necessary.

Connecting a USB flash drive

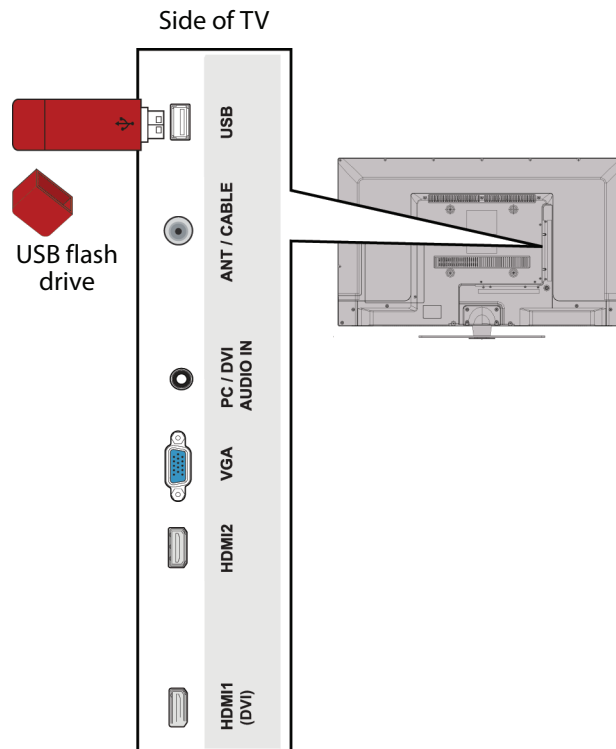

Caution

Do not remove the USB flash drive or turn off the TV while using the USB flash drive. You may lose data or damage the USB flash drive.

- 1 Plug a USB flash drive into the **USB** port on the side of your TV.
- 2 If your TV is turned on when you connect the USB flash drive, press **▲** or **▼** to select **Yes** in the message that appears. The **USB** menu opens.

OR

If you switch to a different video input source after you plug in the USB flash drive and want to switch back to the drive, press **INPUT** to open the **INPUT SOURCE** list, press **▲** or **▼** to select **USB(Photos)**, then press **ENTER**. The **USB** menu opens.

Note

The **Photos** viewer only supports JPEG format images (with ".jpg" file extensions) and not all JPEG files are compatible with your TV. For more information, see "[Using a USB flash drive](#)" on page 39.

Connecting headphones

When you connect headphones, audio plays through the headphones and the TV speakers are muted. See “[Adjusting sound settings](#)” on page 45.

Warning

Loud noise can damage your hearing. When using headphones, use the lowest volume setting on your headphones that still lets you hear the sound.

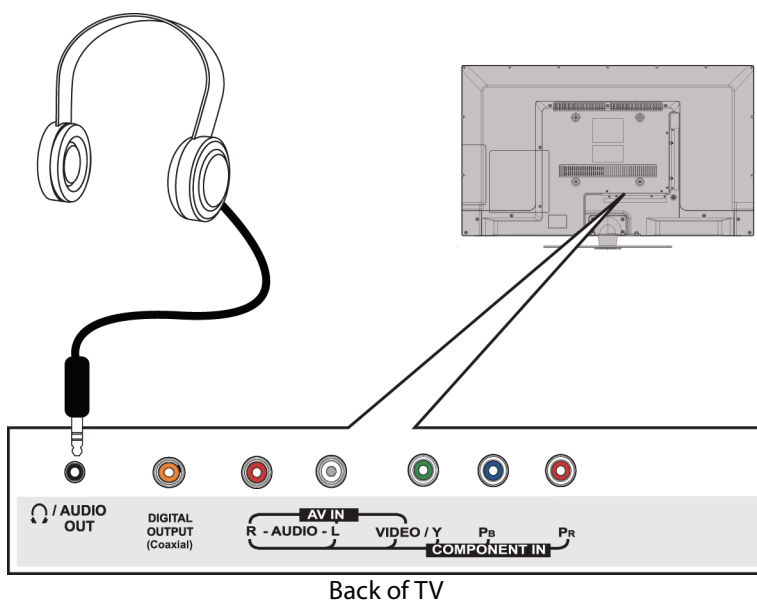

Notes

- If you connect headphones when your TV is turned off, when you turn your TV on the TV speakers are muted and the audio plays through the headphones.
- You can also connect an amplifier, home theater system, or sound bar to the **AUDIO OUT** jack.

- Connect the headphones to the **AUDIO OUT** jack on the back of your TV.

Connecting external speakers or a sound bar

Digital audio

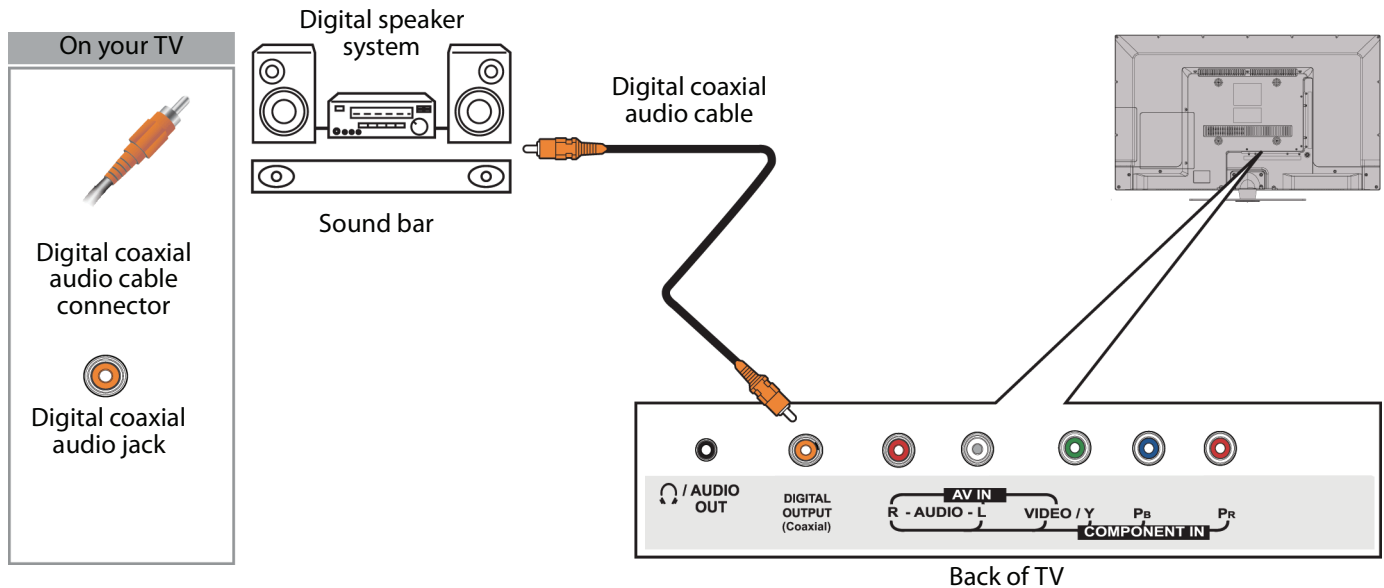

- 1 Make sure that your TV's power cord is unplugged and the digital speaker system or sound bar is turned off.
- 2 Connect a digital coaxial audio cable (not provided) to the **DIGITAL OUTPUT (Coaxial)** jack on the back of your TV and to the coaxial **AUDIO IN** jack on the digital speaker system or sound bar.
- 3 Plug your TV's power cord into a power outlet, then turn on your TV.
- 4 Turn on the digital speaker system or sound bar, then set it to the correct source. For more information, see the documentation that came with the digital speaker system or sound bar.
- 5 On your TV, set the **Digital Audio/SPDIF** option on the *Audio* menu to **PCM**. See the **Digital Audio/SPDIF** option in "[Adjusting sound settings](#)" on page 45.

Analog audio

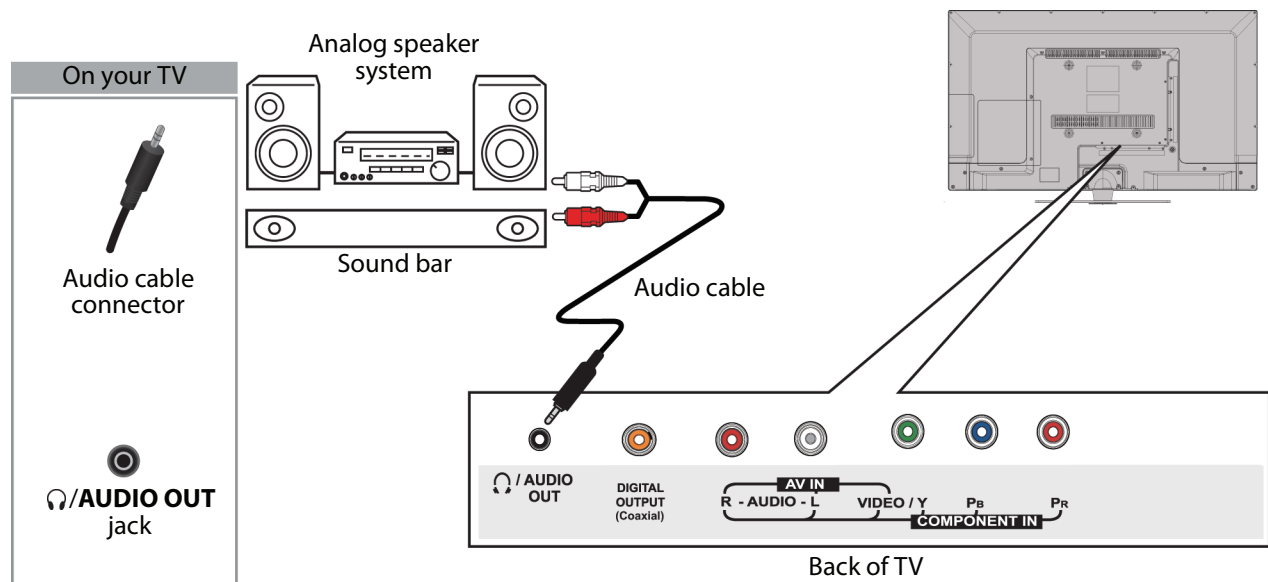

- 1 Make sure that your TV's power cord is unplugged and the analog speaker system or sound bar is turned off.
- 2 Connect an audio cable (not provided) to the **AUDIO OUT** jack on the back of your TV and to the **AUDIO IN** jacks on the analog speaker system.
- 3 Plug your TV's power cord into a power outlet, then turn on your TV.
- 4 Turn on the analog speaker system or sound bar, then set it to the correct source. For more information, see the documentation that came with the analog speaker system or sound bar.

Connecting a home theater system with multiple devices

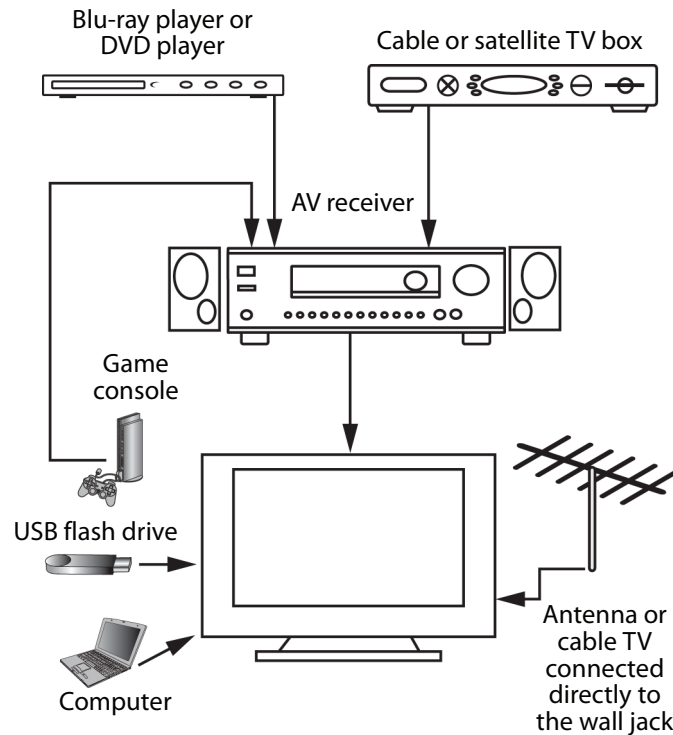

The connections you make depend on the video and audio jacks available on your devices. Refer to the documentation that came with your devices for connection information.

Just remember to use the best connection types available for the best picture and sound. For information about connection types, see ["What connection should I use?"](#) on page 12.

Connecting power

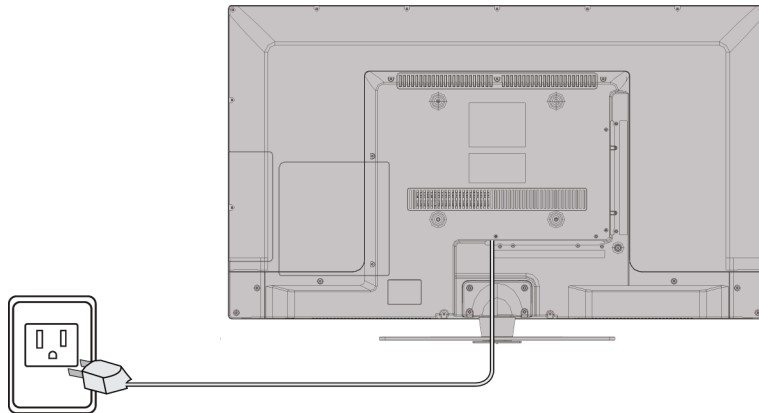

- Plug the AC power cord into a power outlet.

Notes

- Your TV should only be operated from the power source indicated on the label.
- Always unplug the power cord from the power outlet when you will not be using your TV for an extended period of time.
- The power cord is permanently attached to your TV. Do not try to unplug it from the back of your TV.

Using the remote control

Installing remote control batteries

- 1 While pressing the release latch on the back of the remote control, lift the battery compartment cover off the remote control.

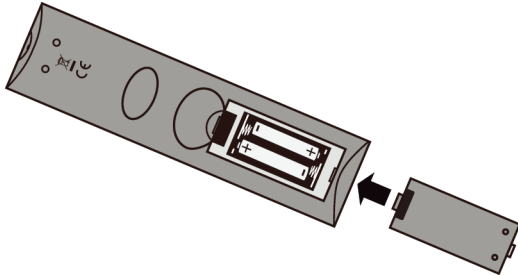

- 2 Insert two AAA batteries into the battery compartment. Make sure that you match the + and – symbols on the batteries with the + and – symbols in the battery compartment.

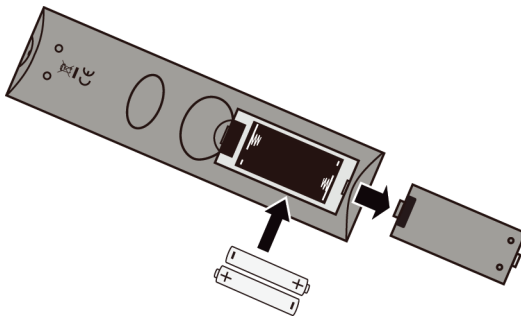

- 3 Replace the battery compartment cover.

Cautions

- Batteries should not be exposed to excessive heat, such as sunshine, heat registers, or fire.
- Battery chemicals can cause a rash. If the batteries leak, clean the battery compartment with a cloth. If chemicals touch your skin, wash immediately.
- Make sure that batteries are disposed of correctly. Do not burn or incinerate.

Notes

- Do not mix batteries of different types.
- Do not mix old and new batteries.
- Remove batteries when the charge is depleted.
- If the remote control is not going to be used for an extended period of time, remove the batteries.

Aiming the remote control

- Point the remote control towards the remote sensor on the front of your TV. For the location of the remote control sensor, see "Front" on page 8.

Turning on your TV for the first time

The first time you turn on your TV, the *Setup Wizard* opens. The *Setup Wizard* guides you through setting up basic settings including the menu language, time setting, picture mode, and the TV signal source.

- 1 Make sure that you have:

- Installed the remote control batteries. (See page 34 for details.)
- Connected an antenna, cable TV, or satellite TV. (See page 13 through 18 for details.)
- Connected the power cord. (See page 33 for details.)

- 2 Press **⏻** (power) to turn on your TV. The *Choose Your Menu Language* screen opens.



- 3 Press **▲** or **▼** to highlight the language you want, then press **ENTER**. The *Choose Your Time Setting* screen opens.



- 4 Press **▲** or **▼** to highlight **Style**, then press **◀** or **▶** to select **Manual** (to set the date and time manually) or **Auto** (to set the date and time automatically from a TV signal source based on the time zone you select).

Note

If you select **Auto**, the displayed time is incorrect until your TV gets the correct time from a TV signal source.

- 5 If you selected **Auto** for **Style**, press **▲** or **▼** to highlight **Time Zone**, then press **◀** or **▶** to select your time zone. You can select **Eastern, Central, Mountain, Pacific, Alaska, Hawaii, Newfoundland, or Atlantic**.
- 6 If you selected **Auto** for **Style**, press **▲** or **▼** to highlight **Daylight Savings**, then press **◀** or **▶** to select **On** (if your viewing area observes Daylight Savings Time) or **Off** (if your viewing area does not observe Daylight Savings Time).
- 7 If you selected **Manual** for **Style**, set the date by pressing **▲** or **▼** to highlight **Year, Month, or Day**, then pressing **◀** or **▶** to adjust the setting.
- 8 If you selected **Manual** for **Style**, set the time by pressing **▲** or **▼** to highlight **Time**, then pressing **◀** or **▶** to select the hour, minute, or AM/PM field. Press **▲** or **▼** to adjust the setting.
- 9 Press **ENTER**. The *Choose Your Picture Mode* screen opens.



- 10 Press **▲** or **▼** to highlight **Home Mode** or **Retail Mode**, then press **ENTER**.

If you selected **Retail Mode**, a message asks you to confirm your selection. **Retail Mode** is not an energy savings mode. Select **Yes** to continue using **Retail Mode**, or select **No** to change your selection, then press **ENTER**.

The *Choose Your TV Source* screen opens.

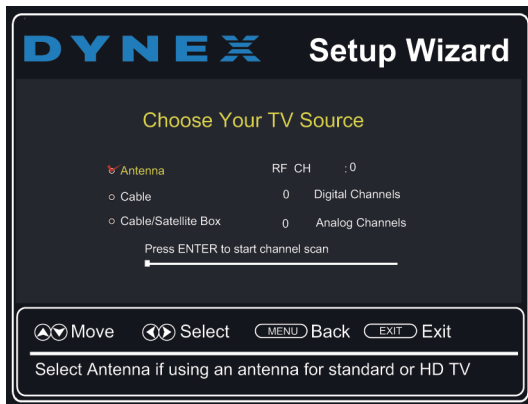

- 11 Press **▲** or **▼** to highlight **Antenna, Cable, or Cable/Satellite Box**, then press **ENTER**.

- A If you are using an antenna for a standard or HD TV signal, select **Antenna**. Your TV scans for available channels. The scan may take several minutes. During scanning your TV searches for digital channels first. When the digital channel search is complete, a message appears asking if you want to search for analog channels. Select **Yes** to continue searching for analog channels, or select **No** to stop searching for channels.
- B If your cable is connected directly to the TV (using no tuner box), select **Cable**. Your TV scans for available channels. The scan may take several minutes.

Note

The channel scan can take up to 20+ minutes. You can press **EXIT** to stop the auto channel search, but you will need to run the auto channel search again to create a channel list.

- C If your cable or satellite TV is connected to your TV through a tuner box, select **Cable/Satellite Box**. Your TV does not need to scan for channels. A message tells you to select the correct input source. Go to the next step.
- 4 To watch TV, press **INPUT**, press **▲** or **▼** to highlight the video input source for your TV in the *INPUT SOURCE* list, then press **ENTER**.
 - If your TV is connected to an antenna, cable TV (no box), or cable or satellite TV box using a coaxial cable, select **TV**.
 - If your TV is connected to a cable or satellite box using an HDMI cable or HDMI cable with a DVI adapter, select **HDMI1** or **HDMI2**.
 - If your TV is connected to a cable or satellite box using a component video cable, select **COMP/AV**.
 - If your TV is connected to a cable or satellite box using a composite video cable, select **COMP/AV**.

Understanding the basics

Turning your TV on or off

- 1 Make sure that the power cord is plugged into a power outlet.
- 2 Press **⏻** (power) to turn on your TV. The power indicator LED turns off.
- 3 Press **⏻** (power) again to turn off your TV. Your TV enters Standby mode and the power indicator turns red.

Warning

When your TV is in standby mode, it is still receiving power. To completely disconnect power, unplug the power cord.

Note

If your TV does not receive an input signal for several minutes, it automatically goes into standby mode.

Selecting the video input source

- 1 Turn on your TV.
- 2 If you want to use a device connected to a video input (such as a DVD or Blu-ray player), turn on the device.
- 3 Press **INPUT**. The *INPUT SOURCE* list opens.

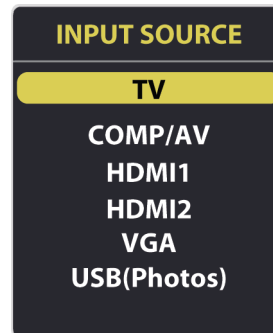

- 4 Press **▲** or **▼** to highlight the video input source, then press **ENTER**.

Using the on-screen menus

Notes

- Depending on the signal source selected, you may see different options on your screen. The following menus are shown in TV mode.
- Menu items that are not selectable are grayed out.
- The screens shown in this manual are for explanation purposes and may vary from the actual screens on your TV.

Picture menu (TV mode)

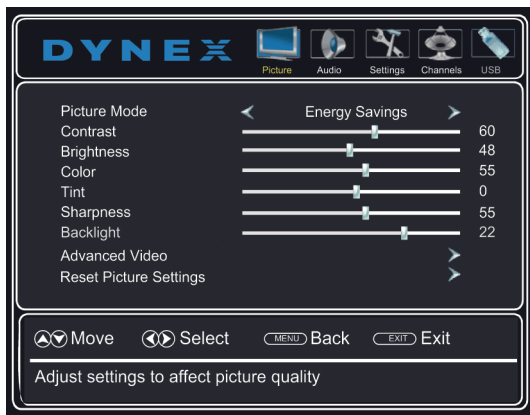

Audio menu (TV mode)

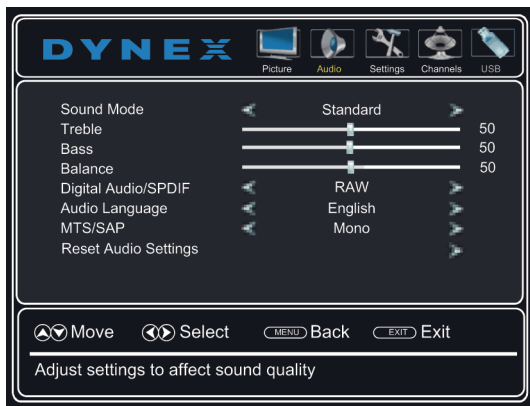

Settings menu (TV mode)



Channels menu (TV mode)



USB menu (USB mode)



Navigating the menus

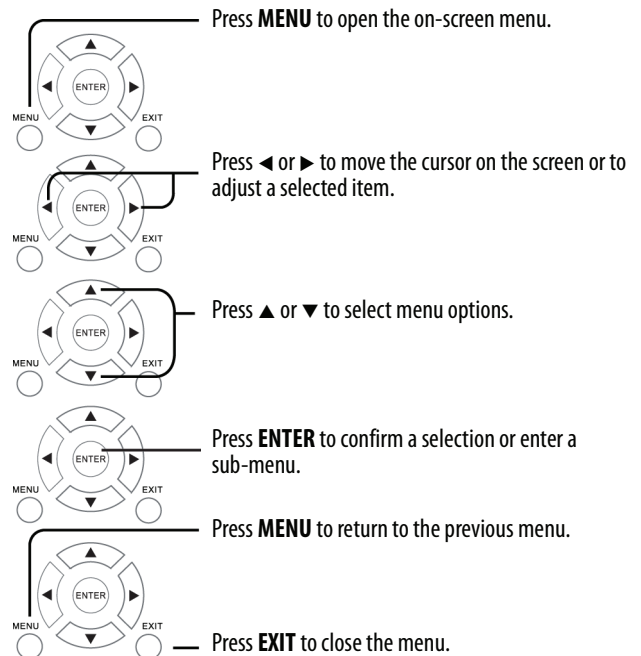

Selecting a channel

- Press **CH+** or **CH-** to go to the next or previous channel on the memorized channel list.
- Press the number buttons to enter the analog or main digital channel number you want, then wait for the channel to change or press **ENTER** to immediately change the channel.
- To select a digital sub-channel, press the number buttons to select the main digital channel, press **■**, then press the number button for the sub-channel. Wait for the channel to change, or press **ENTER** to immediately change the channel. For example, to tune to channel 5.1, press **5**, **■**, then **1**.

Note

Button presses must be within three seconds of each other.

- Press **↶** (return) to go to the last viewed channel.
- Press **FAV** to open the favorite channel list, press **▲** or **▼** to highlight a channel, then press **ENTER**.

Note

If a list has more than one page, press **▲** or **▼** to scroll through the pages.

Adjusting the volume

- Press **VOL+** or **VOL-** to increase or decrease the volume.
- Press **⊘** (mute) to turn off the sound. Press **⊘** (mute) again to turn the sound back on.

Viewing channel information

- Press **INFO*** to view an information banner. The information banner shows the current program information such as channel number, video input source, and resolution.
 - Digital channel information—Displays the channel number, channel label, broadcast program name, TV rating, signal type, audio information, resolution, CC mode, and current time.
 - Analog channel information—Displays channel number, channel label (if present), signal type, and audio information.

Using a USB flash drive

You can connect a USB flash drive to your TV to view compatible JPEG pictures.

Notes

- The JPEG picture viewer only supports JPEG format images (with ".jpg" file extensions).
- Not all JPEG files are compatible with your TV.

Switching to USB mode

- 1 Make sure that you have connected the USB flash drive to the USB port on your TV.
- 2 If your TV is turned on when you connect the USB flash drive, press **▲** or **▼** to highlight **Yes** in the message that appears, then press **ENTER**. The **USB** menu opens.

OR

If you connected the USB flash drive, then changed to a different video input source, press **INPUT** to open the **INPUT SOURCE** list, press **▲** or **▼** to highlight **USB(Photos)**, then press **ENTER**. The **USB** menu opens.

Note

To exit USB mode, press **INPUT** to open the **INPUT SOURCE** list, then select another input source.

Browsing photos

- 1 Switch to USB mode (see "Switching to USB mode" on page 39).
- 2 Press **MENU**. The **USB** menu opens.



- 3 Press **▼** to access the menu. **Photos** is highlighted.



- 4 Press **ENTER** to access the menu. The photos menu opens with **Browse Photos** highlighted.



- 5 Press **ENTER**. The screen displays folder names and photo files stored on the USB flash drive in a thumbnail index with the first photo or folder highlighted. A control bar appears at the bottom of the screen.

Note

Photos are shown in the order they appear on the USB flash drive. They may not be listed in file name order.

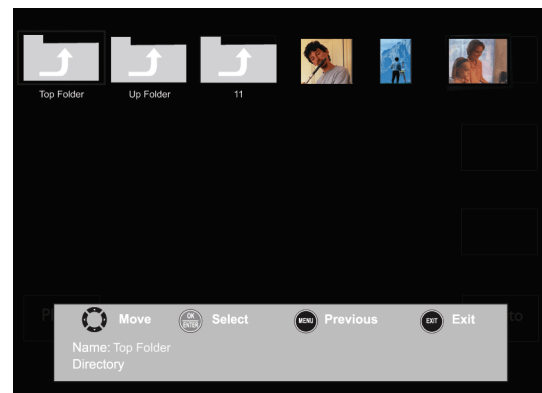

- 6 To navigate the thumbnail index screen, press:
- ▲ ▼ ◀ or ▶ to browse through the files and folders.
 - **ENTER** to view a highlighted photo full screen, or open a highlighted folder.
 - **MENU** to open the USB menu.
 - **FAV** to add or remove a photo from the favorite photo list. A heart appears on a photo that has been added to the list.
 - **EXIT** to return to the thumbnail index screen.

When a photo is displayed full screen, a control bar appears at the bottom of the photo. The file name, picture resolution, size, and date are displayed on the bottom of the control bar. If you do not press a button within 10 seconds, the control bar closes. Press **INFO** to open the control bar again.

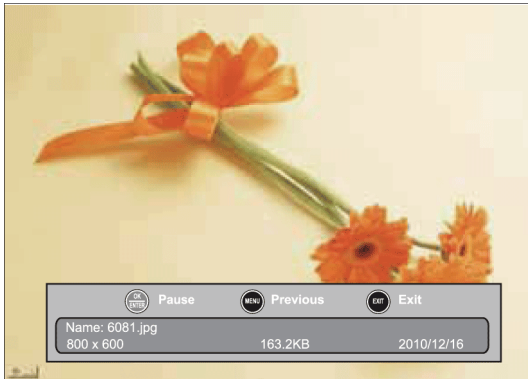

- 7 To navigate the photo screen, press:
- ◀ to go to the previous photo.
 - ▶ to go to the next photo.
 - **ENTER** to rotate the photo clockwise.
 - **ASPECT** one or more times to enlarge the image by x2 or x4, or to select **Fill** (to display the photo at its actual size). You can press ▲ ▼ ◀ or ▶ to pan the photo.
 - **EXIT** to return to the thumbnail index.
 - **MENU** to return to the USB menu.

Viewing your favorite photos

After you have created your favorite photo list, you can browse your favorite photos quickly.

- 1 Switch to USB mode (see "Switching to USB mode" on page 39).
- 2 Press **MENU**. The *USB* menu opens.

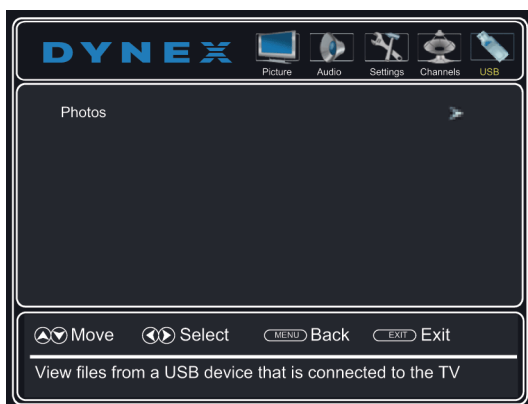

- 3 Press ▼ to access the menu. **Photos** is highlighted.



- 4 Press **ENTER** to access the menu. The photos menu opens.



- 5 Press ▲ or ▼ to highlight **Favorite Photos**, then press **ENTER**. A thumbnail index of your favorite photos opens with a control bar at the bottom of the screen.

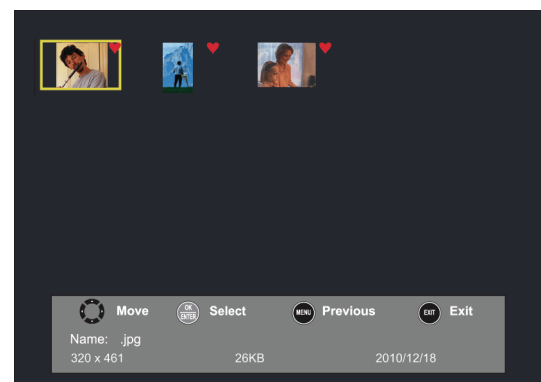

- 6 You can select photos and navigate on the photo screen the same way you browse photos. For information, see "Browsing photos" on page 39.

Viewing photos in a slideshow

- 1 Switch to USB mode (see "Switching to USB mode" on page 39).
- 2 Press **MENU**. The *USB* menu opens.



- 3 Press **▼** to access the menu. **Photos** is highlighted.



- 4 Press **ENTER** to access the menu. The photos menu opens.



- 5 Press **▲** or **▼** to highlight **View Slideshow**, then press **ENTER**. A slideshow begins with the first photo in the current folder.
- 6 To control the slideshow, press:
 - **ENTER** to pause or start the slideshow.
 - **EXIT** to exit the slideshow and return to the thumbnail index.
 - **MENU** to return to the *USB* menu.

Customizing slideshow settings

You can customize the slideshow settings by selecting **Repeat**, **Shuffle**, **Speed**, and **Transition** settings.

- 1 Switch to USB mode (see "Switching to USB mode" on page 39).
- 2 Press **MENU**. The *USB* menu opens.



- 3 Press **▼** to access the menu. **Photos** is highlighted.



- 4 Press **ENTER** to access the menu. The photos menu opens.

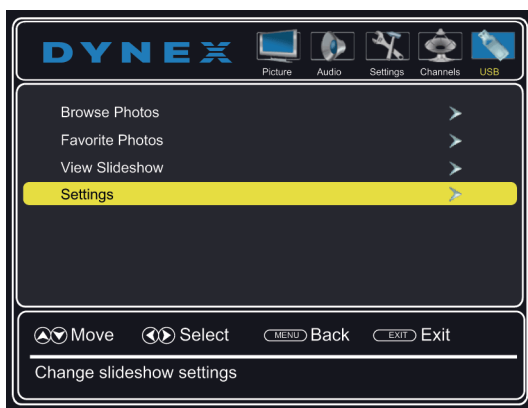

- 5 Press **▲** or **▼** to highlight **Settings**, then press **ENTER**. The photos settings menu opens.

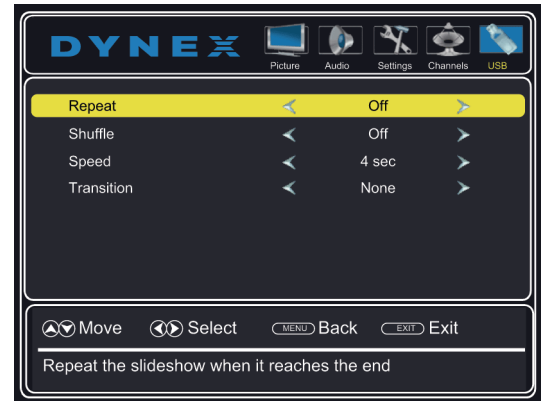

- 6 Press **▲** or **▼** to highlight an option, then press **◀** or **▶** to select a setting. You can select:
 - **Repeat**—To repeat the slideshow when it reaches the end. You can select **On** or **Off**.
 - **Shuffle**—To display the photos in random order. You can select **On** or **Off**.
 - **Speed**—To set the amount of time a photo is displayed before the next photo is shown. You can select **4 sec**, **6 sec**, or **8 sec**.
 - **Transition**—To select the way photos transition when moving to the next file in the slideshow. You can select:
 - **None**—For no transition effect.
 - **Fade to Black**—To fade the screen to black between photos.
 - **Vertical Wipe**—To wipe the screen from top to bottom between photos.
 - **Horizontal Wipe**—To wipe the screen from left to right between photos.
 - **Random**—To randomly select a transition effect.
- 7 Press **EXIT** to close the menu.

Adjusting the picture

Adjusting the TV picture

- 1 Press **MENU**. The on-screen menu opens with the *Picture* menu displayed.

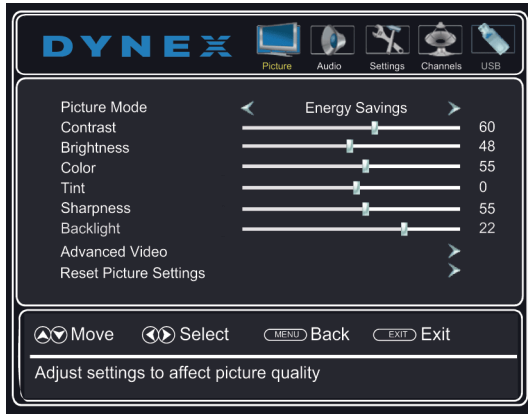

- 2 Press **▼** or **ENTER** to access the menu.
- 3 Press **▲** or **▼** to highlight an option, press **◀** or **▶** to adjust the setting, or press **▶** or **ENTER** to go to the sub-menu. You can select:
 - **Picture Mode**—Selects the picture mode. You can select:
 - **Vivid**—(a bright and vivid picture). Significantly increases the contrast, brightness, and sharpness. This selection is good for video games, animation, and in bright light environments.
 - **Standard**—(a standard picture). Moderately increases the contrast, brightness, and sharpness. This selection is good for standard TV broadcasts.
 - **Energy Savings**—(the backlight brightness is decreased). Your TV has a backlight that provides light for displaying a picture. By reducing the amount of light, your TV uses less energy.
 - **Custom**—(customized picture). Lets you manually adjust picture settings such as brightness, contrast, and sharpness.

Note



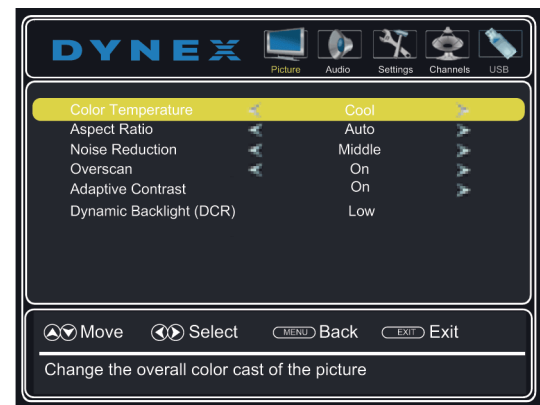

You can also press **PICTURE** on your remote control to select the picture mode.

- **Contrast**—Adjusts the brightness of the light areas of the picture.
- **Brightness**—Adjusts the brightness of the dark areas of the picture.
- **Color**—Adjusts the color intensity of the picture. A low setting may make the color look faded. A high setting may make the color look artificial.
- **Tint**—Adjusts the color balance of the picture. Use this control to make skin tones look more natural.
- **Sharpness**—Adjusts the color detail of images. If you set this control too high, dark images may appear with light or white edges.
- **Backlight**—Increasing the backlight setting increases the brightness and display performance of the screen. The higher the setting, the higher the power consumption.
- **Advanced Video**—Opens a menu where you can adjust additional video options.

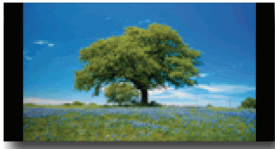

- **Color Temperature**—Selects the color temperature. You can select **Cool** (to enhance the blues), **Normal**, or **Warm** (to enhance the reds).

- **Aspect Ratio**—Adjusts how the picture fills the screen.

Aspect ratio option	Example
Normal: Original aspect ratio is preserved. Black bars are present if content is not widescreen (16:9).	
Zoom: Expands the image to fill the screen. The top and bottom of the image may be cropped.	
Wide: Use this option to view content recorded in a 16:9 (wide-screen) aspect ratio.	
Cinema: Stretches the image at the edges, but keeps a clear image in the center.	
Auto: The picture display is adjusted to the correct aspect ratio automatically (TV mode only). This setting is only active when Auto Zoom in the <i>Channels</i> menu is set to On .	

Note

You can also press **ASPECT** to select the aspect ratio.

- **Noise Reduction**—Selects the noise reduction mode to reduce picture noise (snow). You can select **Low**, **Middle**, **High**, or **Off**.
 - **Overscan**—When on, text and images extend past the screen edges to hide edge artifacts. You can select **On** or **Off**.
 - **Adaptive Contrast**—Automatically adjusts picture detail and brightness. You can select **On** or **Off**.
 - **DCR (Dynamic Backlight)**—Enhances the contrast ratio between light and dark areas of the picture. You can select **Off**, **Low**, or **High**.
- **Reset Picture Settings**—Resets all picture settings to factory mode.
 - 4 Press ◀ or ▶ to adjust the option, or press ▲ or ▼ to select a setting.
 - 5 Press **MENU** to return to the previous menu, or press **EXIT** to close the menu.

Automatically adjusting the aspect ratio

Auto Zoom automatically changes how the picture looks on the screen (aspect ratio) based on the TV program you are viewing.

- 1 Press **MENU**. The on-screen menu opens.
- 2 Press ◀ or ▶ to highlight **Channels**, then press ▼ or **ENTER**. The *Channels* menu opens.



- 3 Press ▲ or ▼ to highlight **Auto Zoom**.
- 4 Press ◀ or ▶ to select **On** (automatically adjusts the aspect ratio) or **Off** (does not automatically adjust the aspect ratio).
- 5 Press **MENU** to return to the previous menu, or press **EXIT** to close the menu.

Setting the power on picture mode

You can set the picture mode your TV uses when you turn it on.

- 1 Press **MENU**. The on-screen menu opens.
- 2 Press ◀ or ▶ to highlight **Settings**, then press ▼ or **ENTER**. The *Settings* menu opens.

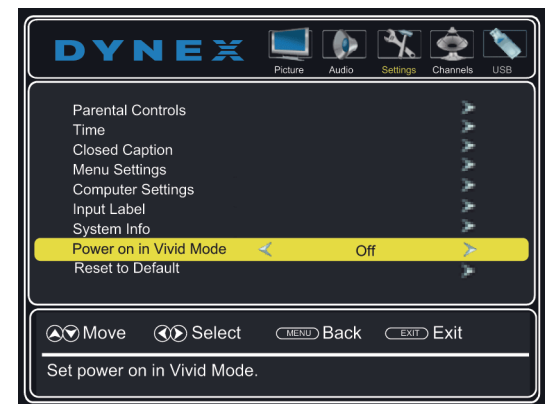

- 3 Press ▲ or ▼ to highlight **Power on in Vivid Mode**.
- 4 Press ◀ or ▶ to select **On** (when you turn on your TV, it will be in **Vivid** picture mode) or **Off** (when you turn on your TV, it will be in the picture mode it was in before you turned it off), then press **ENTER**.
- 5 Press **MENU** to return to the previous menu, or press **EXIT** to close the menu.

Adjusting the computer image

When you connect a computer to your TV using the VGA jack, you may need to adjust the computer image to improve the quality.

- 1 Press **MENU**. The on-screen menu opens.
- 2 Press **◀** or **▶** to highlight **Settings**, then press **▼**. The *Settings* menu opens.

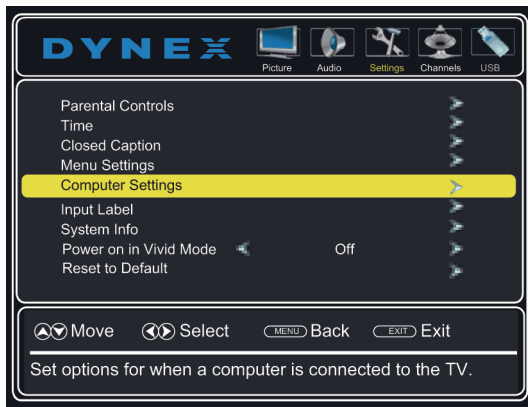

- 3 Press **▲** or **▼** to highlight **Computer Settings**, then press **ENTER**. The computer settings menu opens.

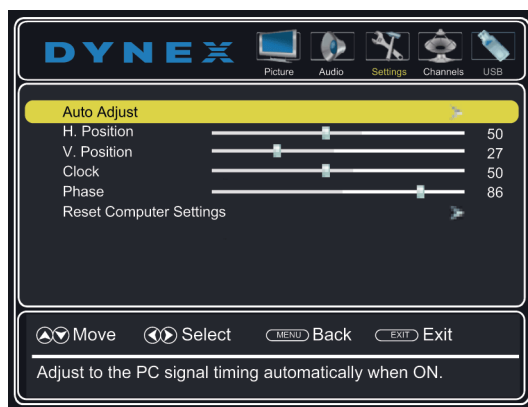

- 4 Press **▲** or **▼** to highlight an option, then press **ENTER** to access the option. You can select:
 - **Auto Adjust**—Automatically adjusts the image settings such as position and phase.
 - **H. Position**—Moves the image right or left.
 - **V. Position**—Moves the image up or down.
 - **Clock**—Minimizes vertical stripes in the screen image.
 - **Phase**—Adjusts the focus of stable images.
 - **Reset Computer Settings**—Resets all computer settings to factory default.
- 5 Press **◀** or **▶** to adjust the option, or press **▲** or **▼** to select a setting.
- 6 Press **MENU** to return to the previous menu, or press **EXIT** to close the menu.

Adjusting the sound

Adjusting sound settings

- 1 Press **MENU**. The on-screen menu opens.
- 2 Press **◀** or **▶** to highlight **Audio**, then press **▼**. The *Audio* menu opens.

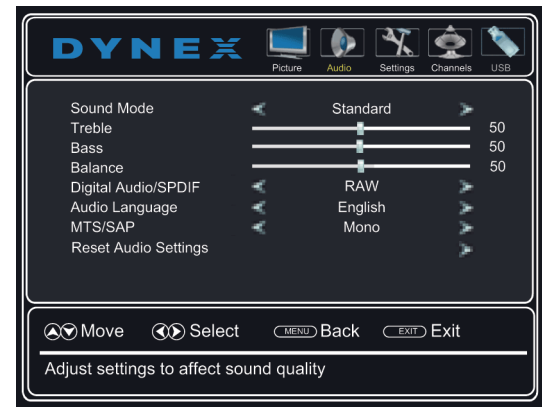

- 3 Press **▲** or **▼** to highlight an option, then press **◀** or **▶** to adjust the option. You can select:

- **Sound Mode**—Selects the sound mode. You can select:
 - **Standard**—Balances treble and bass. This setting is good for watching standard TV broadcasts.
 - **Theater**—Enhances treble and bass for a rich sound experience. This setting is good for watching DVDs, Blu-ray discs, and HDTV.
 - **Music**—Preserves the original sound. This setting is good for listening to music.
 - **News**—Enhances vocals for TV audio. This setting is good for watching news broadcasts.
 - **Custom**—Lets you manually adjust sound settings.
- **Treble**—Adjusts the high sounds.
- **Bass**—Adjusts the low sounds.
- **Balance**—Adjusts the balance between the left and right audio channels.
- **Digital Audio/SPDIF**—Sends digital audio to an external audio system. You can select **PCM** (to output audio in 2-channel stereo), or **RAW** (to pass through the original digital audio sound).
- **Audio Language**—(Digital channels only) Selects an alternate audio language, if available.

- **MTS/SAP**—(Analog channels only) Selects the audio mode. You can select:
 - **Mono**—Select this option if there is noise or static on weak stereo broadcasts.
 - **Stereo**—Select this option for programs broadcast in stereo.
 - **SAP**—Select this option to listen to a secondary audio program, if available.

Note

You can also press **MTS/SAP** one or more times to select the audio mode.

- **Reset Audio Settings**—Reset all audio settings to factory defaults.
- 4 Press **MENU** to return to the previous menu, or press **EXIT** to close the menu.

Playing TV audio only

You can turn off the picture on your TV and listen to the program audio only.

- 1 Press **MENU**. The on-screen menu opens.
- 2 Press **◀** or **▶** to highlight **Audio**, then press **▼** or **ENTER**. The *Channels* menu opens.



- 3 Press **▲** or **▼** to highlight **Audio Only**, then press **◀** or **▶** to select **On**.
- 4 Press **MENU** to return to the previous menu, or press **EXIT** to close the menu.

Notes

- The picture turns off in about five seconds.
- **Audio Only** works only when the input source is TV, and your TV is receiving a broadcast signal.
- To exit audio only mode, press any button. When you exit audio only mode, the **Audio Only** option is automatically reset to **Off**.

Setting parental controls

Parental controls let you prevent your children from watching inappropriate material on TV. When set, parental controls read the rating of the program (with some exceptions, such as news and sports) and deny access to programs that exceed the ratings level you select. To watch programs that exceed the selected rating, you must enter the password.

Setting or changing the password

- 1 Press **MENU**. The on-screen menu opens.
- 2 Press **◀** or **▶** to highlight **Settings**, then press **▼**. The *Settings* menu opens with **Parental Controls** highlighted.



- 3 Press **ENTER**. The *Enter Password* screen opens.

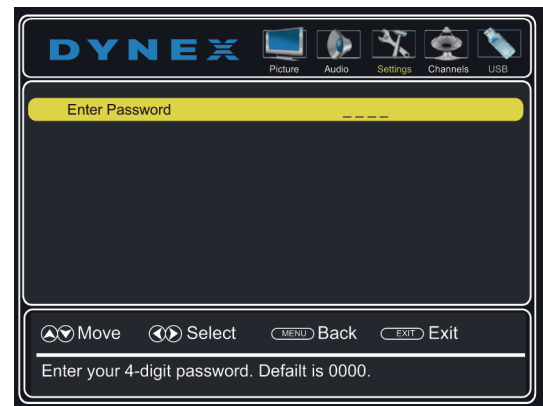

- Press the number buttons to enter the four-digit password. The default password is **0000**. You should change the password to something you can remember. The parental controls menu opens.

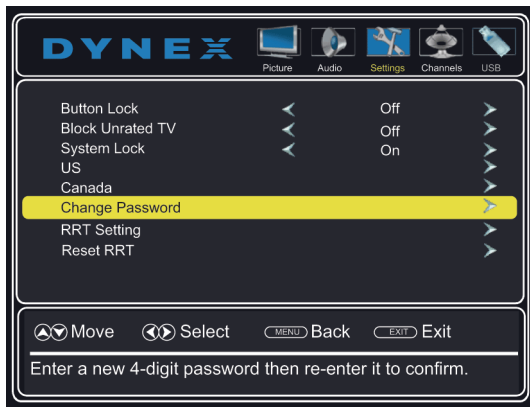

- Press **▲** or **▼** to highlight **Change Password**, then press **ENTER**. The password entry screen opens.

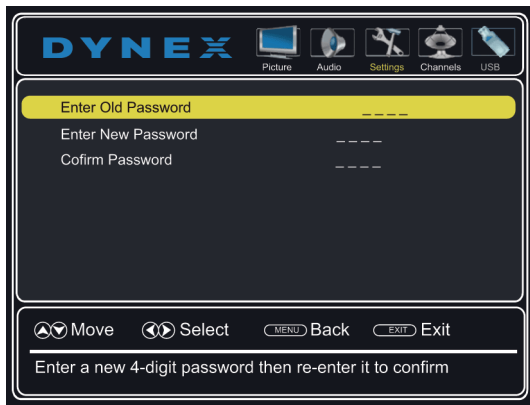

- Press the number buttons to enter the old password, enter a new password, then enter the new password again. The password has been successfully changed.

Note
If you forget your password, enter **9999**.

- Press **MENU** to return to the previous menu, or press **EXIT** to close the menu.

Locking control buttons

When the button lock is turned **On**, the buttons on the side of your TV are locked, and you can only operate your TV using the remote control.

- Press **MENU**. The on-screen menu opens.
- Press **◀** or **▶** to highlight **Settings**, then press **▼**. The **Settings** menu opens with **Parental Controls** highlighted.

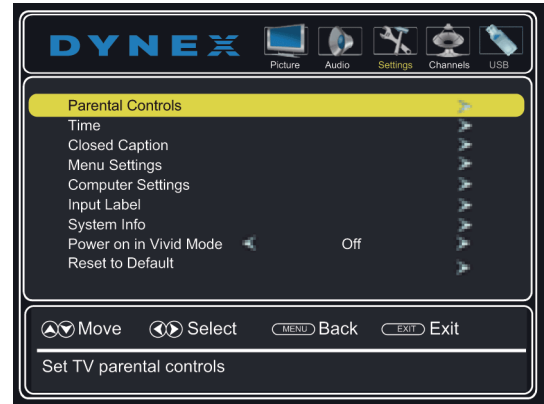

- Press **ENTER**. The *Enter Password* screen opens.

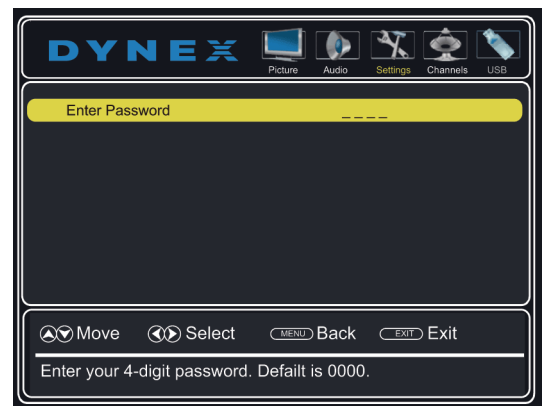

- Press the number buttons to enter the four-digit password. The parental controls menu opens with **Button Lock** highlighted.



- Press **ENTER**.

- Press ◀ or ▶ to select **On** (locks the buttons) or **Off** (unlocks the buttons).
- Press **MENU** to return to the previous menu, or press **EXIT** to close the menu.

Setting the system lock

You must turn on the system lock before you can select and change the **Block Unrated TV, US, or Canada** options.

- Press **MENU**. The on-screen menu opens.
- Press ◀ or ▶ to highlight **Settings**, then press ▼. The **Settings** menu opens with **Parental Controls** highlighted.



- Press **ENTER**. The *Enter Password* screen opens.

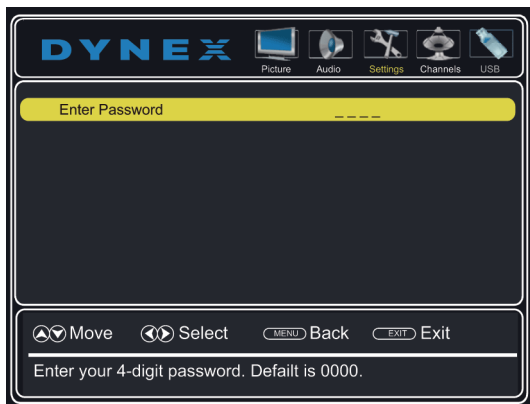

- Press the number buttons to enter the four-digit password. The parental controls menu opens.

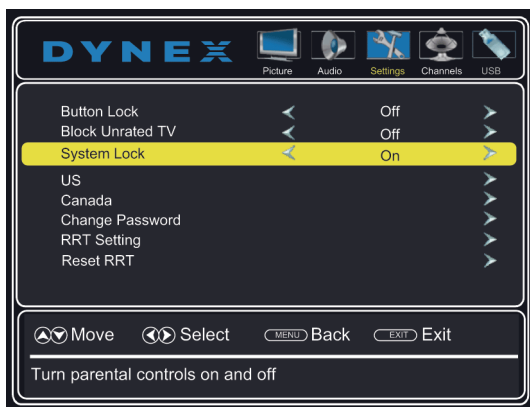

- Press ▼ to highlight **System Lock**.
- Press ◀ or ▶ to select **On** (turns on parental controls) or **Off** (turns off parental controls).
- Press **MENU** to return to the previous menu, or press **EXIT** to close the menu.

Blocking unrated TV

When Block Unrated TV is turned on, you block TV programs that do not have a rating. You will be prompted to enter the parental controls password to view the program.

- Press **MENU**. The on-screen menu opens.
- Press ◀ or ▶ to highlight **Settings**, then press ▼. The **Settings** menu opens with **Parental Controls** highlighted.



- Press **ENTER**. The *Enter Password* screen opens.

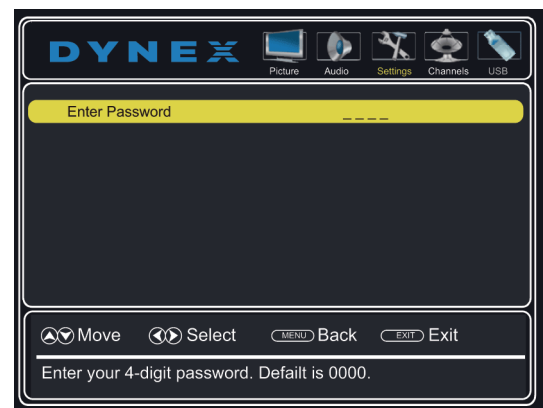

- Press the number buttons to enter the four-digit password. The parental controls menu opens.

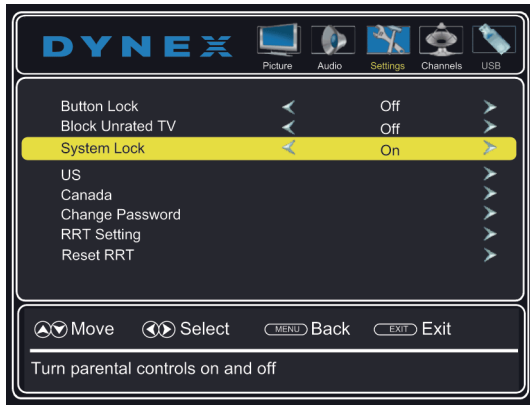

- Press **▼** to highlight **System Lock**, then press **◀** or **▶** to select **On**.
- Press **▲** to highlight **Block Unrated TV**.
- Press **◀** or **▶** to select **On** (blocks unrated TV) or **Off** (does not block unrated TV).
- Press **MENU** to return to the previous menu, or press **EXIT** to close the menu.

Setting parental control levels

You can set parental control levels for the U.S. and Canada. Parental control settings are only applicable to programs that have a rating signal.

U.S. rating levels

U.S. TV ratings	
NONE	Not rated
TV-Y	All children
TV-Y7	Suitable for children 7 and older
TV-G	General audiences
TV-PG	Parental guidance suggested
TV-14	Parental guidance strongly suggested
TV-MA	Mature audiences only

Some of the age-based TV Parental Guidelines ratings also have content-based ratings.

U.S. TV content ratings	
All	All ratings are blocked
FV	Fantasy violence
L	Strong language
S	Sexual situations
V	Violence
D	Suggestive dialog

U.S. movie (MPAA) ratings

None	Movie not rated
G	General audiences
PG	Parental guidance suggested
PG-13	Suitable for children 13 and older
R	Parental guidance suggested for children under 17
NC-17	Not suitable for children under 17
X	Adults only

Canadian rating levels

Canadian English ratings

E	Exempt programming
C	Suitable for all children
C8+	Suitable for children 8 and older
G	General audiences
PG	Parental guidance suggested
14+	Suitable for children 14 and older
18+	Adult only

Canadian French ratings

E	Exempt programming
G	General audiences
8ans+	Suitable for children 8 and older
13ans+	Suitable for children 13 and older
16ans+	Suitable for children 16 and older
18ans+	Adult only

- Press **MENU**. The on-screen menu opens.
- Press **◀** or **▶** to highlight **Settings**, then press **▼**. The **Settings** menu opens with **Parental Controls** highlighted.



- 3 Press **ENTER**. The *Enter Password* screen opens.

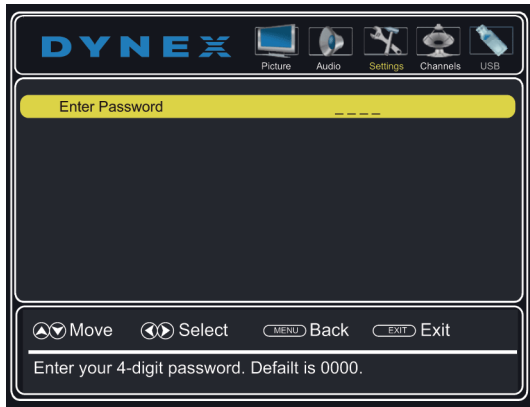

- 4 Press the number buttons to enter the four-digit password. The parental controls menu opens.

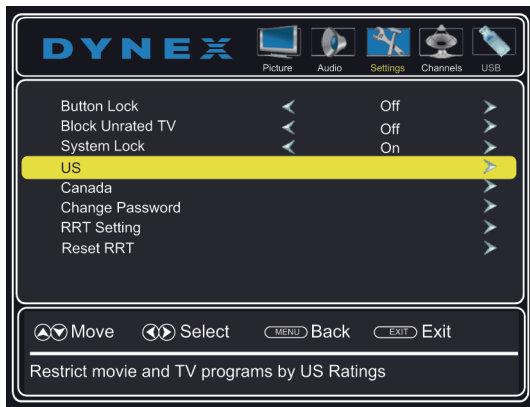

- 5 Press **▲** or **▼** to highlight **US** (or **Canada** to set controls for Canada), then press **ENTER**. The ratings screen opens.

US ratings

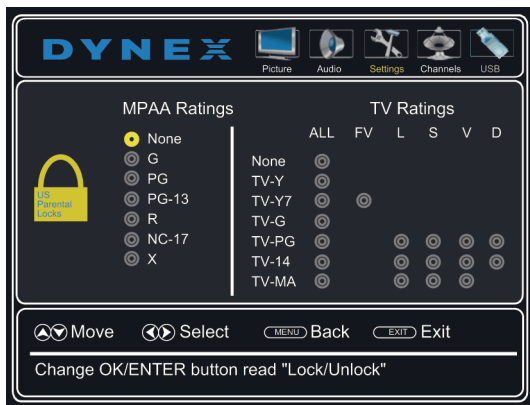

Canadian ratings

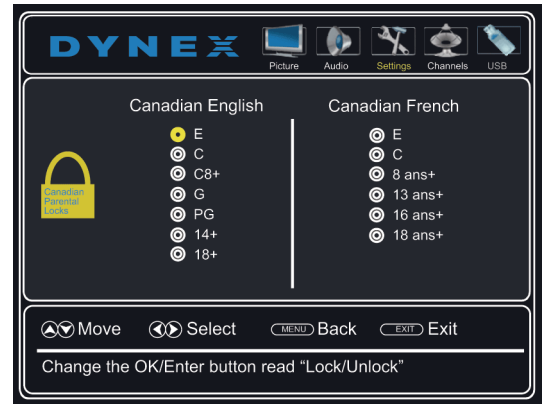

- 6 Press **▲ ▼ ◀ ▶** to highlight the rating you want to block, then press **ENTER**. A lock symbol appears when a rating is blocked.

Note
When you block a rating, that rating and all higher ratings are blocked.

- 7 Press **EXIT** to close the menu.

Downloading rating information

- 1 Press **MENU**. The on-screen menu opens.
2 Press **◀ ▶** to highlight **Settings**, then press **▼**. The *Settings* menu opens with **Parental Controls** highlighted.

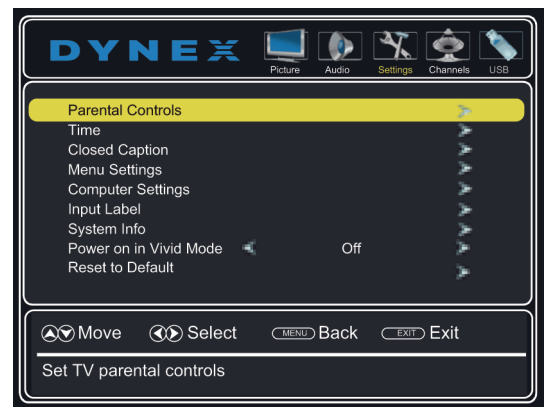

- 3 Press **ENTER**. The *Enter Password* screen opens.

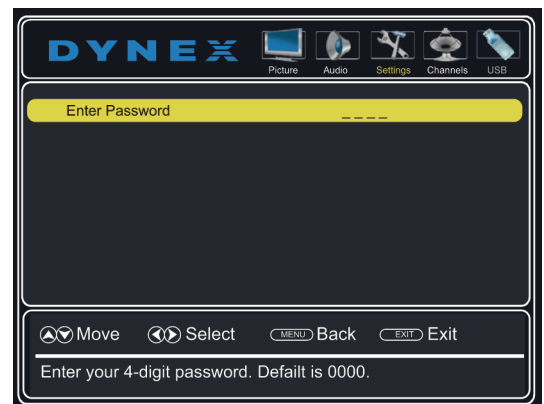

- Press the number buttons to enter the four-digit password. The parental controls menu opens.

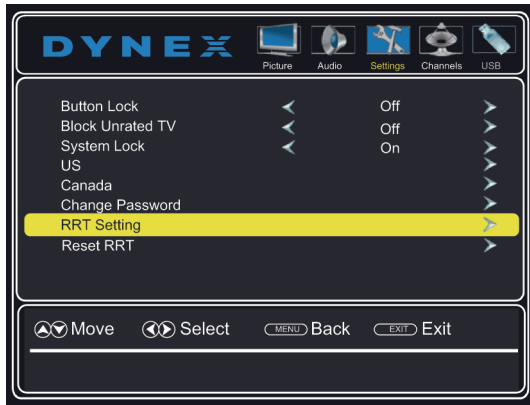

- Press **▲** or **▼** to highlight **RRT Setting**, then press **ENTER**.
If the program is broadcast with RRT rating information, the information is downloaded automatically and can be used for parental controls.
- To reset the RRT information to the factory default, press **▲** or **▼** to highlight **Reset RRT**, then press **ENTER**. A box opens. Follow the on-screen instructions.
- Press **EXIT** to close the menu.

Adjusting time settings

Setting the clock

- Press **MENU**. The on-screen menu opens.
- Press **◀** or **▶** to highlight **Settings**, then press **▼**. The **Settings** menu opens.



- Press **▲** or **▼** to highlight **Time**, then press **ENTER**. The time menu opens.



- Press **▲** or **▼** to highlight **Style**, then press **◀** or **▶** to select **Manual** (to set the date and time manually), or **Auto** (to have the date and time set automatically from a TV source signal, based on your time zone).

Note

If you select **Auto**, the displayed time is incorrect until your TV gets the correct time from a TV signal source.

- If you selected **Auto** for **Style**, press **▲** or **▼** to highlight **Time Zone**, then press **◀** or **▶** to select your time zone. You can select **Atlantic, Eastern, Central, Mountain, Pacific, Alaska, Hawaii, or Newfoundland**.
- If your viewing area observes daylight savings time, press **▲** or **▼** to highlight **Daylight Savings**, then press **◀** or **▶** to select **On** or **Off**.
- If you selected **Manual** for **Style**:
 - Press **▲** or **▼** to highlight **Year, Month, or Day**, then press **◀** or **▶** to adjust the setting.
 - Press **▲** or **▼** to highlight **Time**, press **◀** or **▶** to highlight the hour, minute, or AM/PM field, then press **▲** or **▼** to adjust the setting.
- Press **EXIT** to close the menu.

Setting the sleep timer

You can set the amount of time before your TV automatically turns off.

- 1 Press **MENU**. The on-screen menu opens.
- 2 Press **◀** or **▶** to highlight **Settings**, then press **▼**. The **Settings** menu opens.

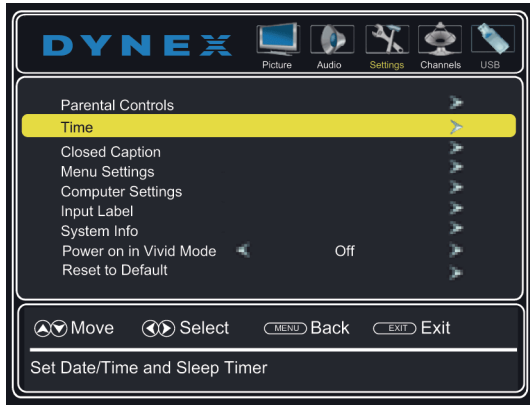

- 3 Press **▲** or **▼** to highlight **Time**, then press **▶** or **ENTER**. The time menu opens.

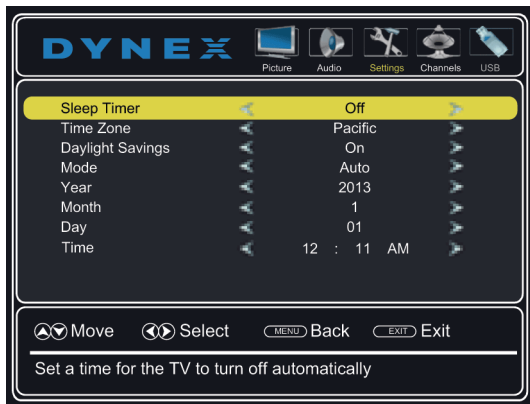

- 4 Press **▲** or **▼** to highlight **Sleep Timer**, then press **◀** or **▶** to select the amount of time before your TV turns off automatically. You can select **Off**, **5**, **10**, **15**, **30**, **60**, **90**, **120**, **180**, or **240** minutes.
- 5 To turn off the sleep timer, select **Off**.
- 6 Press **EXIT** to close the menu.

Note

You can also press **SLEEP** to set the sleep timer.

Using closed captioning

Closed captioning displays a text version of the TV program audio or displays information provided by the broadcaster.

Turning closed captioning on or off

- 1 Press **MENU**. The on-screen menu opens.
- 2 Press **◀** or **▶** to highlight **Settings**, then press **▼**. The **Settings** menu opens.

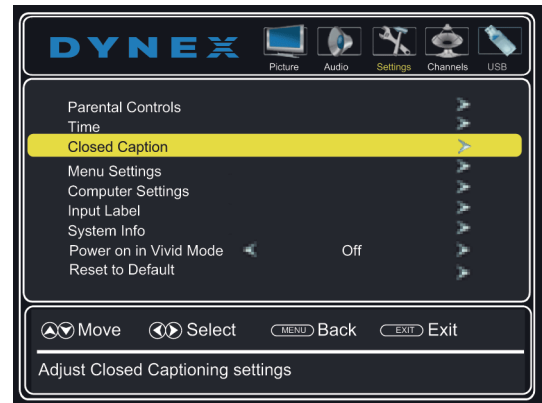

- 3 Press **▲** or **▼** to highlight **Closed Caption**, then press **ENTER**. The closed caption menu opens.

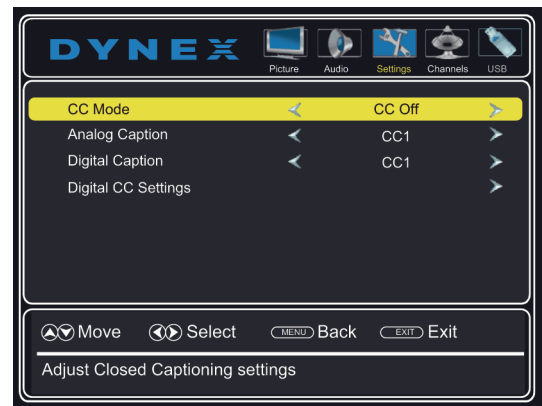

- 4 Press **▲** or **▼** to highlight **CC Mode**, then press **◀** or **▶** to select **CC Off** (turns off closed captioning), **CC On** (turns on closed captioning), or **CC On When Mute** (turns on closed captioning when the sound is muted).
- 5 Press **MENU** to return to the previous menu, or press **EXIT** to close the menu.

Note

You can also press **CCD** to turn closed captioning on or off.

Selecting the analog closed captioning mode

Analog channels usually have one or more closed captioning modes. The CC1 mode usually displays a text version of the TV program audio in a small banner. The other CC modes display information provided by the broadcaster. The Text modes display information in a box that covers half of the screen.

- 1 Press **MENU**. The on-screen menu opens.
- 2 Press **◀** or **▶** to highlight **Settings**, then press **▼**. The **Settings** menu opens.

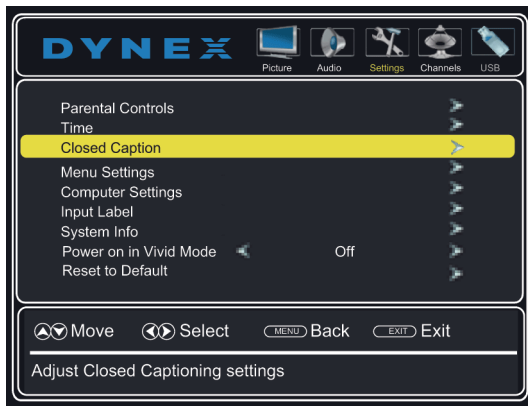

- 3 Press **▲** or **▼** to highlight **Closed Caption**, then press **ENTER**. The closed caption menu opens.

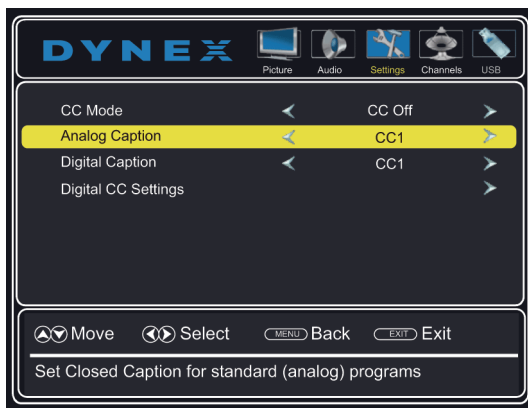

- 4 Press **▲** or **▼** to highlight **Analog Caption**, then press **◀** or **▶** to select an analog caption setting. You can select:
 - **CC1** through **CC4**—Closed captioning appears in a small banner across the bottom of the screen. **CC1** is usually the "printed" version of the audio. **CC2** through **CC4** display content provided by the broadcaster.
 - **Text1** through **Text4**—Closed captioning covers half or all of the screen. **Text1** through **Text4** display content provided by the broadcaster.

Selecting the digital closed captioning mode

Digital channels usually have one or more closed captioning modes. The CC1 mode usually displays a text version of the TV program audio in a small banner. The other CC modes display information provided by the broadcaster. CS1 mode displays a text version of the audio in the same language as the audio.

- 1 Press **MENU**. The on-screen menu opens.
- 2 Press **◀** or **▶** to highlight **Settings**, then press **▼**. The **Settings** menu opens.

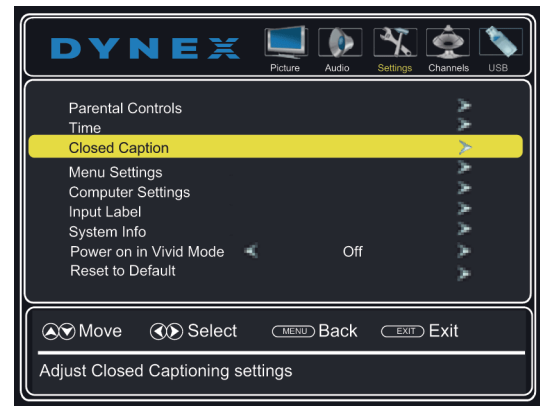

- 3 Press **▲** or **▼** to highlight **Closed Caption**, then press **ENTER**. The closed caption menu opens.

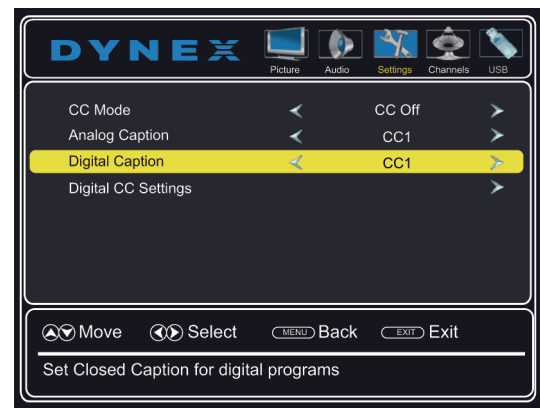

- 4 Press **▲** or **▼** to highlight **Digital Caption**, then press **◀** or **▶** to select a digital caption setting. You can select:
 - **CS1** through **CS6**—CS1 is usually the "printed" version of the audio. CS2 through CS6 display content provided by the broadcaster. You can change the way digital closed captioning is displayed on the screen. For more information, see "[Customizing digital closed captioning styles](#)" on page 54.
 - **CC1** through **CC4**—Closed captioning appears in a small banner across the bottom of the screen. **CC1** is usually the "printed" version of the audio. **CC2** through **CC4** display content provided by the broadcaster.
- 5 Press **EXIT** to close the menu.

Customizing digital closed captioning styles

- 1 Press **MENU**. The on-screen menu opens.
- 2 Press **◀** or **▶** to highlight **Settings**, then press **▼**. The **Settings** menu opens.

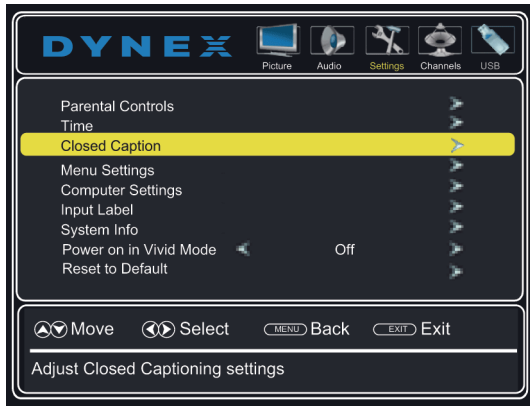

- 3 Press **▲** or **▼** to highlight **Closed Caption**, then press **ENTER**. The closed caption menu opens.
- 4 Make sure that **Digital Caption** is turned on. For more information, see "Selecting the digital closed captioning mode" on page 53.
- 5 Press **▲** or **▼** to highlight **Digital CC Settings**.

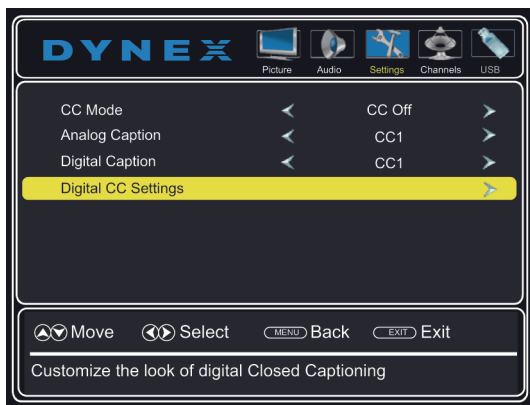

- 6 Press **ENTER**. The digital CC settings menu opens.

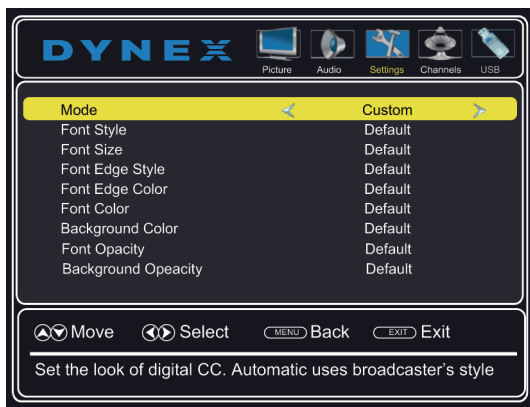

- 7 Press **▲** or **▼** to select **Mode**, then press **◀** or **▶** to select **Custom**.

Note

To reset the closed caption styles to their defaults, set **Mode** to **Default**.

- 8 Press **▲** or **▼** to highlight an option, then press **◀** or **▶** to adjust the style. You can select:
 - **Font Style**—Selects the font style.
 - **Font Size**—Selects the font size.
 - **Font Edge Style**—Selects the style of the window edge.
 - **Font Edge Color**—Selects the color of the window edge.
 - **Font Color**—Selects the color for the words.
 - **Background Color**—Selects the color for the background.
 - **Font Opacity**—Selects the opacity level for the words.
 - **Background Opacity**—Selects the opacity level for the background.
- 9 Press **EXIT** to close the menu.

Adjusting menu settings

Selecting the menu language

- 1 Press **MENU**. The on-screen menu opens.
- 2 Press **◀** or **▶** to highlight **Settings**, then press **▼**. The **Settings** menu opens.

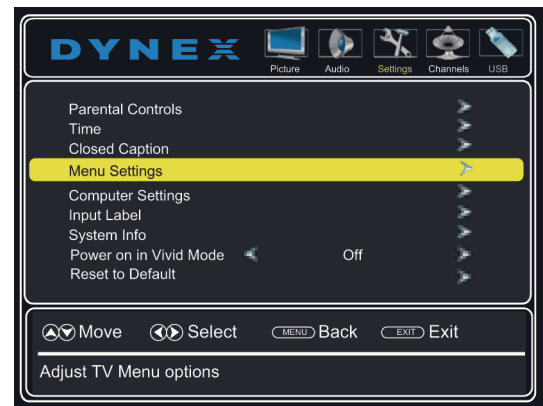

- 3 Press **▲** or **▼** to highlight **Menu Settings**, then press **▶** or **ENTER**. A menu opens with **Menu Language** highlighted.
- 4 Press **◀** or **▶** to select the menu language. You can select **English**, **Français**, or **Español**.
- 5 Press **EXIT** to close the menu.

Labeling an input source

You can add a label to a video input source to make it easier to identify. These labels are displayed on the *INPUT SOURCE* list and on the banner that appears when you press **INFO**.

- 1 Press **MENU**. The on-screen menu opens.
- 2 Press **◀** or **▶** to highlight **Settings**, then press **▼**. The *Settings* menu opens.

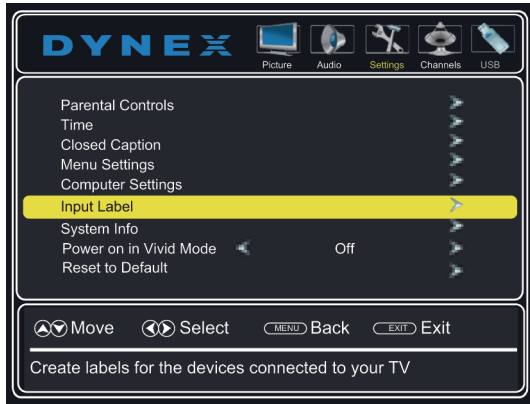

- 3 Press **▲** or **▼** to highlight **Input Label**, then press **ENTER**. A menu opens with **Preset Label** highlighted.



- 4 Press **◀** or **▶** to select a preset label from several options, or select **Custom** to enter your own label.

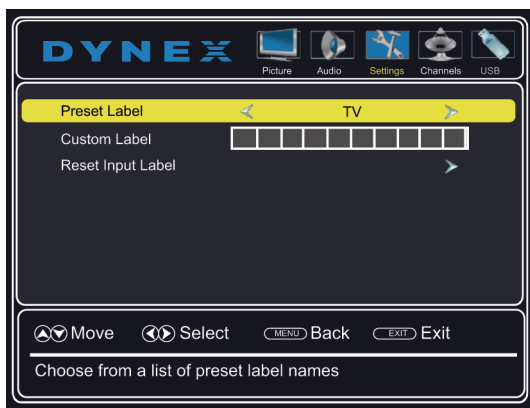

- 5 If you select **Custom**, press **▲** or **▼** to highlight **Custom Label**, then press **▶**.

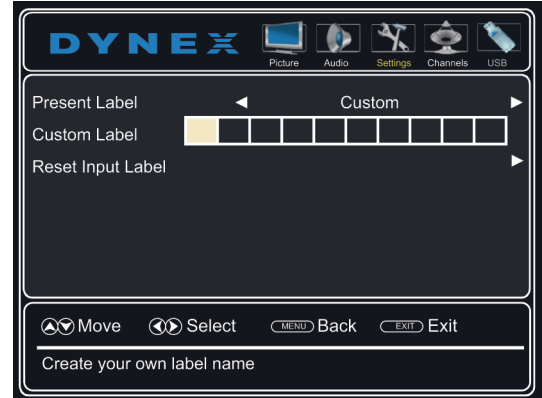

- 6 Press **▲** or **▼** to select a character.
- 7 Press **▶** to move to the next position. Repeat this step to enter additional characters. You can enter as many as 10 characters. If you need to delete a character, enter a blank space.
- 8 When you complete the label, press **MENU**. The next time you press **INPUT**, the new label appears in the *INPUT SOURCE* list.
- 9 Press **EXIT** to close the menu.

Changing channel settings

Automatically scanning for channels

When you scan for channels, your TV searches for channels with signals and stores the channel information in the channel list. When you press **CH+** or **CH-**, your TV goes to the next or previous channel in the channel list.

If the TV signal source changes, for example you change from an outdoor antenna to cable TV (no box), you need to scan for channels.

- 1 Press **MENU**. The on-screen menu opens.
- 2 Press **◀** or **▶** to highlight **Channels**, then press **▼** or **ENTER**. The *Channels* menu opens.



- 3 Press **▲** or **▼** to highlight **Auto Channel Scan**, then press **ENTER**. The *Choose Your TV Source* screen opens.

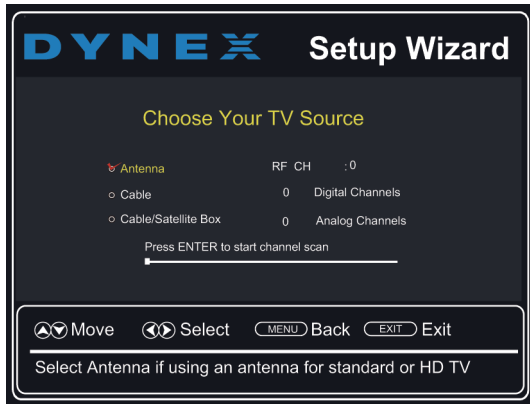

- 4 Press **▲** or **▼** to highlight **Antenna**, **Cable**, or **Cable/Satellite Box**, then press **ENTER**.
- If you are using an antenna for a standard or HD TV signal, select **Antenna**. Your TV scans for available channels. The scan may take several minutes. During scanning your TV searches for digital channels first. When the digital channel search is complete, a message appears asking if you want to search for analog channels. Select **Yes** to continue searching for analog channels, or select **No** to stop searching for channels.
 - If your cable is connected directly to the TV (without a box), select **Cable**. Your TV scans for available channels. The scan may take several minutes.
 - If your cable or satellite TV is connected to your TV through a box, select **Cable/Satellite Box**. Your TV does not need to scan for channels. A message tells you to select the correct input source. Press **INPUT**, press **▲** or **▼** to highlight the video input you connected your TV to, then press **ENTER**.

Note

You can press **EXIT** to stop the auto channel search, but you will need to run the auto channel search again to create a channel list.

Hiding channels

You can hide channels in the channel list. When you press **CH+** or **CH-**, your TV skips the hidden channels. You can still tune to a hidden channel by pressing the number buttons for the channel.

- 1 Press **MENU**. The on-screen menu opens.
- 2 Press **◀** or **▶** to highlight **Channels**, then press **▼**. The *Channels* menu opens.



- 3 Press **▲** or **▼** to highlight **Add/Skip Channels**, then press **ENTER**. The channel list opens.

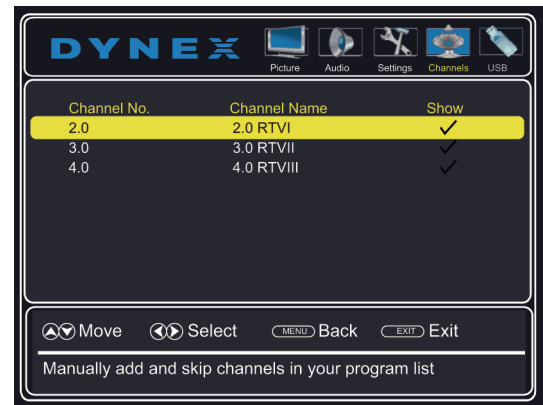

- 4 Press **▲** or **▼** to highlight the channel you want to hide, then press **ENTER**. The check mark disappears.

Notes

- When you highlight a channel in the list, your TV displays the channel in the background.
- A channel with a check mark is not hidden. A channel with no check mark is hidden.
- If the list has more than one page, press **▲** or **▼** to scroll through the pages.

- 5 Press **MENU** to return to the previous menu, or press **EXIT** to close the menu.

Setting up a favorite channel list

You can create a favorite channel list so you can quickly browse through your favorite channels by pressing **FAV**, then selecting a channel from the favorite channel list.

- 1 Press **MENU**. The on-screen menu opens.
- 2 Press **◀** or **▶** to highlight **Channels**, then press **▼** or **ENTER**. The *Channels* menu opens.

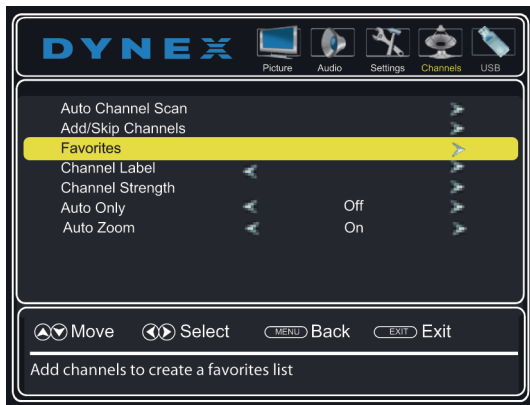

- 3 Press **▲** or **▼** to highlight **Favorites**, then press **ENTER**. The favorites list opens.

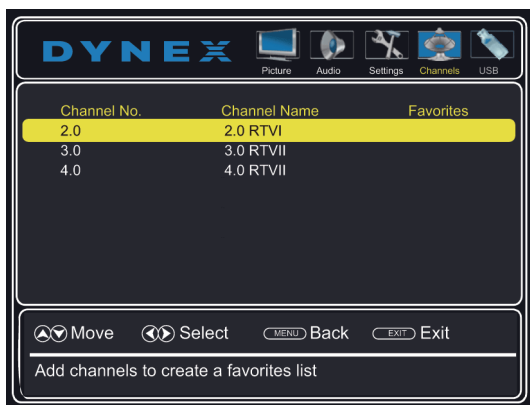

- 4 Press **▲** or **▼** to highlight the channel you want to add to the favorites list, then press **ENTER**. A check mark appears next to the channel.

Notes

- When you highlight a channel in the list, your TV displays the channel in the background.
- To remove a channel from the favorites list, highlight the channel, then press **ENTER**. The check mark disappears and the channel is removed from the list.
- If the list has more than one page, press **▲** or **▼** to scroll through the pages.

- 5 Press **MENU** to return to the previous menu, or press **EXIT** to close the menu.

Viewing a favorite channel

- 1 Press **FAV** on your remote control. The *Favorites* channel list opens.
- 2 Press **▲** or **▼** to highlight a channel, then press **ENTER** to tune to the channel.

Adding or changing a channel label

If a channel is not already labeled, you can label the channel to make it easier to identify. You can also relabel a channel that is already labeled.

- 1 Press **MENU**. The on-screen menu opens.
- 2 Press **◀** or **▶** to highlight **Channels**, then press **▼** or **ENTER**. The *Channels* menu opens.



- 3 Press **▲** or **▼** to highlight **Channel Label**, then press **ENTER**. The channel label screen opens.
- 4 Press **▲** or **▼** to select the channel you want to label.

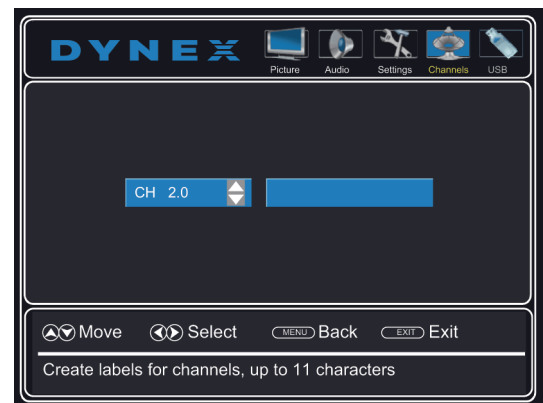

- 5 Press **▶** to move to the channel label field.

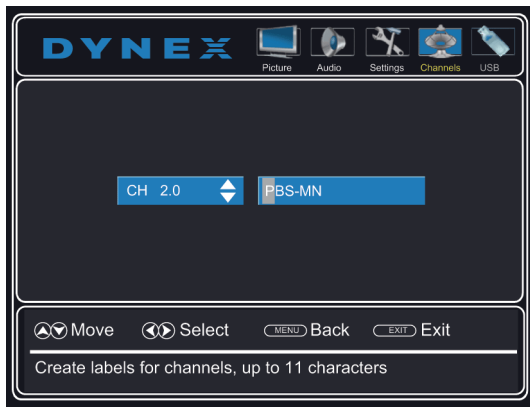

- 6 Press **▲** or **▼** to select a character, then press **◀** or **▶** to move to the previous or next position. Repeat this step to add more characters. You can enter as many as 11 characters. If you need to delete a character, enter a blank space, then press **ENTER**.
- 7 When you have completed the label, press **ENTER**.
- 8 Press **EXIT** to close the menu.

Checking the digital signal strength

You can check the digital signal strength to determine if you need to adjust your antenna or digital cable input. The higher the signal strength, the less likely you are to experience picture degradation.

- 1 Press **MENU**. The on-screen menu opens.
- 2 Press **◀** or **▶** to highlight **Channels**, then press **▼** or **ENTER**. The *Channels* menu opens.



- 3 Press **▲** or **▼** to highlight **Channel Strength**, then press **ENTER**. The DTV signal strength is indicated by the color bar.

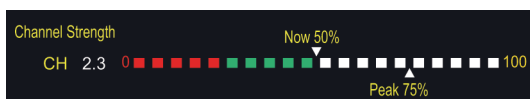

- 4 Press **MENU** to return to the previous menu, or press **EXIT** to close the menu.

Maintaining

- Do not use your TV in areas that are too hot or too cold, because the cabinet may warp or the screen may malfunction. Your TV works best in temperatures that are comfortable to you.
- Storage temperatures are 32° to 122°F (0° to 50°C).
- Working temperatures are 41° to 104°F (5° to 40°C).
- Do not place your TV in direct sunlight or near a heat source.

Cleaning your TV

- Before cleaning the screen, unplug your TV from the power outlet.
- Clean your TV with a soft, lint-free cloth. If surfaces are extremely dirty, use a soft cloth dampened with a weak detergent solution.
- Use an eyeglass cleaner to clean the screen. Never use alcohol, paint thinner, or benzine.
- Before using a chemically treated cloth, read the instructions that came with the cloth.
- Do not spray insecticide liquid near your TV. Such chemicals may cause damage and discoloration to the exposed surfaces.

Troubleshooting

Warning

Do not try to repair your TV yourself.
Contact authorized service personnel.

Restoring settings to default

Caution

When you restore default settings, all the settings you have customized are reset.

- 1 Press **MENU**. The on-screen menu opens.
- 2 Press **◀** or **▶** to highlight **Settings**, then press **▼**. The **Settings** menu opens.

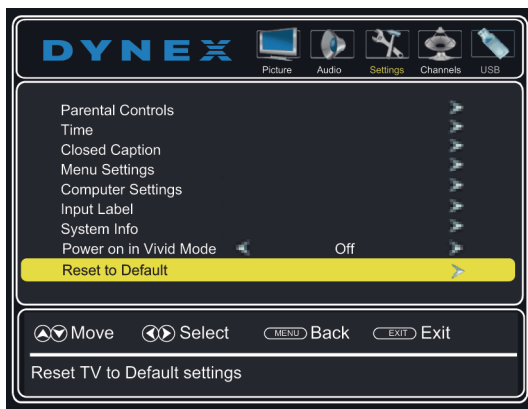

- 3 Press **▲** or **▼** to highlight **Reset to Default**, then press **ENTER**. A confirmation box opens.
- 4 Press **◀** or **▶** to select **Yes** (to reset all settings to factory default), or **No** (to not reset). If you select **Yes**, your TV turns off, then turns on again. The **SETUP Wizard** opens.
- 5 Go through the **TV SETUP** wizard. For more information, see "Turning on your TV for the first time" on page 34.

Viewing system information

You may need to view system information during troubleshooting.

- 1 Press **MENU**. The on-screen menu opens.
- 2 Press **◀** or **▶** to highlight **Settings**, then press **▼** or **ENTER**. The **Settings** menu opens.

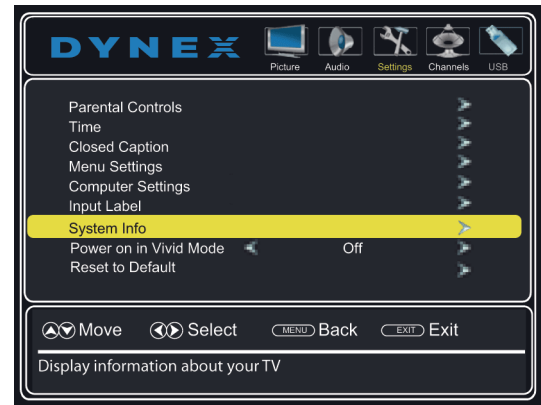

- 3 Press **▲** or **▼** to highlight **System Info**, then press **ENTER**. Information about the TV software version is displayed.
- 4 Press **MENU** to return to the previous menu, or press **EXIT** to close the menu.

Video and audio

Problem	Solution
Picture does not fill the screen. There are black bars around the picture.	<ul style="list-style-type: none"> Change the aspect ratio. An increasing amount of digital TV and movies are presented in wide screen (16:9). See “Adjusting the TV picture” on page 43.
No picture (screen is not lit) and no sound.	<ul style="list-style-type: none"> Press ⏻ (power) on the TV or the remote control. Make sure that the video cables are connected securely to the side or back of your TV. Adjust the contrast and brightness. See “Adjusting the TV picture” on page 43. Make sure that the power cord is plugged into a working outlet. Make sure that the correct video input source is selected. See “Selecting the video input source” on page 36. Try another channel. The station may be experiencing problems. Make sure that the incoming signal is compatible. Make sure that the antenna or cable TV is connected correctly and securely. See “Connecting a cable or satellite box” on page 13 or “Connecting an antenna or cable TV (no box)” on page 18. Check the closed caption settings. Some TEXT modes can block the screen.
Picture quality is good on some channels and poor on others. Sound is good.	<ul style="list-style-type: none"> The problem may be caused by a poor or weak signal from the broadcaster or cable TV provider. If you connect to cable or satellite TV without a set-top box and experience poor picture quality, you may need to install a set-top box to improve signal reception and picture quality. Contact your cable or satellite TV provider about upgrading to a set-top box.

Problem	Solution
Dark, poor, or no picture (screen is lit), but sound is good.	<ul style="list-style-type: none"> Try another channel. The station may be experiencing problems. Make sure that the antenna or cable TV is connected correctly and securely. See “Connecting a cable or satellite box” on page 13 or “Connecting an antenna or cable TV (no box)” on page 18. Adjust the brightness. See “Adjusting the TV picture” on page 43. Make sure that the correct picture mode is selected. See “Adjusting the TV picture” on page 43. If you are using an antenna, the digital channel signal may be low. To check the digital channel signal strength, see “Checking the digital signal strength” on page 58. If you are using an antenna and the signal strength is low, adjust the antenna or use a highly directional outdoor antenna or set-top antenna with a built-in amplifier. Make sure that the video cables are connected securely to the side or back of your TV. The video cable(s) you are using may be bad. Try a new set.
No color, dark picture, or color is not correct.	<ul style="list-style-type: none"> Try another channel. The station may be experiencing problems. Adjust the color saturation. See “Adjusting the TV picture” on page 43. Make sure that the video cables are connected correctly and securely to the side or back of your TV. Make sure that the antenna or cable TV is connected correctly and securely. See “Connecting a cable or satellite box” on page 13 or “Connecting an antenna or cable TV (no box)” on page 18. If you are using an antenna, the digital channel signal may be low. To check the digital channel signal strength, see “Checking the digital signal strength” on page 58. If you are using an antenna and the signal strength is low, adjust the antenna or use a highly directional outdoor antenna or set-top antenna with a built-in amplifier.

Problem	Solution
Only snow (noise) appears on the screen.	<ul style="list-style-type: none"> Try another channel. The station may be experiencing problems. Make sure that the antenna or cable TV is connected correctly and securely. See "Connecting a cable or satellite box" on page 13 or "Connecting an antenna or cable TV (no box)" on page 18. If you are using an antenna, the digital channel signal may be low. To check the digital channel signal strength, see "Checking the digital signal strength" on page 58. If you are using an antenna and the signal strength is low, adjust the antenna or use a highly directional outdoor antenna or set-top antenna with a built-in amplifier.
Dotted lines or stripes appear on the screen.	<ul style="list-style-type: none"> Make sure that the antenna or cable TV is connected correctly and securely. See "Connecting a cable or satellite box" on page 13 or "Connecting an antenna or cable TV (no box)" on page 18. If you are using an antenna, the digital channel signal may be low. To check the digital channel signal strength, see "Checking the digital signal strength" on page 58. If you are using an antenna and the signal strength is low, adjust the antenna or use a highly directional outdoor antenna or set-top antenna with a built-in amplifier. Make sure that the video cables are connected securely to the side or back of your TV. The video cable(s) you are using may be bad. Try a new set. Other devices (for example, surround sound receiver, external speakers, fans, or hair dryers) may be interfering with your TV. Try turning off one device at a time to determine which device is causing interference. After you have determined which device is causing interference, move it further from the TV to eliminate the interference.
Double images.	<ul style="list-style-type: none"> Use a highly directional outdoor antenna, cable TV, or satellite TV.

Problem	Solution
The picture has a few bright or dark spots.	<ul style="list-style-type: none"> A few bright or dark spots on an LCD screen is normal. It does not affect the operation of this TV.
Good picture, but no sound.	<ul style="list-style-type: none"> Increase the volume. Unplug the headphones. Make sure that the sound is not muted. Make sure that the correct audio mode is selected. Make sure that the audio cables are connected correctly and securely to the back of your TV. Make sure that the antenna or cable TV is connected correctly and securely. See "Connecting a cable or satellite box" on page 13 or "Connecting an antenna or cable TV (no box)" on page 18. If you are using an antenna, the digital channel signal may be low. To check the digital channel signal strength, see "Checking the digital signal strength" on page 58. The audio cable(s) you are using may be bad. Try a new set.
Poor picture.	<ul style="list-style-type: none"> Make sure that the room is not too bright. Light reflecting off the screen can make the picture difficult to see. If an S-VHS camera or a camcorder is connected while another connected device is turned on, the picture may be poor. Turn off one or more devices.
Good sound but poor color.	<ul style="list-style-type: none"> Adjust the contrast, color, and brightness settings. See "Adjusting the TV picture" on page 43.
Audio noise.	<ul style="list-style-type: none"> Other devices (for example, surround sound receiver, external speakers, fans, or hair dryers) may be interfering with your TV. Try turning off one device at a time to determine which device is causing interference. After you have determined which device is causing interference, move it further from the TV to eliminate the interference.
No output from one of the speakers.	<ul style="list-style-type: none"> Adjust the audio balance. See "Adjusting sound settings" on page 45. Make sure that the audio cables are connected correctly and securely to the back of your TV.

Problem	Solution
After images appear.	<ul style="list-style-type: none"> Do not display a still image, such as a logo, game, or computer image, for an extended period of time. This can cause a permanent after-image to be burned into the screen. This type of damage is not covered by your warranty.

Remote control

Problem	Solution
Remote control does not work.	<ul style="list-style-type: none"> Make sure that the power cord is plugged into a working outlet. Make sure that there are no obstructions between the remote control and the remote control sensor on the front of the TV. Point the remote control directly at the remote control sensor on your TV. For the location of the remote control sensor, see "Front" on page 8. Make sure that the batteries are installed correctly. See "Installing remote control batteries" on page 34. Replace dead batteries with new batteries. See "Installing remote control batteries" on page 34.
Trouble programming your existing universal remote control.	<ul style="list-style-type: none"> See instructions and a table of common codes in "Programming universal remote controls" on page 65. Codes are subject to change. For up-to-date codes, go to www.dynexproducts.com/remotecodes Replace dead batteries with new batteries. See the <i>User Guide</i> that accompanied the universal remote control. Refer to the <i>User Guide</i> that accompanied your universal remote control and contact the manufacturer if problems persist.

General

Problem	Solution
No power.	<ul style="list-style-type: none"> Make sure that the power cord is plugged into a working outlet. Unplug the power cord, wait 60 seconds, then plug the cord back in and turn on your TV. Other devices (for example, surround sound receiver, external speakers, fans, or hair dryers) may be interfering with your TV. Try turning off one device at a time to determine which device is causing interference. After you have determined which device is causing interference, move it further from the TV to eliminate the interference.
"No signal" error message is displayed.	<ul style="list-style-type: none"> Press INPUT and make sure that you have selected the correct input for the device or service you are trying to use. If you are using a cable or satellite box, use the remote that came with that box to change channels. Make sure that you have the correct input selected to view channels from the cable or satellite box.
After Auto Channel Search, there are no channels.	<ul style="list-style-type: none"> Reception can vary by channel depending on the broadcast power level of a given station. Contact your cable or satellite TV provider. Make sure that the antenna or cable/satellite box is connected securely to your TV. Try replacing the cable between the antenna/cable or cable/satellite box and your TV.
One or more channels do not display.	<ul style="list-style-type: none"> Make sure that the channels are not blocked. See "Setting parental control levels" on page 49. Make sure that the channels are not hidden. The channel may have been deleted from the channel list. You can tune to the channel by pressing the number buttons or you can add the channel back to the channel list. See "Hiding channels" on page 56. If you are using a cable or satellite box, use the remote that came with that box to change channels. Make sure that you have the correct input selected to view channels from the cable or satellite box. If you are using an antenna, the digital channel signal may be low. To check the digital channel signal strength, see "Checking the digital signal strength" on page 58.

Problem	Solution
Password is lost.	<ul style="list-style-type: none"> Enter 9999 to access parental controls, then set a new password. See "Setting or changing the password" on page 46.
Some settings cannot be accessed.	<ul style="list-style-type: none"> If a setting is grayed, the setting is not available in the current video input mode.
TV cabinet creaks.	<ul style="list-style-type: none"> When the TV is in use, the temperature rises naturally and may cause the cabinet to expand or contract which can cause a creaking noise. This is not a malfunction.

Problem	Solution
Control buttons do not work.	<ul style="list-style-type: none"> Make sure that the Button Lock option is set to No. See "Locking control buttons" on page 47. Unplug the power cord, wait a few seconds, then plug the cord back in and turn on your TV.
TV keeps turning off.	<ul style="list-style-type: none"> Make sure that the sleep timer is not turned on. See "Setting the sleep timer" on page 52.

Note
 If the problem is not solved by using these troubleshooting instructions, turn off your TV, then turn it on again.

Specifications

Specifications are subject to change without notice.

Dimensions and weight

Without stand	35.9 × 3.0 × 20.9 in. (91.2 × 7.5 × 53.1 cm) 14.1 lbs. (6.4 kg)
With stand	35.9 × 9.6 × 22.6 in. (91.2 × 24.5 × 57.3 cm) 18.5 lbs. (8.4 kg)

Screen

Screen size measured diagonally	39.5 in.
Display type	LED
Panel 60 Hz vs. 120 Hz	60Hz
Display resolution	1080p
Panel resolution	1920 (H) × 1080 (V)
Aspect ratio	16:9
Contrast ratio (typical)—panel	3,000:1
Dynamic contrast ratio—list value	9,000:1
TV brightness (minimum) cd/m ²	160 nits
Comb filter	3d y/c digital
Response time	8.5 ms
Horizontal viewing angle	176°
Vertical viewing angle	176°

Display resolutions/VGA scan rates

HDMI suggested resolutions	1080p, 1080i, 720p, 480p, 480i
Component video suggested resolutions	1080i, 720p, 480p, 480i
PC/VGA Suggested scan rates:	640 × 480/60Hz, 800 × 600/60Hz, 1024 × 768/60Hz, 1920 × 1080/60Hz

Tuner

Analog	NTSC
Digital	ATSC, 8-VSB, Clear-QAM

Inputs

HDMI	2 (side) E-EDID compliant HDCP compliant
Component video	1 (back)
Composite video	1 (back) Shared with component Y
Shared audio (component and composite)	Yes
PC/VGA	1 (side)
3.5mm PC/DVI audio input	1 (side)
DVI	1 (side) HDMI1 (DVI) jack
USB	1 (side) Supports JPEG and firmware upgrade
Antenna/Cable	1 (side)

Outputs

Video	No
Analog audio/Headphone	1 (back)
Digital audio	1 (coaxial) (back)
WiFi	No
Ethernet	No

Audio

Speakers	Number: 2 Watts per channel: 5W
----------	------------------------------------

Power

Power consumption	On: 75W Standby: <1W
Power input	AC 120 V, 60Hz

Miscellaneous

OSD languages	English, French, Spanish
INlink	No
Game Mode	No
ENERGY STAR qualified	No
Internet connectable	No
TV base screws	Stand column to TV: M4 type (14 mm length) 4pcs TV stand to stand column: ST4 type (12 mm length) 4pcs
V-Chip (version 2.0)	Yes
Sleep timer	Yes
Channel labeling	Yes
VESA mount (mm) (horizontal × vertical)	200 × 200
VESA mount screws	M5 type

Note

The length of the wall-mount screws vary depending on the wall-mount bracket you purchased. See the instructions that came with the wall-mount bracket for screw lengths.

Programming universal remote controls

You can operate your Dynex TV with a new or existing universal remote control.

- 1 See the table below for common codes. If you have problems programming your remote or need a different remote control code, visit www.dynexproducts.com/remotecodes for the latest remote control code information.
- 2 Follow your universal remote control's instructions to enter the TV code you found in Step 1.

Tips	
•	If your universal remote control has a code search feature, run a code search to identify a code that matches your TV. See your universal remote control's instructions for details.
•	If your universal remote control has a "Learn" feature, you can manually program it using the Dynex TV remote to "teach" the commands one at a time. See your universal remote control's instructions for details.

For additional help and information

- Visit <http://www.dynexproducts.com/remotecodes>
- Call technical support for the universal remote control or cable/satellite company of the remote/set-top box you are trying to program.
- Call the Dynex Customer Care Center 1-800-305-2204

Common universal remote control codes

Notes	
•	This note only goes with TV/Blu-ray or TVs.
•	The following codes may not provide full functionality. You may need to use the remote control that came with your TV, especially to control the Blu-ray or DVD functions.

The following is a list of the most common remote control codes. Codes for other remote controls are available online at: www.dynexproducts.com/remotecodes, or check with your cable or satellite TV provider for the remote control code.

Dynex TV codes for universal remote controls (for all Dynex TVs manufactured after Jan. 1, 2007)

Universal remote control makes and models	
One for All	0054
Phillips	0198, 0490
RCA	135
Sony	068, 069, 078, 096, 100, 164, 168, 229, 026

Set-top box makes and models	
Cablevision	068, 069, 078, 096, 100, 164, 168, 229, 026
Charter	2002, 1204, 1423, 1517, 0171, 1963, 0463, 1463, 0842, 1326, 167, 415, 424, 450, 456, 461, 507, 523, 567, 577, 586
Comcast	10171, 11204, 11326, 11463, 11517, 11641, 11780, 11785, 11892, 11963, 12002
Cox	1326, 1463
DirectTV	10171, 11204, 11326, 11517, 11564, 11641, 11963, 12002
Dish Network	720
Time Warner	400, 450, 461, 456, 11463, 1463, 0463
TiVo	0091
Verizon	0198, 0490

Tips	
•	The brand name is often visible on the front of the universal remote control, and the model number is often visible on the back.
•	If your universal remote control isn't listed on the chart, refer to your universal remote control's instructions and try codes for the brands Orion, Emerson, Memorex, Sansui, Sylvania, or Zenith. You may need to try several codes before finding a match.

Legal notices

FCC Statement

This device complies with Part 15 of the FCC Rules. Operation is subject to the following two conditions: (1) this device may not cause harmful interference, and (2) this device must accept any interference received, including interference that may cause undesired operation. This equipment has been tested and found to comply with the limits for a Class B digital device, pursuant to Part 15 of the FCC Rules. These limits are designed to provide reasonable protection against harmful interference in a residential installation. This equipment generates, uses and can radiate radio frequency energy and, if not installed and used in accordance with the instructions, may cause harmful interference to radio communications. However, there is no guarantee that interference will not occur in a particular installation. If this equipment does cause harmful interference to radio or television reception, which can be determined by turning the equipment off and on, the user is encouraged to try to correct the interference by one or more of the following measures:

- Reorient or relocate the receiving antenna.
- Increase the separation between the equipment and receiver.
- Connect the equipment into an outlet on a circuit different from that to which the receiver is connected.
- Consult the dealer or an experienced radio/TV technician for help.

Warning

Changes or modifications not expressly approved by the party responsible for compliance could void the user's authority to operate the equipment.

Cables

Connections to this device must be made with shielded cables with metallic RF/EMI connector hoods to maintain compliance with FCC Rules and Regulations.

Canadian Notice

CAN ICES-3 (B)/NMB-3(B)

Standard Television Receiving Apparatus — Appareil de réception télévision ordinaire, Canada BETS-7 / NTMR-7

IC Statement

This device complies with Industry Canada licence—exempt RSS standard(s).

Operation is subject to the following two conditions: (1) this device may not cause interference, and (2) this device must accept any interference, including interference that may cause undesired operation of the device.

This equipment complies with IC radiation exposure limits set forth for an uncontrolled environment.

HDMI



The terms HDMI and HDMI High-Definition Multimedia Interface, and the HDMI Logo are trademarks or registered trademarks of HDMI Licensing LLC in the United States and other countries.

Dolby Laboratories



Manufactured under license from Dolby Laboratories. Dolby and the double-D symbol are trademarks of Dolby Laboratories.

Open Source

Font name: Arimo

Version 1.23

Copyright 2013 Steve Matteson

Licensed under the Apache License, Version 2.0 (the "License"); you may not use this file except in compliance with the License. You may obtain a copy of the License at

<http://www.apache.org/licenses/LICENSE-2.0>

Unless required by applicable law or agreed to in writing, software distributed under the License is distributed on an "AS IS" BASIS, WITHOUT WARRANTIES OR CONDITIONS OF ANY KIND, either express or implied. See the License for the specific language governing permissions and limitations under the License.

If you require additional information please call the Dynex support line at 1-800-305-2204.

One-year limited warranty - Dynex Televisions

Definitions:

Dynex Products ("Dynex") warrants to you, the original purchaser of this new Dynex-branded television ("Product"), that the Product shall be free of defects in the original manufacturer of the material or workmanship for a period of one (1) year from the date of your purchase of the Product ("Warranty Period"). For this warranty to apply, your Product must be purchased in the United States or Canada from a Best Buy or Future Shop authorized dealer of Dynex brand products only that are packaged with this warranty statement.

How long does the coverage last?

The Warranty Period lasts for 1 year (365 days) from the date you purchased the Product. Your purchase date is printed on the receipt you received with the Product.

What does this warranty cover?

During the Warranty Period, if the original manufacture of the material or workmanship of the Product is determined to be defective by an authorized Dynex repair center or store personnel, Dynex will (at its sole option): (1) repair the Product with new or rebuilt parts; or (2) replace the Product at no charge with new or rebuilt comparable products or parts. Products and parts replaced under this warranty become the property of Dynex and are not returned to you. If service of Products or parts are required after the Warranty Period expires, you must pay all labor and parts charges. This warranty lasts as long as you own your Dynex Product during the Warranty Period. Warranty coverage terminates if you sell or otherwise transfer the Product.

How to obtain warranty service?

If you purchased the Product at a Best Buy or Future Shop retail store location and your television Product has a screen size of less than 42 inches, please take your original receipt and the Product to any Best Buy or Future Shop store. Make sure that you place the Product in its original packaging or packaging that provides the same amount of protection as the original packaging. If you purchased the Product from a Best Buy or Future Shop online web site, mail your original receipt and the Product to the address listed on the web site. Make sure that you put the Product in its original packaging or packaging that provides the same amount of protection as the original packaging.

To obtain in-home warranty service for a television with a screen 42 inches or larger, in the United States call 1-888-BESTBUY, Canada call 1-866-BESTBUY for Future Shop call 1-800-663-2275. Call agents will diagnose and correct the issue over the phone or will have an Dynex-approved repair technician dispatched to your home.

Where is the warranty valid?

This warranty is valid only in the United States and Canada at Best Buy or Future Shop branded retail stores or websites to the original purchaser of the product in the county where the original purchase was made.

What does the warranty not cover?

This warranty does not cover:

- Customer instruction/education
- Installation
- Set up adjustments
- Cosmetic damage
- Damage due to acts of God, such as power surges
- Accident(s)
- Misuse, unintentional or intentional
- Abuse, unintentional or intentional
- Negligence
- Commercial purposes/use, including but not limited to use in a place of business or in communal areas of a multiple dwelling condominium or apartment complex, or otherwise used in a place of other than a private home.
- Modification of any part of the Product, including the antenna
- Plasma display panel damaged by static (non-moving) images applied for lengthy periods (burn-in).
- Damage due to incorrect operation or maintenance
- Connection to an incorrect voltage or power supply
- Outages, static or other problems with over-the-air reception of television broadcast signals.

- Attempted repair by any person not authorized by Dynex to service the Product
- Products sold "as is" or "with all faults"
- Consumables, including but not limited to batteries (i.e. AA, AAA, C etc.)
- Products where the factory applied serial number has been altered or removed
- Loss or Theft of this product or any part of the product
- Failures or Damage caused by any contact including but not limited to liquids, gels or pastes.
- Up to three (3) pixel failures (dots that are dark or incorrectly illuminated) grouped in an area smaller than one tenth (1/10) of the display size or up to five (5) pixel failures throughout the display. (Pixel based displays may contain a limited number of pixels that may not function normally.)
- Problems with delay in motion or action of video images while playing first-person style video games.

REPAIR REPLACEMENT AS PROVIDED UNDER THIS WARRANTY IS YOUR EXCLUSIVE REMEDY FOR BREACH OF WARRANTY. DYNEX SHALL NOT BE LIABLE FOR ANY INCIDENTAL OR CONSEQUENTIAL DAMAGES FOR THE BREACH OF ANY EXPRESS OR IMPLIED WARRANTY ON THIS PRODUCT, INCLUDING, BUT NOT LIMITED TO, LOST DATA, LOSS OF USE OF YOUR PRODUCT, LOST BUSINESS OR LOST PROFITS. DYNEX PRODUCTS MAKES NO OTHER EXPRESS WARRANTIES WITH RESPECT TO THE PRODUCT, ALL EXPRESS AND IMPLIED WARRANTIES FOR THE PRODUCT, INCLUDING, BUT NOT LIMITED TO, ANY IMPLIED WARRANTIES OF AND CONDITIONS OF MERCHANTABILITY AND FITNESS FOR A PARTICULAR PURPOSE, ARE LIMITED IN DURATION TO THE WARRANTY PERIOD SET FORTH ABOVE AND NO WARRANTIES, WHETHER EXPRESS OR IMPLIED, WILL APPLY AFTER THE WARRANTY PERIOD. SOME STATES, PROVINCES AND JURISDICTIONS DO NOT ALLOW LIMITATIONS ON HOW LONG AN IMPLIED WARRANTY LASTS, SO THE ABOVE LIMITATION MAY NOT APPLY TO YOU. THIS WARRANTY GIVES YOU SPECIFIC LEGAL RIGHTS, AND YOU MAY ALSO HAVE OTHER RIGHTS, WHICH VARY FROM STATE TO STATE OR PROVINCE TO PROVINCE.

Contact Dynex:

For customer service please call:

US & Canada 1-800-305-2204

www.dynexproducts.com

DYNEX is a trademark of Best Buy and its affiliated companies.

Registered in some countries.

Distributed by Best Buy Purchasing, LLC

7601 Penn Ave South, Richfield, MN 55423 U.S.A.

©2014 Best Buy. All rights reserved.

Made in China



www.dynexproducts.com
US and Canada Market - (800) 305-2204

DYNEX is a trademark of Best Buy and its affiliated companies.
Registered in some countries.
Distributed by Best Buy Purchasing, LLC
7601 Penn Ave South, Richfield, MN 55423 U.S.A.

©2014 Best Buy. All rights reserved.

Made in China

V1 ENGLISH
14-0572

Free Manuals Download Website

<http://myh66.com>

<http://usermanuals.us>

<http://www.somanuals.com>

<http://www.4manuals.cc>

<http://www.manual-lib.com>

<http://www.404manual.com>

<http://www.luxmanual.com>

<http://aubethermostatmanual.com>

Golf course search by state

<http://golfingnear.com>

Email search by domain

<http://emailbydomain.com>

Auto manuals search

<http://auto.somanuals.com>

TV manuals search

<http://tv.somanuals.com>