

DYNE X TM ●●●

32" LCD TV

DX-32L130A10

USER GUIDE

Dynex DX-32L130A10

32" LCD TV

Contents

CHILD SAFETY	1
Important safety instructions	2
Warnings	2
Cautions	3
Installing and removing the stand	4
Installing the stand	4
Removing the stand	4
Installing a wall-mount bracket	4
TV components	5
Front and side controls	5
Back connections	5
Side connections	6
Remote control	6
Using the remote control	7
Installing remote control batteries	7
Aiming the remote control	7
Programming a universal remote control to work with your TV	8
Making connections	8
Connecting the power	8
Connecting an antenna, cable TV, or satellite TV box	9
Connecting a VCR	9
Connecting a camcorder or gaming console	10
Connecting an HDMI device	10
Connecting a component video device	11
Connecting an S-video device	11
Connecting a computer	12
Connecting headphones	12
Connecting an external sound system	12
Turning on your TV for the first time	13
Understanding the basics	13
Turning your TV on or off	13
Selecting the video input source	13
On-screen menu overview	14
Navigating the menus	15
Selecting a channel	15
Adjusting the volume	15
Displaying additional information	15
Adjusting the picture	15
Adjusting the sound	16
Selecting the audio mode	16
Changing channel settings	16
Setting parental controls	17
Adjusting the setup	18
Troubleshooting	18

Maintenance	19
Cleaning	19
Specifications	19
Legal notices	19
One-year limited warranty	21

CHILD SAFETY

It makes a difference how and where you use your flat panel display

As you enjoy your new product, keep these safety tips in mind

The issue

The home theater entertainment experience is a growing trend, and larger TVs are popular purchases. However, TVs are not always supported on the proper stands or installed according to the manufacturer's recommendations. We and the consumer electronics industry are committed to making home entertainment enjoyable and safe.

TVs that are inappropriately placed on dressers, bookcases, shelves, desks, speakers, chests, or carts may fall over and cause injury.

Tune into safety

- One size of TV stand does not fit all. Use only a TV stand rated for the weight of your TV.
- Carefully read and understand all enclosed instructions for proper use of this product.
- Don't let children climb on or play with entertainment system furniture and TVs.
- Don't place TVs on furniture that can easily be used as steps, such as a chest of drawers.
- Remember that children can become excited while watching a program, especially on a "larger-than-life" TV. Make sure that you place or install the TV where it cannot be pushed, pulled over, or knocked down.
- Make sure that you route all cords and cables so that they cannot be pulled or grabbed by curious children.



Wall mounting

If you decide to wall mount your TV, always remember:

- Use only a wall mount rated for the weight of your TV and that has been recommended by this TV manufacturer, listed in this manual, or otherwise listed by an independent laboratory as suitable for your TV. One size of wall mount does not fit all.
- Follow all instructions supplied by the TV and wall mount manufacturers.
- If you have any doubts about your ability to safely wall mount your TV, get help from a professional installer.
- Make sure that the wall where you are mounting the TV is appropriate. Some wall mounts are not designed to be mounted to walls backed with steel studs or cinder blocks. If you are unsure, ask a professional installer.
- TVs can be heavy. At least two people are required for safe wall mount installation.



Important safety instructions

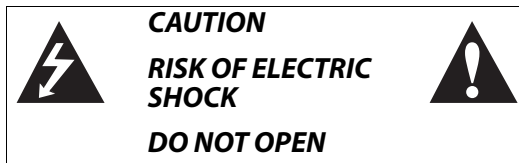

This symbol indicates that dangerous voltage constituting a risk of electric shock is present within your TV. This label is located on the back of your TV.



This symbol indicates that there are important operating and maintenance instructions in the literature accompanying your TV.

- 1 Read these instructions.
- 2 Keep these instructions.
- 3 Heed all warnings.
- 4 Follow all instructions.
- 5 Do not use this apparatus near water.
- 6 Clean only with a dry cloth.
- 7 Do not block any ventilation openings. Install in accordance with the manufacturer's instructions.
- 8 Do not install near any heat sources such as radiators, heat registers, stoves, or other apparatus (including amplifiers) that produce heat.
- 9 Do not defeat the safety purpose of the polarized or grounding-type plug. A polarized plug has two blades with one wider than the other. A grounding type plug has two blades and a third grounding prong. The wide blade or the third prong are provided for your safety. If the provided plug does not fit into your outlet, consult an electrician for replacement of the obsolete outlet.
- 10 Protect the power cord from being walked on or pinched particularly at plugs, convenience receptacles, and the point where they exit from the apparatus.
- 11 Only use attachments/accessories specified by the manufacturer.
- 12 Use only with a cart, stand, tripod, bracket, or table specified by the manufacturer, or sold with the apparatus. When a cart is used, use caution when moving the cart/apparatus combination to avoid injury from tip-over.
- 13 Unplug this apparatus during lightning storms or when unused for long periods of time.
- 14 Refer all servicing to qualified service personnel. Servicing is required when the apparatus has been damaged in any way, such as power-supply cord or plug is damaged, liquid has been spilled or objects have fallen



into the apparatus, the apparatus has been exposed to rain or moisture, does not operate normally, or has been dropped.

- 15 The wall plug is the disconnecting device. The plug must remain readily operable.
- 16 An apparatus with a three-prong, grounding-type plug is a Class I apparatus, which needs to be grounded to prevent possible electric shock. Make sure that you connect this Class I television to a grounding-type, three-prong outlet.
- 17 Remote control batteries should not be exposed to excessive heat such as sunshine, fire, or the like.
- 18 The apparatus should not be exposed to dripping or splashing, and no objects filled with liquids, such as vases, should be placed on the apparatus.

Warnings

Electric shock hazard

To reduce the risk of fire or electric shock, do not remove any cover or expose the device to rain or moisture. No user-serviceable parts are inside. Refer servicing to qualified service technicians.

Lightning

For added protection for your device receiver during a lightning storm, or when it is left unattended and unused for long periods of time, unplug it from the power outlet and disconnect any antenna or cable system. This helps prevent property damage and personal injury from lightning and power line surges.

Power lines

An outside antenna system should not be located in the vicinity of overhead power lines or other electric light or power circuits, or where it can fall into such power lines or circuits. When installing an outside antenna system, extreme care should be taken to keep from touching such power lines or circuits as contact with them might be fatal.

Handling the LCD panel

- Your TV's screen is made of glass. Do not drop your TV or hit, jolt, or press hard against the LCD panel. If the screen breaks, be careful of broken glass.
- If the LCD panel is broken, make absolutely sure that you do not touch the liquid in the panel. This may cause skin inflammation.
- If the liquid gets in your mouth, immediately gargle, rinse, and consult with your doctor. Also, if the liquid gets in your eyes or touches your skin, consult with your doctor after rinsing for at least 15 minutes or longer in clean water.

Replacement parts

When replacement parts are required, make sure that the service technician uses replacement parts specified by the manufacturer that have the same

characteristics as the original part. Unauthorized substitutions may result in fire, electric shock, personal injury, or other hazards.

Safety check

After completing any service or repair to this device, ask the service technician to perform routine safety checks to determine that your TV is in correct operating condition.

Power source

Operate your TV only from the type of power source indicated on the marking label. If you are not sure of the type of power supplied to your home, consult an electrician or your local power company.

Cautions

Damage requiring service

Unplug this TV from the power outlet and refer servicing to qualified service personnel under the following conditions:

- When the power supply cord or plug is damaged or frayed.
- If liquid has been spilled or objects have fallen into your TV.
- If your TV has been exposed to rain or water.
- If your TV does not operate normally by following the operating instructions. Adjust only those controls that are covered by the operating instructions because incorrect adjustment of other controls may result in damage and will often require extensive work by a qualified technician to restore your TV to its normal operation.
- If your TV has been dropped or damaged in any way.
- When your TV exhibits a distinct change in performance.

Outdoor antenna grounding

If an outside antenna or cable system is connected to your TV, make sure that the antenna or cable system is grounded to provide some protection against voltage surges and built-up static charges. Article 810 of the National Electrical Code, ANSI/NFPA No. 70, provides information with respect to correct grounding of the mast and supporting structure, grounding of the lead-in wire to an antenna discharge unit, size of grounding conductors, location of the antenna-discharge unit, connection to grounding electrodes, and requirements for the grounding electrode.

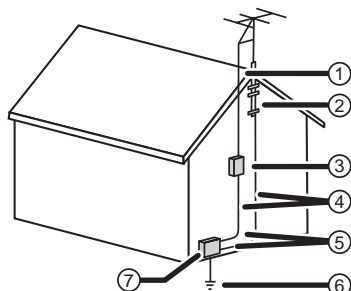

- ① Antenna lead-in wire
- ② Grounding clamp
- ③ Antenna discharge unit
- ④ Grounding conductors
- ⑤ Ground clamps
- ⑥ Power service grounding electrode system
- ⑦ Electric service equipment

Note to CATV system installer

Article 820 of the National Electrical Code, ANSI/NFPA No. 40 provides guidance for correct grounding. Specifically, it states that the cable ground must be connected to the grounding system of the building as close to the point of cable entry as practical.

Condensation

Moisture will form on the TV if the TV is brought from cool surroundings into a warm room or if the temperature of the room rises suddenly. When this happens, the TV's performance may be impaired. To prevent this, let the TV stand in its new surroundings for about an hour before switching it on, or make sure that the room temperature rises gradually. Condensation may also form during the summer if the TV is exposed to the breeze from an air conditioner. In such cases, change the location of the TV.

Mobile telephone warning

To avoid interference with your TV picture and sound, operating problems, or even damage, keep your cordless and cellular telephones away from the TV.

End of life directives

Your TV contains tin-lead solder and a fluorescent lamp containing a small amount of mercury. Disposal of these materials may be regulated for environmental reasons. Your TV also contains material that can be recycled and reused. For disposal or recycling information, contact your local authorities or the Electronic Industries Alliance at www.eia.org to find a recycler in your area.

Non-active pixels

The LCD panel contains almost 3 million thin film transistors, which provide exceptionally sharp video quality. Occasionally, a few non-active pixels may appear on the screen as a fixed blue, green, or red point. These non-active pixels do not adversely affect the performance of your TV, and are not considered defects.

Installing and removing the stand

You must install your TV into the stand for it to stand upright on a cabinet or other flat surface. If you intend to mount your TV on a wall or other vertical surface, you must remove the stand column.

Warning: Before attempting assembly or removal of the stand, unplug the AC power cord.

Cautions:

Read these instructions thoroughly before attempting this installation.

Make sure that you handle your TV very carefully when attempting assembly or removal of the stand. If you are not sure of your ability to do this, or to use the tools necessary to complete this job, refer to a professional installer or service personnel. The manufacturer is not responsible for any damages or injuries that occur due to mishandling or improper assembly.

When using a table or bench as an aid to assembly, make sure that you place the TV on a soft cushion or covering to prevent accidental scratching or damage to your TV's finish.

The speaker is not intended to support the weight of your TV. Do not move or handle your TV by the speaker. This can cause damage to your TV that is not covered by the manufacturer's warranty.

Installing the stand

To install the stand:

- 1 Remove the stand from the box and place it on a table or bench.
- 2 Lay your TV flat, screen down, on a clean, flat, stable surface, such as a tabletop. Make sure that you place it on a soft cushion or cloth so that your TV is not scratched.

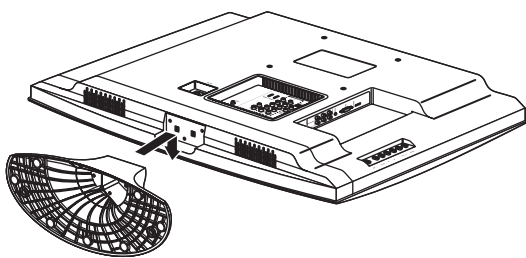

- 3 Align the base with the bottom of the TV, then secure the base to the TV with the four M5XL 14 mm screws provided.



- 4 Set your TV upright on a stable surface.

Removing the stand

To remove the stand from the stand column:

- 1 Lay your TV face down on a table or bench. Make sure that you place it on a soft cushion or cloth so that your TV is not scratched).
- 2 Remove the four M5XL 14 mm screws securing the base to the TV, then remove the base.

Installing a wall-mount bracket

If you want to attach the TV to a wall-mount bracket (not provided), you should first remove the stand pedestal if it is pre-attached (see above).

To attach your TV to a wall-mount bracket:

Warning: These servicing instructions are for use by qualified service personnel only. To reduce the risk of hazards, do not perform any servicing other than that contained in the operating instructions unless you are qualified to do so.

- Secure the wall-mount bracket to the back of your TV using the four screws provided with the bracket.



TV components

Front and side controls

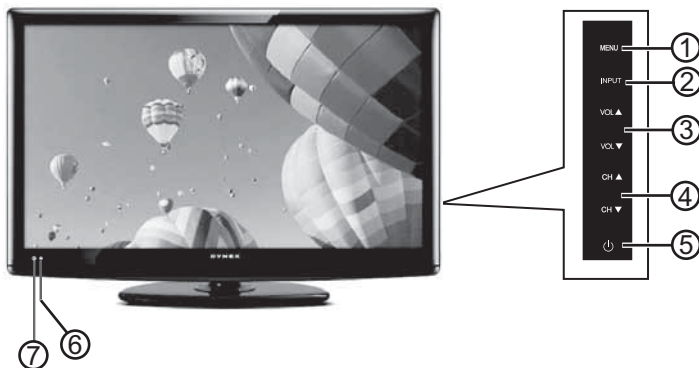

#	Component	Description
1	MENU	Press to open the on-screen menu.
2	INPUT	Press to select the video input source.
3	VOL ▲/▼	Press to increase or decrease the volume.
4	CH ▲/▼	Press to go to the next or previous channel in the channel list.
5	⏻ (power) button	Press to turn on your TV. Press again to put your TV in standby mode.
6	Power/Standby indicator	Lights blue when your TV is turned on. Lights red when your TV is in standby mode.
7	Remote sensor	Receives signals from the remote control. Do not block.

Back connections

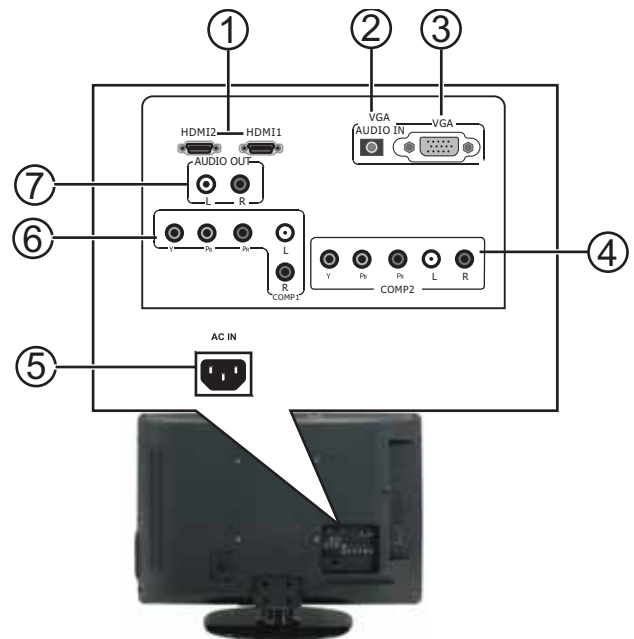

#	Component	Description
1	HDMI1 and HDMI2 jacks	Connect an HDMI device, such as a cable box or DVD player, to one of these jacks. An HDMI cable carries both video and audio, so you do not need to make an audio connection. For more information, see "Connecting an HDMI device" on page 10.
2	VGA AUDIO IN jack	Connect the mini plug from your computer's sound card output to this jack. For more information, see "Connecting a computer" on page 12.
3	PC VGA jack	Connect a 15-pin VGA cable from a computer to this jack. For more information, see "Connecting a computer" on page 12.
4	COMP2 (Y, Pb, Pr and audio L and R) jacks	Connect a component video device to these jacks. Cables are often color-coded to connectors. For more information, see "Connecting a component video device" on page 11.
5	AC IN	Connect the AC power cord to this connector.
6	COMP1 (Y, Pb, Pr and audio L and R) jacks	Connect a component video device to these jacks. Cables are often color-coded to connectors. For more information, see "Connecting a component video device" on page 11.
7	AUDIO OUT jacks (L and R)	Connect audio cables (L and R) from these jacks to an external audio amplifier or receiver.

Side connections

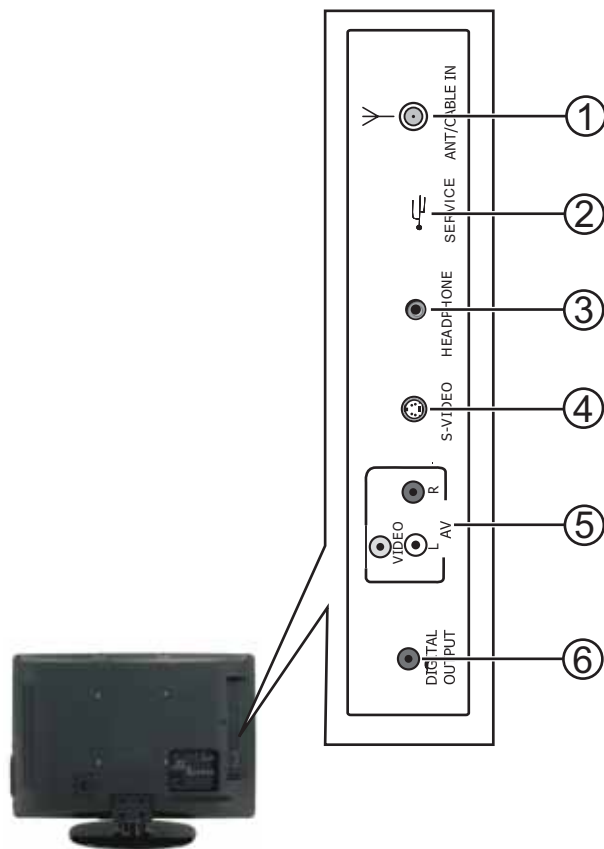

##	Component	Description
1	ANT/CABLE IN jack	Connect an antenna, cable TV, or a satellite box to this jack. For more information, see "Connecting an antenna, cable TV, or satellite TV box" on page 9.
2	SERVICE port	For service update only. Do not use.
3	HEADPHONE jack	Plug your headphones into this jack.
4	S-VIDEO jack	Connect an S-Video cable from a VCR or DVD player to this jack. Also requires an audio connection or audio output from an amplifier (see "Connecting an S-video device" on page 11).
5	AV (Video and audio jacks)	Connect a composite video and audio L and R from a VCR, game console, or camcorder to these jacks.
6	DIGITAL OUTPUT	Connect a digital coaxial audio cable to this jack. (Only available in digital TV or HDMI modes.)

Remote control

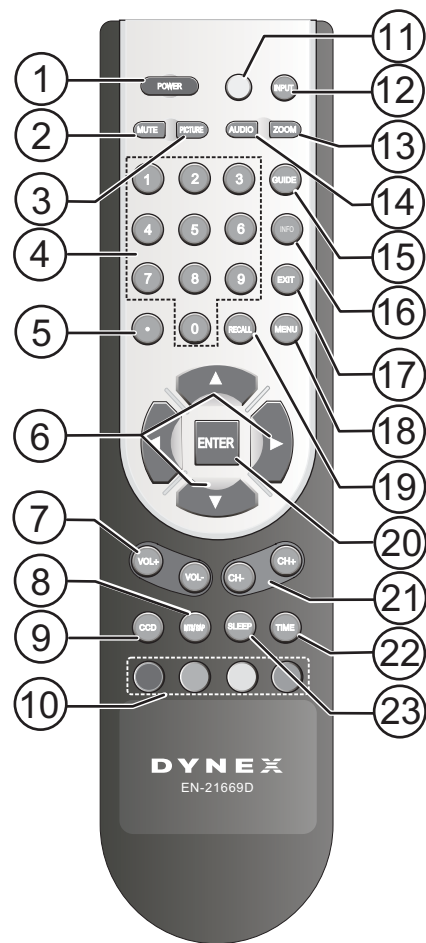

#	Button	Description
1	POWER	Press to turn on your TV. Press again to put your TV in Standby mode.
2	MUTE	Press to turn off the sound. Press again to turn on the sound.
3	PICTURE	Press to select the video mode.
4	Numbers	Press to enter channel numbers or the parental control password.
5	• (dot)	Press to select a digital sub-channel.
6	▲ ▼ ► ◀	Press to navigate through the on-screen menus.
7	VOL+/VOL-	Press to increase or decrease the volume.
8	MTS/SAP	Press to enable the SAP (Second Audio Program) function. This lets you listen to a program using an alternative second language. Function availability depends on your TV provider.
9	CCD	Press to turn closed captioning on or off. For more information, see "Adjusting the setup" on page 18.
10	Electronic Program Guide (EPG) function buttons	After pressing the GUIDE button in the digital TV channel option, the same color buttons will appear with explanations in the on-screen display (OSD). Follow the steps illustrated in the OSD.
11	Power indicator	Lights when you turn your TV on.

#	Button	Description
12	INPUT	Press to open the <i>INPUT SOURCE</i> menu, then press ▲ or ▼ to select the video input source. You can select TV, AV, S-video, Component 1, Component 2, VGA, HDMI1, or HDMI2.
13	ZOOM	Press to select the video display format.
14	AUDIO	Press to select the sound mode.
15	GUIDE	Press to open the electronic program guide (EPG) function.
16	INFO	Press to display the information banner. For more information, see "Displaying additional information" on page 15.
17	EXIT	Press to close the on-screen menu.
18	MENU	Press to open the on-screen menu.
19	RECALL	Press to return to the channel you were previously viewing.
20	ENTER	During TV viewing, press to switch to the keyed in channel entry. In menu mode, press to confirm selections in an on-screen menu or to open a submenu.
21	CH+/CH-	Press to go to the next or previous channel in the channel list. For more information, see "Selecting a channel" on page 15.
22	TIME	Press to display the current time.
23	SLEEP	Press to set the sleep timer to have your TV turn off automatically.

Remove batteries when they no longer have a charge. Chemicals may leak into the battery compartment. Battery chemicals can cause a rash. If chemicals leak, clean the battery compartment with a cloth.

Remove the batteries if you do not intend to use the remote control for an extended amount of time.

Do not dispose of batteries in a fire. Dispose of them as hazardous waste.

Aiming the remote control

To use the remote control:

- Point the remote control towards the remote sensor on the front of your TV. The remote control should be used within 26 feet (7.9 m) of your TV.



Notes:

Do not expose the remote control to shock or liquids.

Do not use the remote control in an area with high humidity.

Do not place the remote control in direct sunlight.

Do not place objects, such as furniture, between the remote control and the remote sensor.

The remote control may not work if direct sunlight or bright light shines on the remote sensor. Either move your TV or change the angle at which you use the remote control.

Using the remote control

Installing remote control batteries

To install remote control batteries:

- Open the battery compartment cover by sliding it off.
- Insert two AAA batteries into the battery compartment. Make sure that the + and – symbols on the batteries match the + and – symbols in the battery compartment.



- Replace the cover.

Notes:

Do not mix different types of batteries.

Do not mix old and new batteries.

Programming a universal remote control to work with your TV

You can operate your TV with a new or existing universal remote control.

To program a universal remote control:

- 1 Find the code for your universal remote control by identifying its model (or your set-top box's remote control manufacturer and model) on the charts below, then make note of the numbered code below it. You will use the numbered code to program your remote control to work with your TV.

Dynex TV codes for universal remote controls (for all Dynex TVs manufactured after Jan. 1, 2007)

Universal remote control manufacturer and model

Philips PHDVD5, PH5DSS, PMDVR8, PDVR8	RCA RCU807	One for All URC-6690	Sony RM-VL600
---	---------------	-------------------------	------------------

115

135

0464

8043

Set-top box manufacturer and model

Comcast M1057	Dish Network VIP508, VIP622	Motorola DRC800	TIVO Series 3, HD	DirectTV RC23
------------------	--------------------------------------	--------------------	----------------------	------------------

0463

720

0463

0091

10463

Codes for other remote controls are available online at:
www.dynexproducts.com\t-customer_support.aspx

Tips:

- The brand name is often visible on the front of the universal remote control, and the model number is often visible on the back.
 - If your universal remote control isn't listed on the chart, refer to your universal remote control's instructions and try codes for the brands Orion, Emerson, Memorex, Sansui, Sylvania, or Zenith. You may need to try several codes before finding a match.
- 2 Follow your universal remote control's instructions to enter the code you found in Step 1.

Tips:

 - If your universal remote control has a code search feature, run a code search to identify a code that matches your TV. See your universal remote control's instructions for details.
 - If your universal remote control has a "Learn" feature, you can manually program it using your TV remote to "teach" the commands one at a time. See your universal remote control's instructions for details.
 - 3 If all else fails, you must use a different universal remote control that can operate both your set-top box and your TV. Five such remotes are listed on the chart, but many other compatible models are available in the market.

For more help, call technical support for your universal remote control or set-top box manufacturer, or call the Dynex Customer Care Center at 1-800-305-2204.

Making connections

Cautions:

Check the terminals for position and type before making any connections.

Loose connections can result in image or color problems. Make sure that all connections are tight and secure.

The external audio/video equipment shown in these illustrations may be different from your equipment. If you have questions, refer to the user manual that came with your equipment.

Always turn the power off when connecting external equipment.

Your TV does not support DTS audio format. If you choose a DTS audio format, you may not hear the correct audio output from the TV speakers.

Connecting the power

To connect the power:

- Connect the power cord to the AC in connector on the back of your TV, then plug the cord into an AC power outlet.

Important: Your TV only works on 120 V, 60 Hz power.



Notes:

Your TV should only be operated from the power source indicated on the label.

Always unplug the AC power cord from the AC power outlet when you will not be using your TV for an extended period of time.

Connecting an antenna, cable TV, or satellite TV box

Important: The antenna connector should only be finger-tightened. Do not tighten this connector with any tool, or you may damage your TV.

To connect an antenna, cable TV, or satellite TV box:

- 1 Turn off the TV before connecting the antenna.
- 2 Connect one end of a coaxial cable (not included) to the **RF OUT** jack on the antenna or on the cable or satellite TV box. If you are using an antenna with twin-lead cable, you may need a 300-75 ohm adapter (not provided) to connect it to the back of your TV. Likewise, if you are using several antennas, you may need a combiner (not provided).

- 3 Connect the other end of the cable to the **ANT/CABLE IN** jack on the side of your TV.

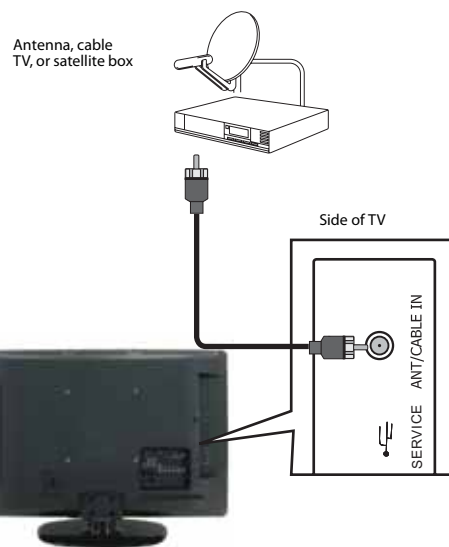

Notes:

- Use a coaxial cable to eliminate interference and noise from radio waves.
- Do not bundle the coaxial cable with the power cord or other cables.
- If the antenna is not installed correctly, contact qualified service personnel to correct the problem.

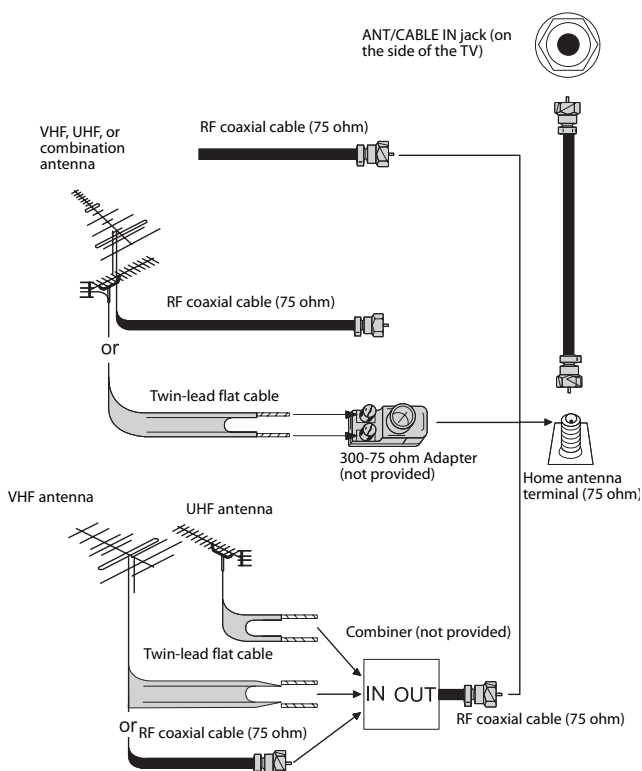

Connecting a VCR

To connect a VCR:

- 1 Make sure that your TV's power cord is unplugged and the VCR is turned off.
- 2 Connect an AV cable to the **AV VIDEO** and **AUDIO** out jacks on the VCR.

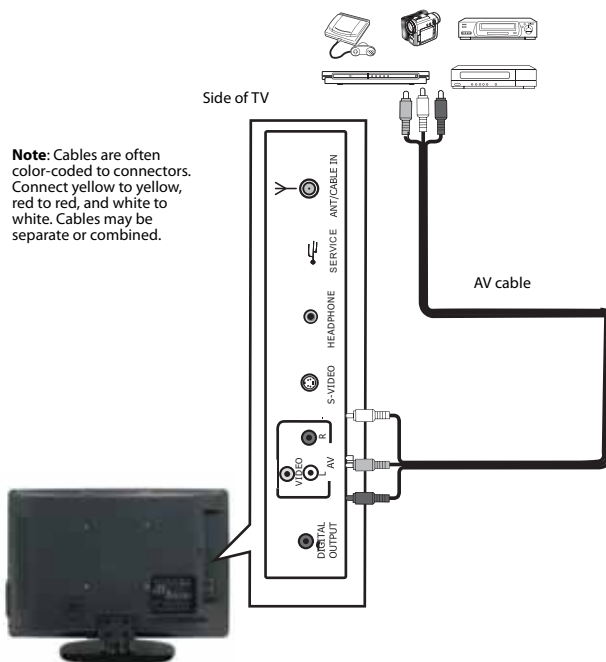

Note: Cables are often color-coded to connectors. Connect yellow to yellow, red to red, and white to white. Cables may be separate or combined.

- 3 Connect the other end of the AV cable to the **AV VIDEO** and L and R audio jacks on the side of your TV.

To play from the VCR:

- 1 Turn on your TV, then press **INPUT**. The **INPUT SOURCE** menu opens.
- 2 Press **▲** or **▼** to select **AV**, then press **ENTER**.
- 3 Turn on the VCR, insert a videotape, then press **PLAY** on the VCR.

Connecting a camcorder or gaming console

Tip: Some game consoles have an HDMI connector, which can be used for a better picture.

To connect a camcorder or game:

- 1 Make sure that your TV's power cord is unplugged and the camcorder or gaming console is turned off.
- 2 Connect an AV cable to the **AV OUT VIDEO**, **AUDIO-L**, and **AUDIO-R** jacks on the camcorder or gaming console.

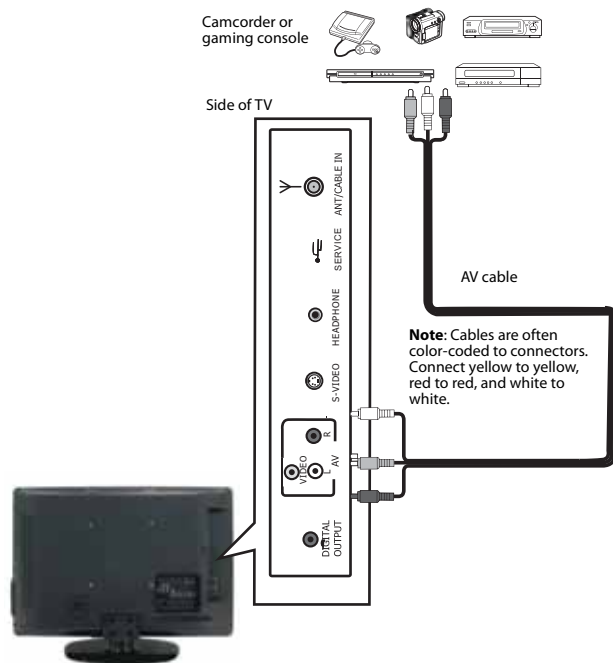

- 3 Connect the other end of the cable to the **AV** jack and the **AV** audio in jacks on the side of your TV.

To play from a camcorder or gaming console:

- 1 Turn on your TV, then press **INPUT**. The **INPUT SOURCE** menu opens.
- 2 Press **▲** or **▼** to select **AV**, then press **ENTER**.
- 3 Turn on the camcorder or game, and set it to the correct output mode. See the camcorder's or gaming console's user guides for more information.

Connecting an HDMI device

To connect an HDMI device:

- 1 Make sure that your TV's power cord is unplugged and the HDMI device is turned off.
- 2 Connect an HDMI cable to the **HDMI OUT** jack on the HDMI device.

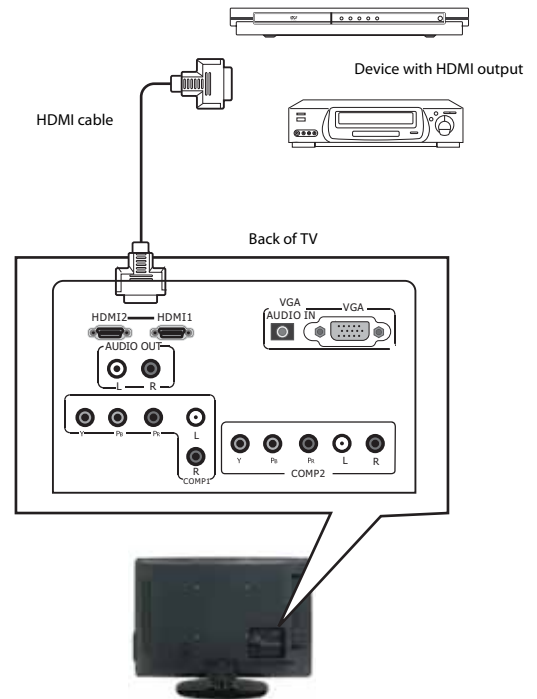

- 3 Connect the other end of the cable to the **HDMI1** or **HDMI2** jack on the back of your TV.

To play from the HDMI device:

- 1 Turn on your TV, then press **INPUT**. The **INPUT SOURCE** menu opens.
- 2 Press **▲** or **▼** to select **HDMI 1** or **HDMI 2**, then press **ENTER**.
- 3 Turn on the HDMI device, and set it to the correct output mode. See the HDMI device's user guide for more information.

Connecting a component video device

A component (Y, Pb, Pr) picture can be displayed only when a 480i, 480P, 720P, or 1080i signal is received.

To connect a component video device:

- 1 Make sure that your TV's power cord is unplugged and the component video device is turned off.
- 2 Connect a component video cable to the **COMPONENT OUT** jacks on the component video device.

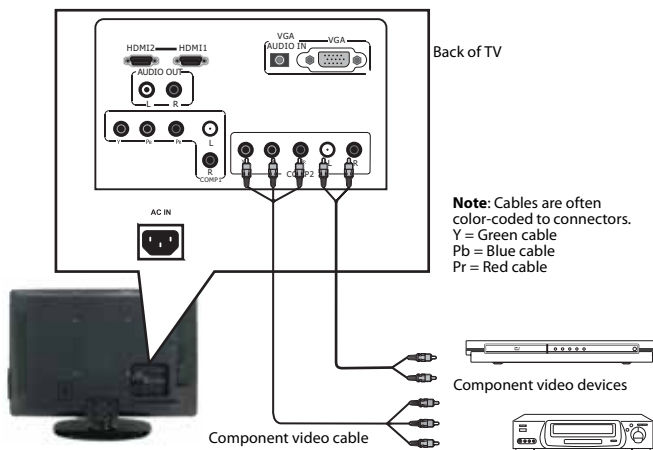

- 3 Connect the other end of the component video cable to the **COMP1** or **COMP2** jacks on the back of your TV.
- 4 Connect an audio cable to the **AUDIO OUT** jacks (L/R) on the component device.
- 5 Connect the other end of the audio cable to the **COMP1** or **COMP2** audio jacks on the back of your TV.

To play from a component device:

- 1 Turn on your TV, then press **INPUT**. The **INPUT SOURCE** menu opens.
- 2 Press **▲** or **▼** to select **COMP1** or **COMP2**, then press **ENTER**.
- 3 Turn on the component video device and set it to the correct output mode. See the component video device's user guide for more information.

Connecting an S-video device

To connect an S-video device:

- 1 Make sure that your TV's power cord is unplugged and the S-Video device is turned off.
- 2 Connect an S-Video cable to the **S-VIDEO OUT** jacks on the S-Video device.

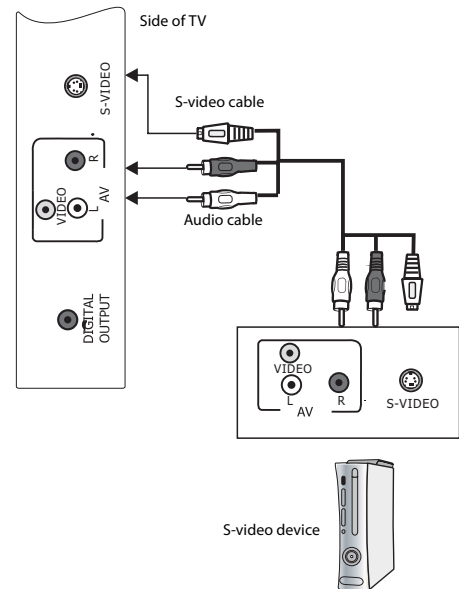

- 3 Connect the other end of the S-video cable to the **S-VIDEO** jack on the side of your TV.
- 4 Connect an audio cable to the **AUDIO OUT** jacks (L/R) on the component device.
- 5 Connect the other end of the audio cable to the **AV** audio jacks on the back of your TV.

To play from a component device:

- 1 Turn on your TV, then press **INPUT**. The **INPUT SOURCE** menu opens.
- 2 Press **▲** or **▼** to select **S-VIDEO**, then press **ENTER**.
- 3 Turn on the S-video device and set it to the correct output mode. See the S-video device's user guide for more information.

Connecting a computer

Tip: Some computers have an HDMI connector, which can be used for a better picture.

To connect a computer:

- 1 Make sure that your TV's power cord is unplugged and the computer is turned off.
- 2 Connect a VGA cable to the **VGA** jack on the computer, then connect the other end of the cable to the **VGA** jack on the back of your TV.

Note: The VGA cable should be a 15-pin D-Sub (analog RGB) cable.

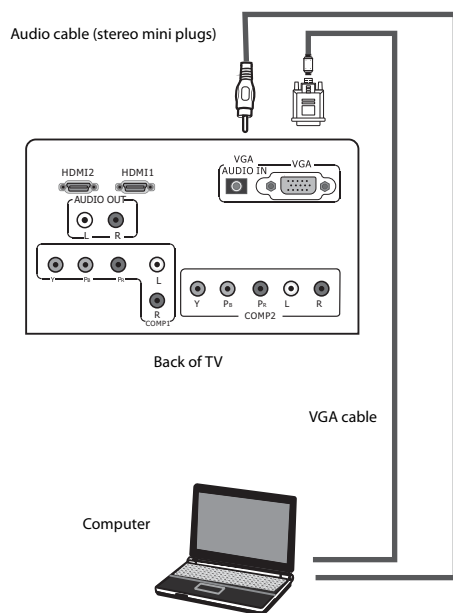

- 3 Connect an audio cable to the **AUDIO OUT** jack on the computer, then connect the other end of the cable to the **VGA AUDIO IN** jack on the back of your TV.

Note: The audio cable should have a stereo mini plug.

To play video from a computer:

- 1 Turn on your TV, then press **INPUT**. The **INPUT SOURCE** menu opens.
- 2 Press **▲** or **▼** to select **VGA**, then press **ENTER**.
- 3 Turn on the computer, then adjust the display properties, if necessary.

Connecting headphones

To connect headphones:

- Connect your headphones to the **HEADPHONE** jack on the side of your TV.

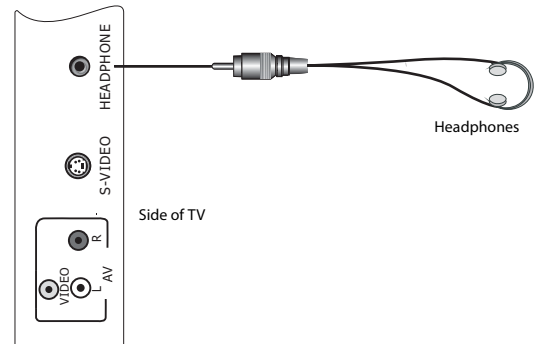

Note: Loud noise can damage your hearing. When using headphones, use the lowest volume setting that still lets you hear the sound.

Connecting an external sound system

To connect an external audio device:

- 1 Make sure that your TV's power cord is unplugged and the component video device is turned off.
- 2 Connect an analog audio (L and R) cable to the **Audio Out (L/R)** jacks on the back of your TV.
- OR -
Connect a digital coaxial cable to the **DIGITAL OUTPUT** jack on the side of your TV.

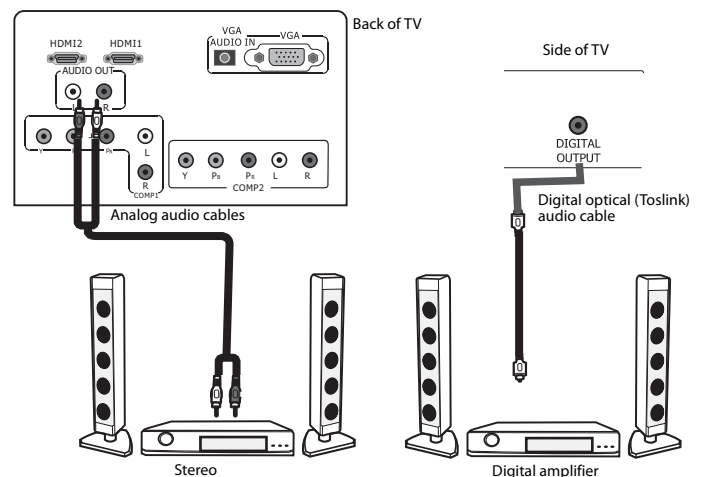

- 3 Connect the other end of the analog audio (L and R) cable to the **AUDIO IN** jacks on the analog stereo receiver.
- OR -
Connect the other end of the digital coaxial cable to the **DIGITAL INPUT** jack on the digital amplifier.

To play audio from a digital sound system:

- 1 Turn on your TV.
- 2 Turn on the external audio device and set it to the correct output mode. See the audio device's user guide for more information.

Turning on your TV for the first time

To configure your TV:

- 1 Make sure that you have inserted the batteries in the remote control, connected the antenna, cable, or cable box to the TV, and connected the AC power.
- 2 Press **POWER**, then wait several seconds. The initial setup screen opens (only the first time you turn on your TV) and guides you through setting up your TV's operational settings.

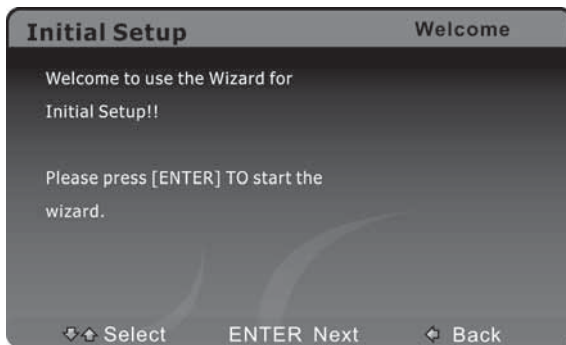

- 3 Press **ENTER**. The setup wizard starts with the *Language* screen.

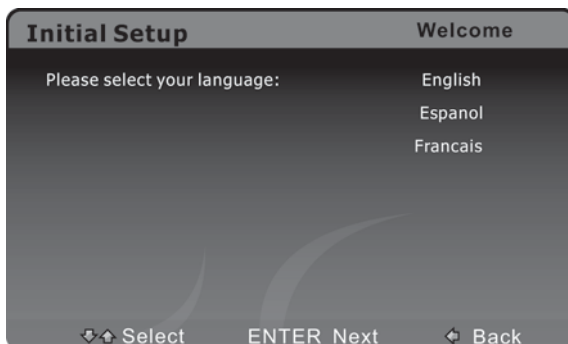

- 4 Press **▲** or **▼** to select the language you want, then press **ENTER**. The *Tuner* screen opens.

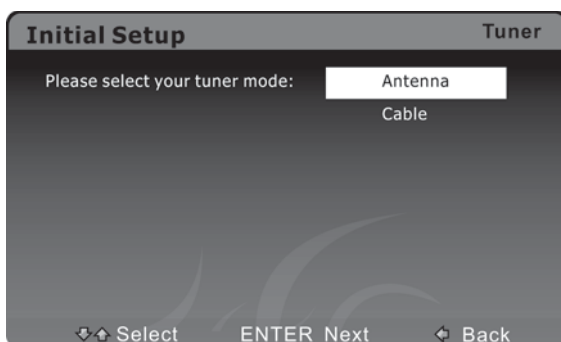

- 5 Press **▲** or **▼** to select **Antenna** or **Cable**, then press **ENTER**. The *Channel Scan* screen opens.

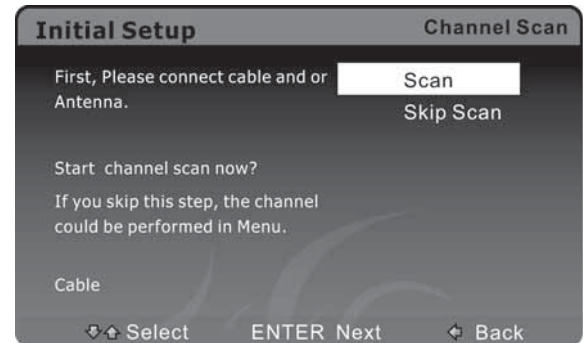

- 6 Press **▲** or **▼** to select **Scan**, then press **ENTER**. The channel scan begins.

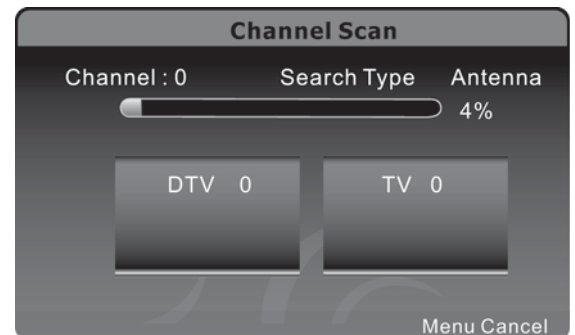

Note: Channel scan is not necessary if you are using a satellite or cable box.

Understanding the basics

Turning your TV on or off

To turn your TV on or off (standby mode):

- 1 Plug the power cord into an AC power outlet.
- 2 Press **POWER**. Your TV turns on.
- 3 Press **POWER** again to turn off your TV. When you turn off your TV, it goes into standby mode.

Warning: When your TV is in standby mode, it is still receiving power. To completely disconnect power, unplug the power cord.

Note: If your TV does not receive an input signal for several minutes, it automatically goes into standby mode.

Selecting the video input source

The first time you turn on your TV, you must select the TV signal source. Your TV stores this information, so you do not need to change the TV signal source unless it changes. For example, you change from an outside antenna to cable TV.

To select the video input source:

- 1 Turn on your TV, then press **INPUT** on the remote or on the TV. The *INPUT SOURCE* menu opens.
- 2 Press **▲** or **▼** to highlight the video source, then press **ENTER**.

You can choose from **TV, AV, S-video, Component 1, Component 2, VGA, HDMI1, or HDMI2.**

On-screen menu overview

Use the on-screen menu to configure the various operational settings of your TV. To access the menu, press **MENU**. The menus and their corresponding functions are described in the following table:

Video	Picture Mode	Lets you enable one of five preset viewing options optimized for different viewing conditions.
	Brightness	Lets you adjust the level of brightness on the screen. Increasing brightness can add more light to dark areas of the picture.
	Contrast	Lets you adjust the level of picture contrast. Increasing the contrast adds to more light to the white areas of the picture.
	Saturation	Lets you adjust the level of color intensity.
	Hue	Lets you adjust the overall color of the picture.
	Sharpness	Lets you adjust the focus of the picture. Increase sharpness for a clearer picture, or decrease sharpness for a smoother picture.
	Color temperature	Lets you select one of three preset color temperature settings: Cool, Standard, and Warm.
	Advanced video	Accesses advanced video settings such as DNR, Black Level Extender, White Peak Limiter, Flesh Tone, Adaptive Luma Control, and Overscan (in HDMI only).
Audio	Balance	Lets you adjust the balance between the left and right speakers.
	Surround Sound	Lets you turn the surround sound effect on or off.
	Equalizer	Lets you select the audio frequency you want to adjust and change its value.
	Auto Volume Control	Lets you select whether to apply the audio settings for all input sources, as well as for both analog and digital TV channels (OFF), or only to the current one (ON).
	SPDIF Type	Lets you select the preferred audio format for SPDIF audio signals. SPDIF is only available on digital channels or when using an HDMI device. Choose from PCM, Dolby Digital, or Off.

Setup	OSD Language	Lets you select the language for the on-screen display. Choose from English, French, or Spanish.
	Screen Mode	Lets you select the aspect ration of the screen. Choose from Normal, Wide, or Cinema to Zoom.
	DPMS	Use this setting when using your TV with a computer. When using a connected computer, lets the computer control if the screen is on or off.
	Time Setup	Lets you configure the system clock and time zone settings. You can also choose to enable the Date/Time features and set up the sleep timer.
	Caption	Lets you configure the settings for closed captioning (CC, also known as subtitles) in TV programs.
	Reset Default	Select Yes on this submenu to reset all operational settings to their default factory value. Do this only if any of the following conditions occurs: <ul style="list-style-type: none"> • The system fails to respond to the remote control (make sure the remote control batteries are still working and that you are within the transmission range). • The new configuration settings caused unexpected results. • You forget the system PIN.
Parental	Change Password	Lets you set a new password for parental controls.
	Channel Block	Lets you select certain channels to be blocked.
	Input Block	Lets you select certain input sources to be blocked.
	Program Block	Lets you select certain programs to be blocked.
	Clean All	Eliminates all channels (and presets) stored in the TV.
TV	Button Lock	Lets you lock TV buttons so that only the remote control can operate the TV. Removing the AC power and reconnecting it resets this function back to default.
	Tuner Mode	Lets you select the signal source for your TV (Antenna or Cable).
	Channel Scan	Lets you initiate an automatic channel scan to set up the available channels in your TV.
	Channel Skip	Lets you select certain channels to eliminate from the available channels list.
	MTS	Lets you enable the SAP (Second Audio Program) function. This lets you listen to a program using an alternative second language. Function availability depends on your TV provider.
	Audio Language	Lets you select the language track you prefer for viewing digital TV programs. Available options depend on your digital TV provider.

Navigating the menus

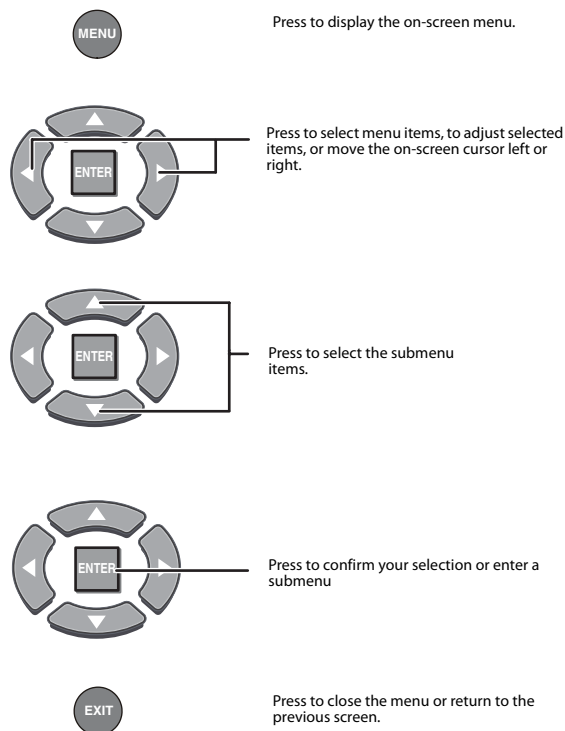

Selecting a channel

To select a channel:

- Press **CH+** or **CH-** to go to the next or previous channel on the memorized channel list.
- Press the number buttons to enter the analog or digital (main) channel number you want, then wait for the channel to change, or press **ENTER** to change the channel immediately.
- To select a digital sub-channel, press the number buttons to select the main digital channel, then press the dot (.) button to select the sub-channel. Wait for the channel to change, or press **ENTER** to change the channel immediately.

Note: Button presses must be within three seconds of each other.

- Press **RECALL** to go to the last channel viewed.

Digital sub-channels

A digital TV signal transmits more data than an analog signal. This increase in data provides a better picture and sound with less static and interference. The increased data capacity also lets broadcasters fit several channels into the same bandwidth as an analog signal. Broadcasters may use these sub-channels to transmit a variety of information, such as weather forecasts, foreign languages, and commercials. A digital sub-channel is indicated by the main channel number, followed by a dot, then the sub-channel number. For example, 5.1 indicates sub-channel 1 of main channel 5.

Adjusting the volume

To adjust the volume:

- Press **VOL+** or **VOL-** to increase or decrease the volume. A bar indicator and volume number shows you the change.
- Press **MUTE** to temporarily turn off all sound. Press **MUTE** again to restore the sound.

Displaying additional information

To display additional information:

- Press **INFO** to show an information banner. The information banner shows current program information such as channel number, video input source, and resolution.
 - Digital mode information—Displays channel number, station name, channel label (if preset), broadcast program name, TV rating, signal type, audio information, resolution, CC mode, current time, and current program start and end times.
 - Analog mode information—Displays channel number, channel label (if preset), signal type, audio information, and resolution.
- Press **GUIDE** to display program information in a window with live program content for the channel you are watching. Press **◀** or **▶** to scroll up or down the channels. Each time you pause at a channel, the program list will update with the program schedule for the channel and the window will show the live program for that channel. Press **GUIDE** or **EXIT** to exit this feature.

Adjusting the picture

To adjust the picture:

- 1 Press **MENU**. The *Main* menu opens.
- 2 Press **ENTER** or **▶**. The *Video* menu opens.

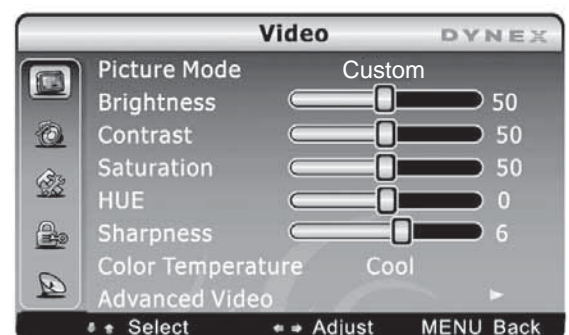

- 3 Press **▲** or **▼** to highlight an option, then press **◀** or **▶** to adjust the option. You can adjust:
 - **Picture Mode**—Lets you select a preset picture mode. You can select **Vivid**, **Standard**, **Theater**, **Energy Saving**, **Sport**, and **Custom**.
 - **Brightness**—Lets you increase or decrease the brightness of the picture. Increasing the brightness can add more light to dark areas of the picture, while decreasing the brightness can add more darkness to light areas of the picture.

- **Contrast**—Lets you increase or decrease the contrast of the picture. Increase the contrast to adjust the white areas of the picture or decrease the contrast to adjust the black areas of the picture.
- **Saturation**—Lets you adjust the intensity of the colors.
- **Hue**—Lets you adjust the overall color of the picture.
- **Sharpness**—Lets you increase the sharpness level for clearer images or decrease the sharpness level for smoother images.
- **Color temperature**—Lets you change the color temperature. You can select the color temperature from three options: **Cool**, **Standard**, or **Warm**.
- **Advanced Video**—Lets you access and adjust advanced video settings, such as **DNR**, **Black Level Extender**, **White Peak Limiter**, **Flesh Tone**, **Adaptive Luma Control** and **Overscan** (only in HDMI).

Choosing the display format

To choose the display format:

- Press **ZOOM** repeatedly to cycle through the available display formats. Options include:
 - **Normal**—Picture is displayed in a 4:3 aspect ratio.
 - **Zoom**—Picture is displayed to cover the entire screen.
 - **Wide**—Picture uses a widescreen aspect ratio.
 - **Cinema**—Picture is displayed in a 21:9 aspect ratio.

Adjusting the sound

To adjust the sound:

- 1 Press **MENU**. The *Main* menu opens.
- 2 Press **▲** or **▼** to highlight **Audio**, then press **ENTER** or **▶**. The *Audio* menu opens.

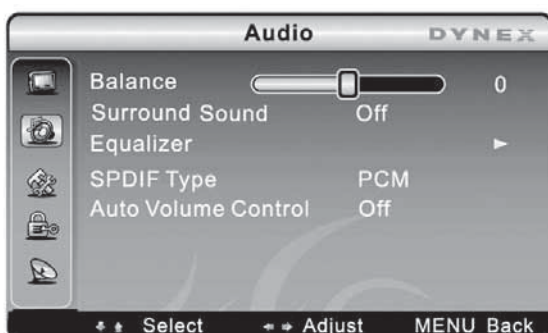

- 3 Press **▲** or **▼** to highlight an option, then press **◀** or **▶** to adjust the option. You can adjust:
 - **Balance**—Lets you adjust the volume of the left and right speakers.
 - **Sound Surround**—Lets you turn the surround sound effect on or off.
 - **Equalizer**—Lets you select the frequency you want to adjust and change its value.

- **Auto Volume Control**—Lets you turn automatic volume control on or off. The option keeps the audio in a preset range to eliminate large spikes in volume.
- **SPDIF Type**—Lets you select the SPDIF type. You can select **PCM**, **Dolby Digital**, or **Off**.

*Note: By selecting **SPDIF Type**, you can choose the digital audio out type. If **Audio Volume Control** is **On**, that means audio out control is activated.*

Selecting the audio mode

To select the audio mode:

- Press **AUDIO** to select sound mode. Options include **Standard**, **Speech**, **User**, and **MUSIC**.

Changing channel settings

To change the channel settings:

- 1 Press **MENU**. The *Main* menu opens.
- 2 Press **▲** or **▼** to highlight **TV**, then press **ENTER** or **▶**. The *TV* menu opens.

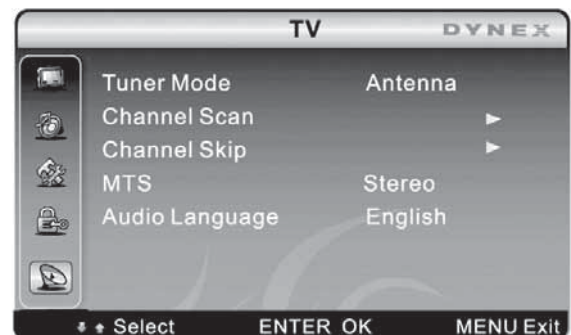

- 3 Press **▲** or **▼** to highlight an option, then press **◀** or **▶** to adjust the option. You can select:
 - **Tuner Mode**—Lets you select **Antenna** or **Cable**.
 - **Channel Scan**—Lets you scan for channels that have signals and stores the channels information in memory. When you press **CH+** or **CH-**, your TV skips any channels that do not have a signal.
 - **Channel Skip**—Lets you delete a channel stored in memory. When you press **CH+** or **CH-**, your TV skips the channel you deleted. You can still tune to the channel using the number buttons on the remote control.
 - **MTS**—Lets you select the sound mode. You can select **Mono**, **Stereo**, or **SAP** (second audio program).
 - **Audio Language**—Lets you select the audio language for a program (if other languages are available).

Setting parental controls

Parental controls let you prevent your children from watching inappropriate material on your TV. When set, parental controls read the rating of the program (with some exceptions, such as news and sports) and deny access to programs that exceed the ratings level you select. To watch programs that exceed the selected rating, you must enter a password.

Setting parental controls:

- 1 Press **MENU**. The *Main* menu opens.
- 2 Press **▲** or **▼** to highlight Parental, then press **ENTER** or **▶**. The *Parental* menu opens.

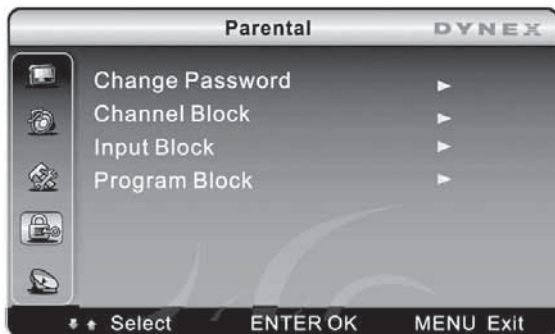

- 3 Press **MENU** to open the OSD option. When you first access these submenus, you must enter a password (default **0000**). Once you have entered the password, you can access parental controls.
- 4 Press **▲** or **▼** to highlight an option, then press **◀** or **▶** to adjust the option. You can select:
 - **Channel Block**—Lets you block any channel you select.
 - **Program Block**—
 - **A**—Rating Enable is on.
 - **B**—U.S. TV Ratings: You can choose TV ratings according to the illustration on the screen.
 - **C**—The settings for U.S. Movie Ratings, Canada (English) Ratings, and Canada (French) Ratings follow Step B. If you want to block an unrated program, turn on this function. You can select all the ratings listed in the chart below.
 - **Input Block**—Lets you block the input source with this function. For example, if you want to block AV input, just highlight **AV** and press **ENTER**. The AV input will be blocked.
 - **Change Password**—Lets you change the password. The first time you use this function, use the default password (**0000**). If you want to change it, first enter the new password then enter the same password again.
 - **Clean All**—Lets you remove all the channels stored on your TV. **Note:** If you choose this function, all the programs you preset will be lost.
 - **Button Lock**—Lets you lock TV buttons so that only the remote control can operate the TV. Removing the AC power and reconnecting it resets this function back to default.

Note: As you block ratings, all ratings higher than the ones you select are blocked as well. For example, if you choose to block the MPAA rating R, the higher ratings, NC-17 and X, are automatically blocked too.

The following ratings can be selected:

U.S. TV ratings (age-based)	
These ratings are determined by the Federal Communications Commission (FCC)	
TV-Y	All children.
TV-Y7	Suitable for children 7 and older.
TV-G	General audiences.
TV-PG	Parental guidance suggested.
TV-14	Parental guidance strongly suggested.
TV-MA	Mature audiences only.

U. S. TV ratings (content-based)	
FV	Fantasy violence.
D	Suggestive dialog.
L	Strong language.
S	Sexual situations.
V	Violence.

U.S. movie (MPAA) ratings	
These ratings are determined by the Motion Picture Association of America (MPAA).	
G	General audiences.
PG	Parental guidance suggested.
PG-13	Suitable for children 13 and older.
R	Parental guidance suggested for children under 17.
NC-17	Not suitable for children under 17.
X	Adults only.

Canadian English ratings	
These ratings are based on the Canadian Home Video Rating System determined by the Canadian Motion Picture Distributors Association (CMPDA).	
C	Suitable for all children.
C8+	Suitable for children 8 and older.
G	General audiences.
PG	Parental guidance suggested.
14+	Suitable for children 14 and older.
18+	Adults only.

Canadian French ratings	
These ratings are based on the classification categories determined by La Régie du cinéma du Québec.	
G	General audiences.
8 ans+	Suitable for children 8 and older.
13 ans+	Suitable for children 13 and older.
16 ans+	Suitable for children 16 and older.
18 ans+	Adults only.

Adjusting the setup

To adjust the setup:

- 1 Press **MENU**. The *Main* menu opens.
- 2 Press **▲** or **▼** to highlight **Setup**, then press **ENTER** or **▶**. The *Setup* menu opens.



- 3 Press **▲** or **▼** to highlight an option, then press **◀** or **▶** to adjust or set the option. You can select:
 - **OSD Language**—Press the right or left arrow buttons to choose the OSD Language. Choices include **English**, **Spanish**, and **French**.
 - **Screen Mode**—Press the arrow buttons to choose the screen aspect ratio. Choices include **Normal**, **Wide**, or **Cinema to Zoom**.
 - **DPMS**—Use this setting with a computer monitor. When DPMS is on, the computer will control whether the screen is on or off. For example, if the computer is in sleep mode, the screen will be switched off. If the computer is activated, the screen also is activated.
 - **Time Setup**—Lets you set the exact time. You can also set up **Sleeper Time** and **Auto Sleep Time**.
 - **Caption**—Lets you set up closed captions. There are three options, including **Analog Closed Caption**, **Digital Closed Caption**, and **Digital Caption Style**.
 - **Analog Closed Caption**—CC1, CC2, CC3, CC4, TEXT1, TEXT2, TEXT3, and TEXT4.
 - **Digital Closed Caption**—Service1, Service2, Service3, Service4, Service5, and Service6.
 - **Digital Caption Style**—There are two digital caption styles. One is the automatic function set by the broadcaster, and the other is the custom style where you can adjust the font size, color, opacity, background color, and so on.
 - **Reset Default**—Resets the TV to its original factory settings.

Troubleshooting

Warning: Do not try to repair your TV yourself. Contact authorized service personnel.

Problem	Solution
Remote control	
Remote control does not work	<ul style="list-style-type: none"> • Replace the batteries. For more information, see "Installing remote control batteries" on page 7. • Make sure that the batteries are inserted correctly. For more information, see "Installing remote control batteries" on page 7. • Make sure that the power cord is plugged into an AC power outlet.
Video and audio	
No picture or sound (the screen is dark)	<ul style="list-style-type: none"> • Make sure that the power cord is plugged into an AC power outlet. • Press the POWER button to make sure that the TV is turned on. • Try another channel. The problem could be with the TV station.
Poor image quality in TV mode (such as a cutoff picture, snowy images) but the sound is good	<ul style="list-style-type: none"> • Make sure that the correct picture mode is selected. See "Adjusting the picture" on page 15. • Adjust the brightness. See "Adjusting the picture" on page 15. • Make sure the antenna or cable is connected correctly. See "Connecting an antenna, cable TV, or satellite TV box" on page 9. If necessary, rotate the antenna and wait up to ten seconds for a signal. • Replace poor antenna cables and/or connectors to improve signal quality.
No color, picture is dark, or color is not correct.	<ul style="list-style-type: none"> • Adjust the color saturation. See "Adjusting the picture" on page 15.
Only noise (snow) appears on the screen	<ul style="list-style-type: none"> • Make sure the antenna or cable is connected correctly. If necessary, rotate the antenna and wait up to ten seconds for a signal. See "Connecting an antenna, cable TV, or satellite TV box" on page 9. • Try another channel. The problem could be with the TV station.
The picture has dotted lines or stripes	<ul style="list-style-type: none"> • If necessary, rotate the antenna and wait up to ten seconds for a signal. • Move your TV away from noise sources, such as cars, neon signs, or hair dryers.
The picture has double images	<ul style="list-style-type: none"> • Try using a highly directional antenna or switch to cable or satellite TV.
The picture has a few bright or dark spots	<ul style="list-style-type: none"> • A few bright or dark spots is normal on an LCD screen. It does not affect the operation of this TV.
Good picture, no sound	<ul style="list-style-type: none"> • Try increasing the volume. • Press MUTE to make sure that the sound is not muted. • Make sure that the audio mode is set to STEREO or MONO. For more information, see "Adjusting the sound" on page 16.
Audio noise or static	<ul style="list-style-type: none"> • Move radio frequency communication equipment, such as a cordless phone, away from your TV.
General	
You cannot tune to one or more channels	<ul style="list-style-type: none"> • Make sure that the channels are not blocked by parental control settings. See "Setting parental controls" on page 17.
Your password is lost	<ul style="list-style-type: none"> • Open the Parental menu and reset the password. Enter "0532" to access the menu. See "Setting parental controls" on page 17.

Problem	Solution
You cannot access some items	<ul style="list-style-type: none"> If a setting or option is grayed out, it is not available in the current input mode.
The TV cabinet creaks	<ul style="list-style-type: none"> When you are using your TV, the temperature inside the cabinet increases. This causes the cabinet to expand or contract, causing the creaking noise. This is not a malfunction.
The buttons do not work	<ul style="list-style-type: none"> Unplug the power cord for a few seconds, then plug it back in and turn on your TV.

Notes:

If the problem is not solved by using these troubleshooting instructions, turn off your TV, then turn it on again.

Contact us by logging on to www.dynexproducts.com or by calling DYNEX Customer Service at (800) 304-2204 (USA and Canada only).

Maintenance

Just like with any other household appliance, the performance and life- expectancy of your TV depends on how well you maintain it. Follow the procedures described here to clean the TV case and the LCD screen.

Cautions:

- Make sure that the TV is turned off and the power cord is disconnected from the power outlet before cleaning the TV.
- Never spray or pour any liquid directly onto the screen or the case.

Cleaning

- Clean your TV with a soft, dry cloth. If surfaces are extremely dirty, use a soft cloth dampened with a small amount of non-ammonia, non-alcohol-based, mild, non-abrasive detergent.
- Clean the screen with a clean, soft, lint-free cloth. If additional cleaning is necessary, apply a small amount of non-ammonia, non-alcohol-based glass cleaner onto a clean, soft, lint-free cloth, then wipe the screen.

Specifications

Design and specifications are subject to change without notice.

Dimensions and weight are approximate.

TV model	DX-32L130A10
TV type	LCD
TV panel	31.5-inch TFT LCD
TV system	NTSC-M, ATSC

Channels	VHF: 2-13 UHF:-14-69 CATV: 1-125 CADTV: 1-135 DTV: 2-69 Audio multiplex BTSC system
Audio output	6 w x 2
Power requirement	AC 120 V~60 Hz
Power consumption	117 W
Dimensions	40 x 8.7 x 25.7 inches (100.5 x 22 x 65.3 cm)
Weight	35.3 lbs. (16 kg)
Audio/video input terminals	Composite video/left and right audio (1) S-Video (1) Component video/left and right audio (2) HDMI (2) VGA/audio (1) ANT/CABLE in (1)
Audio/video output terminals	Left and right audio Headphone jack (1) Digital coaxial audio (1)

Legal notices

FCC Part 15

This device complies with Part 15 of the FCC Rules. Operation of this product is subject to the following two conditions: (1) this device may not cause harmful interference, and (2) this device must accept any interference received, including interference that may cause undesired operation.

This equipment has been tested and found to comply within the limits for a class B digital device, pursuant to Part 15 of the FCC Rules. These limits are designed to provide reasonable protection against harmful interference in a residential installation. This equipment generates, uses, and can radiate radio frequency energy and, if not installed and used in accordance with the instructions, may cause harmful interference to radio communications. However, there is no guarantee that interference will not occur in a particular installation. If this equipment does cause harmful interference to radio or television reception, which can be determined by turning the equipment off and on, the user is encouraged to try to correct the interference by one or more of the following measures:

- Reorient or relocate the receiving antenna.
- Increase the separation between the equipment and receiver.
- Connect the equipment into an outlet on a circuit different from that to which the receiver is connected.
- Consult the dealer or an experienced technician for help.

FCC warning

Changes or modifications not expressly approved by the party responsible for compliance with the FCC Rules could void the user's authority to operate this equipment.

Canada ICES-003 statement

This Class B digital apparatus complies with Canadian ICES-003.

Standard Television Receiving Apparatus — Appareil de réception télévision ordinaire, Canada BETS-7 / NTMR-7

Notices

Specifications and features are subject to change without notice or obligation.

For service and support call (800) 305-2204.

One-year limited warranty

Dynex Products ("Dynex") warrants to you, the original purchaser of this new **DX-32L130A10** ("Product"), that the Product shall be free of defects in the original manufacture of the material or workmanship for a period of one (1) year from the date of your purchase of the Product ("Warranty Period"). This Product must be purchased from an authorized dealer of Dynex brand Products and packaged with this warranty statement. This warranty does not cover refurbished product. If you notify Dynex during the Warranty Period of a defect covered by this warranty that requires service, terms of this warranty apply.

How long does the coverage last?

The Warranty Period lasts for one year (365 days) from the date you purchased the Product. The purchase date is printed on the receipt you received with the Product.

What does this warranty cover?

During the Warranty Period, if the original manufacture of the material or workmanship of the Product is determined to be defective by an authorized Dynex repair center or store personnel, Dynex will (at its sole option): (1) repair the Product with new or rebuilt parts; or (2) replace the Product at no charge with new or rebuilt comparable products or parts. Products and parts replaced under this warranty become the property of Dynex and are not returned to you. If service of products and parts are required after the Warranty Period expires, you must pay all labor and parts charges. This warranty lasts as long as you own your Dynex Product during the Warranty Period. Warranty coverage terminates if you sell or otherwise transfer the Product.

How to obtain warranty service?

If you purchased the Product at a retail store location, take your original receipt and the Product to the store you purchased it from. Make sure that you place the Product in its original packaging or packaging that provides the same amount of protection as the original packaging. If you purchased the Product from an online web site, mail your original receipt and the Product to the address listed on the web site. Make sure that you put the Product in its original packaging or packaging that provides the same amount of protection as the original packaging.

To obtain in-home warranty service for a television with a screen 25 inches or larger, call 1-888-BESTBUY. Call agents will diagnose and correct the issue over the phone or will have an Dynex-approved repair person dispatched to your home.

Where is the warranty valid?

This warranty is valid only to the original purchaser of the Product in the United States, Canada, and Mexico.

What does the warranty not cover?

This warranty does not cover:

- Customer instruction
- Installation
- Set up adjustments
- Cosmetic damage
- Damage due to acts of God, such as lightning strikes
- Accident
- Misuse
- Abuse
- Negligence
- Commercial use
- Modification of any part of the Product
- Plasma display panel damaged by static (non-moving) images applied for lengthy periods (burn-in).

This warranty also does not cover:

- Damage due to incorrect operation or maintenance
- Connection to an incorrect voltage supply
- Attempted repair by anyone other than a facility authorized by Dynex to service the Product
- Products sold as is or with all faults
- Consumables, such as fuses or batteries
- Products where the factory applied serial number has been altered or removed

REPAIR REPLACEMENT AS PROVIDED UNDER THIS WARRANTY IS YOUR EXCLUSIVE REMEDY. DYNEX SHALL NOT BE LIABLE FOR ANY INCIDENTAL OR CONSEQUENTIAL DAMAGES FOR THE BREACH OF ANY EXPRESS OR IMPLIED WARRANTY ON THIS PRODUCT, INCLUDING, BUT NOT LIMITED TO, LOST DATA, LOSS OF USE OF YOUR PRODUCT, LOST BUSINESS OR LOST PROFITS. DYNEX PRODUCTS MAKES NO OTHER EXPRESS WARRANTIES WITH RESPECT TO THE PRODUCT, ALL EXPRESS AND IMPLIED WARRANTIES FOR THE PRODUCT, INCLUDING, BUT NOT LIMITED TO, ANY IMPLIED WARRANTIES OF AND CONDITIONS OF MERCHANTABILITY AND FITNESS FOR A PARTICULAR PURPOSE, ARE LIMITED IN DURATION TO THE WARRANTY PERIOD SET FORTH ABOVE AND NO WARRANTIES, WHETHER EXPRESS OR IMPLIED, WILL APPLY AFTER THE WARRANTY PERIOD. SOME STATES, PROVINCES AND JURISDICTIONS DO NOT ALLOW LIMITATIONS ON HOW LONG AN IMPLIED WARRANTY LASTS, SO THE ABOVE LIMITATION MAY NOT APPLY TO YOU. THIS WARRANTY GIVES YOU SPECIFIC LEGAL RIGHTS, AND YOU MAY ALSO HAVE OTHER RIGHTS, WHICH VARY FROM STATE TO STATE OR PROVINCE TO PROVINCE.

Contact Dynex:

For customer service please call 1-800-305-2204

www.dynexproducts.com

Distributed by Best Buy Purchasing, LLC

7601 Penn Avenue South, Richfield, Minnesota, U.S.A. 55423-3645

© 2009 Best Buy Enterprise Services, Inc.

All rights reserved. DYNEX is a trademark of Best Buy Enterprise Services, Inc. Registered in some countries. All other products and brand names are trademarks of their respective owners.

DYNEX™

www.dynexproducts.com (800) 305-2204

Distributed by Best Buy Purchasing, LLC
7601 Penn Ave. South, Richfield, MN 55423 U.S.A.

© 2009 Best Buy Enterprise Services, Inc. All rights reserved.

DYNEX is a trademark of Best Buy Enterprise Services, Inc. Registered in some countries. All other products and brand names are trademarks of their respective owners.

09-0617
ENGLISH



Free Manuals Download Website

<http://myh66.com>

<http://usermanuals.us>

<http://www.somanuals.com>

<http://www.4manuals.cc>

<http://www.manual-lib.com>

<http://www.404manual.com>

<http://www.luxmanual.com>

<http://aubethermostatmanual.com>

Golf course search by state

<http://golfingnear.com>

Email search by domain

<http://emailbydomain.com>

Auto manuals search

<http://auto.somanuals.com>

TV manuals search

<http://tv.somanuals.com>