

COBY®

CX-CD377

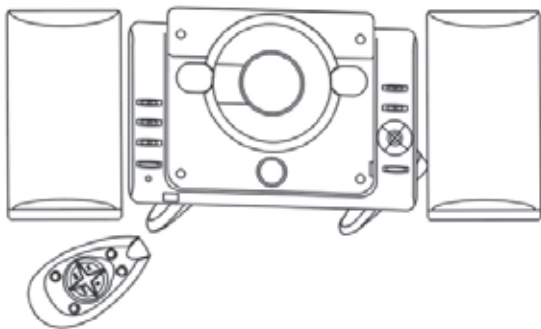

Micro CD Player Stereo System with AM/FM Tuner



INSTRUCTION MANUAL

Please read this manual carefully before operation.

PRECAUTIONS

	CAUTION WARNING: SHOCK HAZARD, DO NOT OPEN. AVIS: RISQUE DE CHOC ELECTRIQUE. NE PAS OUVRIIR	
CAUTION: TO REDUCE THE RISK OF FIRE AND ELECTRIC SHOCK, DO NOT REMOVE THE COVER (OR BACK) OF THE UNIT. REFER SERVICING ONLY TO QUALIFIED SERVICE PERSONNEL.		



The lightning flash with arrowhead symbol within an equilateral triangle is intended to alert the user to the presence of uninsulated "dangerous voltage" within the product's enclosure that may be of sufficient magnitude to constitute a risk of electric shock.



The exclamation point within an equilateral triangle is intended to alert the user to the presence of important operation and servicing instructions in the literature accompanying the appliance.

For Customer Use:

Enter below the serial number that is located on the unit. Retain this information for future reference.

Model No. _____ CX-CD377 _____

Serial No. _____

WARNING:

To prevent fire or shock hazard, do not expose this device to rain or moisture. Dangerous high voltage is present inside the enclosure. Do not open the cabinet.

CAUTION:

To prevent electric shock, match wide blade of plug to wide slot of outlet and fully insert.

WARNING:

Handling the cords on this product will expose you to lead, a chemical known to the State of California to cause cancer, and birth defects or other reproductive harm. **Wash hands after handling.**

PROTECT YOUR HEARING:

Hearing experts advise against the constant use of personal stereos played at high volume. Constant exposure to high volumes can lead to hearing loss. If you should experience ringing in the ears or hearing loss, discontinue use and seek medical advice.

PRECAUTIONS

CLASS 1 LASER PRODUCT

CLASS 1 LASER PRODUCT
APPAREIL LASER DE CLASSE 1
PRODUCTO LASER DE CLASE 1

CAUTION
INVISIBLE LASER RADIATION WHEN
OPEN AND INTERLOCKS DEFEATED.
AVOID EXPOSURE TO BEAM



This product contains a low power laser device.

ON PROTECTION AGAINST LASER ENERGY EXPOSURE

- ✦ As the laser beam used in this compact disc player is harmful to the eyes, do not attempt to disassemble the casing.
- ✦ Stop operation immediately if any liquid or solid object should fall into the cabinet.
- ✦ Do not put anything in the safety slot. If you do, the laser diode will be ON when the CD door is still open.
- ✦ If the unit is not to be used for a long period of time, make sure that all power sources are disconnected from the unit. Remove all batteries from the battery compartment, and unplug the AC-DC adapter from the wall outlet. Make it a practice to remove the AC-DC adapter by grasping the main body and not by pulling the cord.
- ✦ This unit employs a laser. The use of controls or adjustment or performance of procedures other than those specified here may result in exposure to hazardous radiation.

ON PLACEMENT

- ✦ Do not use the unit in places which are extremely hot, cold, dusty, or humid.
- ✦ Place the unit on a flat and even surface.
- ✦ Do not restrict the air flow of the unit by placing it in a place with poor ventilation, by covering it with a cloth, or by placing it on a carpet.

ON CONDENSATION

- ✦ When left in a heated room where it is warm and damp, water droplets or condensation may form inside the unit.
- ✦ When there is condensation inside the unit, the unit may not function normally.
- ✦ Let the unit stand 1 to 2 hours before turning the power on, or gradually heat the room up and dry the unit before use.

Should any trouble occur, remove the power source and refer servicing to qualified personnel.



For recycling or disposal information about this product, please contact your local authorities or the Electronics Industries Alliance: www.eiae.org.

IMPORTANT SAFETY INSTRUCTIONS

1. **Read Instructions:** All the safety and operating instructions should be read before the product is operated.
2. **Retain Instructions:** The safety and operating instructions should be retained for future reference.
3. **Heed Warnings:** All warnings on the product and in the operating instructions should be adhered to.
4. **Follow Instructions:** All operating and usage instructions should be followed.
5. **Cleaning:** Unplug this product from the wall outlet before cleaning. Do not use liquid cleaners or aerosol cleaners. Use a damp cloth for cleaning.
6. **Attachments:** Use only attachments recommended by the manufacturer. Use of other attachments may be hazardous.
7. **Water and Moisture:** Do not use this product near water (e.g., near a bath tub, washbowl, kitchen sink, laundry tub, in wet basements, or near a swimming pool and the like).
8. **Accessories:** Do not place this product on an unstable cart, stand, tripod, bracket, or table. Use only with carts, stands, tripods, brackets, or tables recommended by the manufacturer or sold with the product. Any mounting of the product should follow the manufacturer's instructions and should use a mounting accessory recommended by the manufacturer.
9. A product and cart combination should be moved with care. Quick stops, excessive force, and uneven surfaces may cause the product and cart combination to overturn.
10. **Ventilation:** Slots and openings in the cabinet are provided for ventilation to ensure reliable operation of the product and to protect it from overheating. These openings should never be blocked by placing the product on a bed, sofa, rug, or other similar surface. This product should not be placed in a built-in installation such as a bookcase or rack unless proper ventilation is provided or the manufacturer instructions have been adhered to.
11. **Power Sources:** This product should be operated only from the type of power source indicated on the rating label. If you are not sure of the type of power supply to your home, consult your product dealer or local power company. For products intended to operate from battery power or other sources, refer to the operating instructions.



IMPORTANT SAFETY INSTRUCTIONS

12. **Grounding or Polarization:** This product may be equipped with a polarized alternating-current line plug that has one blade wider than the other. This plug will only fit into the power outlet in one direction. This is a safety feature. If you are unable to insert the plug fully into the outlet, try reversing the direction of the plug. If the plug should still fail to fit, contact an electrician to replace the obsolete outlet. Do not defeat the safety purpose of the polarized plug.
13. **Power-Cord Protection:** Power supply cords should be routed so that they are not likely to be walked on or pinched by items placed upon or against them, paying particular attention to cords at plugs, convenience receptacles, and at the point which they exit from the product.
14. **Protective Attachment Plug:** The product may be equipped with an attachment plug with overload protection. This is a safety feature. See the operating instructions for replacement or directions to reset the protective device. If replacement of the plug is required, be sure the service technician has used a replacement plug that has the same overload protection as the original plug as specified by the manufacturer.
15. **Outdoor Antenna Grounding:** If an outside antenna is connected to the product, be sure the antenna system is grounded so as to provide some protection against voltage surges and built-up static charges. Article 810 of the National Electrical Code, ANS/NFPA 70 provides information with regard to proper grounding of the mast and supporting structure, grounding of the lead-in wire to an antenna-discharge unit, size of grounding conductors, location of antenna-discharge unit, connection to grounding electrodes, and requirements for the grounding electrode (see figure).

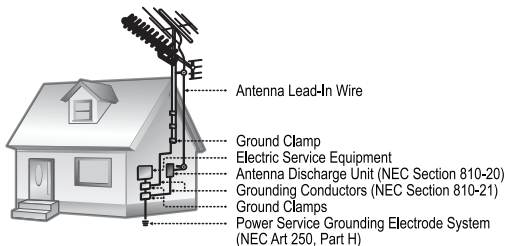

IMPORTANT SAFETY INSTRUCTIONS

16. **Lightning:** For added protection for this product, unplug it from the wall outlet and disconnect the antenna or cable system during a lightning storm or when it is left unattended and unused for long periods of time. This will prevent damage to the product due to lightning or power-line surges.
17. **Power Lines:** An outside antenna system should not be located in the vicinity of overhead power lines or other electric light or power circuits, or where it can fall into such power lines or circuits. When installing an outside antenna system, extreme care should be taken to keep from touching such power lines or circuits, as contact with them might be fatal.
18. **Overloading:** Do not overload wall outlets, extension cords, or integral convenience receptacles as this can result in a risk of fire or electric shock.
19. **Object and Liquid Entry:** Never push objects of any kind into this product through openings as they may touch dangerous voltage points or short-out parts that could result in a fire or electric shock. Never spill liquid of any kind on the product.
20. **Servicing:** Do not attempt to service this product yourself as opening or removing covers may expose you to dangerous voltage or other hazards. Refer all servicing to qualified service personnel.
21. **Damage Requiring Service:** Unplug this product from the wall outlet and refer servicing to qualified service personnel under the following conditions: a) when the power-supply or plug is damaged; b) if liquid has been spilled or if objects have fallen into the product; c) if the product has been exposed to rain or water; d) if the product does not operate normally by following the operating instructions. Adjust only those controls that are covered by the operating instructions as improper adjustment of other controls may result in damage and will often require extensive work by a qualified technician to restore the product to its normal operation; e) if the product has been dropped or damaged in any way; f) when the product exhibits a distinct change in performance—this indicates a need for service.
22. **Replacement Parts:** When replacement parts are required, be sure that your service technician has used replacement parts specified by the manufacturer or have the same characteristics as the original part. Unauthorized substitutions may result in fire, electric shock, or other hazards.
23. **Safety Check:** Upon completion of any service or repairs to this product, ask the service technician to perform safety checks to ensure that the product is in proper operating condition.

IMPORTANT SAFETY INSTRUCTIONS

24. **Wall or Ceiling Mounting:** The product should be mounted to a wall or ceiling only as recommended by the manufacturer.
25. **Heat:** The product should be situated away from heat sources such as radiators, heat registers, stoves, or other products (including amplifiers) that produce heat.

COMPLIANCE WITH FCC REGULATIONS

This equipment has been tested and found to comply with the limits for a Class B Digital Device, pursuant to Part 15 of the FCC Rules. These limits are designed to provide reasonable protection against harmful interference in a residential installation. This equipment generates, uses, and can radiate radio frequency energy and, if not installed and used in accordance with the instructions, may cause harmful interference to radio communications. However, there is no guarantee that interference will not occur in a particular installation. If this equipment does cause harmful interference to radio or television reception, which can be determined by turning the equipment off and on, the user is encouraged to try to correct the interference by one or more of the following measures:

- ✦ Reorient or relocate the receiving antenna.
- ✦ Increase the separation between the equipment and receiver.
- ✦ Connect the equipment into an outlet on a circuit different from that to which the receiver is connected.
- ✦ Consult the dealer or an experienced radio technician for help.

CD CARE & MAINTENANCE

Handling CDs

Hold a CD by its edges. Avoid touching the recorded side of the disc. To remove a CD from its storage case, press down on the center retention mechanism of the case and lift the disc out.

Cleaning CDs

Use a dry, soft cloth to wipe off any fingerprints and dusts from the playing surface of the disc. Wipe in a straight line radially from the center to the outside edge of the disc. Small dust particles and light stains will not affect playback quality.

- ✦ Never use chemicals such as record sprays, anti-static sprays, benzene, or thinners to clean your CDs.
- ✦ To reduce the risk of scratches, always put CDs back in their case after use.
- ✦ Do not subject CDs to prolonged exposure to direct sunlight, high humidity, or high temperatures.
- ✦ Do not place stickers or labels on either side of the CD.

Cleaning the CD Player Lens

A dirty lens can cause CD playback to skip. If the lens is very dirty, the CD may not work at all. Unplug the power supply, open the CD door, and clean the lens as follows:

- ✦ For Dust or Dry Particles - use a camera lens brush/blower to blow on the lens a few times. Then, wipe the lens gently with the brush, and blow on the lens once more.
- ✦ For Fingerprints - use a dry cotton swab to wipe the lens in a straight line radially from the center to the outside edge.

TABLE OF CONTENTS

PRECAUTIONS	2
IMPORTANT SAFETY INSTRUCTIONS	4
COMPLIANCE WITH FCC REGULATIONS	8
CD CARE & MAINTENANCE	9
Handling CDs.....	9
Cleaning CDs.....	9
Cleaning the CD Player Lens	9
TABLE OF CONTENTS	10
PACKAGE CONTENTS	12
FEATURES	13
GETTING STARTED	14
CX-CD377 at a Glance	14
Bottom View.....	15
Top View.....	15
Remote Control.....	15
Digital Display	15
Mounting the CX-CD377	16
Connections.....	17
Speakers	17
Auxiliary (optional).....	17
Power	17
CD MODE	18
Basic Operation	18
CD Functions	18
Play/Pause/Stop	18
Previous/Next (Skip).....	18
Reverse/Forward (Scan)	18
Repeat/Random Mode	19
Program (Memory).....	19
RADIO MODE	20
Basic Operation	20
Tuning.....	20
Reception.....	20

TABLE OF CONTENTS

AUX MODE	21
Basic Operation	21
SETUP MODE.....	22
Clock/Display.....	22
TROUBLESHOOTING.....	23
SPECIFICATIONS.....	25

PACKAGE CONTENTS

Please make sure the following items are included in the package. If any items are missing, contact your local dealer.

- + CX-CD377 Main Unit
- + Stereo Speakers (x 2)
- + Remote Control
- + 3.5mm male-to-male Line-in Cable
- + Mounting Plate with Screws (3 x 10 PWA)
- + Pedestal Base

FEATURES

- ✦ Vertical Loading CD Player
- ✦ Multi-Function Backlit LCD Display
- ✦ Electronic Volume Control
- ✦ Analog AM/FM Stereo Tuner (Rotary Tuning, Digital Readout)
- ✦ Dynamic Bass Boost System (DBBS)
- ✦ Full-Range Speaker System
- ✦ 110/220V Dual Voltage

GETTING STARTED

CX-CD377 at a Glance

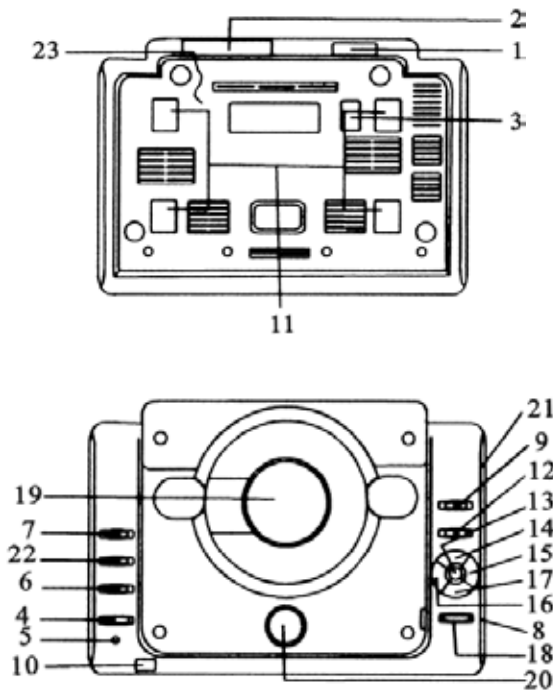

GETTING STARTED

Bottom View

1. AC Power Cord
2. Speaker Out Jacks (Left, Right)
3. Voltage Selector (110/220V)
11. Mounting Slots
23. FM Antenna Lead

Top View

4. Power (On/Off)
5. Power Indicator
6. Function Switch (CD/Aux/Radio)
7. Bass Switch (On/Off)
8. Auxiliary Line-In Jack
9. Volume Down / Up
VOLUME ▼ / **VOLUME ▲**
10. Remote Sensor
12. Play/Pause **▶||**
13. Stop **■**
14. Repeat/Random **REPEAT**
15. Next **▶▶**
16. Previous **◀◀**
17. Program **PROGRAM**
18. Open CD Door **OPEN**
19. CD Door
20. Digital Display
21. AM/FM Tuning Dial
22. Band Selector Switch (AM/FM/FM ST.)

Remote Control

1. Power/Standby
2. Program
3. Play/Pause
4. Stop
5. Next
6. Previous
7. Volume Up
8. Volume Down

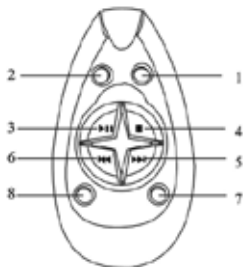

Digital Display



GETTING STARTED

Mounting the CX-CD377

To mount your CX-CD377 to either a wall or the pedestal base:

1. Using 4 screws, affix the mounting plate to either a wall or to the pedestal base.
2. Align the 4 mounting slots on the bottom of the main unit to hang on the hooks of the mounting plate.

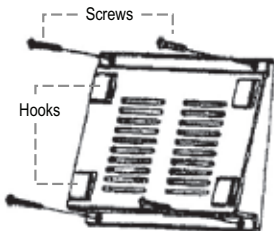

Mounting Plate



Pedestal with Mounting Plate

GETTING STARTED

Connections

Speakers

Always connect the speakers before connecting the power supply.

- ✦ Connect the black wire of the left speaker to the black terminal marked "L-" on the rear of the main unit.
- ✦ Connect the red wire of the left speaker to the red terminal marked "L+" on the rear of the main unit.
- ✦ Connect the black wire of the right speaker to the black terminal marked "R-" on the rear of the main unit.
- ✦ Connect the red wire of the right speaker to the red terminal marked "R+" on the rear of the main unit.

Auxiliary (optional)

- ✦ Use a 3.5mm male-to-male line-in cable to connect the line-out or headphone out jack of an audio device to the CX-CD377 Auxiliary Line-In jack.

Power

This unit runs on AC 110V or 220V power.

1. **Make sure that the voltage selector on the bottom of the unit is set to the proper voltage.** If you are unsure which voltage setting to use, please contact the local retailer from which you purchased this product.
2. Plug the power cord into an AC wall socket.
3. To turn the player on, set the POWER switch to the "On" position.





CD MODE

Basic Operation



1. Press POWER to turn the player on.
2. To open the CD Door, press **OPEN**. Insert a CD with its label facing up. Close the CD Door (it will click into place).
3. Set the FUNCTION switch to the "CD" position.
4. Press  to start CD playback.

CD Functions



Play/Pause/Stop

- + Press  to start playback.
- + Press  during playback to pause. Press  again to resume playback.
- + Press  during playback to stop the disc.

Previous/Next (Skip)

- + Press  to skip to the previous track.
- + Press  to skip to the next track.

Reverse/Forward (Scan)

- + Press and hold  to scan through the current track in a reverse direction.
- + Press and hold  to scan through the current track in a forward direction.

CD MODE

Repeat/Random Mode

Press **REPEAT** to set the repeat/random mode of the player. Each successive press of **REPEAT** will change the mode as follows:

- + Repeat One: repeat the current track (flashing REPEAT display)
- + Repeat All: repeat the entire CD (steady REPEAT display)
- + Random: play all tracks in random sequence (steady RANDOM display)
- + Normal/Off: play all tracks in sequential order (no indicator)

Program (Memory)

Press Program to set a custom sequence of up to 20 tracks to be played.

1. Press **STOP** to stop playback.
2. Press **PROGRAM** to enter Program mode.
3. Press **PREV** or **NEXT** to select a track and then press **PROGRAM** to store it in memory.
4. Repeat Step 3 until you have completed storing the program, or when you have stored 20 tracks.
5. Press **PLAY** to start program playback. To cancel program playback, press **STOP** or open the CD Door.

RADIO MODE

Basic Operation

1. Press POWER to turn the player on.
2. Set the FUNCTION switch to the "Radio" position.
3. Set the BAND SELECTOR switch to:
 - ✧ AM: Listen to AM broadcasts.
 - ✧ FM: Listen to FM Mono broadcasts (use this setting if reception is weak).
 - ✧ FM ST: Listen to FM Stereo broadcasts.

Tuning

- ✦ Turn the AM/FM Tuning Dial down to tune to a lower station frequency.
- ✦ Turn the AM/FM Tuning Dial up to tune to a higher station frequency.

Reception

- ✦ For FM broadcasts, extend the FM antenna fully and adjust its position for best reception.
- ✦ For AM broadcasts, the unit should be positioned for best signal strength (the AM antenna is built into the unit).

AUX MODE

Auxiliary (Aux) mode allows you to play any audio device (e.g., MP3, cassette player, etc.) through your CX-CD377 system.

Basic Operation

1. Use a 3.5mm male-to-male line-in cable to connect the Line-out or Headphone out jack of an audio device to the CX-CD377 Auxiliary Line-In jack.
2. Press POWER to turn the player on.
3. Set the FUNCTION switch to the "AUX" position.
4. Start playback on the external audio device.
 - ✧ You must use the external audio device to control playback
 - ✧ To avoid distortion, do not set the volume from the external audio device to very high levels.

SETUP MODE

Clock/Display

1. Place in the player in Standby mode (press POWER if the player is currently on). The time will be displayed when the player is in Standby.
2. Press **PROGRAM** to enter Setup mode. The 12H/24H setting will flash. Press **⏪** or **⏩** to change the setting.
 - ◇ 12H: Displays the time in 12-hour time.
 - ◇ 24H: Displays the time in 24-hour time.
1. Press **PROGRAM**. The hour setting will flash. Press **⏪** or **⏩** to change the setting.
2. Press **PROGRAM**. The minutes setting will flash. Press **⏪** or **⏩** to change the setting.
3. Press **PROGRAM** once more to save your changes.

TROUBLESHOOTING

If you have a problem with this device, please read the troubleshooting guide below and check our website at www.cobyusa.com for Frequently Asked Questions (FAQs) and firmware updates. If these resources do not resolve the problem, please contact Technical Support.

COBY Electronics Technical Support

Address: 56-65 Rust St.
Maspeth, NY 11378

Hours: Monday to Friday, 8:30 AM–11:00 PM EST
Saturday to Sunday, 9:00 AM–11:00 PM EST

Phone: 800-681-2629 or 718-416-3197

Email: techsupport@cobyusa.com

Web: www.cobyusa.com

There is no power to the device.

- ✦ Ensure that the power cord is securely connected to the unit and the proper wall outlet.
- ✦ Ensure that the voltage selector has been set properly (110V or 220V).

The device does not play.

- ✦ Moisture may have condensed inside the player. Remove the disc and leave the player on for 1-2 hours and then try again.

There is no sound.

- ✦ Ensure that the speaker connections are secure and correct.
- ✦ Try adjusting the volume.
- ✦ Ensure that the player is in the proper mode (CD, Aux, Radio).
- ✦ Ensure that headphones are not connected to the unit.

TROUBLESHOOTING

The sound is distorted.

- ✦ The unit may be positioned too closely to a large appliance (e.g, a TV or refrigerator). If possible, turn the appliance off or move the unit to another location.
- ✦ Ensure that the radio is in broadcast reception range.
- ✦ Decrease the volume level.

The remote control doesn't work.

- ✦ Ensure that there are no obstacles between the remote and the player.
- ✦ Point the remote at the remote sensor on the main unit.
- ✦ Strong light (e.g. direct sunlight, fluorescent lights, strobe lights) may interfere with the remote signal.
- ✦ Ensure that the batteries in the remote retain a charge and have been installed correctly.
- ✦ Try replacing the remote's batteries.

The CD will not play.

- ✦ Ensure that the CD has been loaded with its label facing up.
- ✦ Ensure that the CD is not damaged, scratched, or dirty.

Playback is "skipping".

- ✦ Ensure that the CD is not damaged, scratched, or dirty.
- ✦ Ensure that the unit has been installed in a stable location to avoid vibration and shock.

The player will only play one track, repeatedly.

- ✦ Ensure that REPEAT mode is off (press REPEAT to cancel).

The Function mode is not working.

- ✦ Ensure that the CD Compartment Lid is closed.

SPECIFICATIONS

Power Supply	AC 110/220V 60/50Hz (Dual Voltage)
Tuning System	AM: 530 - 1710kHz FM: 88 - 108MHz
Audio Output	Stereo Speakers (x2)
Audio Input	3.5mm Aux Line-In
Output Power	2.2W RMS x 2
Speaker Dimensions	4.33" x 8.07" x 6.38" (WHD)
Unit Dimensions	11.46" x 3.03" x 7.91" (WHD)
Net Weight	6.28 lbs

Specifications and manual are subject to change without notice.

NOTES

NOTES

COBY Electronics Corp.

56-65 Rust Street
Maspeth, NY 11378

www.cobyusa.com
www.ecoby.com

Free Manuals Download Website

<http://myh66.com>

<http://usermanuals.us>

<http://www.somanuals.com>

<http://www.4manuals.cc>

<http://www.manual-lib.com>

<http://www.404manual.com>

<http://www.luxmanual.com>

<http://aubethermostatmanual.com>

Golf course search by state

<http://golfingnear.com>

Email search by domain

<http://emailbydomain.com>

Auto manuals search

<http://auto.somanuals.com>

TV manuals search

<http://tv.somanuals.com>