

Compact 5.1-Channel Progressive Scan DVD Player

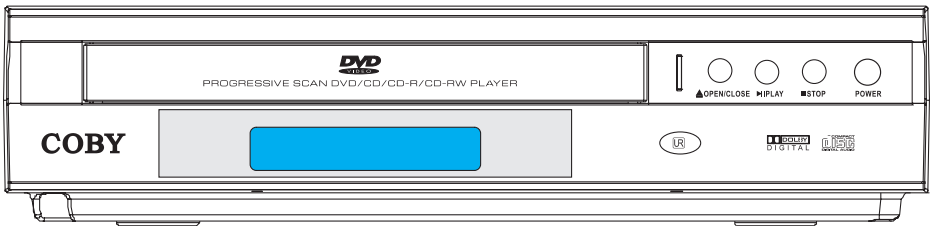

Instruction Manual

Please read this manual carefully before operation.

IMPORTANT SAFETY INSTRUCTIONS

1. Read these instructions carefully. Keep these instructions for future reference.
2. Heed all warnings and follow all instructions.
3. Do not expose to water or moisture.
4. Clean only with a dry cloth.
5. Keep objects away from ventilation openings. Do not block ventilation openings at any time.
6. Do not install near any apparatus that produces heat such as stoves, radiators, amplifiers, etc.
7. Do not force the power plug into a wall outlet. If the plug provided does not fit into your outlet, consult an electrician for replacement of the obsolete outlet. (A polarized plug has two blades where one is wider than the other; the wide blade is provided for your safety.)
8. Do not place heavy objects on the power cord. Protect the cord from being walked on, pinched by objects, or torn and exposed to liquids (especially at plugs, convenience receptacles, and the point at which they exit from the device).
9. Use only with attachments/accessories specified by the manufacturer. Use of attachments/accessories not recommended by the product manufacturer may be hazardous.
10. Unplug the device during lightning storms. Unplug the device and remove any batteries when the device will be unused for long periods of time.
11. Do not use this device near water. Do not place objects filled with liquids (e.g., vases) on the device. Never spill liquid of any kind on the device.
12. Never push objects of any kind into this device through openings as they may touch dangerous voltage points or short out parts that could result in a fire or electric shock.
13. Do not use headphones/earphones while cycling, driving, or operating a motorized vehicle.
14. Do not use headphones/earphones at high volume.
15. Do not drop or otherwise subject the device to impact.
16. Do not open or attempt to repair this device. Refer all repairs to authorized service personnel.
17. When replacements parts are required, be sure the service technician has used replacement parts specified by the manufacturer or that have the same characteristics as the original part. Unauthorized substitutions may result in fire, electric shock, or other hazards.
18. Upon completion of any service or repairs to this device, ask the service technician to perform safety checks to determine that the device is in proper operating condition.

Note:

The rating label is located on the rear panel of the device.

TABLE OF CONTENTS

PRECAUTIONS.....	2
IMPORTANT SAFETY INSTRUCTIONS	3
TABLE OF CONTENTS.....	4
ABOUT OPTICAL DISCS.....	6
Disc Requirements.....	6
Disc Care and Maintenance	6
Handling a Disc.....	6
Cleaning a Disc.....	6
FEATURES.....	7
LOCATION OF CONTROLS	8
Front Panel.....	8
Rear Panel	8
Remote Control.....	9
CONNECTIONS	10
Audio/Video Connections.....	10
Standard Television Set Connection	11
Progressive Scan Video Connection.....	11
Stereo Audio (2-Channel) Connection with Amplifier.....	12
Digital Audio (5.1-Channel Connection with Digital Decoding Amplifier.....	12
Remote Control.....	13
Power Supply	13
BASIC OPERATIONS	14
Basic Playback.....	14
Play/Pause/Stop	14
Previous/Next (Skip).....	14
Forward/Reverse (Search)	14
Slow	14
Menu Navigation	15
Numeric Keypad.....	15
Adjusting the Volume	15
Disc Error Messages	15
Power Management.....	15
PLAYER FUNCTIONS	16
Menu / Title	16
Setup.....	16
On-Screen Display.....	16
Search.....	16
DVD Chapter/Title Search	16
DVD Time Search (within a specified title).....	16
CD Time Search	16



TABLE OF CONTENTS

Repeat Mode.....	17
Repeat A-B Mode	17
Multi-Angle/Subtitle/Audio	17
Zoom	17
Program	17
DVD Program Mode.....	18
CD Program Mode.....	18
SETUP	19
Language Setup.....	19
Screen Setup	19
Audio Setup.....	20
Custom Setup	20
SPECIFICATIONS.....	21
TROUBLESHOOTING	22

ABOUT OPTICAL DISCS

Disc Requirements

This DVD player supports playback of the following discs.

Type	Disc Mark	Content Type	Disc Size	Max. Playback Time
DVD-Video Discs		Audio + Video (moving picture)	12 cm	133 min (SS-SL)
				242 min (SS-DL)
				266 min (DS-SL)
				484 min (DS-DL)
Audio Compact Discs (CDs)		Audio	12 cm	74 min
JPEG CDs	--	Still Picture	12 cm	--

This unit can play back CD-R and CD-RW discs that contain audio titles or JPEG picture files. Discs not listed above are not supported by this unit (e.g., PC CD-ROM, CD-Extra, CD-G, CD-I, etc.).

Disc Care and Maintenance

Optical discs (DVDs, CDs) contain high-density compressed data and need proper handling.

Handling a Disc

- Hold a DVD/CD by its edges. Avoid touching the recorded side of the disc. To remove a DVD/CD from its storage case, press down on the center retention mechanism of the case and lift the disc out.
- Do not subject discs to prolonged exposure to direct sunlight, high humidity, or high temperatures.
- Do not bend or press discs.
- To reduce the risk of scratches, always put discs back in their case after use. Store discs vertically in a cabinet.
- Do not place stickers or labels on either side of a disc.



Cleaning a Disc

Use a dry, soft cloth to wipe off any fingerprints and dusts from the playing surface of the disc. Wipe in a straight line radially from the center to the outside edge of the disc. Small dust particles and light stains will not affect playback quality.

- Never use chemicals such as record sprays, anti-static sprays, benzene, or thinners to clean a disc. Doing so will damage the surface of the disc permanently.

FEATURES

- Progressive Scan DVD Player
- Compact, Slim Design (2" High)
- Dolby Digital Decoder
- 5.1-Channel Output
- Digital, Optical, and Analog AV Outputs
- DVD, DVD±R/RW, CD, CD-R/RW, and JPEG Compatible
- NTSC/PAL Compatible
- Convenient Front Panel LCD and On-Screen Display
- Multiple Subtitles/Viewing Angles Supported
- Picture Zoom Function
- Parental Lock Control
- 100-240V Automatic Power Switching

LOCATION OF CONTROLS

Front Panel

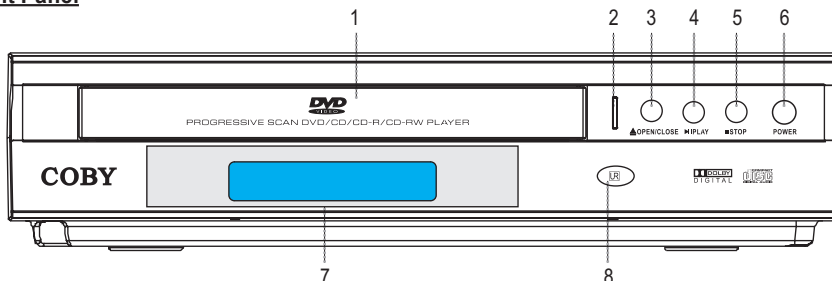

- | | |
|----------------------|--------------------------|
| 1. Disc Tray | 5. Stop button |
| 2. Power Indicator | 6. Power button |
| 3. Open/Close button | 7. Front Panel Display |
| 4. Play/Pause button | 8. Remote Control sensor |

Rear Panel

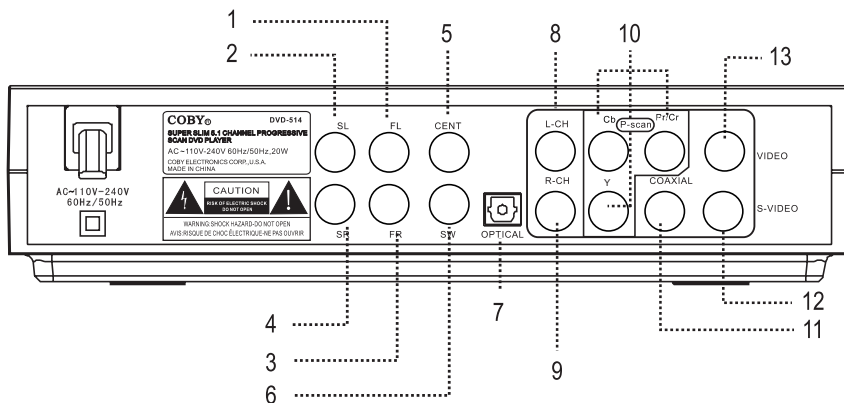

- | | |
|----------------------------|---|
| 1. Audio (Front Left) | 8. Audio (Left) |
| 2. Audio (Surround Left) | 9. Audio (Right) |
| 3. Audio (Front Right) | 10. Component Video Jacks
(Progressive Scan) |
| 4. Audio (Surround Right) | 11. Audio (Digital Coaxial) |
| 5. Audio (Center) | 12. S-Video Jack |
| 6. Audio (Subwoofer) | 13. Composite Video Jack |
| 7. Audio (Digital Optical) | |

LOCATION OF CONTROLS

Remote Control

1. STANDBY key
2. TITLE key
3. SUBTITLE key
4. MENU PBC key
5. AUDIO key
6. MUTE key
7. PROGRAM key
8. SETUP key
9. NAVIGATION keys
10. SLOW key
11. PLAY/PAUSE key
12. STOP key
13. FWD/REV keys
14. STEP key
15. VOLUME keys
16. ENTER key
17. P-SCAN key
18. ZOOM key
19. A-B key
20. REPEAT key
21. CLEAR key
22. NUMERIC keys
23. OPEN/CLOSE key
24. OSD key
25. ANGLE key

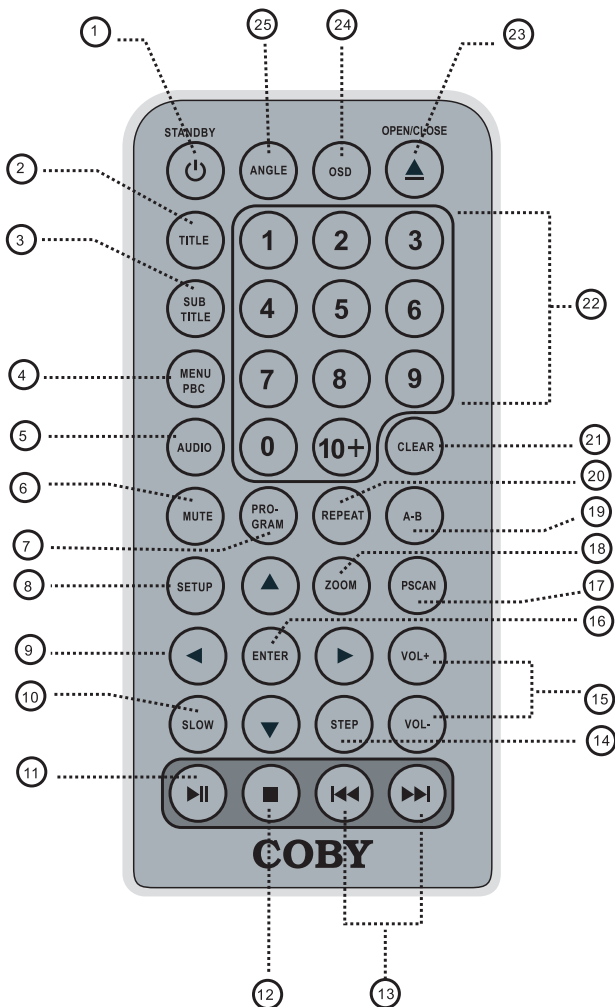

CONNECTIONS

Audio/Video Connections

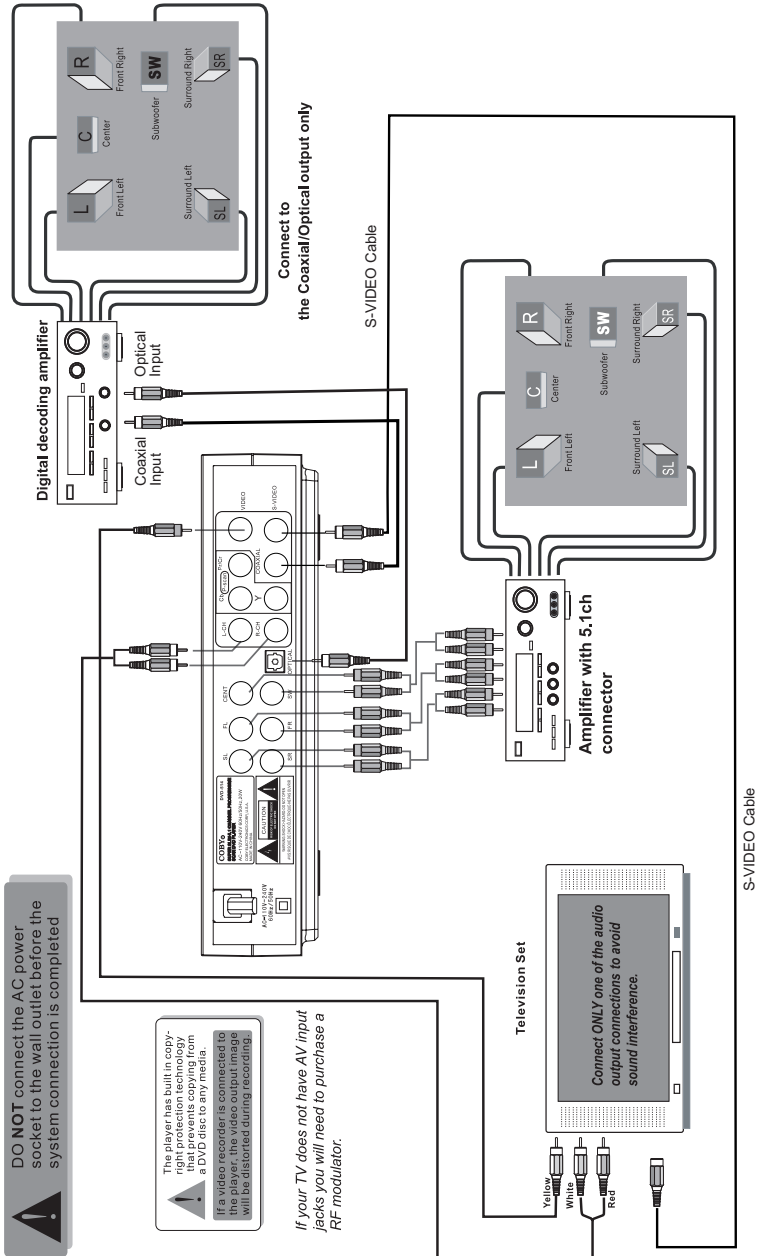

CONNECTIONS

Standard Television Set Connection

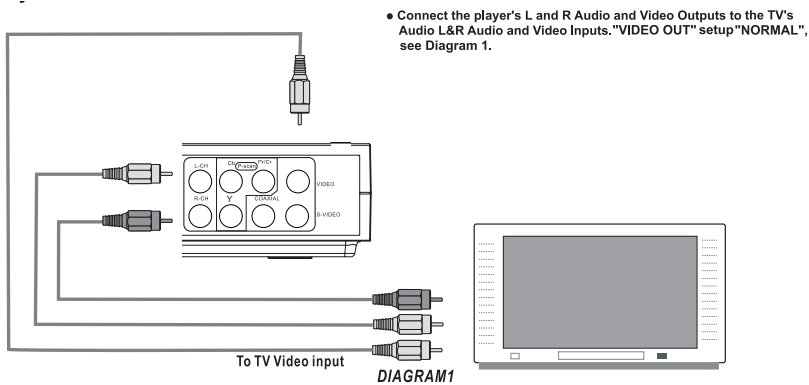

Progressive Scan Video Connection

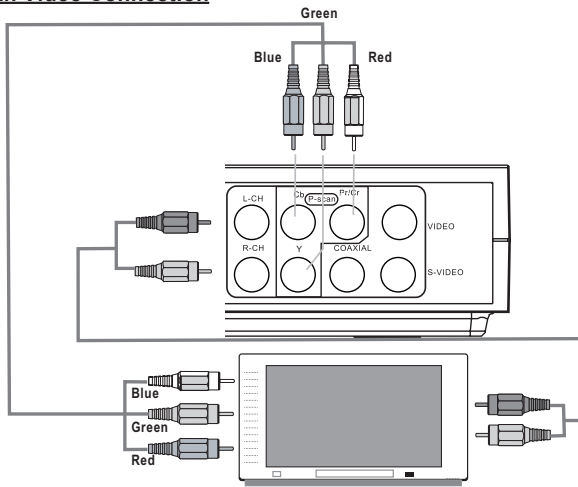

- 1 The player is equipped with composite A/V outputs at the rear of the player. Your TV will require at least one set of A/V inputs. The patch cord supplied with the player will connect your player's A/V output to your TV'S inputs.
- 2 Please remember to push the "Line" or "Input" or " Video/TV " button on your TV remote to view the DVD signal. Depending on your brand of TV, this button will have a different name for the same function, as per the examples above.

That function will allow your TV to be switched from the broadcast reception mode to one of the A/V signals. Some TVs have more than one A/V input.

- 3 The player is equipped for stereo playback. To fully realize 2 channel sound, a Stereo TV or A/V receiver is necessary. However, a Mono TV may be used providing the TV one set of A/V Inputs. The A/V input for Mono sound. You may connect either the Left or Right audio channel from the DVD Composite audio out to the mono TV audio input.

CONNECTIONS

Stereo Audio (2-Channel) Connection with Amplifier

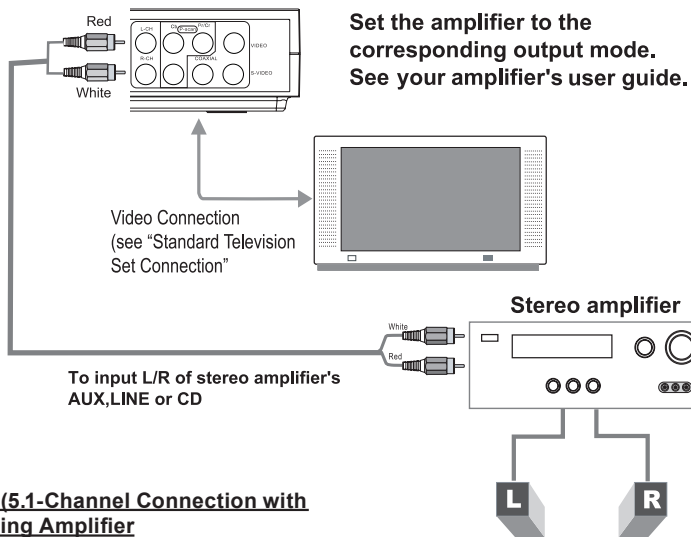

Digital Audio (5.1-Channel Connection with Digital Decoding Amplifier

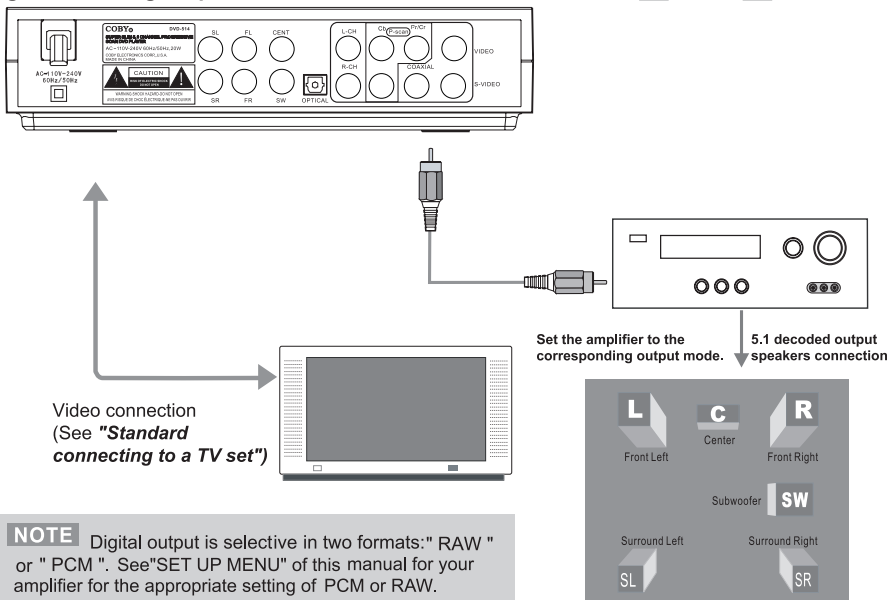

GETTING STARTED

Remote Control

- Refer to the diagram. Remove the battery compartment cover located on the rear of the remote control. Insert batteries, making sure to match their polarities (+/-) to the markings on the inside of the compartment. Replace the cover.
- To use the remote, point it at the remote sensor of the player. Operate the remote within 15 feet of the sensor and at an angle of +/- 60 degrees.
- Batteries in the remote will last for approximately 1 year. Replace the batteries if the remote control does not work. Do not mix old with new batteries, or different types of batteries.
- Remove the batteries from the remote if it will not be used for a long period of time.

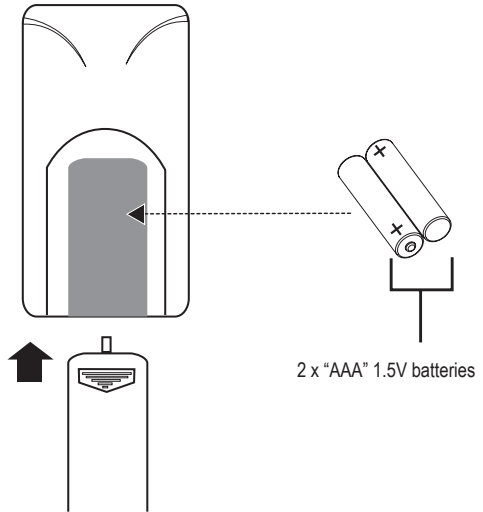

WARNING

- The batteries used in the remote control may present a fire or chemical burn if mistreated. Do not recharge, disassemble, incinerate, or heat the battery (~212°F).
- Keep batteries away from children.

Power Supply

This unit should be used with 100-240V 50/60Hz AC wall outlets, only.

Caution:







- *Do not connect the power plug to a power outlet other than that which is indicated here and on the label as this may result in the risk of fire or electric shock.*
- *Do not handle the power plug with wet hands. Doing so may cause electric shock.*

BASIC OPERATIONS



Basic Playback

1. Prepare the power supply.
Set the Power Switch to the ON position to turn the player on.
2. Load a disc.
Press the Open/Close button to open the disc tray. Insert a disc with the label-side up.
Press the Open/Close button again to close the disc tray.
 - If a single-sided disc is inserted upside-down, the player will display "NO DISC" or "BAD DISC".
3. Start playback.
Press PLAY to start playback (some discs may start playing automatically).

Play/Pause/Stop





- Press  to play the disc for the first time.
- Press  during playback to pause. Press  again to resume playback.
- Press  during playback to stop the disc ("Pre-Stop"). Press  to resume playback at the time-point at which the disc was stopped.
- Press  when the disc is "Pre-Stopped" to stop playback completely. (When  is pressed, the disc will start playing from the beginning.)

Previous/Next (Skip)

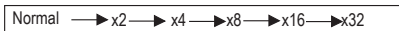
- Press  to skip to the next track (DVD, CD, etc).
- Press  to return to the previous track (DVD, CD, etc).



Forward/Reverse (Search)

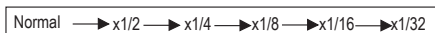

- Press  to change the rate of forward playback. Each successive press of  will change the rate of forward playback.
- Press  to change the rate of reverse playback through the disc. Each successive press of  will change the rate of reverse playback.

Slow



- Press SLOW for slow-motion playback. Each successive press of SLOW will change the rate of slow-motion playback. Press  to resume normal playback.
- Press STEP frame-by-frame playback. Each successive press of STEP will advance the video one frame. Press  to resume normal playback.

Note:

Audio will be muted during fast-forward, fast-reverse, and slow-motion playback.

BASIC OPERATIONS

Menu Navigation

To navigate DVD disc menus or the player's setup menus:

- Press the NAVIGATION keys (arrows) to select a desired feature or option in the menu.
- Press ENTER to confirm a selection in the menu.
 - For some menu options, you may be able to use the numeric keypad to input data.
- Press  to cancel an entry.

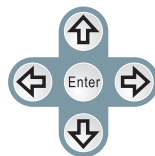

Numeric Keypad

- Use the numeric keypad to skip directly to a DVD chapter or CD track.
- Use the numeric keypad to input numeric data in menu option fields when possible.

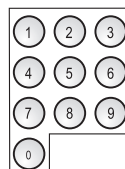

Adjusting the Volume

- Turn the Volume Control dial to adjust the volume level up or down.
- Press MUTE to turn the volume off completely; press mute again to restore the volume to its previous level.

Disc Error Messages

The following messages will be displayed on-screen if there is a problem with the format of the loaded disc.

- **WRONG REGIONAL DISC.** The region code of the disc does not match the player's region code (Region 1).
- **WRONG PASSWORD.** The parental rating level of the disc is higher than the parental rating level setting of the player. The player will not play the disc.
- **WRONG DISC.** The player is equipped with automatic disc quality detection software. If the player detects a disc that is damaged or has a format problem, it may play the disc at a lower quality or stop play completely, depending on how damaged the disc is.
- **DTS Discs:** This player does not have a built-in DTS decoder.
 - Connect to a digital amplifier using a Digital Audio Connection (optical or coaxial) to enjoy DTS audio discs.
 - Select Dolby 5.1 or 2-Channel Stereo Downmix instead of the DTS setting.

Note:

DVD disc production quality may vary; some discs may deviate from the industry standard. Some incorrectly-formatted discs may still play, however, the playback and operational quality of the disc may be substandard.

Power Management

If the player will not be in use for a long period of time, set the Power Switch to the OFF position, unplug the player, and remove the batteries from the remote control.

PLAYER FUNCTIONS

Menu / Title

- Press the MENU key during DVD playback to return to the DVD's Main menu.
- Press the TITLE key during DVD playback to return to the DVD's Title menu.

Setup

Press the SETUP key to enter the player's setup menu. Enter the Setup menu to adjust the player's internal settings; please see the SETUP section for more details.

On-Screen Display

Press the OSD key once to show time information on-screen; press it twice to show status information on-screen; press it a third time to exit the on-screen display mode. The on-screen display will disappear automatically if another function key is pressed.

Search

Press SEARCH to go directly to a desired point of a disc (e.g., Title, Chapter, Time).

DVD Chapter/Title Search

- Press SEARCH once to display the Chapter/Title Search Bar shown to the right.
- Press the left/right NAVIGATION keys to select (highlight) an entry field.
- Use the Numeric keypad to input the desired chapter/title number, or press the up/down NAVIGATION keys to increase/decrease the chapter/title number.
- Press ENTER to confirm and execute the search or press SEARCH to exit search mode.

DVD Time Search (within a specified title)

- Press SEARCH twice to display the Time Search Bar shown to the right.
- Use the Numeric keypad to input the desired time (hours, minutes, seconds).
 - Press CLEAR to cancel any input errors.
- Press ENTER to confirm and execute the search or press SEARCH to exit search mode.

CD Time Search

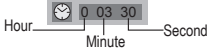
- Press SEARCH once to display the CD Time Search Bar shown to the right.
- Use the Numeric keypad to input the desired time (hours, minutes, seconds).
 - Press CLEAR to cancel any input errors.
- Press ENTER to confirm and execute the search or press SEARCH to exit search mode.

PLAYER FUNCTIONS

Repeat Mode

Press REPEAT to change the repeat mode of the player. Each successive press of REPEAT will change the mode as follows:

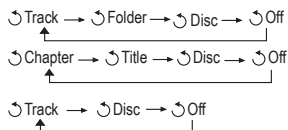

Note:

Some DVD discs do not allow Repeat mode.

Repeat A-B Mode

To repeat playback of a specific section of a disc (loop):

1. Press A-B to set the desired start point ("A") of the section to be repeated.
2. Press A-B again to set the desired end point ("B" of the section to be repeated.
3. The section "A-B" will now play repeatedly as a loop. Press A-B again to resume normal playback.

Multi-Angle/Subtitle/Audio

- During playback of a DVD that has been mastered with multiple angles, press ANGLE to view the available alternate camera angles. (A DVD may have up to 9 selectable angles.)
- During playback of a DVD that has been mastered with subtitles, press SUBTITLE to view the available subtitle tracks. (A DVD may have up to 32 selectable subtitles.)
- During playback of a DVD that has been mastered with alternate language/audio tracks, press AUDIO to hear the alternate tracks. (A DVD may have up to 8 selectable audio tracks.)

Zoom

Press ZOOM to change the magnification level of the picture.

- During DVD playback, each successive press of ZOOM will change the level of magnification to: Zoom 2x, Zoom 4x, Normal.
- During JPEG CD playback, each successive press of ZOOM will change the level of magnification to: 25%, 50%, 100%, 150%, 200%.

When the magnification level is greater than Normal/100%, use the NAVIGATION keys to pan around the magnified picture.

Note: *The picture quality will decrease as the zoom level increases.*

Program

Enter Program mode to create a custom sequence of tracks to be played.

(Program mode is available only when the player is in NAVIGATE OFF mode. Press the PBC key to set the player to NAVIGATE OFF mode.)

Note:

You can also use the numeric keypad to enter numbers directly in the fields. Use the navigation keys to move between entry fields.

PLAYER FUNCTIONS

DVD Program Mode

1. Load a DVD and press PROGRAM.
2. Press the right NAVIGATION key to select the "Title" column; press the up/down NAVIGATION keys to select a title.
3. Press the right NAVIGATION key to select the "Chapter" column; press the up/down NAVIGATION keys to select a chapter.
4. Press PLAY (or ENTER) to confirm the selection.
5. Repeat steps 2-4 until you have finished programming your selections or when you have programmed the maximum 20 tracks.
6. Press PLAY to start playback. Press PROGRAM to cancel.

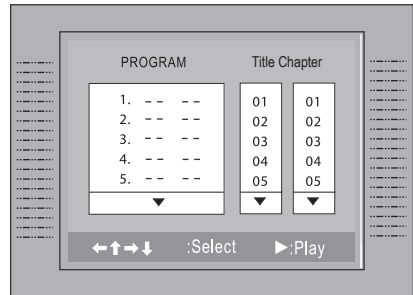

CD Program Mode

1. Load a CD and press PROGRAM.
2. Press the right NAVIGATION key to select the "Track" column; press the up/down NAVIGATION keys to select a track.
3. Press PLAY (or ENTER) to confirm the selection.
4. Repeat steps 2-3 until you have finished programming your selections or when you have programmed the maximum 20 tracks.
5. Press PLAY to start playback. Press PROGRAM to cancel.

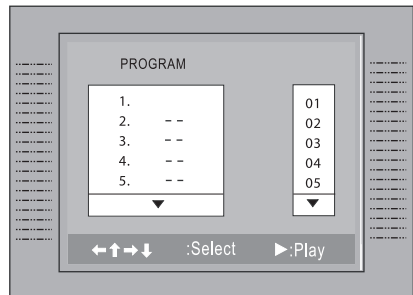

SETUP

Enter Setup mode to adjust the various internal settings of the player. Make sure the player has been completely stopped before entering Setup mode.

1. Press **SETUP** to enter Setup mode.
2. Use the **NAVIGATION** keys to select a desired item.
3. Press **ENTER** to confirm a selection.
4. Press **SETUP** to exit Setup mode (or select **EXIT** and press **ENTER**).

Language Setup

Use the **NAVIGATION** keys to highlight the desired language selection and press **ENTER** to confirm.

Item	Description	Options
OSD	Sets the language of the player's on-screen display.	English, French, German, Italian
Menu	Sets the default menu language of loaded DVDs.	English, Chinese, Japanese, French, German, Italian, Spanish, Portuguese, Hindi, Thai, Russian, Korean, Others
Audio	Sets the default language audio track of loaded DVDs.	English, Chinese, Japanese, French, German, Italian, Spanish, Portuguese, Hindi, Thai, Russian, Korean, Others
Subtitle	Sets the default subtitle track of loaded DVDs.	English, Chinese, Japanese, French, German, Italian, Spanish, Portuguese, Hindi, Thai, Russian, Korean, Others

Screen Setup

Use the **NAVIGATION** keys to highlight the desired screen selection and press **ENTER** to confirm.

Item	Description	Options
TV Type	Sets the aspect ratio of the display. (The TF-DVD7307 screen is 16:9.)	4:3 (PS), 4:3 (LB), 16:9
Screen Saver	The screensaver prevents burn-in damage to the player's screen.	On, Off
TV System	Sets the player's Video Out signal type. Set this to correspond with your TV.	NTSC, PAL, Auto
Brightness	Select a preset screen brightness.	Normal, Bright, Soft
Contrast	Adjust the screen's contrast.	-4 to +4 (0 is default)

SETUP

Audio Setup

Use the NAVIGATION keys to highlight the desired audio selection and press ENTER to confirm.

Item	Description	Options
Digital Out	Sets the player's Optical Out (audio) signal. For use with 5.1-channel receivers (see your receiver's manuals for more details).	SPDIF/RAW, SPDIF/PCM, Off

Custom Setup

Use the NAVIGATION keys to highlight the desired Custom Setup selection and press ENTER to confirm.

Item	Description	Options
Parental Ctrl	Sets the maturity rating level of the player. The player will not play any discs rated higher than this setting. <u>This setting is password protected (the default password is: 8888).</u>	Levels 1 to 8. (8: ADULT is default)
Password	Change the Parental Ctrl password. Enter the old password, the new password, and then the new password again to verify. DO NOT FORGET THE PASSWORD; this password cannot be reset.	
Angle Mark	Displays an on-screen prompt whenever an alternate angle becomes available for viewing (press ANGLE to view).	On, Off
Default	Resets all settings to their factory-default state. This will not reset the Parental Ctrl password.	Read

SPECIFICATIONS

Power Supply	AC: 100-240V Automatic Power Switching
Video Signal System	NTSC / PAL
Video Output	Component Video (Progressive Scan) S-Video RCA Composite Video
Audio Output	Optical Digital Out Coaxial Digital Out RCA Stereo Out
Media Supported	DVD, DVD±R/RW, CD, CD-R/RW, JPEG-CD
Accessories Included	Full Function Remote Control AV Cable
Unit Dimensions	8.86" x 2.0" x 10.43" (WHD)

Specifications are subject to change without notice.

TROUBLESHOOTING

If you have a problem with this player, please read the troubleshooting guide below and check our website at www.cobyusa.com for Frequently Asked Questions (FAQs) and firmware updates. If these resources do not resolve the problem, please contact Technical Support.

COBY Electronics Technical Support

Hours: Monday to Friday, 8:30 AM–11:00 PM EST
Saturday to Sunday, 9:00 AM–11:00 PM EST

Email: techsupport@cobyusa.com

Phone: 800-681-2629 or 800-727-3592 or 718-416-3197

Web: www.cobyusa.com

There is no power to the device.

- Ensure that the Power Switch is physically set to the ON position.
- Ensure that the AC adapter cord is securely connected to the player and the proper wall outlet.
- Ensure that the battery pack is fully charged.

The device will not play the disc.

- Ensure that a supported disc is loaded in the player label-side up.
- Ensure that the disc's rating level does not exceed the player's.
- Ensure that the disc is not damaged or too dirty. Clean the disc or try another disc.
- Moisture may have condensed inside the player. Remove the disc and leave the player on for 1-2 hours and then try again.

There is no picture.

- Ensure that the TV set has been powered on and is set to the correct AV mode.
- Ensure that the connections between the player and the TV are secure and correct.
- Check if the connection cables are damaged.

The picture is noisy or distorted.

- The disc may be damaged or dirty. Clean the disc or try another one.
- Reset your TV's color system.
- Ensure that the player is connected directly to the TV (and not through a VCR, cable box, satellite receiver, etc.)

There is no sound or distorted sound.

- Ensure that the TV and amplifier have been turned on and properly set up.
- Ensure that the TV and amplifier connections are secure and correct.
- Try a different Audio track of the DVD by pressing AUDIO.
- Ensure that the MUTE function of the TV, Amplifier, or Player is not engaged.

TROUBLESHOOTING

The remote control doesn't work.

- Ensure that the Power Switch has been physically set to the ON position.
- Ensure that there are no obstacles between the remote and the player.
- Point the remote at the remote sensor on the main unit.
- Ensure that the batteries in the remote retain a charge and have been installed correctly.
- Try replacing the remote's batteries.

The player has malfunctioned.

- Unplug the player. After 30 minutes, plug in and power on the player -- the restore function should reset the player.

COBY Electronics Corp.

56-65 Rust Street
Maspeth, NY 11378

www.cobyusa.com
www.ecoby.com

Free Manuals Download Website

<http://myh66.com>

<http://usermanuals.us>

<http://www.somanuals.com>

<http://www.4manuals.cc>

<http://www.manual-lib.com>

<http://www.404manual.com>

<http://www.luxmanual.com>

<http://aubethermostatmanual.com>

Golf course search by state

<http://golfingnear.com>

Email search by domain

<http://emailbydomain.com>

Auto manuals search

<http://auto.somanuals.com>

TV manuals search

<http://tv.somanuals.com>