

Cobra **MARINE™**



Black Box Fishfinder

MF 2500

Nothing Comes Close To A Cobra®

Owner's Manual

Printed in Italy
Part No. 406-300-P
Version A



www.cobra.com



MF 2500 FISH FINDER

Owner's Manual

All rights reserved. No part of this publication may be reproduced or distributed in any form or by any means, or stored in a database or retrieval system, without prior written permission of the publisher.

©2006 Cobra Electronics Corporation™
6500 West Cortland Street, Chicago
Illinois 60707 USA

©2006 Cobra® Electronics Europe Limited
Dungar House, Northumberland Avenue, Dun Laoghaire
County Dublin, Ireland

*Cobra®, NightWatch®, Nothing Comes Close to a Cobra® and the snake design are registered trademarks of Cobra Electronics Corporation, USA.
Cobra Electronics Corporation™, CobraMarine™ and iASAP™ are trademarks of Cobra Electronics Corporation, USA.*

(a051205)



Our Thanks to You and Customer Assistance

Introduction

Thank you for purchasing a CobraMarine™ MF 2500 Fish Finder. Properly used, this product will give you many years of reliable service.

How Your CobraMarine™ MF 2500 Fish Finder Works

The CobraMarine™ chartplotter combined with the sonar performance of the CobraMarine™ MF 2500 Fish Finder is one of the most advanced marine navigation system available. Please read this Owner's Manual carefully to learn the operation and installation features for your unit. Refer to your chartplotter Owner's Manual for all other software operating instructions.



Customer Assistance

CUSTOMER ASSISTANCE INFORMATION

Should you encounter any problems with this product, or not understand its many features, please refer to this Owner's Manual. If you require further assistance after reading this Owner's Manual, Cobra Electronics Corporation™ offers the following customer assistance services:

For Assistance in the U.S.A

Automated Help Desk English only.
24 hours a day, 7 days a week 773-889-3087 (phone).

Customer Assistance Operators English and Spanish.
8:00 a.m. to 6:00 p.m. through Fri. (except holidays) 773-889-3087 (phone).

Questions English and Spanish.
Faxes can be received at 773-622-2269 (fax).

Technical Assistance

English only: www.cobra.com (on-line: Frequently Asked Questions).
English and Spanish: productinfo@cobra.com (e-mail).

For Assistance Outside the U.S.A

Contact Your Local Dealer or Distributor. Please see www.cobra.com for contact information.



WARNINGS AND CAUTIONS

Before using your CobraMarine™ MF 2500 Fish Finder please read these general precautions and warnings.



CAUTION

- Please read through this manual before the first operation. If you have any questions, please contact the customer service or your local CobraMarine™ dealer or distributor.
- Extensive exposure to heat may result in damage to the MF 2500 Fish Finder.
- Connection to the power source with reversed polarity will damage the MF 2500 Fish Finder severely. This damage is not covered by the warranty.
- The MF 2500 Fish Finder contains dangerous high voltage circuits which only experienced technicians MUST handle.
- The MF 2500 Fish Finder is not built water proof. Please make sure to avoid water intrusion into the unit. Water damage is not covered by the warranty.



ABOUT THIS OWNER'S MANUAL

Any menu operations in this Owner's Manual are related to the CobraMarine™ Series of chartplotters. Connecting this product enables all of the Fish Finder menus and screens in the CobraMarine™ Series chartplotter.

WHAT IS IN THE BOX?

When the package containing the MF 2500 Fish Finder is first opened, please check it for the following contents (if any parts are missing contact the dealer the MF 2500 Fish Finder was purchased from):

- CobraMarine™ MF 2500 Fish Finder (with Power Serial and optional devices cables already connected)
- Owner's Manual



NOTE

The transducer is not included with this unit and can be ordered from your CobraMarine™ dealer.



1. MANUAL ORGANIZATION

1.1. TABLE OF CONTENTS

INTRODUCTION	2
OUR THANKS TO YOU	2
CUSTOMER ASSISTANCE INFORMATION	2
WARNINGS AND CAUTIONS	3
ABOUT THIS OWNER'S MANUAL	4
WHAT IS IN THE BOX?	4
1. MANUAL ORGANIZATION	5
1.1. TABLE OF CONTENTS	5
1.2. OVERVIEW	6
2. THE MF 2500 FISH FINDER	7
2.1. TECHNICAL SPECIFICATIONS	7
2.2. DIMENSIONS	8
2.3. MOUNTING THE FISH FINDER	8
2.3.1 Installation	9
2.3.2 Installing Optional Devices	9
2.4. STATUS LED	9
2.5. EXTERNAL CONNECTIONS	11
2.6. POWER SUPPLY WIRING DIAGRAM	12
2.7. CHARTPLOTTER CONNECTION DIAGRAM	13
3. TRANSDUCERS	14
4. FREQUENTLY ASKED QUESTIONS	16



1.2. OVERVIEW

The Fish Finder consists of a high power transmitter, sensitive receiver and a transducer. The Fish Finder sends an electrical pulse to the transducer which contains an element that converts the pulse into acoustic (sound) wave which is sent through the water. As this wave travels from the transducer to the bottom, it may strike fish, structures, thermoclines (temperature changes in the water, etc.). When the wave strikes an object(s) a certain amount of the wave is reflected back to the transducer depending on the composition and shape of the object. When the reflected wave is returned to the transducer it is converted into an voltage and is amplified by the receiver, processed and sent to the display. The speed of sound in water is roughly 4800 ft./sec, so the time lapse between the transmitted signal and the received echo can be measured and the distance to the object determined.

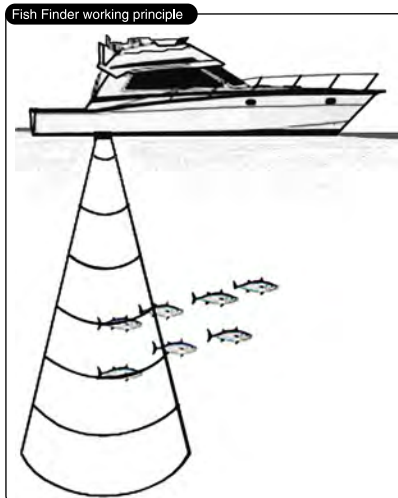



2. THE MF 2500 FISH FINDER

2.1. TECHNICAL SPECIFICATIONS

- Display Colors : 16 colors
- Display Vertical Resolution : up to 400 pixels (depending on chartplotter screen resolution)
- Power Requirements : 10 - 35 Volt dc
- Over Voltage protection
- Reverse Polarity protection
- Power Consumption - operating: 17W max
- Power Consumption - stand by : 1.7W max
- Operating Frequency : Dual 50 and 200kHz
- Output Power : 500 or 1000W (4000 or 8000Wpp)
- Depth Range
 - 1KW/200kHz : 2.5 Ft (0.8m) to 1200Ft (365m)
 - 1KW/50kHz : 5 Ft (1.6m) to 4000Ft (1219m)
 - 500W/200kHz : 2.5 Ft (0.8m) to 700Ft (213m)
 - 500W/50kHz : 5 Ft (1.6m) to 1500Ft (457m)
- Status LED
- External Buzzer : 12VDC, 400mA
- Speed Sensor : if available on transducer
- Temperature Sensor : one channel TEMP1 (if available on transducer), optional second channel TEMP2
- NMEA Output sentences : Depth: \$SSDDPT, \$SSDBT
Speed: \$VWVHW
Trip Log: \$VWVLW
Water Temperature: \$YXMTW
TEMP2 Temperature: \$YXXDR
- Operating temperature range : 0C to +50C
- Storage temperature range : -20C to +70C
- Weight : 1 kg (2,20 LBS)
- Water Proof Specification : IP 54
- Case Size : 7.62" (193.30mm) x 6.87" (174.30mm) x 2.19" (55.50mm)



Mounting the Fish Finder

Installation

2.3.1 Installation

Picture showing actual example of the MF 2500 Fish Finder installation.

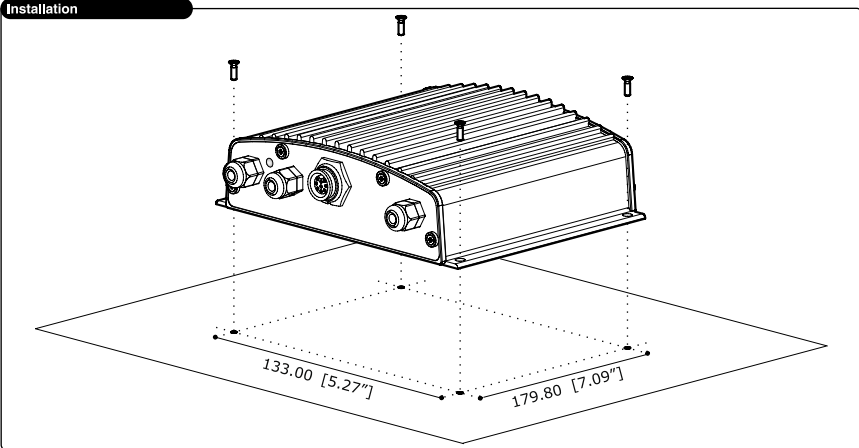

- Fix the MF 2500 Fish Finder to the mounting location using the four screws (holes diameter 4 mm), see previous picture.
- Route the CHARTPLOTTER cable to the CobraMarine™ chartplotter.
- Mount the transducer according to the instructions provided with it.
- Connect the POWER cable to the battery. Please be advised that the MF 2500 Fish Finder when not operating will remain in Stand-By mode.

2.3.2 Installing Optional Devices

See the External Connection diagram in Par. 2.5.

2.4 STATUS LED

There are seven different LED behaviors, representing seven different diagnostic conditions. These are described below.

- 1. BOOTLOADER
LED Behavior: OFF
The MF 2500 Fish Finder is running in the bootloader, or is not powered on at all.
- 2. STANDALONE DST, NO TRANSDUCER MODE
LED Behavior: ON, steady



The MF 2500 Fish Finder is in Standalone DST (Depth, Speed, Temperature) mode, but is not pinging because Transducer ID has not detected a transducer. This condition will occur if there is no communication with the chart plotter, and no transducer is connected.

■ 3. STANDALONE DST

LED Behavior: 1 long flash every 2 seconds

The MF 2500 Fish Finder is in Standalone DST mode, and is pinging normally. This condition will occur if a transducer is connected properly, but there is no communication with the chart plotter. In Standalone DST mode, the NMEA 0183 output produces standard NMEA Depth, Speed, and Temperature sentences.

■ 4. NORMAL FISH FINDER MODE

LED Behavior: 1 short flash every 2 seconds

The MF 2500 Fish Finder and the transducer are operating properly. This is the normal behavior when everything is working.

■ 5. WAITING FOR COMMAND

LED Behavior: 2 short flashes every 2 seconds

The MF 2500 Fish Finder is not pinging because it is waiting for a command from the chart plotter.

■ 6. LOW POWER MODE

LED Behaviour: 3 short flashes every 2 seconds

The MF 2500 Fish Finder has detected a transducer without transducer ID, but the "ignore" command has been selected on the chart plotter so the unit is pinging at low power.

■ 7. NO TRANSDUCER MODE

LED Behavior: 4 short flashes every 2 seconds:

The MF 2500 Fish Finder is not pinging because transducer ID has not been detected a transducer and the "ignore" command has not been selected on the chart plotter.



External Connections

Installation

2.5 EXTERNAL CONNECTIONS

External Connections

POWER Cable

Terminal strip	Cable color	Function
D	Black	GND
E	Red	Power supply 10-35 VDC

OPTIONAL DEVICES Cable

Terminal strip	Cable color	Function
F	Black	GND
G	Green	NMEA B(-)
H	White	NMEA A(+)
I	Yellow	TEMP 2(+)
L	Black	GND
M	Blue	ALARM Output(+)
	Red	Not connected
	Gray	Not connected
	Brown	Not connected
	Orange	Not connected
	Pink	Not connected

TRANSUDCER Connector

Pin	Function
1	DEPTH +
2	GND
3	TEMP1 +
4	POWER SUPPLY +5Vdc, 1A max.
5	SENSE +
6	DEPTH SHIELD
7	DEPTH -
8	SPEED +

CHART PLOTTER Cable

Terminal strip	Cable color	Function	Chart Plotter Function
A	Brown	FF TX+	Input2+
B	Gray	FF RX+	Output2+
C	Black	FF GND	GND

Diagram: A diagram showing a Female 8 Pin connector on the left, labeled "Chart Plotter". It is connected to a Male 8 Pin connector on the right, labeled "Power & I/O cable of Chart Plotter". The pins are numbered 1 through 8 on both sides.



2.6 POWER SUPPLY WIRING DIAGRAM

We recommended the installation of a switch and a (5A) fuse in the positive DC supply to the MF 2500 Fish Finder. The MF 2500 Fish Finder is active sending the digital depth through the NMEA interface even when the power (chartplotter) is turned off, thus the need for a switch.

In the example below you will notice the positive DC power connection is run through a switch and a fuse before connecting it to the MF 2500 Fish Finder and the chartplotter.

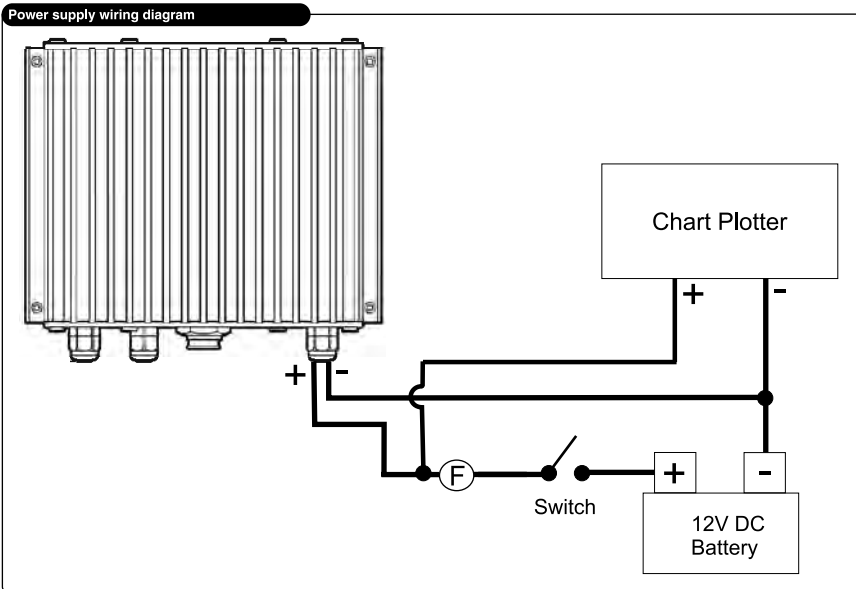



Chartplotter Connection Diagram

2.7 CHARTPLOTTER CONNECTION DIAGRAM

See the following picture to make the connection to the chartplotter:

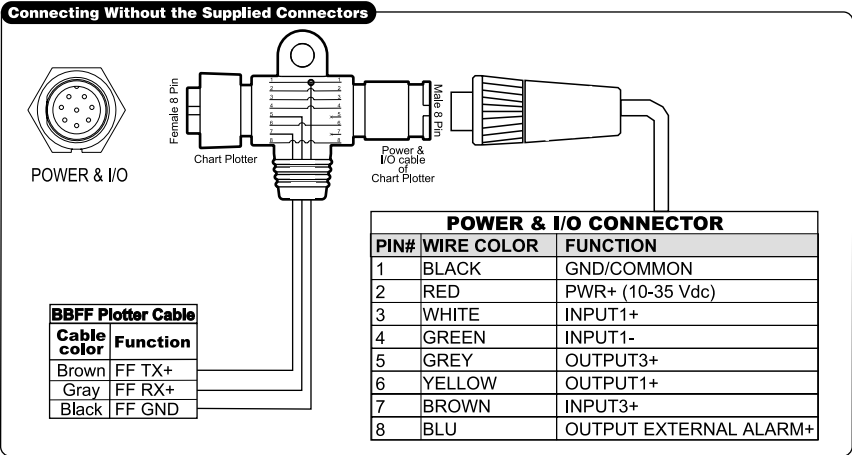



3. TRANSDUCERS

The transducer is a device that transmits and receives sound waves into the water. The active component inside the transducer is commonly referred to as an element but actually is a piezoelectric ceramic material.

CobraMarine™ sells 4 transducers for various applications. See the table below

Part Number	CM 610-001	Part Number	CM 610-002
Description	Transom Mount. Dual Frequency 50/200, Depth, Speed, Temp, 500 Watt max	Description	Bronze Through Hull Triducer, Dual Frequency 50/200, Depth, Speed, Temp, 500 Watt Max, With Fairing Block
Usage	Mounted on the transom of the boat for Outboard and Sterndrive (I/O), and other installations	Usage	Used for Inboard, Sailboat, Commercial and High Performance applications
			
Part Number	CM 610-003	Part Number	CM 610-007
Description	In-Hull (shoot through) with adjustable base, Dual Frequency 50/200, Depth Only, 500 Watt Max	Description	Auxiliary Temperature Transducer, Transom or Livewell
Usage	Solid Fiberglass Hull without airpockets. Depth only installation but can be mid season install without hauling	Usage	Secondary Temperature Sensor. Can be used to measure Livewell, Water or Air Temperature
			



Transducers

Installation

Please contact your **AIRMAR** transducer dealer for other available transducer configurations. There are many unique options available for your installation:



NOTE

Only some transducer models are suitable for 1000 Watt operation. Airmar has several suitable models. The MF 2500 Black Box Fish Finder will operate at this higher power rating if one of these transducers is connected.



4. FREQUENTLY ASKED QUESTIONS

4.1 How can I disconnect the cables from the MF 2500 Fish Finder in case I need to do so for the installation?

- Open the MF 2500 Fish Finder box unscrewing the four screws (see the following figure).

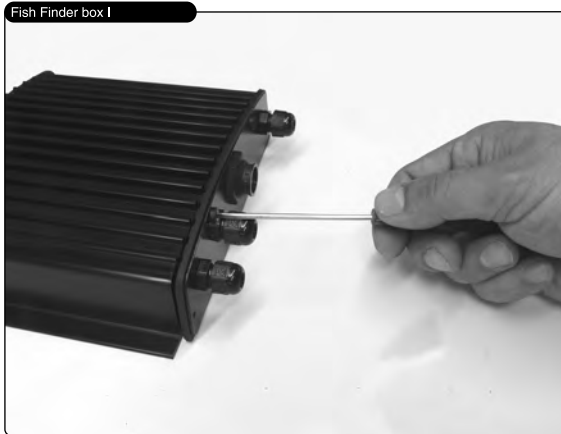

- Once the screws are removed, pull out the panel and the Printed Circuit Board (PCB). Unscrew the cables from the PCB.

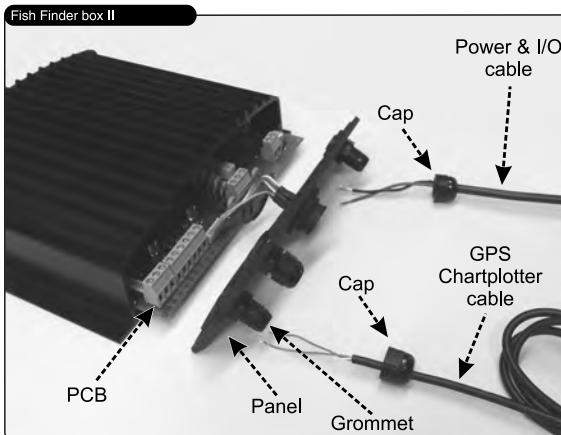

- Wire the cables as needed.



- Reconnect the cables to the PCB.
- Push the panel towards the case (be sure to have well positioned the rubber gasket). Close the MF 2500 Fish Finder box screwing the four screws.

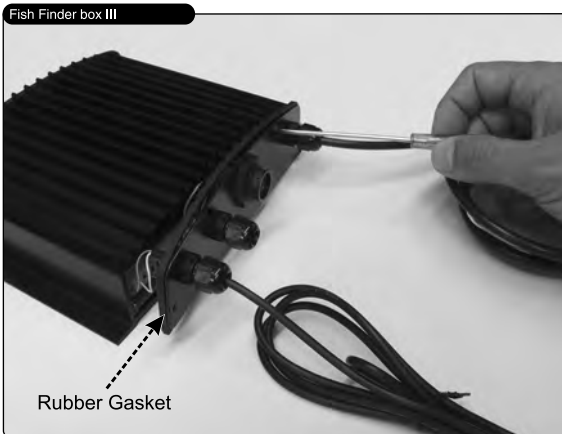

4.2 How can I set optimal operating parameters.

Optimal operating parameters can be set accordingly with the intended use of the Fish Finder. To quickly set get optimal operational parameters for fishing it is possible to select the FISH preset from the Fish Finder Setup menu, while for cruising it is possible to select the CRUISE preset.

4.3 What are preset modes?

Preset modes are pre-defined settings of the Fish Finder operating parameters. There are five preset. You can use them to quickly set the Fish Finder in the most commonly used operating modes. These are:

- CRUISE: sets the Fish Finder in full auto mode with the sensitivity settings (GAIN OFFSET, NOISE level and STC) optimized for displaying at best the bottom.
- FISH: sets the Fish Finder in full auto mode with the sensitivity setting optimized for target searching.
- AUTORANGE: sets the autorange mode and the manual gain mode.
- BOTTOM LOCK: sets the range mode to bottom lock and the manual gain mode.
- MANUAL: sets the range mode and the gain mode to manual.



4.4 How can I restore the Fish Finder default operating parameters?

Simply select the CRUISE or the FISH preset. This will restore optimal operating parameters for either cruising or fishing.

4.5 I'm using the Fish Finder in manual mode, how can I set the parameters for optimal operation.

Setting operating parameters for optimal operation depends upon environment conditions, user preference and intended usage of the Fish Finder (e.g. fishing or cruising). A good starting point is to select a full auto preset such as CRUISE or FISH and then, after waiting a while to allow the echogram displayed to stabilize around the auto calculated parameters, switch to the MANUAL preset mode. At this point it will be possible to fine tune the operating parameters by slightly changing the auto calculated parameters.

4.6 Can I always leave the Fish Finder in Full Auto/(auto gain and auto range) mode?

Yes, but note that the full auto mode suits the 90% of the cases, however in extreme situations the auto modes may fail and thus it is necessary to switch to the Manual mode.

4.7 What are extreme situations in which auto modes may fail?

When the bottom is very deep, at high boat speed, when the bottom is very shallow (< 5 feet), when the water is full of materials in suspension, or bad sea conditions.

4.8 What should I do if the auto modes fail?

Failure of auto modes can happen for various reasons. You can find a range of possibilities below.

4.8.1 Auto-range fails in very shallow waters displaying a digital depth readout deeper than the actual value. What should I do?

This usually happens if the STC is set to LONG or MID and the bottom is shallow or SHORT if the bottom is very shallow causing the auto-range to hook to the second or third echo from the bottom (since in shallow waters the sound bounces more times back and forth the surface to the bottom). Try



decreasing the STC value to SHORT in shallow waters or to switch it to VERY SHORT or OFF.

4.8.2 Auto range fails, and the digital depth readout displays a very shallow reading. What should I do?

This usually happens if the STC is off or is set to a low value causing disturbs from surface clutter to be stronger than bottom echoes. Try increasing the STC value. As general rule STC has to be set as in shallow waters and LONG in depth waters.

4.8.3 Auto-range fails in very deep waters displaying a digital very shallow depth readout. What should I do?

The Fish Finder capability to detect the bottom decreases as the bottom depth increase. If the bottom composition is soft as mud, if the sea conditions are bad, if there are thermoclines or the water is full of materials in suspension it can further decrease thus causing the digital depth readout to fail. When this happens the auto-range algorithm also fails. To recover from this situation it is necessary to switch to manual range mode and to set the manual depth mode. When manual depth mode is selected the algorithm that calculates the digital depth readout searches for the bottom within the range manually selected by the user. At this point it is necessary to increase manually the range until the bottom becomes graphically visible. If the echoes from the bottom are strong enough, the Fish Finder shall look to the bottom giving a correct depth reading and shall be possible to return in auto range mode. Please note that if one or more of the conditions that reduce the echoes from the bottom listed above is true the bottom may be not visible at all, in this situation a strong thermocline or surface clutter may be interpreted by the Fish Finder as the bottom.

4.9 At a very shallow range upper half of the screen appears almost completely filled by the surface clutter. How can I eliminate it?

This is normal in shallow waters. To clean up the surface clutter without degrading the digital depth readout algorithm functionality it is possible to set the STC value to custom setting the STC lenght to the same size of the surface clutter, and increasing the STC strenght until the image on the screen cleans up. Please note that in very shallow waters it is usually better to switch to manual gain mode to reduce gain fluctuation due to rapidly changing bottom conditions.



4.10 Why do I never see fish in the range between 0 to 0.7 meters?

The minimum range of the fish finder is 0.7 meters. In this interval the Fish Finder can detect neither the bottom nor any target.

4.11 How can I reduce the surface clutter?

You can act by: properly setting the STC as described at 6.12 and also by increasing the NOISE LEVEL and reducing the GAIN or the GAIN OFFSET (if you are in auto gain mode). However please note that a strong attenuation of surface clutter may also reduce the capability to detect targets.

4.12 The Fish Finder is in auto gain mode but the picture display too many small targets, what shall I do to reduce the screen clutter?

Try increasing the NOISE LEVEL or decreasing the GAIN OFFSET.

4.13 In very shallow waters when the AUTO GAIN mode is selected there are fluctuations in the bottom profile width and its color representation. What should I do?

In very shallow waters the environment situation (bottom/water condition) vary very quickly thus causing the auto gain algorithm to create oscillations while trying to set optimal GAIN value for each situation. To avoid this it is advisable to switch to MANUAL GAIN mode and fine tune the GAIN to a fixed setting.

4.14 In very deep waters even setting the GAIN to its maximum value I cannot see the bottom what shall I do?

Try decreasing the NOISE LEVEL. If the bottom is still not visible, there is nothing you can do, the bottom echo is simply too weak to be detected.



INDEX

A	
ASSISTANCE	2
C	
Case Size	7
CONNECTION DIAGRAM	13
connection to chartplotter	13
D	
Depth Range	7
DIMENSIONS	8
Display Colors	7
Display Vertical Resolution	7
E	
External Buzzer	7
EXTERNAL CONNECTIONS	11
F	
Fish Finder	6
I	
Installation	9
L	
LED	9
N	
NMEA Output sentences	7
O	
Operating Frequency	7
Operating temperature range	7
Output Power	7
Over Voltage protection	7
OVERVIEW	6
P	
package	4
Power Consumption	7
Power Requirements	7
POWER SUPPLY	12
Q	
Questions	16
R	
Resolution	7
Reverse Polarity protection	7
S	
Speed Sensor	7
STATUS LED	9
Status LED	7
Storage temperature range	7
T	
TECHNICAL SPECIFICATIONS	7
Temperature Sensor	7
transducer	6, 15
W	
warnings	3
Water Proof Specification	7
Weight	7

**The Cobra Electronics Corporation™
line of quality products includes:**

CB Radios

microTALK® Radios

Radar/Laser Detectors

Safety Alert® Traffic Warning System

Handheld GPS Receivers

Mobile GPS Receivers

HighGear® Accessories

CobraMarine™ VHF Radios

CobraMarine™ GPS Chartplotters

Power Inverters

Accessories

**For more information or to order
any of our products, please visit our
website: www.cobra.com**

Free Manuals Download Website

<http://myh66.com>

<http://usermanuals.us>

<http://www.somanuals.com>

<http://www.4manuals.cc>

<http://www.manual-lib.com>

<http://www.404manual.com>

<http://www.luxmanual.com>

<http://aubethermostatmanual.com>

Golf course search by state

<http://golfingnear.com>

Email search by domain

<http://emailbydomain.com>

Auto manuals search

<http://auto.somanuals.com>

TV manuals search

<http://tv.somanuals.com>