

Operating instructions for your

# **Cobra**<sup>®</sup> **75 WX ST**

COMPACT REMOTE MOUNT  
CB RADIO WITH

**SOUNDTRACKER**<sup>™</sup>  
SYSTEM

"Cuts Noise Coming In... Strengthens Signals Going Out"



COBRA ELECTRONICS CORPORATION  
6500 W. Cortland Street  
Chicago, Illinois 60707



"Ingenious Products for  
Easier Communication."



# INTRODUCTION

3

How to use your

## **Cobra® 75 WX ST**

### **CITIZENS BAND RADIO WITH SOUNDTRACKER**

#### **CONTENTS:**

<b>Introduction</b> .....	3	<b>Operation (continued)</b>	
<b>Features</b> .....	3	Receive / Transmit .....	21
<b>Technical Support and service</b> .....	3	One Touch Channel 9 & 19 .....	22/23
<b>Controls and Indicators</b> .....	4/5	Key Lock .....	24
<b>Included with your 75WX</b> .....	6	Frequency Display .....	25
<b>Installation</b> .....	7	All Channel Scan .....	26
Connector Box Location .....	7	Weather Channel .....	27
Mounting Connector Box .....	8/9	Channel Saver .....	28
Microphone Hanger .....	10	Memory Channels .....	28/29
Antenna .....	11	Dual Watch .....	30/31
Speakers .....	12	<b>If you think you need service</b> .....	32
Noise Interference .....	12	<b>How your CB can serve you</b> .....	33
SoundTracker System .....	13	A few rules you should know .....	33
<b>Operation</b> .....	13	Weather Channel Messages .....	34
Turning your CB On .....	14	Channel 9 Emergency Messages .....	35
Selecting a Channel .....	15	CB 10 Codes .....	36
Activating SoundTracker .....	16	<b>Frequency Ranges</b> .....	37
Testing SoundTracker .....	17	<b>Specifications</b> .....	38
Setting the Squelch .....	18/19	<b>Warranty Information</b> .....	39
LCD Readout .....	20	<b>Optional Accessories</b> .....	40

#### **INTRODUCTION**

The Cobra 75 WX ST is the ultimate in remote mount CB transceivers and features the SoundTracker system which dramatically eliminates annoying static to deliver crisp, clear sound quality. The 75's compact, state-of-the-art design provides consistent, outstanding performance in almost all conditions or situations. For ultimate satisfaction and performance from your Cobra 75 WX ST, please review these operating instructions fully, prior to use.

#### **FEATURES**

- SoundTracker System
- 40 CB Radio Channels
- 10 Weather Channels
- One-touch Emergency Channel 9
- One-touch Information Channel 19
- Remote Mount Installation System
- Full Featured LCD Display Panel
- Squelch Control
- Key Lock
- Channel Saver Circuitry
- Dual Watch Channel Monitor
- Full Channel Scan
- Four Memory Locations
- 10-Foot Flexible Cord
- Quick Disconnect

#### **TECHNICAL SUPPORT**

For technical assistance, please call our Automated Help Desk which can assist you by answering the most frequently asked questions about Cobra products.

**(773) 889-3087**

24 hours a day, 7 days a week.

A Consumer Service Representative can be reached through this same number 8:00 am - 8:00 pm, Monday through Friday, CST. Technical assistance is also available on-line in the Frequently Asked Question (FAQ) section at [www.cobraelec.com](http://www.cobraelec.com) or by e-mail to [productinfo@cobraelec.com](mailto:productinfo@cobraelec.com)

# INTRODUCTION

## CONTROLS AND INDICATORS

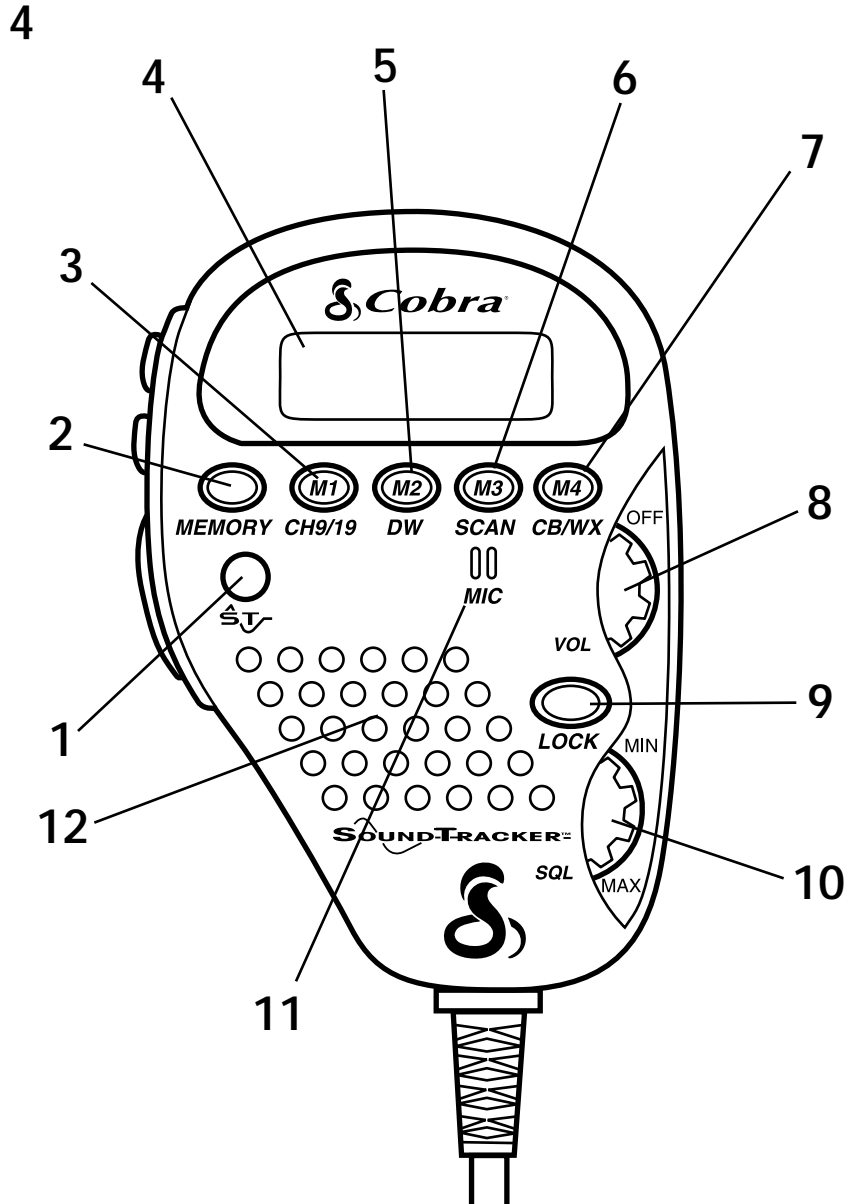

# INTRODUCTION

## CONTROLS AND INDICATORS

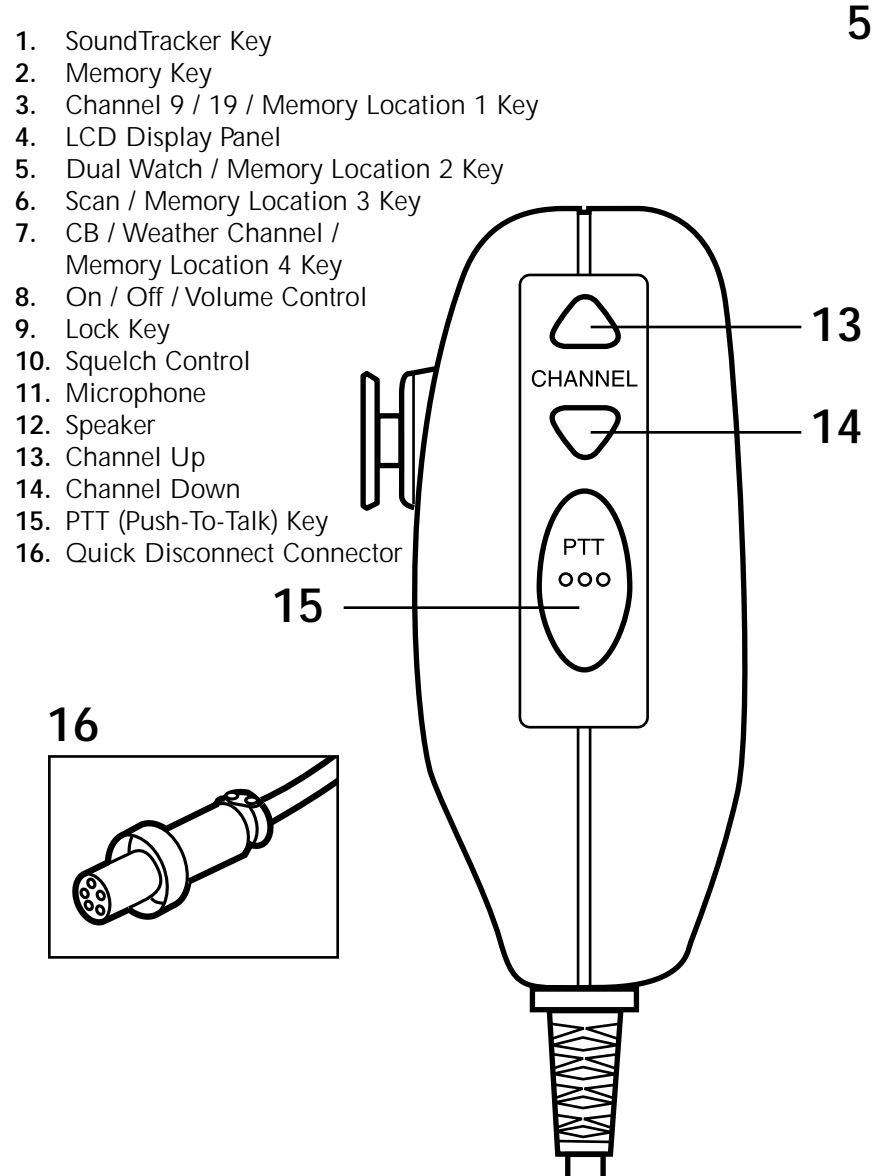

# INTRODUCTION

## COMPONENTS INCLUDED

6

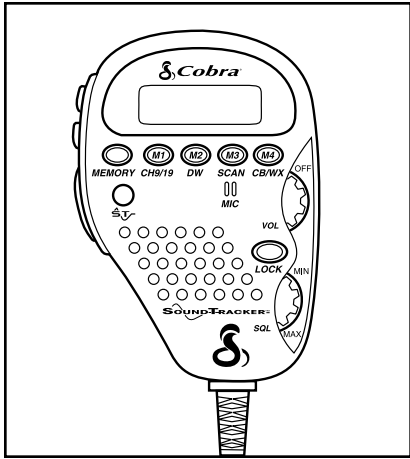

75 WX ST Transceiver

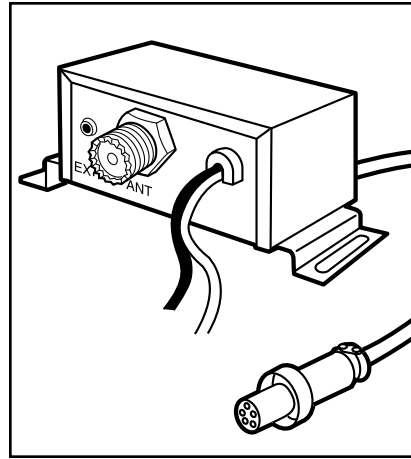

Connector Box

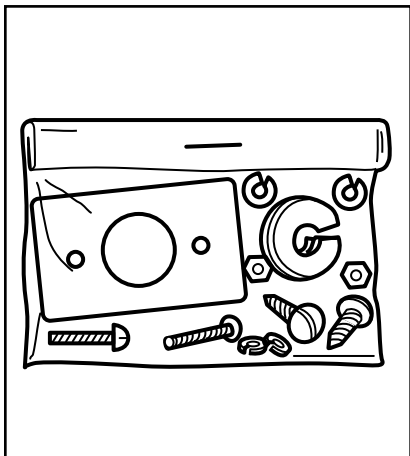

Installation Hardware

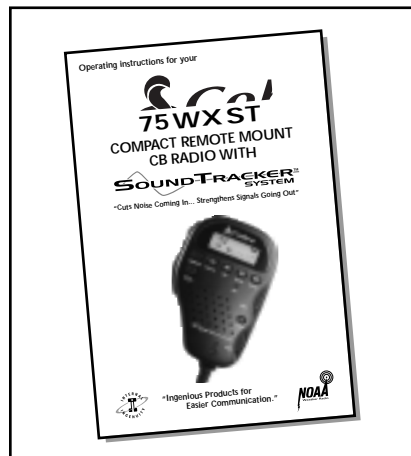

Operating Manual

# INSTALLATION

## CONNECTOR BOX LOCATION

7

### LOCATION

Mount your Cobra 75 WX ST Connector Box in a convenient location, away from moisture and direct sunlight, in a location that will not interfere with driving.

Cobra suggests mounting it either under the front seat or on the fire wall.

### UNDER THE FRONT SEAT INSTALLATION

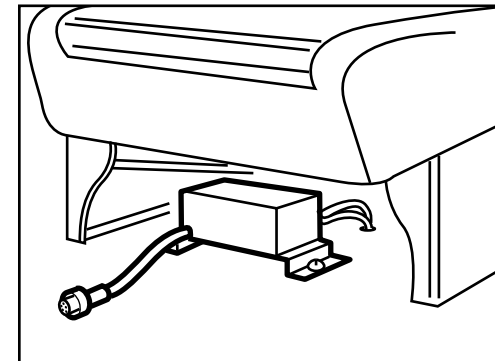

### FIRE WALL INSTALLATION

**NOTE:** Do not mount under the hood, near heat ducts or in direct line of the car's heater.

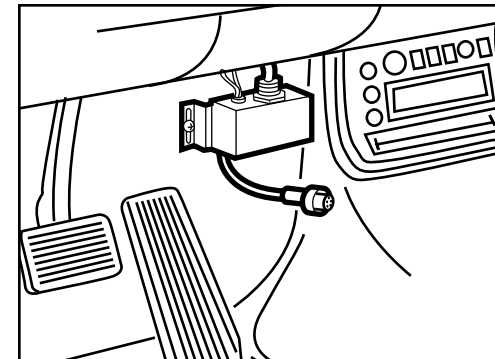

# INSTALLATION

## CONNECTOR BOX

8

### MOUNTING CONNECTOR BOX

1. Hold Cobra 75 WX ST Connector Box in exact location desired for mounting.
2. Using it as a template, mark the location for the mounting screws (included).

**NOTE:** Make certain that nothing will interfere with the installation of the mounting screws, before drilling holes.

3. Mount Connector Box as shown.

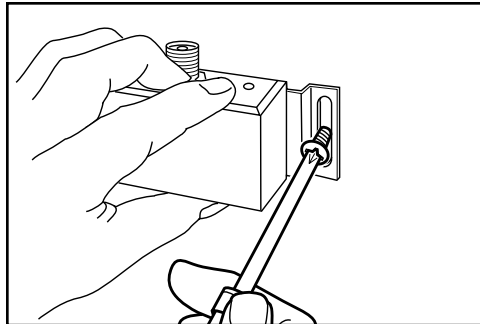
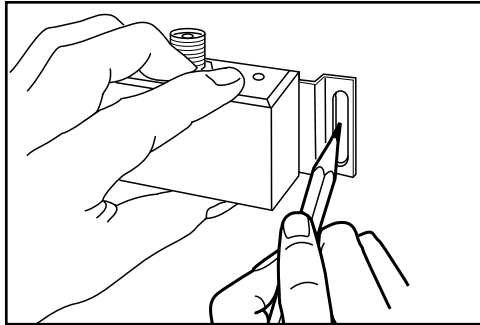

# INSTALLATION

## CONNECTOR BOX

9

### CONNECTING WIRES

1. Connect the antenna cable connector.
2. Connect the red wire marked "BATT" (+) directly to the positive side of the battery or to a connection on the fuse box that is always on.
3. Connect the black wire marked "Ground" (-) to the negative side of the car, usually the chassis. Any other location with good electrical contact (paint removed) will also work.

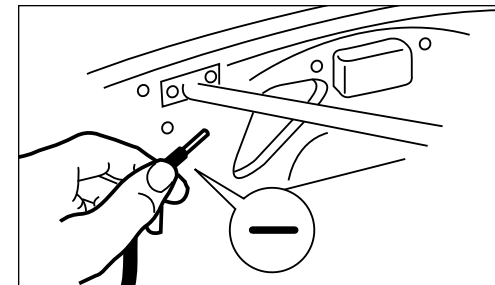
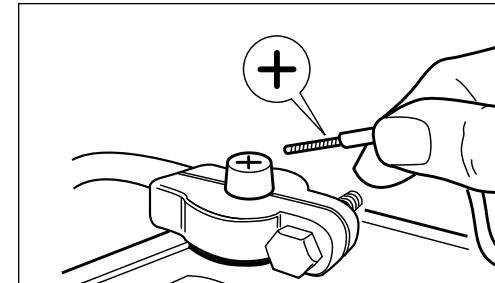
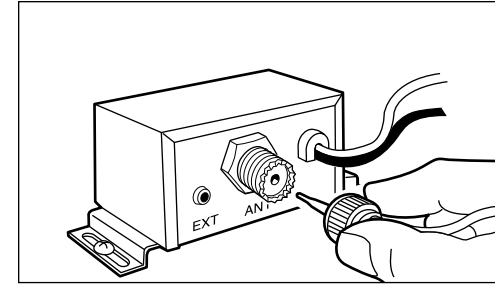

**CAUTION:** Leaving the 75 WX ST on after your car is turned off can drain your car battery when connected to a constant 12 volt source. When connected to accessory 12 volt source unit will turn off.

# INSTALLATION

## MICROPHONE HANGER

10

### INSTALLING MICROPHONE HANGER

1. Hold microphone hanger in location desired for mounting. Make certain that nothing will interfere with the hanger's installation.
2. Mark the location for the three mounting screws (screws included).
3. Drill and mount microphone hanger.

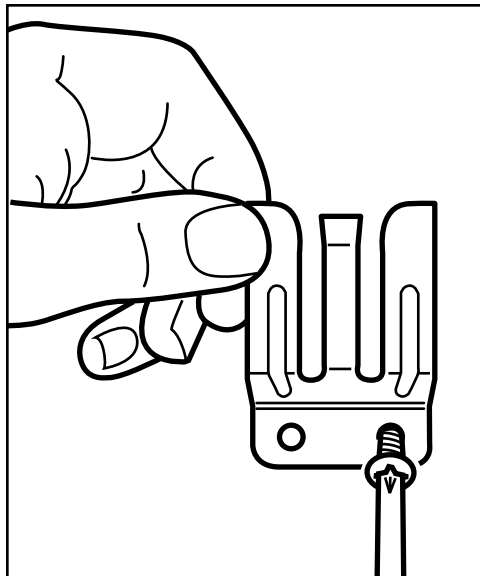
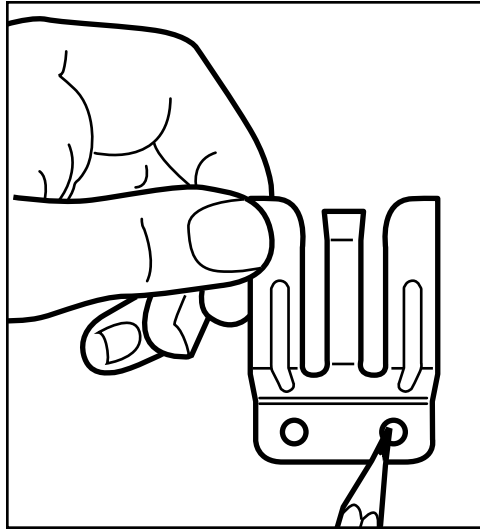

# INSTALLATION

## CB ANTENNA

11

### CB ANTENNA INSTALLATION

For the most reliable operation and maximum range, Cobra recommends using a vertically polarized, quarter wave length whip antenna (illustration A).

Shorter, loaded-type whips are adequate when maximum range is not required (illustration B).

**NOTE:** Mobile installations (cars, trucks, boats, etc) should be made only with a non-directional antenna system.

- A standard antenna connector (Type SO-239) is provided on the Connector Box for easy connection to a standard PL-259 cable termination.
- Cobra antenna models are recommended; see your local CB dealer or order directly from Cobra. See order form on page 40.
- For maximum efficiency in boat installations, a ground plate is required, unless the vessel has a steel hull. Consult your CB dealer for information regarding an adequate grounding system.

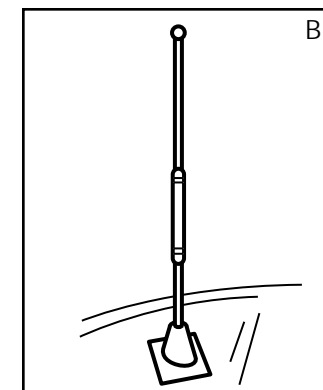
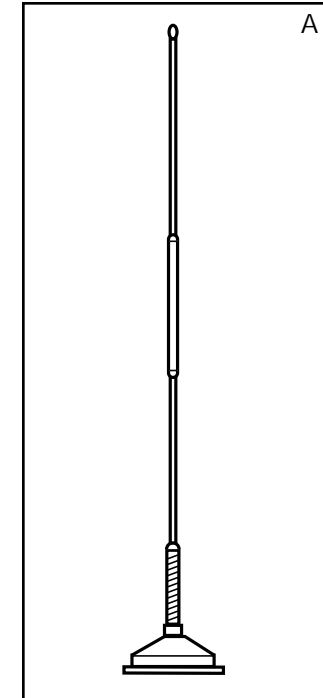

#### EXTERNAL SPEAKER INSTALLATION

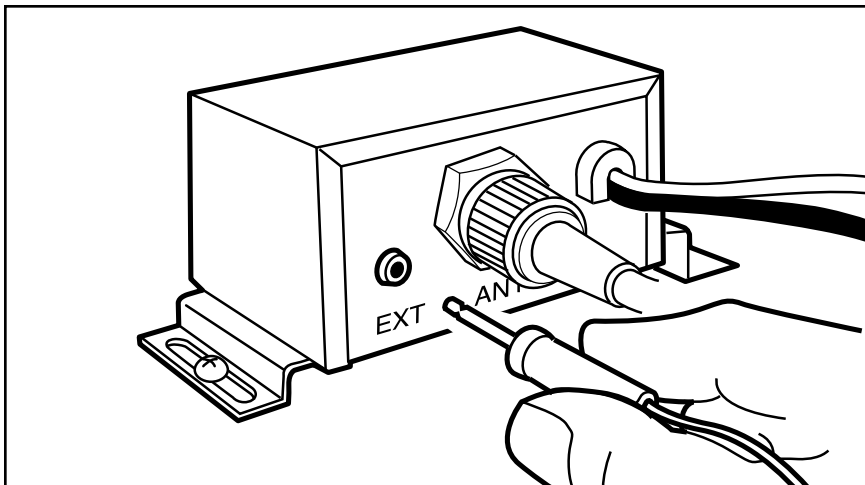

1. Mount external speaker in desired location.
2. Plug jack into the back of the Connector Box labeled EXT.

\*The external speaker should have 4-8 ohms impedance and be able to handle at least 4 watts.

#### IGNITION NOISE INTERFERENCE

The alternator and ignition system in your vehicle may limit your ability to receive low signal levels. Other noise interference can be the result of several different installation variables. Consult your Cobra dealer or a 2-way radio technician to help locate and correct the source of severe noise interference.

#### SOUNDTRACKER SYSTEM

While previous systems only “blacked out” or limited noise in higher sound frequencies, the revolutionary new SoundTracker System actually reduces noise while leaving the signal intact in the reception mode. In the transmission mode, it actually strengthens the signal, providing you with a significant reduction in noise on reception and transmission.

Sound clarity is measured by the ratio of the signal level to the noise level. The higher the signal-to-noise ratio, the better the sound.

#### HOW SOUNDTRACKER WORKS

##### **On Reception** – *“Cuts Noise Coming In”*

With a normal CB, distant signals fall below the squelch level and are unintelligible. With a SoundTracker CB, the noise level is cut by up to 90%, which increases the signal-to-noise ratio and dramatically improves signal clarity. This also allows you to significantly reduce the squelch level, which greatly expands your listening range.

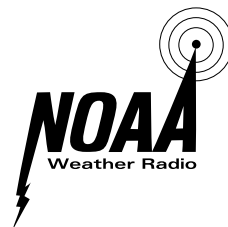

##### **On Transmission** – *“Strengthens Signals Going Out”*

A SoundTracker CB strengthens the transmit signal by more effectively using the available RF power output of the CB. The result is improved transmission signal clarity and an expanded transmission range.

# OPERATION

## TURNING CB ON

14

### TURNING YOUR CB ON

1. Rotate the power ON-OFF Volume Control clockwise.
2. Turn the Squelch Control counterclockwise until noise is heard.
3. Adjust volume to a comfortable level.

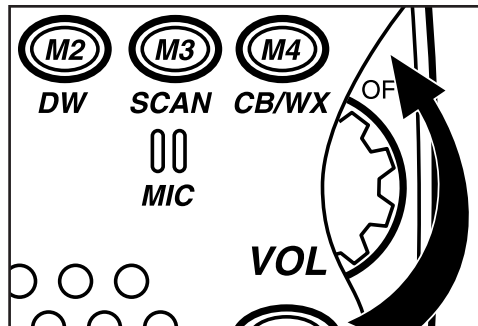
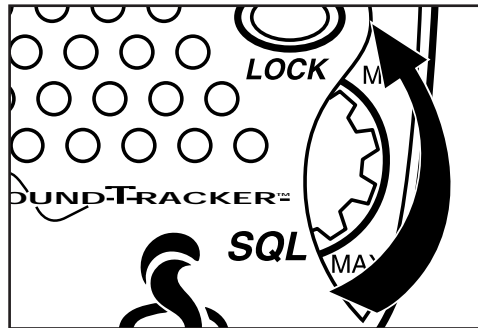
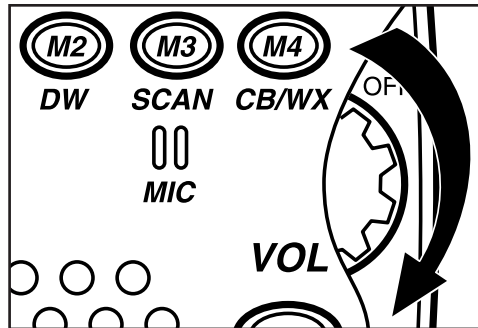

# OPERATION

## SELECTING A CHANNEL

15

### SELECTING A CHANNEL

1. Change channels by pressing either the channel ▲ up or channel ▼ down key .
2. To quick-advance channels, press and hold either key.

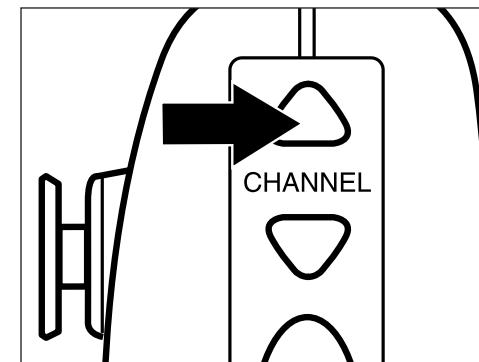
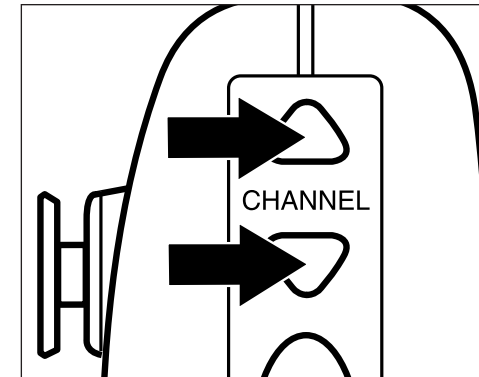



# OPERATION

## ACTIVATING SOUNDTRACKER

16

### ACTIVATING SOUNDTRACKER

1. Depress the Sound-Tracker key.

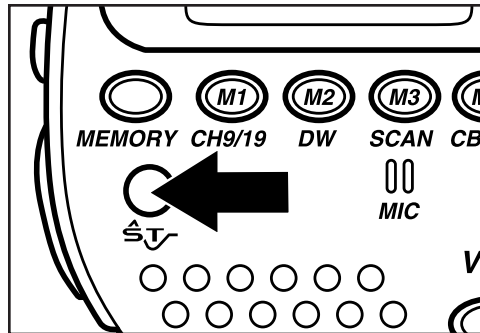

2. **ST** will be displayed on the LCD readout.

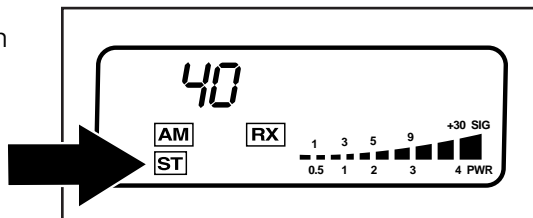

# OPERATION

## TESTING SOUNDTRACKER

17

### TESTING SOUNDTRACKER

1. Select any unused channel on your CB.
2. Open the squelch control fully by turning the knob counterclockwise until it stops.
3. Turn the volume up louder than your normal listening level.
4. Depress the SoundTracker key. Notice the significant reduction in noise.

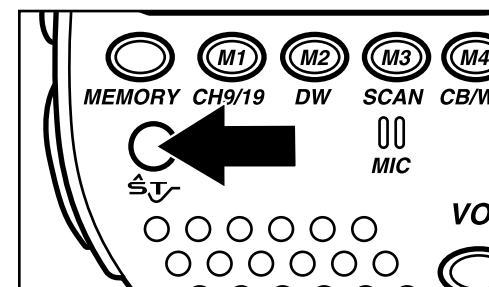
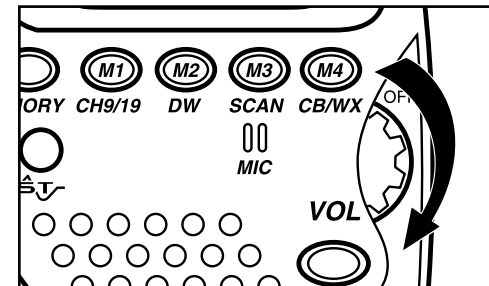
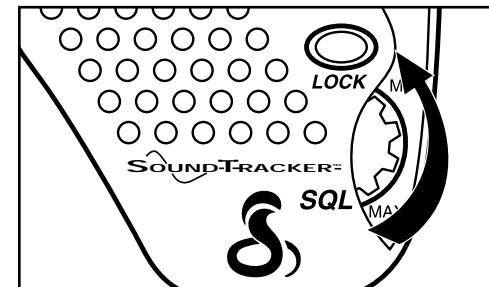
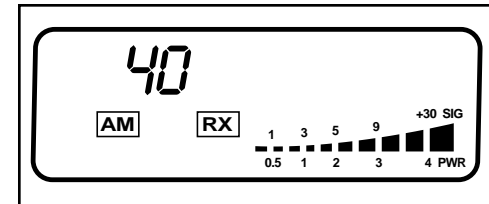

# OPERATION

## SETTING THE SQUELCH

18

### SETTING THE SQUELCH

1. Turn CB on by turning the volume control clockwise. Adjust the volume to a comfortable level.

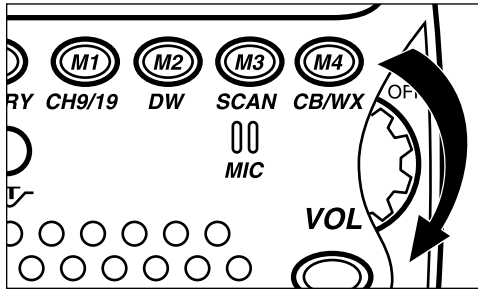

2. Before setting the squelch control on your radio, you must select a channel that is not in use.

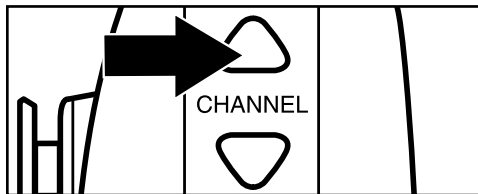

3. Turn on SoundTracker.

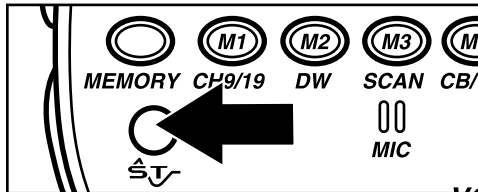

To achieve the **Desired Squelch Setting (DSS)**:

4. Think of your Squelch Control as a gate for incoming signals. If you turn the Squelch Control fully clockwise, it raises the "squelch gate" so high that no signals get through.

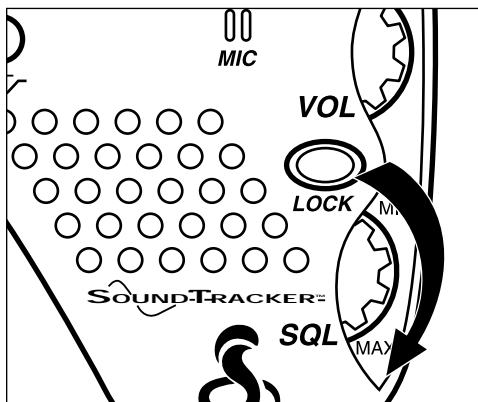
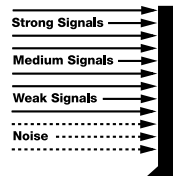

5. If you turn the squelch control fully counter-clockwise, it lowers the "squelch gate" so low that everything gets through - noise, weak signals and strong signals.

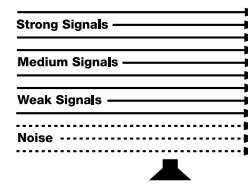

6. To set the "squelch gate" to the DSS-Desired Squelch Setting, turn the squelch control counterclockwise until you hear noise. Then turn the squelch control back clockwise just until the noise stops. Now only strong signals get through.

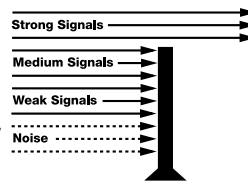

The Desired Squelch Setting, **(DSS)** only allows actual transmissions to come through. This effectively blocks out unwanted noise.

# OPERATION

## SETTING THE SQUELCH

19

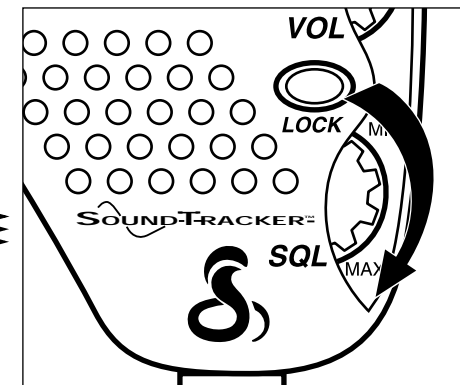
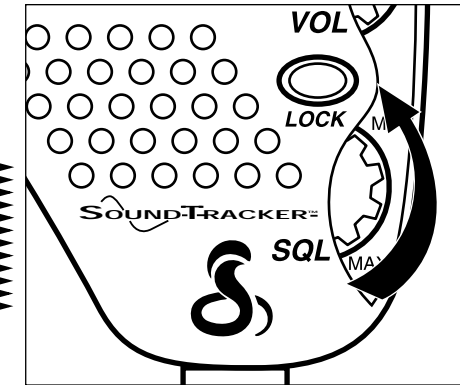

# OPERATION

## LCD READOUT

20

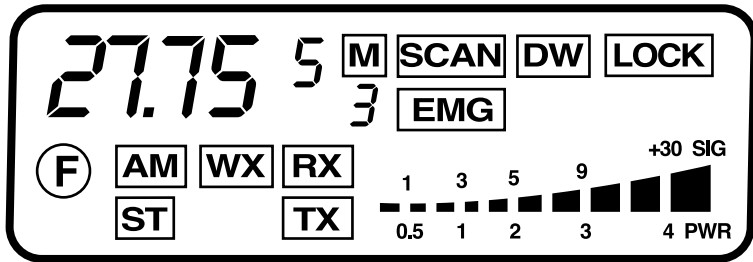

### LCD DISPLAY

Your Cobra 75 WX ST CB is designed with a liquid crystal display that indicates channel number, frequency and the operating mode.

2 digit channel display / 5 digit frequency display

**M** = Memory Indicator

**SCAN** = Scan Indicator

**DW** = Dual Watch Indicator

**LOCK** = Lock Key Indicator

Memory Channel Number

**EMG** = Emergency Channel 9

**F** = Function key indicator

**AM** = Amplitude Modulation

**WX** = Weather Station

**RX** = Receive Indicator

**ST** = SoundTracker indicator

**TX** = Transmit Indicator

Signal Strength Meter

**NOTE:** To avoid damaging the LCD display, do not subject your CB radio to extreme temperatures (below -5°F or above 140°F) for extended periods of time.

# OPERATION

## TRANSMIT/RECEIVE

21

### TO RECEIVE

1. Your 75 WX ST is automatically in the receive mode and **RX** is illuminated.

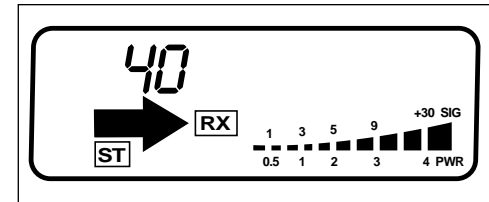

### TO TRANSMIT

1. Press the Press-To-Talk (PTT) key.

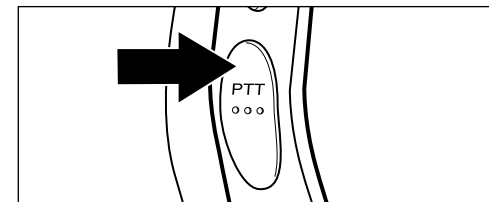

2. The TX icon will appear

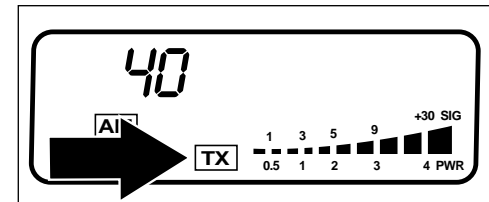

3. Hold the microphone about 2 inches from your mouth and speak in a normal voice.

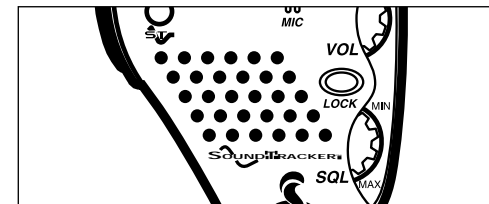

4. Release the PTT button and you will automatically be in the receive mode again.

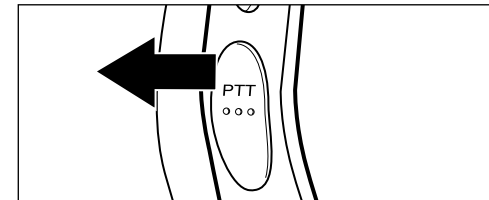

# OPERATION

## ONE TOUCH CHANNEL 9 AND 19

22

### EMERGENCY CHANNEL 9 OR INFORMATION CHANNEL 19

1. To access emergency channel 9, press Channel 9/19 key once.

2. You are now on emergency channel 9 and the **EMG** icon will appear.

3. To access information channel 19, press Channel 9/19 key again.

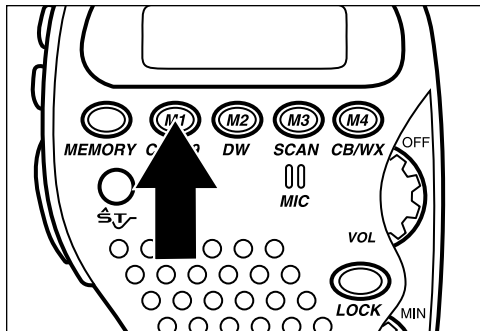
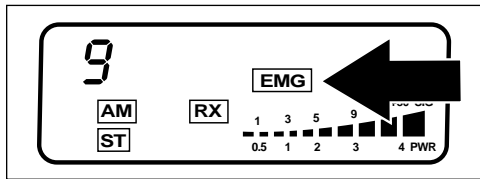
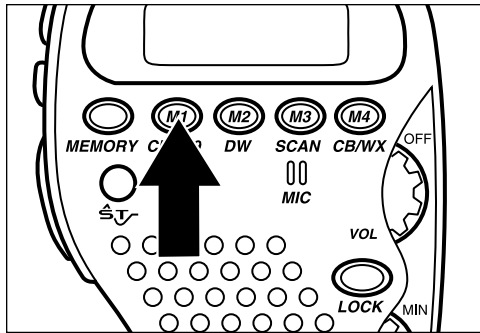

4. You are now on information channel 19

5. Press 9/19 again to return to the original channel selected.

6. Original channel

# OPERATION

## ONE TOUCH CHANNEL 9 AND 19

23

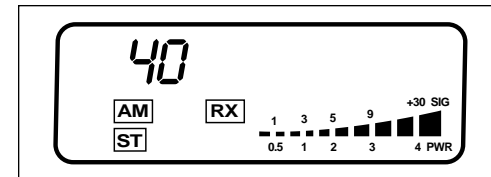
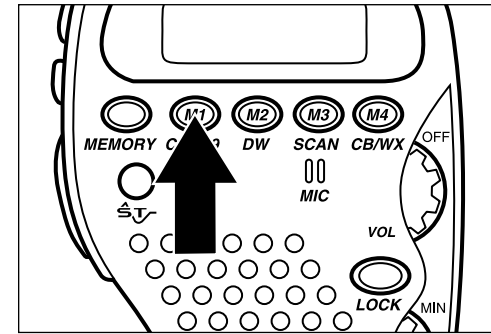
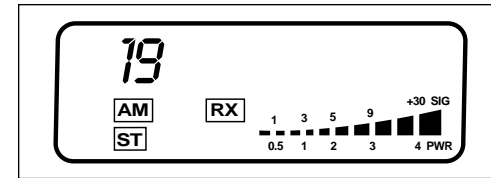

# OPERATION

## KEY LOCK

24

### KEY LOCK

1. Press Key Lock button to prevent unintentional channel changing.

2. You are now locked and the **LOCK** icon will appear.

3. Press Key Lock button again to deactivate.

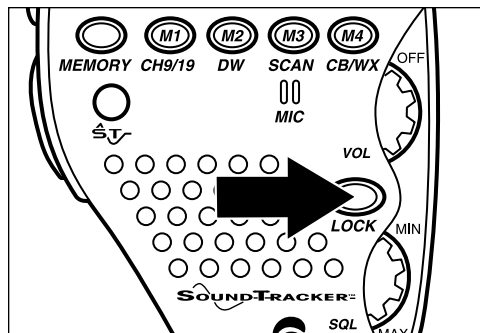
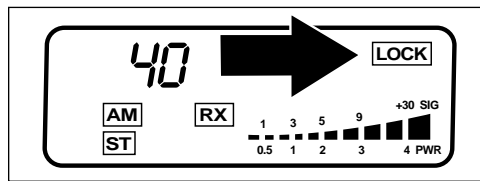
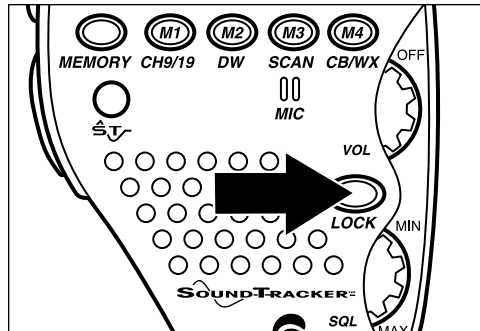

### 5 DIGIT FREQUENCY DISPLAY

1. Push and hold Memory key for approximately 3 seconds.

2. Display will change to the 5 digit frequency of the channel selected.

3. Push and hold Memory key for 3 seconds.

4. Display will change back to channel display.

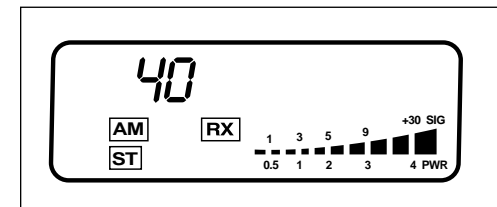
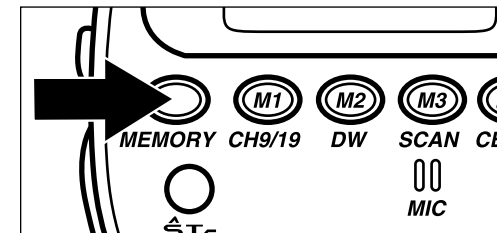
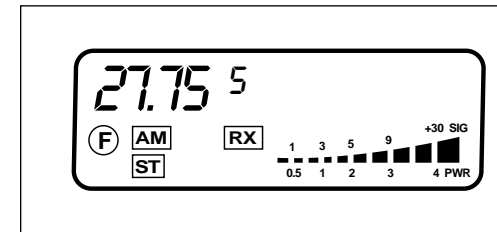
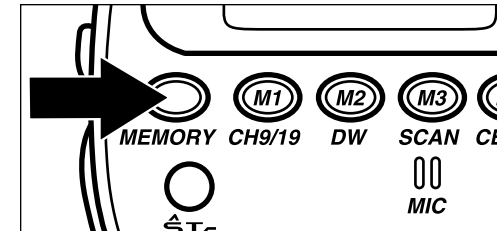

25

# OPERATION

## FREQUENCY DISPLAY

# OPERATION

## CHANNEL SCAN

26

### ALL CHANNEL SCAN

1. Set Squelch Control (SQL) to desired setting DSS.  
\*See page 18 to set DSS.

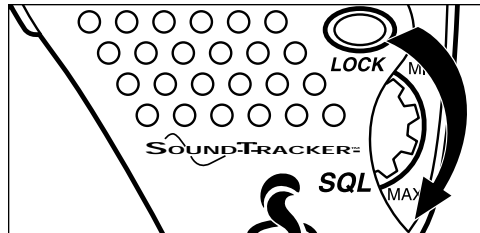

2. Press Scan key. When activity is found on a channel scanning will stop.

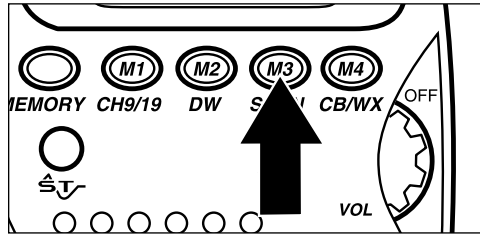

3. Scan icon will appear.

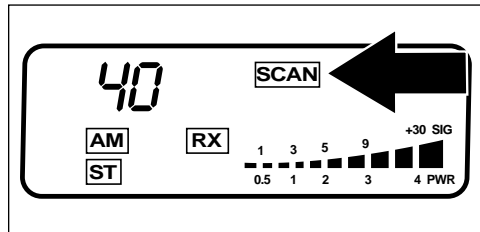

4. Press any key to stop scanning sequence.

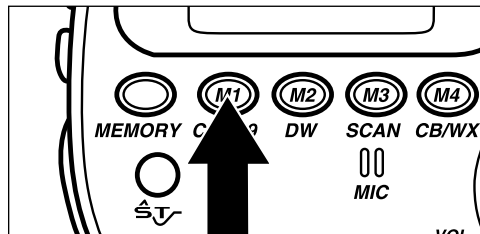

**NOTE.** The 75 WX ST will stop scanning and monitor a channel when it receives an incoming transmission. Five seconds after the transmission stops, the 75 WX ST will resume the scanning function.

# OPERATION

## WEATHER CHANNELS

27

### WEATHER CHANNELS

1. Press the CB/WX key.

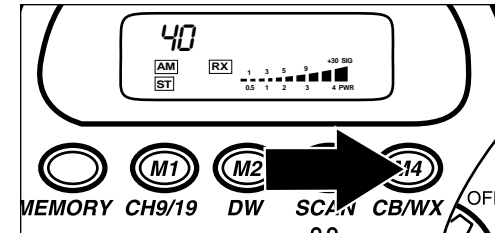

2. The unit will change to the WX function and a weather channel number will be displayed.

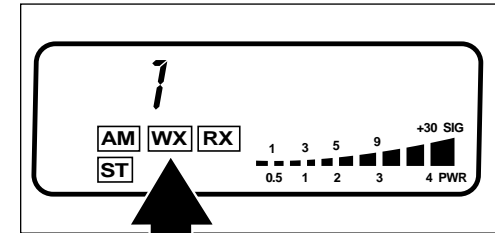

2. Press Up/Down Channel keys to locate the weather station in your area.

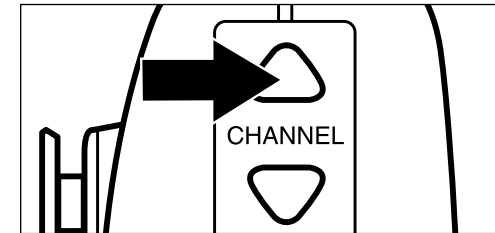

3. Press the CB/WX key to return to a normal CB channel.

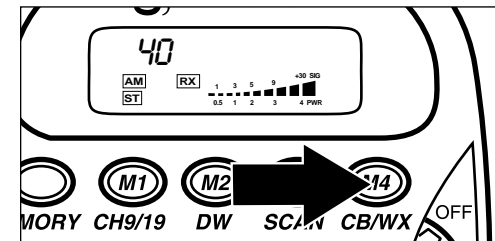

# OPERATION

## CHANNEL SAVER/MEMORY CHANNELS

28

### CHANNEL SAVER FEATURE\*

Automatically retains the last channel used when CB is turned off and returns you to that channel when CB is turned back on.

\*To function, the "red wire" must be directly connected to either:

1. Positive (+) battery terminal.
2. Connection on the fuse box that is always on.  
See installation section for details.

**NOTE:** Leaving the 75 WX ST on after your car is turned off can drain your car battery when connected to a constant 12 volt source.

### SAVING CHANNELS IN MEMORY

1. Select desired channel to store in memory.
2. PRESS and RELEASE the Memory key.
3. PRESS and HOLD the desired Memory Location key to lock channel into memory.
4. The Memory Location will appear on the display.

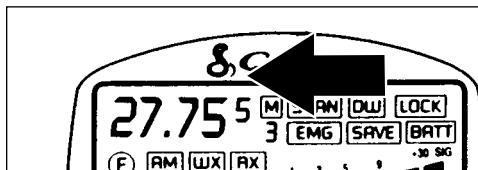
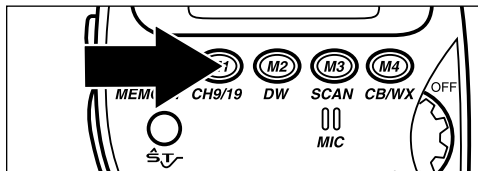
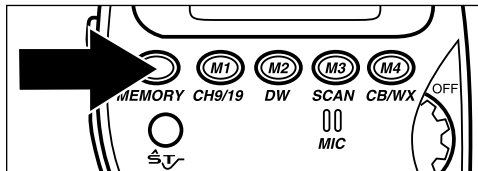
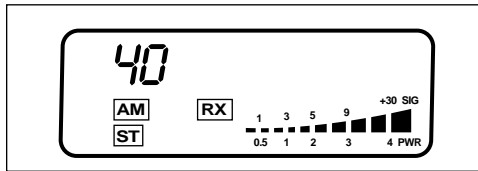

# OPERATION

## MEMORY CHANNELS

29

### RETRIEVING CHANNELS FROM MEMORY

1. PRESS and RELEASE the Memory key.
2. PRESS and RELEASE the desired Memory Location key.
3. The channel in the memory location will be recalled.
4. Repeat to recall other Memory Locations.

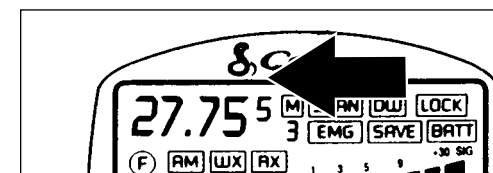
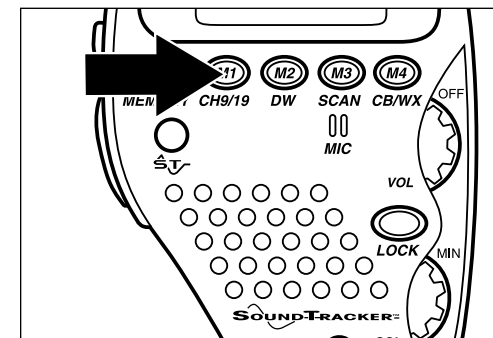
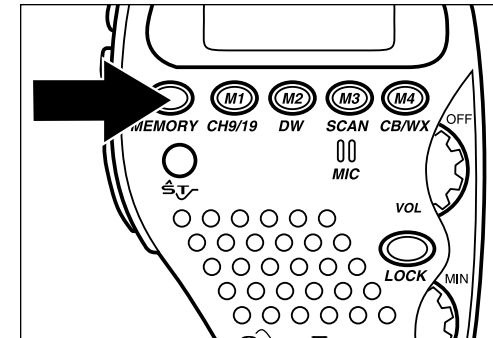

# OPERATION

## DUAL WATCH

30

### DUAL WATCH

Allows you to simultaneously monitor any two preselected channels at one time.

1. Adjust squelch (SQL) setting to the DSS level (see page 18).

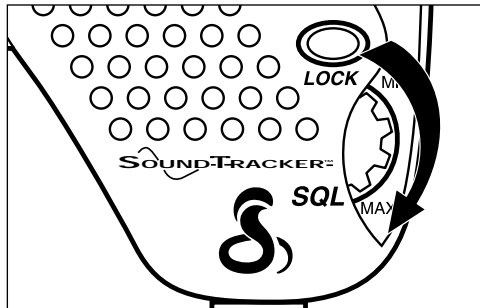

2. Set CB to one of the stations you wish to monitor.

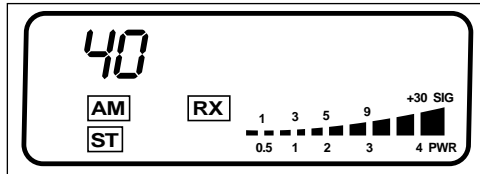

3. PRESS and Hold the DW key until a beep is heard.

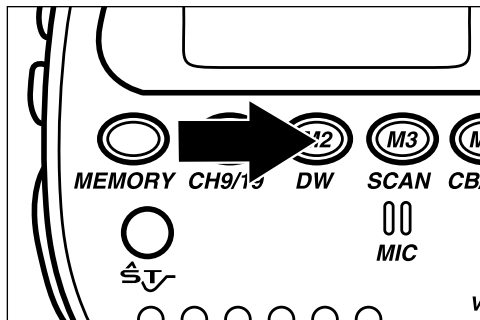

4. Select new channel.

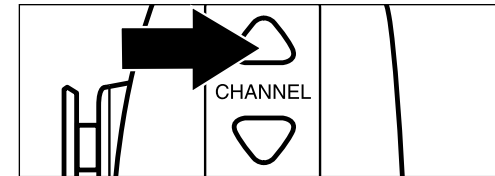

5. Press and hold DW key until a beep is heard.

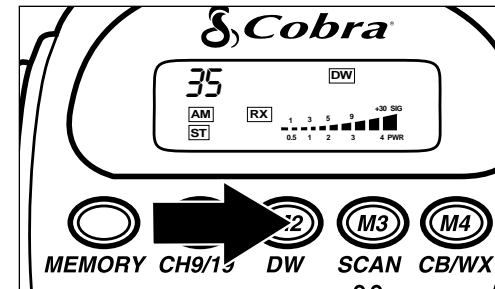

6. The **DW** icon appears and monitoring begins.

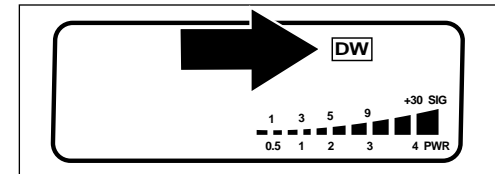

7. Press any key to stop monitoring function.

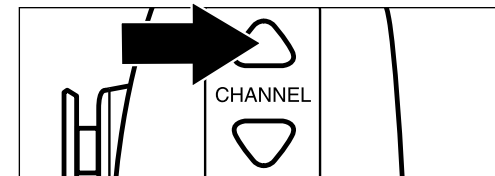

**NOTE:** The 75 WX ST will alternate between both channels until it receives an incoming transmission. Five seconds after the transmission stops, it will again alternate between both channels.

31

# OPERATION

## DUAL WATCH



## 32 If You Think You Need Service, Call 773-889-3087

**“If your product should require factory service please call Cobra first before sending your unit in. This will ensure the fastest turnaround time on your repair.”**

You may be asked to send your unit to the Cobra factory. It will be necessary to furnish the following, in order to have the product serviced and returned.

1. For Warranty Repair proof-of-purchase, such as a mechanical reproduction or carbon or a sales receipt will be required. If you send the original receipt it cannot be returned.
2. The entire product, including CB unit and microphone must be sent in.
3. Enclose a description of what is happening with the unit. Include a typed or clearly printed name and address of where the unit is to be returned.
4. Pack unit securely to prevent damage in transit. If possible, use the original packing material.
5. Ship **prepaid and insured by way of a traceable carrier** (to avoid loss in transit) such as **United Parcel Service (UPS), Roadway Parcel Service (RPS) or First Class Insured Mail to Cobra Factory Service, Cobra Electronics Corporation, 6500 W. Cortland St., Chicago, IL 60707. Cobra is not responsible for units not received if package has not been properly insured.**
6. If the unit is in warranty, upon receipt of your unit it will either be repaired or exchanged depending on the model. Please allow approximately 3 to 4 weeks before contacting us for status. If the unit is out of warranty a letter will automatically be sent informing you of the repair charge or replacement charge. If you have any questions, please call 773-889-3087 for assistance.

**For technical assistance, please call our Automated Help Desk  
which can assist you by answering the most  
frequently asked questions about Cobra products.  
(773) 889-3087**

**24 hours a day, 7 days a week.**

**A Consumer Service Representative can be reached through this same  
number 8:00 am - 8:00 pm, Monday through Friday, CST.**

**Technical assistance is also available on-line in the  
Frequently Asked Question (FAQ) section at [www.cobraelec.com](http://www.cobraelec.com) or by e-mail  
to [productinfo@cobraelec.com](mailto:productinfo@cobraelec.com)**

## 33

### HOW YOUR CB CAN SERVE YOU

- Warn of traffic tie-ups ahead.
- Provide weather and road information.
- Provide help fast in event of emergency or breakdown.
- Suggest good spots to eat and sleep.
- Make long trips more interesting, and help keep you awake.
- Provide direct contact with your office or home.
- Make friends as you travel.
- Provide “local information” to find your destination.
- Communicate with friends and family during outdoor activities.
- Help law enforcement officers by reporting drunk and reckless drivers.

### A FEW RULES YOU SHOULD KNOW

1. You are not allowed to carry on a conversation with another station for more than five minutes at a time without taking a one-minute break to give others a chance to use the channel.
2. You are not allowed to blast others off the air by overpowering them with illegally amplified transmitter power or illegally high antennas.
3. You can't use the CB to promote illegal activities.
4. You are not allowed to use profanity.
5. You may not play music in your CB.
6. You may not use your CB to sell merchandise or professional service.

## WEATHER CHANNEL MESSAGES

You can receive up to the minute local area weather reports provided by NOAA (National Oceanic Atmospheric Administration) 24 hours a day, 7 days a week. An agency of the U.S. Department of Commerce, NOAA warns of dangerous weather, charts our seas and skies, guides our use and protection of ocean and coastal resources and conducts research to improve our understanding and stewardship of the environment.

The National Weather Service operates about 380 stations. Approximately 90 percent of the Nation's population is within listening range of a NOAA Weather Radio broadcast.

A similar network of about 15 stations using the same frequencies broadcast continuous weather information across much of southern Canada.

If you have a question concerning NOAA Weather Radio or wish to receive a listing of NOAA Weather Radio receiver locations, please contact your nearest National Weather Service Office, or write to National Weather Service (Attn: W/OM11), National Oceanic and Atmospheric Administration, Silver Spring, MD. 20910.

**Note:** Some areas may not have a broadcast tower within the receiving range of your 75 WX ST.

## USE CHANNEL 9 FOR EMERGENCY ONLY

### Operating Procedure for Emergency Communications

- For **EMERGENCY** communications, **set radio to Ch. 9**. For non-emergency communications, select desired Channel by pressing the CHANNEL UP/DOWN tuning buttons until reaching the desired Channel.  
**Be sure the antenna is properly connected to the radio before transmitting. Prolonged transmitting without an antenna, or use of a poorly matched antenna, could cause damage to the transmitter.**
- When asking for aid on Channel 9 it is suggested that you request a **REACT** base to respond by saying "Break Channel 9 for a REACT base" and provide the **CB DISTRESS DATA (called "CLIP")**:  
**CALL SIGN**-Identify yourself and vehicle.  
**LOCATION**-Be exact.  
**INJURIES**-Number. Type. Trapped?  
**PROBLEM**- Give details and help required. Air **CLIP** repeatedly so any monitor can aid you.

If you don't receive a response on Ch. 9; try Ch.14 or 19.

FCC gives the following examples of permitted and prohibited types of communications for use on Channel 9. These are guidelines and are not intended to be all-inclusive.

Permitted	Example Message
Yes	"A tornado sighted six miles north of town."
No	"This is observation post number 10. No tornado sighted."
Yes	"I am out of gas on Interstate 95 at mile marker 121."
No	"I am out of gas in my driveway."
Yes	"There is a four-car collision at Exit 10 on the Beltway, send police and ambulance."
No	"Traffic is moving smoothly on the Beltway."
Yes	"Base to Unit 1, the Weather Bureau has just issued a thunderstorm warning. Bring the sailboat into port."
No	"Attention all motorists. The Weather Bureau advises that the snow tomorrow will accumulate 4 to 6 inches."
Yes	"There is a fire in the building on the corner of 6th and Main Streets."
No	"This is Halloween patrol unit number 3. Everything is quiet here."

**CB 10-CODES**

Citizens Band radio operators have largely adopted the "10-code" for standard questions and answers. Its use permits faster communications and better understanding in noisy areas. The following table lists some of the more common codes and their meanings:

Code	Meaning	Code	Meaning
10-1	Receiving poorly	10-37	Wrecker needed at
10-2	Receiving well	10-38	Ambulance needed at
10-3	Stop transmitting	10-39	Your message delivered
10-4	OK, message received	10-41	Please turn to channel
10-5	Relay message	10-42	Traffic accident at
10-6	Busy, stand by	10-43	Traffic Tie up at
10-7	Out of service, leaving air	10-44	I have a message for you
10-8	In service, subject to call	10-45	All units within range please report
10-9	Repeat message	10-50	Break channel
10-10	Transmission completed, standing by	10-60	What is next message number?
10-11	Talking too rapidly	10-62	Unable to copy, use phone
10-12	Visitors present	10-63	Net directed to
10-13	Advise Weather/Road conditions	10-64	Net clear
10-16	Make pick up at	10-65	Awaiting your next message/assignment
10-17	Urgent business	10-67	All units comply
10-18	Anything for us?	10-70	Fire at
10-19	Nothing for you, return to base	10-71	Proceed with transmission in sequence
10-20	My location is	10-77	Negative contact
10-21	Call by telephone	10-81	Reserve hotel room for
10-22	Report in person to	10-82	Reserve room for
10-23	Stand by	10-84	My telephone number is
10-24	Completed last assignment	10-85	My address is
10-25	Can you contact	10-91	Talk closer to mike
10-26	Disregard last information	10-93	Check my frequency on this channel
10-27	I am moving to channel	10-94	Please give me a long count
10-28	Identify your station	10-99	Mission completed, all units secure
10-29	Time is up for contact	10-200	Police needed at
10-30	Does not conform to FCC rules		
10-32	I will give you a radio check		
10-33	EMERGENCY TRAFFIC		
10-34	Trouble at this station		
10-35	Confidential information		
10-36	Correct time is		

**FREQUENCY RANGE**

Your COBRA transceiver represents one of the most advanced AM two-way radios used as a Class D station in the Citizens Radio Service. This unit features advanced Phase Lock Loop (PLL) circuitry providing complete coverage of all 40 CB channels and 10 weather channels as shown below.

CB Channel	Channel Freq. in MHz	CB Channel	Channel Freq. in MHz	Weather Channel	Weather Freq. in MHz
1	26.965	21	27.215	1	162.550
2	26.975	22	27.225	2	162.400
3	26.985	23	27.255	3	162.475
4	27.005	24	27.235	4	162.425
5	27.015	25	27.245	5	162.450
6	27.025	26	27.265	6	162.500
7	27.035	27	27.275	7	162.525
8	27.055	28	27.285	8	161.650
9	27.065	29	27.295	9	161.775
10	27.075	30	27.305	0	163.275
11	27.085	31	27.315		
12	27.105	32	27.325		
13	27.115	33	27.335		
14	27.125	34	27.345		
15	27.135	35	27.355		
16	27.155	36	27.365		
17	27.165	37	27.375		
18	27.175	38	27.385		
19	27.185	39	27.395		
20	27.205	40	27.405		

This device complies with part 15 of the FCC rules. Operation is subject to the following conditions:

1. This device may not cause harmful interference
2. This device must accept any interference received, including interference that may cause undesired operation.

## 75WXST SPECIFICATIONS

## GENERAL

CHANNELS	CB - 40 CH WEATHER - 10 CH
FREQUENCY RANGE	CB - 26.965 TO 27.405 MHZ WEATHER - 161.650 TO 163.275 MHZ
FREQUENCY TOLERANCE	0.005 %
FREQUENCY CONTROL	PLL (PHASE LOCK LOOP) SYNTHESIZER
OPERATING TEMPERATURE RANGE	-30° C TO + 65° C
MICROPHONE	ELECTRET, PUSH-TO-TALK
INPUT VOLTAGE	13.8 VDC, EXTERNAL
ANTENNA CONNECTOR	SO 239
METER	LCD DISPLAY, ICONS
SIZE	L 2 3/4" x W 1 7/8" x H 4 1/4"
WEIGHT	1 LB.

## TRANSMITTER

POWER OUTPUT	4.0 W AT 13.8 VDC
MODULATION	AM
FREQUENCY RESPONSE	300 - 3000 HZ AT -6 DB
OUTPUT IMPEDANCE	50 OHMS, UNBALANCED

## RECEIVER

CB	
SENSITIVITY IF FREQUENCY	LESS THAN 1 $\mu$ V FOR 10 DB S/N DUAL CONVERSION 1 ST - 10.690 MHZ, 2ND - 455 KHZ
AUDIO OUTPUT	500 mW MAXIMUM AT 10 % THD
FREQUENCY RESPONSE	300 - 3000 HZ AT -6 DB
2ND IF IMAGE REJECTION	GREATER THAN 60 DB
ADJACENT CH. REJECTION	50 DB MIN.
AUTOMATIC NOISE LIMITER	BUILT- IN.
FREQUENCY CONTROL	PLL (PHASE LOCK LOOP)

## WEATHER

SENSITIVITY IF FREQUENCY	LESS THAN 1 $\mu$ V FOR 12 DB SINAD DUAL CONVERSION 1st: -10.690 MHz 2nd: -455 KHz
AUDIO OUTPUT	MAXIMUM 500 mW AT 10 % THD
FREQUENCY RESPONSE	300 - 3000 HZ AT -6 DB

## LIMITED TWO YEAR WARRANTY

**COBRA ELECTRONICS CORPORATION** warrants that its COBRA CB Radios, and the component parts thereof, will be free of defects in workmanship and materials for a period of two (2) years from the date of first consumer purchase. This warranty may be enforced by the first consumer purchaser, provided that the product is utilized within the U.S.A.

COBRA will, without charge, repair or replace, at its option, defective CB radios, products or component parts upon delivery to the COBRA factory Service Department, accompanied by proof of the date of first consumer purchase, such as a duplicated copy of a sales receipt.

You must pay any initial shipping charges required to ship the product for warranty service, but the return charges will be at Cobra's expense, if the product is repaired or replaced under warranty. For further details concerning procedures for obtaining service, see the "If You Think You Need Service" section of the Owner's Manual.

**Exclusions:** This limited warranty does not apply; 1) to any product damaged by accident; 2) in the event of misuse or abuse of the product or as a result of unauthorized alterations or repairs; 3) if the serial number has been altered, defaced or removed; 4) if the owner of the product resides outside the U.S.A.

**All implied warranties, including warranties of merchantability and fitness for a particular purpose are limited in duration to the length of this warranty.**

**COBRA shall not be liable for any incidental, consequential or other damages; including, without limitation, damages resulting from loss of use or cost of installation.**

**Some states do not allow limitations on how long an implied warranty lasts and/or do not allow the exclusion or limitation of incidental or consequential damages, so the above limitations may not apply to you.**

**COBRA ELECTRONICS CORPORATION**  
6500 W. Cortland Street  
Chicago, Illinois 60707

# 40

## OPTIONAL ACCESSORIES

You can find these fine accessories at your local Cobra CB dealer.



High Performance  
Magnetic Mount  
Weather/CB Antenna.  
ATW-400 \$39.95



Remote connector box.  
AC-701 \$29.95



4 foot extension cord.  
AC-702 \$19.95

### If you wish, you can order directly from Cobra

**Order by phone:**

Call 1-773-889-3087 (Press 1 from the main menu) 8a.m.-8p.m. M-F CST.

**Order by mail or fax:** Please fill out order form below, and mail/fax directly to Cobra.

Part No.	Cost Ea.	X Qty.	= Amount
AC-701	\$29.95		
AC-702	\$19.95		
ATW-400	\$39.95		

(Prices subject to change without notice)

- \*\* Illinois residents add 7%
- \*\* Cook Co. residents add .75% (7.75% total)
- \*\* Chicago residents add 1% (8.75% total)
- \*\* Indiana residents add 5%
- \*\* Michigan residents add 4 %
- \*\* Minnesota residents add 6%
- \*\* Ohio residents add 6%
- \*\* Wisconsin residents add 5%

**Fax to:** Amount \_\_\_\_\_  
1-773-622-2269 (Tax if applicable) \_\_\_\_\_  
Shipping/handling **\$3.75** \_\_\_\_\_  
Total \_\_\_\_\_

**Mail to:**  
Cobra Accessories Dept.  
6500 W. Cortland St.,  
Chicago, IL 60707

Please print clearly:

Name _____
Address (Not P.O. Box) _____
City _____ State _____ Zip _____
Credit Card No. _____ Exp. Date _____
Customer Signature _____
Circle One: <input type="checkbox"/> Visa <input type="checkbox"/> MasterCard <input type="checkbox"/> Discover

Allow 4 to 6 weeks for delivery. Offer valid in Continental U.S. only.

## Free Manuals Download Website

<http://myh66.com>

<http://usermanuals.us>

<http://www.somanuals.com>

<http://www.4manuals.cc>

<http://www.manual-lib.com>

<http://www.404manual.com>

<http://www.luxmanual.com>

<http://aubethermostatmanual.com>

Golf course search by state

<http://golfingnear.com>

Email search by domain

<http://emailbydomain.com>

Auto manuals search

<http://auto.somanuals.com>

TV manuals search

<http://tv.somanuals.com>