

OPERATING INSTRUCTIONS FOR YOUR

**Cobra**<sup>®</sup>  
40 CHANNEL

**SOUNDTRACKER**<sup>®</sup>  
SYSTEM

**CITIZENS BAND  
SSB/AM 2-WAY  
MOBILE RADIO**

Model 148 GTL ST

**Cobra**<sup>®</sup>  
Cobra Electronics Corporation  
6500 W. Cortland Street  
Chicago, IL 60707





## 40-CHANNEL, CITIZENS BAND SSB/AM 2-WAY MOBILE RADIO Model 148 GTL ST

Contents	Page
The CB/SoundTracker Story .....	1
<b>Section I: Introduction</b> .....	2
<b>Section II: Specifications</b> .....	3, 4
<b>Section III: Installation</b> .....	5, 6, 7, 8
<b>Section IV: Operation</b> .....	9 - 17
Controls and Indicators .....	9
A. Control Functions.....	9, 10, 11
B. Indicator Functions .....	12
Operating Procedure to Receive.....	12
Operating Procedure to Transmit .....	13
Receiving SSB Signals .....	13, 14
Alternate Microphones and Installation .....	15, 16, 17
<b>Section V: Maintenance and Adjustment</b> .....	18 - 21
FCC Warning .....	18
How SoundTracker Works .....	19
Activating/Testing SoundTracker .....	20
<b>Section VI: Appendix</b> .....	21, 22, 23
Ten Code .....	21
A few Rules That Should Be Obeyed .....	22
How Your CB Can Serve You .....	22
Use Channel 9 for Emergency Messages Only .....	23
Warranty Service Instructions.....	24
Limited Two Year Warranty.....	25
<b>Cobra CB Radio Accessories</b> .....	26

### The CB Story

The Citizens Band lies between the shortwave broadcast and 10-meter Amateur radio bands, and was established by law in 1949. The Class D two-way communications service was opened in 1959. (CB also includes a Class A citizens band and Class C remote control frequencies.)

FCC regulations permit only "transmissions" (one party to another) rather than "broadcasts" (to a wide audience). Thus, advertising is not allowed on CB Channels because that is "broadcasting."



#### "Cuts Static coming in, adds Punch going out!"

Cobra proudly introduces the first Patent Pending technology that dramatically improves the transmission and reception of CB radio signals.

This revolutionary system reconfigures the transmission signal which allows it to be transferred more effectively through cluttered airwaves. It literally "punches" your message through the hundreds of thousands of signals that are in the air. At the same time, **SoundTracker** system dynamically adjusts the relationship between the signal and static commonly referred to as noise. This allows Cobra's **SoundTracker** system to significantly reduce the amount of static on all incoming CB signals. The system can be further optimized when two SoundTracker CB's are used to talk to each other.

The end result is a clearer, cleaner sounding reception of signals and more powerful transmissions which *dramatically* improve CB Communications

All transmitter adjustments other than those supplied by the manufacturer as front panel operating controls, must be made by, or under the supervision of, the holder of an FCC-issued general Radio-Telephone Operator's License.

Replacement or substitution of transistors, regular diodes or other parts of a unique nature, with parts other than those recommended by Cobra, may cause violation of the technical regulations of Part 95 of the FCC Rules, or violation of Type Acceptance requirements of Part 2 of the Rules.

You should read and understand Part 95 (included with this unit) of the FCC Rules and Regulations, before operating your Cobra radio, even though the FCC no longer requires you to obtain an operators license.

**NOTICE:**

Replacement or substitution of transistors, regular diodes or other parts of a unique nature, with parts other than those recommended by Cobra, may cause violation of the technical regulations of Part 95 of the FCC Rules, or violation of Type Acceptance requirements of Part 2 of the Rules.

Citizens Band (CB) Radio operators are no longer required to obtain an FCC license to operate their CB equipment or provide station identification.

An operator of a CB radio station is required to comply with the communications act and with the rules of CB Radio Operation.

## Section I Introduction

### FREQUENCY RANGE

The COBRA 148 GTL ST transceiver represents one of the most advanced SSB/AM two-way radios ever designed for use as a Class D station in the Citizens Radio Service. This unit features advanced Phase Lock Loop (PLL) circuitry, which is used in the AM mode and in the upper and lower single sideband modes, providing complete coverage of all 40 channels shown below.

Channel	Channel Frequency in MHz	Channel	Channel Frequency in MHz
1	26.965	21	27.215
2	26.975	22	27.225
3	26.985	23	27.255
4	27.005	24	27.235
5	27.015	25	27.245
6	27.025	26	27.265
7	27.035	27	27.275
8	27.005	28	27.285
9	27.065	29	27.295
10	27.075	30	27.305
11	27.085	31	27.315
12	27.105	32	27.325
13	27.115	33	27.335
14	27.125	34	27.345
15	27.135	35	27.355
16	27.155	36	27.365
17	27.165	37	27.375
18	27.175	38	27.385
19	27.185	39	27.395
20	27.205	40	27.405

The COBRA 148 GTL ST has a vastly superior receiver which includes an RF gain control and noise blanker circuitry effective in both AM and SSB modes., and an automatic noise limiter effective in the AM mode. The receiver also features increased protection against cross modulation and strong adjacent channel signals.

**To obtain maximum performance please read carefully the descriptions and operating instructions in this manual.**

Serial No. \_\_\_\_\_

Date of Purchase \_\_\_\_\_

Dealer Name \_\_\_\_\_

Keep this manual for detailed information about your Cobra CB radio.

**SAVE YOUR SALES RECEIPT, THE CARTON AND "PACKING" MATERIALS FOR POSSIBLE FUTURE USE.**

## Section II Specifications

### GENERAL

Channels	40 AM, 40LSB, 40 USB.
Frequency Range	26.965 to 27.405 MHz.
Frequency Control	Phase Lock Loop (PLL) synthesizer.
Frequency Tolerance	0.005%
Frequency Stability	0.001%
Operating Temperature Range	-30° C to + 50° C
Microphone	Plug-in dynamic; with push-to-talk switch and coiled cord.
Input Voltage	13.8V DC nominal, 15.9V max., 11.7V min. (positive or negative ground).
Current Drain	<i>Transmit:</i> AM full mod., 2.2A. SSB 12 watts PEP output, 2A. <i>Receive:</i> Squelched, 0.25A Maximum audio output, 0.6A.
Size	2 <sup>3</sup> / <sub>8</sub> "(H) x 7 <sup>7</sup> / <sub>8</sub> "(W) x 9 <sup>1</sup> / <sub>4</sub> "(D).
Weight	5 lbs.
Antenna Conductor	UHF, S0239.
Semiconductors	3 field effect transistors, 45 transistors, 63 diodes, 6 integrated circuits, 1 two color light emitting diode.
Meter (3-in-1)	Illuminated; indicates relative output power, received signal strength, and SWR.

### TRANSMITTER

Power Output	AM, 4 watts. SSB, 12 watts, PEP.
Modulation	High-and low-level Class B, Amplitude Modulation.
Intermodulation Distortion	SSB: 3rd order, more than -25 dB. 5th order, more than -35 dB.
SSB Carrier Suppression	55 dB.
Unwanted Sideband	50 dB.
Frequency Response	AM and SSB; 300 to 2500 Hz.
Output Impedance	50 ohms, unbalanced
Output Indicators	Meter shows relative RF output power and SWR. Transmit LED glows red when transmitter is in operation.

## Section II Specifications (Cont.)

### RECEIVER

Sensitivity	SSB: 0.25 $\mu$ V for 10dB (S+N)/N at greater than 1/2-watt of audio output. AM: 0.5 $\mu$ V for 10 dB (S+N)/ at greater than 1/2-watt of audio output.
Selectivity	AM: 6dB @ 3 KHz, 50 dB @ 9 KHz. SSB: 6 dB @ 1.1 KHz, 60 dB @ 2.3 KHz.
Image Rejection	More than 65 dB.
IF Frequency	AM: 7.8 MHz 1st IF, 455 KHz 2nd IF. SSB: 7.8 MHz.
Adjacent-Channel Rejection	60 dB AM & 70 dB SSB.
AM and SSB RF Gain Control	40 dB adjustable for optimum signal reception.
Automatic Gain Control (AGC)	Less than 10 dB change in audio output for inputs from 10 to 100,000 microvolts.
Squelch	Adjustable; threshold less than 0.25 $\mu$ V.
ANL	Switchable.
Noise Blanker	RF type, effective on AM and SSB.
Voice Lock Range	$\pm$ 2.5 KHz.
Audio Output Power	4 watts into 8 ohms.
Frequency Response	300 to 2500 Hz.
Built-in Speaker	4 ohms, round.
External Speaker (Not Supplied)	8 ohms; disables internal speaker when connected.

### PA SYSTEM

Power Output	4 watts into external speaker.
External Speaker for PA (Not Supplied)	8 ohms.

(SPECIFICATIONS SUBJECT TO CHANGE WITHOUT NOTICE)

## Section III Installation

### LOCATION

Plan the location of the transceiver and microphone bracket before starting the installation. Select a location that is convenient for operation and does not interfere with the driver or passengers in the vehicle. In automobiles, the transceiver is usually mounted below the dash panel, with the microphone bracket beside it.

### MOUNTING THE CONNECTION

The COBRA 148 GTL ST is supplied with a universal mounting bracket. When mounting the bracket and radio to your car, make sure it is mechanically strong. Also provide a good electrical connection to the chassis of the vehicle. Proceed as follows to mount the transceiver:

1. After you have determined the most convenient location in your vehicle, hold the COBRA 148 GTL ST with mounting bracket in the exact location desired. If nothing will interfere with mounting it in the desired position, remove the mounting bolts. Before drilling the holes, make sure nothing will interfere with the installation of the mounting bolts.
2. Connect the antenna cable plug to the standard receptacle on the rear panel. Most CB antennas are terminated with a type PL-259 plug and mate with the receptacle.
3. Connect the red DC power input wire (with the fuse) to +13.8V DC. This wire extends from the rear panel. In automobile installation, +13.8V DC is usually obtained from the accessory contact on the ignition switch. This prevents the set being left on accidentally when the driver leaves the car and also permits operating the unit without the engine running. Locate the accessory contact on most ignition switches by tracing the power wire from the AM broadcast receiver in the car.
4. Connect the black lead to -13.8V DC. This is usually the chassis of the car. Any convenient location with good electrical contact (remove paint) may be used.
5. Mount the microphone bracket on either side of the transceiver, using the two screws supplied. When mounting in an automobile, place the bracket under the dash so the microphone is readily accessible.

## Section III Installation

### IGNITION NOISE INTERFERENCE

Use of a mobile receiver at low signal levels is normally limited by the presence of electrical noise. The primary source of noise in automobile installations is from the generator and ignition system in the vehicle. Under most operating conditions, when signal level is adequate, the background noise does not present a serious problem. Also, when extremely low level signals are being received, the transceiver may be operated with vehicle engine turned off. The unit requires very little current and therefore will not significantly discharge the vehicle battery.

Even though the COBRA 148 GTL ST has ANL and NB controls, in some installations ignition interference may be high enough to make good communications impossible. The electrical noise may come from several sources. Many possibilities exist and variations between vehicles require different solutions to reduce the noise. Consult your COBRA dealer or a 2-way radio technician for help in locating and correcting the source of severe noise.

### ANTENNA

Since the maximum allowable power output of the transmitter is limited by the FCC, the antenna is one important factor affecting transmission distance. Only a properly matched antenna system will allow maximum power transfer from the 50 ohm transmission line to the radiating element. In mobile installations (cars, trucks, boats, etc.), an antenna system that is non-directional should be used. A vertically polarized, quarter-wavelength whip antenna provides the most reliable operation and greatest range. Shorter, loaded-type whip antennas are more attractive, compact and adequate for applications where the maximum possible distance is not required. Also, the loaded whips do not present the problems of height imposed by a full quarter-wavelength whip.

Mobile whip antennas utilize the metal body of the vehicle as a ground plane. When mounted at a corner of the vehicle they are slightly directional, in the direction of the body of the vehicle. For all practical purposes, however, the radiation pattern is nondirectional. The slight directional characteristic will be observed only at extreme distances. A standard antenna connector (type SO239) is provided on the transceiver for easy connection to a standard PL 259 cable termination.

If the transceiver is not mounted on a metal surface, it is necessary to run a separate ground wire from the unit to a good metal electrical ground in the vehicle. When installed in a boat, the transceiver will not operate at maximum efficiency without a ground plate, unless the vessel has a steel hull.

Before installing the transceiver in a boat, consult your dealer for information regarding an adequate grounding system and prevention of electrolysis between fittings in the hull and water.

## Section III Installation (Continued)

### TUNING THE ANTENNA FOR OPTIMUM SWR

Since there is such a wide variety of base and mobile antennas, this section will strictly concern itself to the various types of mobile adjustable antennas. Because antenna length is directly related to the channel frequency, it must be tuned to resonate optimally all 40 channels of the transceiver. Channel 1 requires a longer antenna than Channel 40 because it is a lower frequency.

Due to the various methods of adjusting antennas for proper SWR we have chosen what we think is the optimum method:

#### A. Antennas with adjustable screws (set screws).

1. Start with the antenna extended and tighten the set screw lightly enough so that the antenna can be lightly tapped with your finger for easy adjustment.
2. Set your COBRA 148 GTL ST to Channel 21. Press the PTT (Push-to-Talk) switch, and tap the antenna (making it shorter). The SWR meter will show a lower reading each time the antenna is tapped. By continuing to shorten the antenna you will notice the SWR reading will reach a low point and then start rising again. This means that you have passed the optimum point for Channel 21. Extend the antenna a short distance and again follow the procedure above.

When the lowest point has been reached, switch to Channel 1 and then to Channel 40 and compare SWR readings. They should be almost equal.

#### B. Antennas which must be cut to proper length.

1. Follow the same procedure as above, but adjust the length by cutting in 1/8" increments until a good match is obtained.
2. *Be very careful not to cut too much at one time, as once it is cut, it can no longer be lengthed.*
3. The whip is easily cut by filing a notch all the way around and breaking the piece off with a pliers.

#### NOTE

THE PROPER SETTING IS ACHIEVED WHEN THE SWR IS 1.5 OR BELOW, AND WHEN IT HAS THE SAME READING FOR CHANNELS 1 AND 40.

If you are having difficulties in adjusting your antenna, check the following:

- A. All doors must be closed when adjusting the antenna.
- B. Make sure the antenna base is grounded.
- C. Check your coaxial cable routing (it may be pinched when routed into the car).

## Section III Installation (Continued)

- D. Try a different location on your car (keeping in mind the radiation pattern you wish).
- E. Is the antenna perfectly vertical?
- F. Try a different location in your neighborhood. Stay away from large metal objects when adjusting (metal telephone or light posts, fences, etc.).

### NOTE

The COBRA 148 GTL ST will operate into an SWR of 2 to 1 indefinitely and sustain an SWR of 20:1 for a maximum of 5 minutes at rated operating conditions.

### EXTERNAL SPEAKER

The external speaker jack (EXT. SPK.) on the rear panel is used for remote receiver monitoring. The external speaker should have 8 ohms impedance and be able to handle at least 4 watts. When the external speaker is plugged in, the internal speaker is disconnected.

### PUBLIC ADDRESS

To use the transceiver as a public address system connect an external 8 ohm speaker (4 watts minimum) to the PA SPK. jack located on the rear panel. Direct speaker away from the microphone to prevent acoustic feedback. Physical separation or isolation of the microphone and speaker is important when operating the PA at high output levels.

## Section IV Operation

### CONTROLS AND INDICATORS

There are fourteen controls and four indicators on the front panel of your COBRA 148 GTL ST.

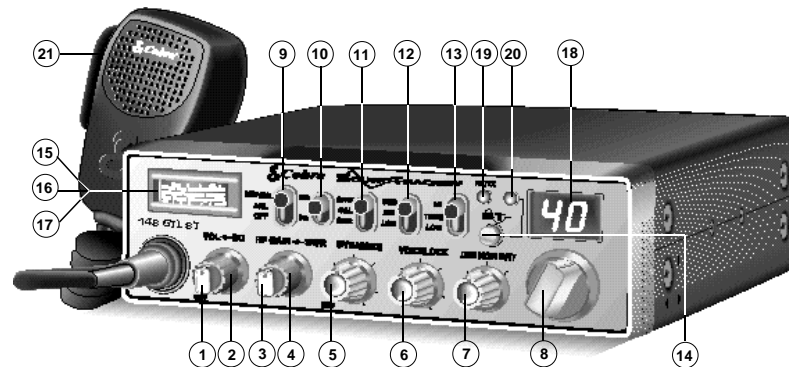

### A. CONTROL FUNCTIONS

1. **OFF/ON/VOLUME (inner concentric dial).** Turn clockwise to apply power to the unit and to set the desired listening level. During normal CB operation, the VOLUME control is used to adjust the output level obtained either at the transceiver speaker or the external speaker, if used.
2. **SQUELCH (outer concentric dial).** This control is used to cut off or eliminate receiver background noise in the absence of an incoming signal. For maximum receiver sensitivity it is desired that the control be adjusted only to the point where the receiver background noise or ambient background noise is eliminated. Turn fully counterclockwise then slowly clockwise until the receiver noise disappears. Any signal to be received must now be slightly stronger than the average received noise. Further clockwise rotation will increase the threshold level which a signal must overcome in order to be heard. Only strong signals will be heard at a maximum clockwise setting.
3. **RF GAIN CONTROL (inner concentric dial).** Used to reduce the gain of the RF amplifier under strong signal conditions.

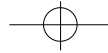

## Section IV Operation (Continued)

4. **SWR CAL CONTROL (outer concentric dial)**. In order for you to achieve maximum radiated power and the longest range, it is important that your antenna be in good condition, properly adjusted and matched to your transceiver. The Built-in SWR (standing wave ratio) meter lets you easily measure your antenna condition. To operate this function, connect your antenna to the transceiver antenna output connector. Select a channel near the middle of the band such as 21 or the channel you plan to use most frequently. Turn the power on and set the meter function switch to the CAL position. Press and hold the microphone push-to-talk button and using the SWR CAL control, adjust the meter to read the CAL position indicated on the meter face. Then, without releasing the microphone button, switch the meter function switch to the SWR position and read the SWR indicated. The lower the figure, the better, with 1 being ideal. Generally speaking, readings up to 3 are acceptable, but over 3 indicates that you are losing radiated power and antenna adjustment may be advisable.
5. **DYNAMIKE**. Adjusts the microphone gain in the transmit and PA modes. This controls the gain to the extent that full talk power is available several inches away from the microphone. In the Public Address (PA) mode the control functions as the volume control.
6. **VOICELOCK**. Allows variation of the receiver operating frequencies above and below the assigned frequency. Although this control is intended primarily to tune in SSB signals, it may also be used to optimize AM signals as described in the Operating Procedure paragraphs.
7. **DIM/NOR/BRT SWITCH**. Controls the brightness of the meter and LED channel indicator for optimum intensity for day or night-time driving.
8. **CHANNEL SELECTOR**. This switch selects any one of the forty Citizens Band or 80 single side band channels desired. The selected channel appears on the LED readout directly above the Channel Selector knob. Channel 9 has been reserved by the FCC for emergency communications involving the immediate safety of life of individuals or immediate protection of property. Channel 9 may also be used to render assistance to a motorist.
9. **OFF/ANL-NB/ANL SWITCH**. In the ANL position only the automatic noise limiter in the audio circuits is activated. When the switch is placed in the ANL + NB position, the RF noise blanker also is activated. The RF noise blanker is very effective for repetitive impulse noise such as ignition interference.

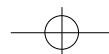

## Section IV Operation (Continued)

10. **PA/CB SWITCH**. Selects the mode of operation. In the CB position, the PA function is disabled and the unit will transmit and receive on the speaker that is connected. In the PA mode, incoming CB transmission will be heard through the PA speaker. This allows you to monitor messages while outside of your vehicle. To use the PA feature, a speaker having a voice coil impedance of 8 ohms and a power handling capability of at least three watts should be used. This speaker must be plugged into the PA SPKR jack at the rear of the transceiver. If the public address feature is to be used primarily for outdoor applications, the use of a weatherproof horn type public address speaker is recommended. The durability of this type speaker plus the inherent efficiency of such a speaker will provide more than adequate results when combined with the high audio output level available from the COBRA 148 GTL ST. With the PA speaker connected as outlined previously, be sure that there is physical separation between the microphone and the speaker itself. If the speaker is located too close to the microphone, acoustic feedback will result when the public address system is operated at high volume. A directional type outdoor speaker reduces the amount of isolation required. Some experimentation will determine the minimum amount of isolation required for a given sound level from the public address system.

### NOTE

PA volume is controlled by adjusting the DYNAMIKE knob to the desired volume.

11. **S-RF/CAL/SWR SWITCH**. When in the S-RF position, the meter swings proportionally to the strength of the received signal. When transmitting, the meter indicates relative RF output power.  
When in the "CAL" position, the SWR meter can be calibrated by adjusting the "SWR" control to the "CAL" mark on the meter face.  
When in "SWR" position, the standing wave ratio is measured.
12. **MODE (USB/AM/LSB) SWITCH**. This switch is used to select AM, LSB or USB mode of operation. Unless the station with which communication is desired is equipped with SSB, the AM mode is normally used. The mode selector switch changes the mode of operation of both transmitter and receiver simultaneously. Turn to "Receiving SSB signals" for a further explanation of single sideband.
13. **TONE SWITCH HI/NOR/LOW**. This switch is used to shape the audio response to the operator's preference. Bass is increased in the LOW position and treble is increased in the HI position.
14. **SOUNDTRACKER™ SWITCH**. Depressing this button turns on the SoundTracker system in your CB.

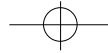

## Section IV Operation (Continued)

### B. INDICATOR FUNCTIONS

15. **S-METER.** Swings proportionally to the strength of the incoming signal.
16. **RF METER.** Swings proportionally to the RF output power.
17. **SWR METER.** Swings proportionally to the ratio of standing wave voltage and RF output. Used to properly adjust the length of the antenna, and to monitor the quality of the coaxial cable and all RF electrical connections. If there is any degradation whatsoever in any of the above, due to humidity, salt, spray, vibration or corrosion, the SWR meter reading will rise, thereby indicating that a problem exists.  
To calibrate, switch to the "CAL" position, transmit in AM Mode by pressing the (PTT) mic switch, and adjust the SWR control to the "CAL" mark on the meter then switch to "SWR" position for the SWR measurement (Note: CB must be in AM mode).
18. **CHANNEL INDICATOR.** Numbered LED indicates the selected channel you wish to operate on.
19. **RECEIVE/TRANSMIT INDICATOR.** The receiver/transmit LED indicator is located next to the channel indicator. When in receive, the LED will be green. When in transmit the LED will be red.
20. **SOUNDTRACKER™ INDICATOR.** A red LED will illuminate when the SoundTracker system is engaged on your CB.
21. **PRESS-TO-TALK MICROPHONE.** The receiver and transmitter are controlled by the Press-To-Talk switch on the microphone. Press the switch and the transmitter is activated, release the switch to receive. When transmitting, hold the microphone two inches from the mouth and speak clearly in a normal "voice". The radio comes complete with low-impedance (500 ohm) dynamic microphone. For installation instructions on the other microphones see ALTERNATE MICROPHONES AND INSTALLATION section.

### OPERATING PROCEDURE TO RECEIVE

1. Be sure that the power source, microphone and antenna are connected to the proper connectors before going to the next step.
2. Set PA-CB Switch to the CB position and turn unit on by turning VOL control clockwise on COBRA 148 GTL ST.
3. Set the VOLUME for a comfortable listening level.
4. Set MODE switch to the desired mode.
5. Set the RF gain control fully clockwise for maximum RF gain.
6. Listen to the background noise from the speaker. Turn the SQUELCH control slowly clockwise until the noise JUST disappears (no signal should be present). Leave the control at this setting. The SQUELCH is now properly adjusted. The receiver will remain quiet until a signal is actually received. Do not advance the control too far, or some of the weaker signals will not be heard.
7. Set the CHANNEL selector switch to the desired channel.
8. Adjust the VOICE LOCK control to clarify the SSB signals or to optimize AM signals.

## Section IV Operation (Continued)

### OPERATING PROCEDURE TO TRANSMIT

1. Select the desired channel of transmission.
2. Set the DYNAMIKE control fully clockwise.
3. If the channel is clear, depress the Push-To-Talk switch on the microphone and speak in a normal voice.

### RECEIVING SSB SIGNALS

There are three types of signals presently used for communications in the Citizens Band: AM, USB, and LSB. When the MODE switch on your unit is placed in the AM position, only standard double-sideband, full carrier signals will be detected. An SSB signal may be recognized while in the AM mode by its characteristic "Donald Duck" sound and the inability of the AM detector to produce an intelligible output. The USB and LSB modes will detect upper sideband and lower sideband respectively, and standard AM signals.

SSB reception differs from standard AM reception in that SSB receiver does not require a carrier or opposite sideband to produce an intelligible signal. A single-sideband transmitted signal consists only of the upper or the lower sideband and no carrier is transmitted. The elimination of the carrier from the AM signal helps to eliminate the biggest cause of whistles and tones heard on channels which make even moderately strong AM signals unreadable. Also, SSB takes only half of an AM channel, therefore two SSB conversations will fit into each channel expanding the 40 AM channels to 80 SSB channels. The reduction in channel space required also helps in the receiver because only *half* of the noise and interference can be received with 100% of the SSB signal.

An SSB signal may be received only when the listening receiver is functioning in the same mode. In other words, an upper sideband signal (USB) may be made intelligible *only* if the receiver is functioning in the USB position.

If a lower sideband (LSB) signal is heard when the receiver is in the USB mode, no amount of tuning will make the signal intelligible. The reason for this may be understood if you consider that when the modulation is applied to the transmitter's microphone in the USB mode, the transmitter's output frequency is increased whereas in the LSB mode the transmitter's output frequency is decreased. The result in listening to the receiver is that when the MODE switch is in the proper position (either USB or LSB), a true reproduction of single tone of modulation will result, and if the tone is increased in frequency (such as a low-pitched whistle or a high-pitched whistle) you will hear the increase in the output tone of the receiver. If the incorrect mode is selected, an increase in tone of a whistle applied to the transmitter will cause a decrease in the resultant tone from the receiver.

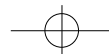



## Section IV Operation (Continued)

Thus when a voice is used in place of a whistle or tone, in the proper listening mode the voice will be received correctly whereas in the incorrect mode, the voice will be translated backwards and cannot be made intelligible by the voice lock control. When listening to an AM transmission, a correct sideband is heard in either mode since both upper and lower sideband are received.

Once the desired SSB mode has been selected, frequency adjustment may be necessary in order to make the incoming signal intelligible, the VOICE LOCK control allows the operator to vary frequency above and below the exact-center frequency of the received signal. If the sound of the incoming signal is high or low pitched, adjust the operation of the VOICE LOCK. Consider it as performing the same function as a phonograph speed control. When the speed is set too high, voices will be high-pitched and if set too low, voices will be low-pitched. Also, there is only *one* correct speed that will make a particular record produce the same sound that was recorded. If the record is played on a turntable that rotates in the wrong direction (opposite sideband) no amount of speed control (VOICE LOCK) will produce an intelligible sound.

An AM signal received while listening in one of the SSB modes will produce a steady tone (carrier) in addition to the intelligence, unless the SSB receiver is tuned to exactly the same frequency by the VOICE LOCK control. For simplicity it is recommended that the AM modes be used to listen to AM signals.

## Section IV Operation (Continued)

### ALTERNATE MICROPHONES AND INSTALLATION

For best results, the user should select a low-impedance dynamic type microphone or a transistorized microphone. Transistorized type microphones have a low output impedance characteristic. The microphones must be provided with a 4-lead cable. The audio conductor and its shielded lead comprise two of the leads. The third lead is for receive control, the fourth is for transmit control.

The microphone should provide the functions shown in schematic below.

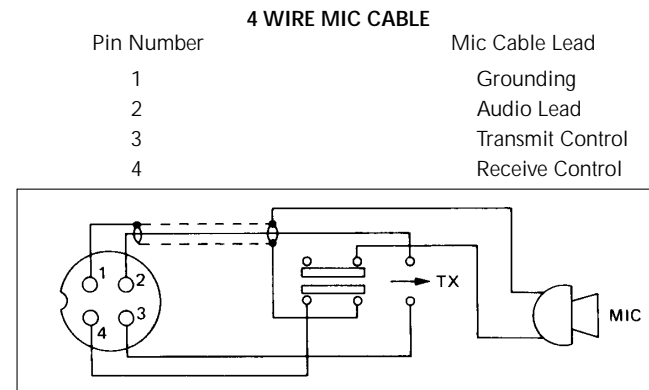

Fig. 1. Cobra 148 GTL ST microphone schematic.

If the microphone to be used is provided with pre-cut leads, they must be revised as follows.

1. Cut leads so that they extend 7/16" beyond the plastic insulating jacket of the microphone cable (see Fig. 2.)
2. All leads should be cut to the same length. Strip the ends of each wire 1/8" and tin the exposed wire.

Before beginning the actual wiring, read carefully, the circuit and wiring information provided with the microphone you select. Use the minimum heat required in soldering the connections. Keep the exposed wire lengths to a minimum to avoid shorting when the microphone plug is reassembled.

## Section IV Operation (Continued)

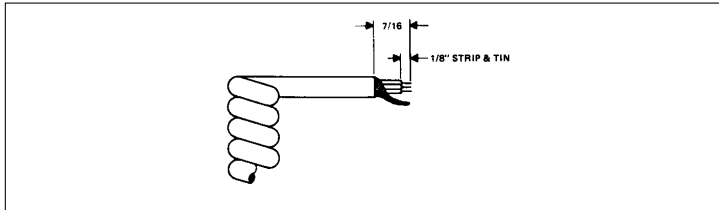

**Fig. 2.** Microphone Cable Preparation

To wire the microphone cable to the plug provided, proceed as follows.

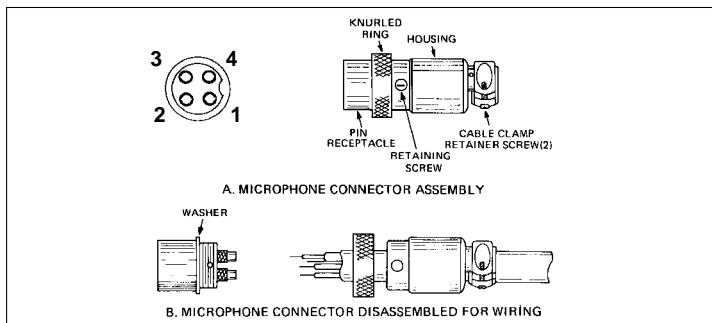

**Fig. 3.** Microphone plug wiring.

1. Remove the retaining screw.
2. Unscrew the housing from the pin receptacle body.
3. Loosen the two cable clamp retainer screws.
4. Feed the microphone cable through the housing, knurled ring and washer as shown Fig. 3B.
5. The wires must now be soldered to the pins as indicated in the above wiring tables. If a vise or clamping tool is available it should be used to hold the pin receptacle body during the soldering operation, so that both hands are free to perform the soldering. If a vise or clamping tool is not available, the pin receptacle body can be held in a stationary position by inserting it into the microphone jack on the front panel. The numbers of the pins of the microphone plug are shown in Fig 4, as viewed from the back of the plug. Before soldering the wire to the pins, pre-tin the wire receptacle of each pin of the plug.

## Section IV Operation (Continued)

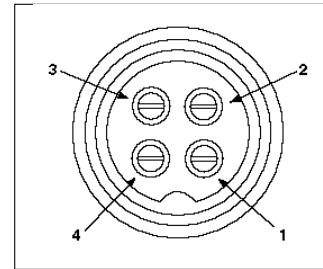

**Fig. 4.** Microphone plug pin numbers viewed from rear of pin receptacle.

Be sure that the housing and the knurled ring of Fig. 3 are pushed back onto the microphone cable before starting to solder. If the washer is not captive to the pin receptacle body, make sure that it is placed on the threaded portion of the pin receptacle body before soldering.

If the microphone jack is used to hold the pin receptacle during soldering operation, best results are obtained when the connections to pins 1 and 3 are made first and then the connections to pins 2 and 4. Use a minimum amount of solder and be careful to prevent excessive solder accumulation on pins, which could cause a short between the pin and the microphone plug housing.

6. When all soldering connections to the pins of the microphone are complete, push the knurled ring and the housing forward and screw the housing onto the threaded portion of the pin receptacle body. Note the location of the screw clearance hole in the plug housing with respect to the threaded hole in the pin receptacle body. When the housing is completely threaded into the pin receptacle body, a final fraction of a turn either clockwise or counterclockwise may be required to align the screw hole with the threaded hole in the pin receptacle body. When these are aligned, the retaining screw is then screwed into place to secure the housing to the pin receptacle body.
7. The two cable clamp retainer screws should now be tightened to secure the housing to the microphone cord. If the cutting directions have been carefully followed, the cable clamp should secure to the insulation jacket of the microphone cable.
8. Upon completion of the microphone plug wiring, connect and secure the microphone plug in the transceiver.

## Section V Maintenance and Adjustment

The COBRA 148 GTL ST transceiver is specifically designed for the environment encountered in mobile installations. The use of all solid state circuitry and its light weight result in high reliability. Should a failure occur, however, replace parts only with identical parts. Do not substitute. Refer to the schematic diagram and parts list.

### NOTE

If the performance described in the OPERATION and MAINTENANCE AND ADJUSTMENT sections is not obtained, review the operating instructions to insure that proper procedures were followed. If a problem still exists, refer to WARRANTY SERVICE INSTRUCTIONS elsewhere in this manual.

### FCC WARNING

Replacement or substitution of transistors, regular diodes or other parts of a unique nature, with parts other than those recommended by Cobra, may cause violation of the technical regulations of Part 95 of the FCC Rules, or violation of Type Acceptance requirements of Part 2 of the Rules.

Citizens Band (CB) Radio operators are no longer required to obtain an FCC license to operate their CB equipment or provide station identification.

Nevertheless, an operator of a CB radio station is still required to comply with the communications act and with the rules of CB Radio Operation.

## How SoundTracker Works

### SOUNDTRACKER SYSTEM

While previous systems only "blanked out" or limited noise in higher sound frequencies, the revolutionary new SoundTracker System actually reduces noise while leaving the signal intact in the reception mode. In the transmission mode, it actually strengthens the signal, providing you with a significant reduction in noise on reception and transmission.

Sound clarity is measured by the ratio of the signal level to the noise level. The higher the signal-to-noise ratio, the better the sound.

### HOW SOUNDTRACKER WORKS

#### On Reception—"Cuts Noise Coming In"

With a normal CB, distant signals fall below the squelch level and are unintelligible. With a SoundTracker CB, the noise level is cut by up to 90%, which increases the signal-to-noise ratio and dramatically improves signal clarity. This also allows you to significantly reduce the squelch level, which greatly expands your listening range.

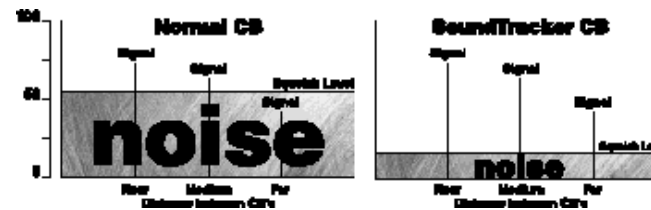

#### On Transmission—"Strengthens Signals Going Out"

A SoundTracker CB strengthens the transmit signal by more effectively using the available RF power output of the CB. The result is improved transmission signal clarity and an expanded transmission range.

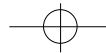

# Activating/Testing SoundTracker

## ACTIVATING SOUNDTRACKER

1. Press the SoundTracker button on the right side of front panel.

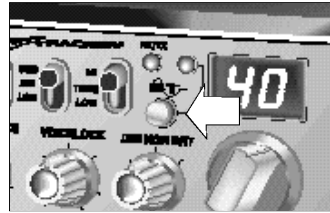

## TESTING SOUNDTRACKER

1. Select any unused channel on your CB.

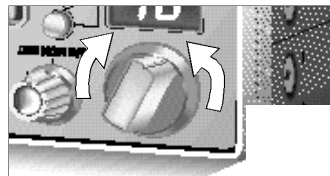

2. Open the squelch fully by turning the knob counter-clockwise until it stops.

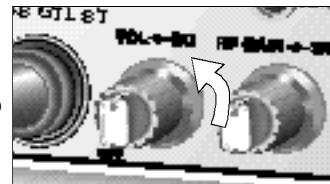

3. Turn the volume up louder than your normal listening level.

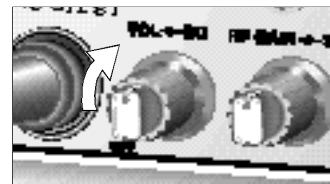

4. Switch the SoundTracker toggle off and on. Notice the significant reduction in noise.



# Section VI Appendix

Citizens Band radio operators have largely adopted the "10-code" for standard questions and answers. Its use permits faster communications and better understanding in noisy areas. The following table lists some of the more common codes and their meanings.

## 10 CODE

Code	Meaning	Code	Meaning
10-1	Receiving poorly	10-36	Correct time is
10-2	Receiving well	10-37	Wrecker needed at
10-3	Stop transmitting	10-38	Ambulance needed at
10-4	OK, message received	10-39	Your message delivered
10-5	Relay message	10-41	Please turn to channel
10-6	Busy, stand by	10-42	Traffic accident at
10-7	Out of service, leaving air	10-43	Traffic Tie up at
10-8	In service, subject to call	10-44	I have a message for you
10-9	Repeat message	10-45	All units within range please report
10-10	Transmission completed, standing by	10-50	Break channel
10-11	Talking too rapidly	10-60	What is the next message number?
10-12	Visitors present	10-62	Unable to copy, use phone
10-13	Advise Weather/Road conditions	10-63	Net directed to
10-16	Make pick up at	10-64	Net clear
10-17	Urgent business	10-65	Awaiting your next message/assignment
10-18	Anything for us?	10-67	All units copy
10-19	Nothing for you, return to base	10-70	Fire at
10-20	My location is	10-71	Proceed with transmission sequence
10-21	Call by telephone	10-77	Negative contact
10-22	Report in person to	10-81	Reserve hotel room for
10-23	Stand by	10-82	Reserve room for
10-24	Completed last assignment	10-84	My telephone number is
10-25	Can you contact	10-85	My address is
10-26	Disregard last information	10-91	Talk closer to mike
10-27	I am moving to channel	10-93	Check my frequency on this channel
10-28	Identify your station	10-94	Please give me a long count
10-29	Time is up for contact	10-99	Mission completed, all units secure
10-30	Does not conform to FCC rules	10-200	Police needed at
10-32	I will give you a radio check		
10-33	EMERGENCY TRAFFIC		
10-34	Trouble at this station		
10-35	Confidential information		

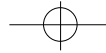

## Section VI Appendix (Continued)

### A FEW RULES THAT SHOULD BE OBEYED

1. You are not allowed to carry on a conversation with another station for more than five minutes at a time without taking a one-minute break, to give others a chance to use the channel.
2. You are not allowed to blast others off the air by over-powering them with illegally amplified transmitter power, or illegally high antennas.
3. You can't use the CB to promote illegal activities.
4. You are not allowed to use profanity.
5. You may not play music in your CB.
6. You may not use your CB to sell merchandise or professional service.

### HOW YOUR CB CAN SERVE YOU

- Warn of traffic tie ups ahead.
- Provide weather and road information.
- Provide help fast in event of emergency or breakdown.
- Suggest good spots to eat and sleep.
- Make long trips more interesting, and help keep you awake.
- Provide direct contact with your office or home.
- Make friends for you as you travel.
- Provide "local information" to find your destination.
- Help law enforcement officers by reporting drunk and reckless drivers.

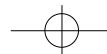

## Section VI Appendix (Continued)

### USE CHANNEL 9 FOR EMERGENCY MESSAGES ONLY

FCC gives the following examples of permitted and prohibited types of communications for use on Channel 9. These are guidelines and are not intended to be all-inclusive.

#### Permitted

Yes

No

Yes

No

Yes

No

Yes

No

Yes

No

#### Example Message

"A tornado sighted six miles north of town."

"This is observation post number 10. No tornado sighted."

"I am out of gas on Interstate 95."

"I am out of gas in my driveway."

There is a four-car collision at Exit 10 on the Beltway, send police and ambulance."

"Traffic is moving smoothly on the Beltway."

"Base to Unit 1, the Weather Bureau has just issued a thunder storm warning. Bring the sailboat into port."

"Attention all motorists. The Weather Bureau advises that the snow tomorrow will accumulate 4 to 6 inches."

"There is a fire in the building on the corner of 6th and Main Streets."

"This is Halloween patrol unit number 3. Everything is quiet here."



## If You Think You Need Service

### If You Think You Need Service, Call 773-889-3087

You may be asked to send your unit to the Cobra factory. It will be necessary to furnish the following, in order to have the product serviced and returned.

1. For Warranty Repair, include some form of proof-of-purchase, such as a mechanical reproduction or carbon or a sales receipt. If you send the original receipt it cannot be returned.
2. Send the entire product. Must include CB unit and microphone.
3. Enclose a description of what is happening with the unit. Include a typed or clearly printed name and address of where the unit is to be returned.
4. Pack unit securely to prevent damage in transit. If possible, use the original packing material.
5. Ship prepaid and insured by way of a traceable carrier (to avoid loss in transit) such as United Parcel Service (UPS), Roadway Parcel Service (RPS) or First Class Insured Mail to Cobra Factory Service, Cobra Electronics Corporation, 6500 W. Cortland St., Chicago, IL 60707. Cobra is not responsible for units not received if package has not been properly insured.
6. If the unit is in warranty, upon receipt of your unit it will either be repaired or exchanged depending on the model. Please allow approximately 3 to 4 weeks before contacting us for status. If the unit is out of warranty a letter will automatically be sent informing you of the repair charge or replacement charge. If you have any questions, please call 773-889-3087 for assistance.

For technical assistance, please call our Automated Help Desk which can assist you by answering the most frequently asked questions about Cobra products.

**(773) 889-3087**

24 hours a day, 7 days a week.

A Consumer Service Representative can be reached through this same number 8:00 am - 8:00 pm, Monday through Friday, CST.

Technical assistance is also available on-line in the Frequently Asked Question (FAQ) section at [www.cobraelec.com](http://www.cobraelec.com) or by e-mail to [productinfo@cobraelec.com](mailto:productinfo@cobraelec.com)

## LIMITED TWO YEAR WARRANTY

**COBRA ELECTRONICS CORPORATION** warrants that its COBRA CB Radios, and the component parts thereof, will be free of defects in workmanship and materials for period of two (2) years from the date of first consumer purchase. This warranty may be enforced by the first consumer purchaser, provided that the product is utilized within the U.S.A.

COBRA will, without charge, repair or replace, at its option, defective CB radios, products or component parts upon delivery to the COBRA factory Service Department, accompanied by proof of the date of first consumer purchase, such as a duplicated copy of a sales receipt.

You must pay any initial shipping charges required to ship the product for warranty service, but the return charges will be at Cobra's expense, if the product is repaired or replaced under warranty. For further details concerning procedures for obtaining service, see the "If You Think You Need Service" section of the Owner's Manual.

**Exclusions:** This limited warranty does not apply: 1) to any product damaged by accident; 2) in the event of misuse or abuse of the product or as a result of unauthorized alterations or repairs; 3) if the serial number has been altered, defaced or removed; 4) if the owner of the product resides outside the U.S.A.

All implied warranties, including warranties of merchantability and fitness for a particular purpose are limited in duration to the length of this warranty.

COBRA shall not be liable for any incidental, consequential or other damages; including, without limitation, damages resulting from loss of use or cost of installation.

Some states do not allow limitations on how long an implied warranty lasts and/or do not allow the exclusion or limitation of incidental or consequential damages, so the above limitations may not apply to you.

**COBRA ELECTRONICS CORPORATION**  
6500 W. Cortland Street  
Chicago, Illinois 60707

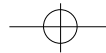

NOTES

**COBRA CB RADIO ACCESSORIES**

Description	Part No.	Cost Ea.	X Qty.	= Amount
Replacement microphone with 4-pin connector for 148 GTL ST	CA-73	\$19.95		
MOBILE POWER MICROPHONE Amplified Power Microphone with 4-pin connector for 148 GTL ST	CA-75	\$19.95		
NOISE CANCEL MICROPHONE for 148 GTL ST	CA-77	\$39.95		
ECHO POWER MICROPHONE or 148 GTL ST	CA-79	\$69.95		
High Performance, Magnetic Mount Antenna. Spring Base, Tunable and 1,000 watt Capacity	ATW-400	\$39.95		
DC POWER CORD Exact replacement power cord for 148 GTL ST	426-011-N-001	\$7.50		
MOUNTING BRACKET Replacement for 148 GTL ST	250-044-N-001	\$4.50		
MOUNTING BRACKET SCREWS for 148 GTL ST	634-188-9-001	\$.25 ea.		

Prices subject to change without notice.

- \*\* Illinois residents add 7%
- \*\* Cook Co. residents add .75% (7.75% total)
- \*\* Chicago residents add 1% (8.75% total)
- \*\* Indiana residents add 5%
- \*\* Michigan residents add 4 %
- \*\* Minnesota residents add 6%
- \*\* Ohio residents add 6%
- \*\* Wisconsin residents add 5%

Amount \_\_\_\_\_  
 (Tax if applicable) \_\_\_\_\_  
 Shipping/handling **\$3.75** \_\_\_\_\_  
 Total \_\_\_\_\_

**If you wish, you can order directly from Cobra**

**Order by phone:**

Call 1-773-889-3087 (Press 1 from the main menu) 8a.m.-8p.m. M-F CST.

**Order by mail or fax:** Please fill out order form below, and mail/fax directly to Cobra.

**Mail to:**

Cobra Accessories Dept.  
 6500 W. Cortland St., Chicago, IL 60707

**Fax to:**

1-773-622-2269

Please print clearly:

Name _____		
Address (Not P.O. Box) _____		
City _____	State _____	Zip _____
Telephone No. (_____) _____		
Credit Card No. _____		Exp. Date _____
Customer Signature _____		
Circle One:    Visa            MasterCard            Discover		

Allow 4 to 6 weeks for delivery. Offer valid in Continental U.S. only.

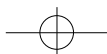

## Free Manuals Download Website

<http://myh66.com>

<http://usermanuals.us>

<http://www.somanuals.com>

<http://www.4manuals.cc>

<http://www.manual-lib.com>

<http://www.404manual.com>

<http://www.luxmanual.com>

<http://aubethermostatmanual.com>

Golf course search by state

<http://golfingnear.com>

Email search by domain

<http://emailbydomain.com>

Auto manuals search

<http://auto.somanuals.com>

TV manuals search

<http://tv.somanuals.com>