

OPERATING INSTRUCTIONS FOR YOUR

**Cobra**<sup>®</sup>  
40 CHANNEL

**SOUNDTRACKER**<sup>™</sup>  
SYSTEM

**CITIZENS BAND  
2-WAY MOBILE RADIO**

Model

**21 LTD ST**

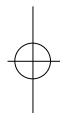

**Cobra**<sup>®</sup>

Cobra Electronics Corporation  
6500 W. Cortland Street  
Chicago, IL 60707



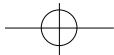

**How To Use Your**  
  
  
**Citizens Band**  
**2-Way Mobile Radio**  
**Model 21 LTD ST**

<b>Contents</b>	<b>Page</b>
<b>The CB Story</b> .....	1
<b>SoundTracker System</b> .....	1
<b>Specifications</b> .....	2,3
<b>Installation</b>	
Location.....	4
Mounting Connections.....	4, 5
CB Antenna .....	6
Ignition Noise Interference .....	7
In House Operation.....	7
<b>Operation</b>	
Controls and Indicators .....	8, 9, 10
Operating Procedure to Receive .....	11
Operating Procedure to Transmit .....	12
How SoundTracker Works.....	13
<b>Maintenance and Adjustment</b> .....	14
<b>Appendix</b>	
Ten Code.....	15
A Few Rules That Should Be Obeyed .....	16
How Your CB Can Serve You .....	16
<b>Warranty Service Instructions</b> .....	17
<b>Limited Two Year Warranty</b> .....	18
<b>Accessories</b> .....	Inside Back Cover

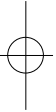

## The CB Story

The Citizens Band lies between the shortwave broadcast and 10-meter Amateur radio bands, and was established by law in 1949. The Class D two-way communications service was opened in 1959. (CB also includes a Class A citizens band and Class C remote control frequencies.)

FCC regulations permit only "transmissions" (one party to another) rather than "broadcasts" (to a wide audience). Thus, advertising is not allowed on CB Channels because that is "broadcasting."



**"Cuts Static coming in, adds Punch going out!"**

Cobra proudly introduces the first Patent Pending technology that dramatically improves the transmission and reception of CB radio signals.

This revolutionary system reconfigures the transmission signal which allows it to be transferred more effectively through cluttered airwaves. It literally "punches" your message through the hundreds of thousands of signals that are in the air. At the same time, **SoundTracker** system dynamically adjusts the relationship between the signal and static commonly referred to as noise. This allows Cobra's **SoundTracker** system to significantly reduce the amount of static on all incoming CB signals. The system can be further optimized when two SoundTracker CB's are used to talk to each other.

The end result is a clearer, cleaner sounding reception of signals and more powerful transmissions which *dramatically* improve CB Communications

All transmitter adjustments other than those supplied by the manufacturer as front panel operating controls, must be made by, or under the supervision of, the holder of an FCC-issued general Radio-Telephone Operator's License. Replacement or substitution of transistors, regular diodes or other parts of a unique nature, with parts other than those recommended by Cobra, may cause violation of the technical regulations of Part 95 of the FCC Rules, or violation of Type Acceptance requirements of Part 2 of the Rules. You should read and understand Part 95 (included with this unit) of the FCC Rules and Regulations, before operating your Cobra radio, even though the FCC no longer requires you to obtain an operators license.

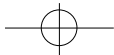

# Specifications

## FREQUENCY RANGE

The COBRA21 LTD ST transceiver represents one of the most advanced AM two-way radios ever designed for use as a Class D station in the Citizens Radio Service. This unit features advanced Phase Lock Loop (PLL) circuitry providing complete coverage of all 40 channels as shown below.

Channel	Channel Frequency in MHz	Channel	Channel Frequency in MHz
1	26.965	21	27.215
2	26.975	22	27.225
3	26.985	23	27.255
4	27.005	24	27.235
5	27.015	25	27.245
6	27.025	26	27.265
7	27.035	27	27.275
8	27.055	28	27.285
9	27.065	29	27.295
10	27.075	30	27.305
11	27.085	31	27.315
12	27.105	32	27.325
13	27.115	33	27.335
14	27.125	34	27.345
15	27.135	35	27.355
16	27.155	36	27.365
17	27.165	37	27.375
18	27.175	38	27.385
19	27.185	39	27.395
20	27.205	40	27.405

The COBRA21 LTD ST has a vastly superior receiver which includes noise blanker circuitry and an automatic noise limiter. The receiver also features increased protection against cross modulation and strong adjacent channel signals.

**To obtain maximum performance please read carefully the descriptions and operating instructions in this manual. Fill out below; keep for your records.**

Serial No. \_\_\_\_\_

Date of Purchase \_\_\_\_\_

Dealer Name \_\_\_\_\_

Keep this manual for detailed information about your Cobra CB radio.

**SAVE YOUR SALES RECEIPT, CARTON AND PACKING FOR POSSIBLE FUTURE USE.**

# Specifications (cont.)

## GENERAL

Channels	40
Frequency Range	26.965 to 27.405 MHz.
Frequency Control	Phase Lock Loop (PLL) synthesizer.
Frequency Tolerance	0.005%.
Operating Temperature Range	-30° C to + 50° C.
Microphone	Plug-in dynamic.
Input Voltage	13.8VDC nom.(positive or negative ground).
Current Drain	Transmit: AM full mod., 1.5A(maximum) Receive: Squelched, 0.3A; full audio output, 1.2A (nominal).
Size	5 3/4" W x 1 3/4" H x 7 1/2" D.
Weight	1.2 lbs.
Antenna Connector	UHF, SO-239.
Semiconductors	26 transistors, 26 diodes, 4 integrated circuits.
Meter	Illuminated; indicates relative power output and received signal strength.

## TRANSMITTER

Power Output	4 watts.
Modulation	AM (Amplitude Modulation).
Frequency Response	300 to 3000 Hz.
Output Impedance	50 ohms, unbalanced.

## RECEIVER

Sensitivity	Less than 1 μV for 10dB (S+N)/N.
Selectivity	6dB @ 7 KHz, 60 dB @ 10 KHz.
Image Rejection	80 dB, typical.
Adjacent-Channel Rejection	60 dB, typical.
IF Frequencies	Double Conversion: 1st: 10.695 MHz. 2nd: 455 KHz.

Automatic Gain Control (AGC) Less than 10 dB change in audio output for inputs from 10 to 50,000 microvolts.

RF Gain Control	Adjustable for optimum signal reception.
Noise Blanker	RF type.
Squelch	Adjustable; threshold less than 1μV.
Audio Output Power	4 watts.
Frequency Response	300 to 3000 Hz.
Distortion	Less than 7% @ 3 watts @ 1000 Hz.
Built-in Speaker	16 ohms, round.
External Speaker (Not Supplied)	8 ohms; disables internal speaker when connected.

## PA SYSTEM

Power Output	4 watts into external speaker.
External Speaker for PA (Not Supplied)	8 ohms, when PA-CB switch is in PA, the PA speaker also monitors the receiver; separate jack provided.

(SPECIFICATIONS SUBJECT TO CHANGE WITHOUT NOTICE)

## Installation

### Location

Plan the location of the transceiver and microphone bracket before starting the installation. Select a location that is convenient for operation and does not interfere with the driver or passengers in the vehicle. In automobiles, the transceiver is usually mounted to the underneath of the dash panel, with the microphone bracket beside it.

### Mounting and Connection

The transceiver is held in the universal mounting bracket by two thumbscrews, permitting adjustment at the most convenient angle.

A universal mounting bracket is supplied along with self tapping screws and star washers. The mounting must be mechanically strong and also provide a good electrical connection to the chassis of the vehicle. To mount the transceiver:

1. Determine the most convenient location in your vehicle, hold the COBRA radio with mounting bracket in the exact location desired. If nothing will interfere with mounting it in the desired position, remove the mounting bracket and use it as a template to mark the location for the mounting screws.
2. Drill necessary holes and secure mounting bracket in location.

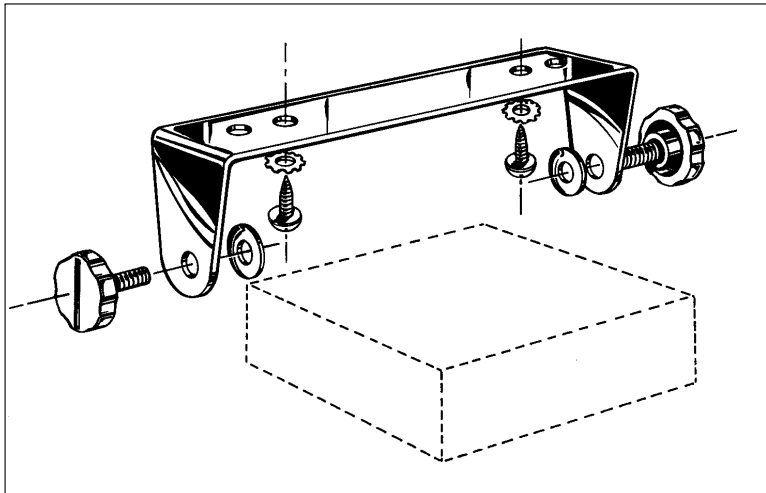

4

## Installation (Cont.)

3. Connect the antenna cable plug to the standard receptacle on the unit. Most CB antennas are terminated with a type PL-259 plug which mates with the receptacle marked "ANT."
4. Connect the red lead of DC power cord to +13.8 VDC. In automobile installations, +13.8 VDC is usually obtained from the accessory contact in the fuse box. This prevents the set being left on accidentally and also permits operating the unit without the vehicle's engine running.

**Before installing the CB radio, visually check the vehicle battery connections to determine which battery terminal, positive or negative (positive is the larger of the two) is grounded to the engine block (or chassis).**

5. Connect the black lead to the negative side of the automobile. This is usually the chassis of the car. Any convenient location with good electrical contact (remove paint) may be used. Plug power cable into jack on back of transceiver.

**In positive ground automobiles the red wire goes to the chassis and the black wire is connected to the ignition switch.**

6. Mount microphone bracket on right side of the transceiver, or near it using two screws supplied. When mounting in an automobile, place the bracket under the dash so the microphone is readily accessible.

5

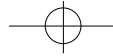

## Installation (Cont.)

### CB Antenna

Since the maximum allowable power output of the transmitter is limited by the FCC, the antenna is one important factor affecting transmission distance. Only a properly matched antenna system will allow maximum power transfer from the 50 ohm transmission line to the radiating element. In mobile installations (cars, trucks, boats, etc.), an antenna system that is non-directional should be used.

A vertically polarized, quarter-wavelength whip antenna provides the most reliable operation and greatest range. Shorter, loaded-type whip antennas are more attractive, compact and adequate for applications where the maximum possible distance is not required. Also, the loaded whips do not present the problems of height imposed by a full quarter-wavelength whip.

Mobile whip antennas utilize the metal body of the vehicle as a ground plane. When mounted at a corner of the vehicle they are slightly directional, in the direction of the body of the vehicle. For all practical purposes, however, the radiation pattern is nondirectional. The slight directional characteristic will be observed only at extreme distances. A standard antenna connector (type SO-239) is provided on the transceiver for easy connection to a standard PL 259 cable termination. Cobra loaded type antenna models are highly recommended for most installations. Consult your Cobra dealer for further details, or call 773-889-3087 and speak to a Cobra customer representative.

**When installed in a boat**, the transceiver will not operate at maximum efficiency without a ground plate, unless the vessel has a steel hull. Before installing the transceiver in a boat, consult your dealer for information regarding an adequate grounding system and prevention of electrolysis between fittings in the hull and water.

**3-Way Combination Antennas** are available which allow operation of all three bands (AM-FM & CB), using a single antenna. However, use of this type of antenna usually results in less than normal transmit and receive range when compared to a standard-type "Single Band" antenna designed for CB only. The quality of reception of radio signals is highly dependent on the antenna system. Call 773-889-3087 for further information.

## Installation (Cont.)

### Ignition Noise Interference

Use of a mobile receiver at low signal levels is normally limited by the presence of electrical noise. The primary source of noise in automobile installations is from the alternator and ignition system in the vehicle. Under most operating conditions, when signal level is adequate, the background noise does not present a serious problem. Also, when extremely low level signals are being received, the transceiver may be operated with vehicle engine turned off. The unit requires very little current and therefore will not significantly discharge the vehicle battery.

Even though the COBRA21 LTD ST has an automatic noise limiter, in some installations ignition interference may be high enough to make good communications impossible. The electrical noise may come from several sources. Many possibilities exist and variations between vehicles require different solutions to reduce the noise. Consult your COBRAdealer or a 2-way radio technician for help in locating and correcting the source of severe noise.

### Base Station Operation (Operation from 120VAC, House Current)

To operate your transceiver from your home or office, using the regular house current as the power source, you will require a 12 VDC power pack that has been specially designed for the purpose. It is available as optional equipment from your COBRAdealer. It consists of a 120-volt, 60 Hz AC to 12-volt DC power converter that delivers the required power for the operation of the transceiver. Simply connect the red (+) and black (-) leads of the transceiver to the corresponding terminals of the power packs.

**DO NOT ATTEMPT TO OPERATE THIS TRANSCEIVER BY CONNECTING DIRECTLY TO 120 VAC.**

### Temporary Mobile Operation

To operate your COBRA transceiver from a car on a temporary basis, you may want to purchase an optional cigar lighter adapter from your COBRAdealer. This adapter and a magnetic mount antenna allow you to quickly "install" your transceiver for temporary use.

## Operation

### Controls and Indicators

Refer to controls, indicators and connectors as illustrated below:

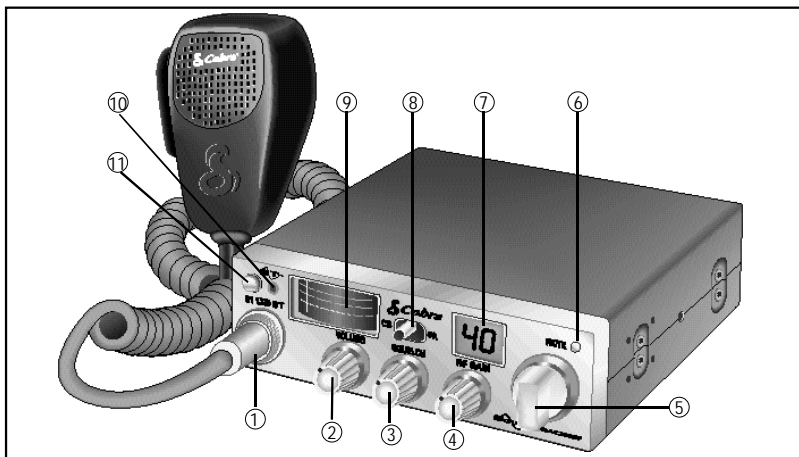

#### A. Front Panel

1. **MICROPHONE CONNECTOR.** Front panel microphone connector.
2. **OFF/ON/VOLUME.** Turn clockwise to turn power on and set the desired listening volume.
3. **SQUELCH.** This control is used to cut off or eliminate receiver background noise in the absence of an incoming signal. For maximum receiver sensitivity it is desired that the control be adjusted only to the point where the receiver background noise or ambient background noise is eliminated. Adjust until the receiver noise disappears. This will require the incoming signal to be slightly stronger than the average receiver noise. Further clockwise rotation will increase the threshold level which a signal must overcome in order to be heard. Only strong signals will be heard at a maximum clockwise setting.
4. **RF GAIN.** Adjust as required to optimize signal. This control is used primarily to optimize reception in strong signal areas. Gain is reduced by counterclockwise rotation of the control.
5. **CHANNEL SELECTOR SWITCH.** This switch selects any one of forty Citizens Band channels desired. The selected channel is indicated by the LED readout, directly above the channel selector knob.

## Operation (Cont.)

6. **RX/TX LED INDICATOR.** When your radio is in the CB receive mode, the LED will be green. When in transmit mode, the LED will be red.
7. **LED CHANNEL DISPLAY.** The selected channel will be displayed.
8. **CB-PA SWITCH:** Selects the mode of operation. In the CB position, the PA function is disabled and the unit will transmit and receive on the selected frequency. The PA function should not be used unless a PA speaker is connected. **NOTE:** ANL (Automatic Noise Limiter) is a non-switchable feature that is always on to reduce background noise.
9. **S-METER.** Swings proportionally to the strength of the incoming signal during receiving.  
  
**RF-METER.** Swings proportionally to the RF output power while transmitting.
10. **SOUNDTRACKER™ INDICATOR.** A red LED will illuminate when the SoundTracker system is engaged on your CB.
11. **SOUNDTRACKER™ SWITCH.** Depressing this button turns on the SoundTracker system in your CB.

## Operation (Cont.)

### B. Press-To-Talk Microphone

Both the receiver and transmitter are controlled by the Press-to-Talk switch on the microphone. Press the switch and the transmitter is activated; release the switch to receive. When transmitting, hold the microphone two inches from the mouth and speak clearly in a normal voice. The microphone provided with your radio is a detachable low-impedance dynamic type.

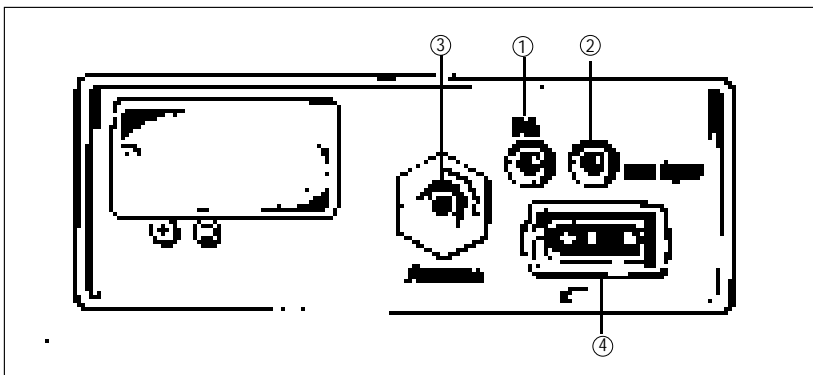

### C. Rear Panel

1. **PUBLIC ADDRESS:** An external 8-ohm 4.0 watt PA speaker may be connected to the PA Speaker Jack when this unit is used as a public address system. The speaker should be directed away from the microphone to prevent acoustic feed-back. Physical separation or isolation of the microphone and speaker must be employed when operating the PA at high output levels.
2. **EXTERNAL SPEAKER:** The External Speaker Jack is used for remote receiver monitoring. The external speaker should have 8-ohm impedance and be rated to handle at least 4.0 watts. When the external speaker is plugged in, the internal speaker is automatically disconnected.
3. **ANTENNA CONNECTOR:** This SO-239 connector permits connection of the transmission line cable PL-259 connector to the transceiver.
4. **POWER.** This jack permits connection of the DC power to the transceiver. A power cord with polarized plug is supplied with the radio. The polarized plug ensures that the power will always be connected properly.

## Operation (Cont.)

### Operating Procedure to Receive

1. Be sure that the power cord, antenna and microphone are connected to the proper connectors before proceeding further. The PA/CB should be in the CB position.
2. Turn the radio ON by rotating the VOLUME CONTROL clockwise.
3. Set the RF GAIN CONTROL fully clockwise.
4. Set DELTA-TUNE CONTROL to center (click-stop) position.
5. Rotate SQUELCH CONTROL counterclockwise until incoming signal is heard.
6. Set the CHANNEL SELECTOR Switch to the desired channel.
7. Set VOLUME CONTROL to a comfortable listening level.
8. Engage the SoundTracker system by depressing the button labeled ST.

Listen to the background noise from the speaker. Turn the SQUELCH CONTROL slowly clockwise until the noise *JUST* disappears (no signal should be present). Leave the control at this setting. The squelch is now properly adjusted. The receiver will remain quiet until a signal is actually received. Do not advance the control too far, or some of the weaker signals will not be heard. The revolutionary SoundTracker system allows you to reduce unwanted background noise (static) and increase the signal for better reception.

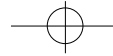

## Operation (Cont.)

### Operating Procedure to Transmit

1. Be sure the operator has read and understands part 95, F.C.C. Rules and Regulations prior to operating the transmitter.
2. Select the desired channel.
3. Set the DYNAMIKE control fully clockwise.
4. The receiver and transmitter are controlled by the press-to-talk switch on the microphone. Press the switch and the transmitter is activated; release switch to receive. When transmitting (on a clear channel), hold the microphone two inches from the mouth and speak clearly in a normal voice.

**Be sure the antenna is properly connected to the radio before transmitting. Prolonged transmitting without an antenna, or a poorly matched antenna, could cause damage to the transmitter.**

### Operating Procedure for Public Address

1. Connect a PA speaker to the PA jack provided on the rear panel.
2. Place PA/CB/ANL switch into the PA position.
3. Depress push-to-talk switch on mic—speak in normal voice.
4. Adjust PA speaker volume with front panel DYNAMIKE control.

**When the Volume control is rotated clockwise, activity on the CB channel will be heard through the PA speaker.**

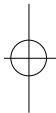

## How SoundTracker Works

### SOUNDTRACKER SYSTEM

While previous systems only “blanked out” or limited noise in higher sound frequencies, the revolutionary new SoundTracker System actually reduces noise while leaving the signal intact in the reception mode. In the transmission mode, it actually strengthens the signal, providing you with a significant reduction in noise on reception and transmission.

**Sound clarity is measured by the ratio of the signal level to the noise level. The higher the signal-to-noise ratio, the better the sound.**

### HOW SOUNDTRACKER WORKS

#### On Reception—“Cuts Noise Coming In”

With a normal CB, distant signals fall below the squelch level and are unintelligible. With a SoundTracker CB, the noise level is cut by up to 90%, which increases the signal-to-noise ratio and dramatically improves signal clarity. This also allows you to significantly reduce the squelch level, which greatly expands your listening range.

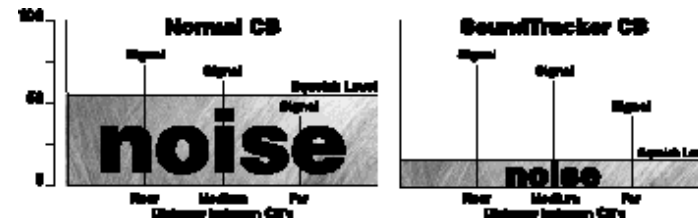

#### On Transmission—“Strengthens Signals Going Out”

A SoundTracker CB strengthens the transmit signal by more effectively using the available RF power output of the CB. The result is improved transmission signal clarity and an expanded transmission range.

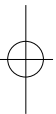



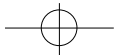

# Maintenance and Adjustment

The COBRA CB transceiver is specifically designed for the environment encountered in mobile installations. The use of all solid state circuitry and its light weight result in high reliability. Should a failure occur, however, review the following, then if necessary, replace parts only with identical parts. Do not substitute. Refer to the schematic diagram and parts.

1. Check connections to the source of power and make sure it is the 13.8 VDC required to operate your radio.
2. Check the fuse in the DC power cord. The main power lead (red wire) has a 2 Amp 3AG type fuse in its holder. Use only the above specified type and size fuse for maximum protection. Failure to do so, will void the warranty.
3. Make certain the microphone is properly plugged in.
4. Make certain the antenna is properly connected and tuned for minimum SWR. **NOTE:** COBRA antennas include full instructions as to how to tune your antenna. If you're still in doubt about the procedure, contact the COBRA dealer from whom you purchased your radio and antenna, for advice. If you hired an installer to install your radio and antenna, contact the installer.

If you are unable to correct the problem, refer the WARRANTY SERVICE INSTRUCTIONS at the end of this manual for the correct procedure for warranty and post-warranty service from COBRA.

### Adjustment Warning

Replacement or substitution of certain parts with replacements other than those recommended by COBRA, may be a violation of the technical regulations of Part 95 of the FCC Rules, or of Type Acceptance requirements of Part 2 of said rules.

When making adjustments other than transmitter adjustments, be sure to re-read applicable portions of this instruction manual to make certain you are following correct procedure and that the radio was properly installed, etc.

**For technical assistance, please call our Automated Help Desk which can assist you by answering the most frequently asked questions about Cobra products.**  
**(773) 889-3087**  
 24 hours a day, 7 days a week.

**A Consumer Service Representative can be reached through this same number 8:00 am - 8:00 pm, Monday through Friday, CST.**

**Technical assistance is also available on-line in the Frequently Asked Question (FAQ) section at [www.cobraelec.com](http://www.cobraelec.com) or by e-mail to [productinfo@cobraelec.com](mailto:productinfo@cobraelec.com)**

# Appendix

Citizens Band radio operators have largely adopted the "10-code" for standard questions and answers. Its use permits faster communications and better understanding in noisy areas. The following table lists some of the more common codes and their meanings:

Code	Meaning	Code	Meaning
10-1	Receiving poorly	10-35	Confidential information
10-2	Receiving well	10-36	Correct time is
10-3	Stop transmitting	10-37	Wrecker needed at
10-4	OK, message received	10-38	Ambulance needed at
10-5	Relay message	10-39	Your message delivered
10-6	Busy, stand by	10-41	Please turn to channel
10-7	Out of service, leaving air	10-42	Traffic accident at
10-8	In service, subject to call	10-43	Traffic Tie up at
10-9	Repeat message	10-44	I have a message for you
10-10	Transmission completed, standing by	10-45	All units within range please report
10-11	Talking too rapidly	10-50	Break channel
10-12	Visitors present	10-60	What is next message number?
10-13	Advise Weather/Road conditions	10-62	Unable to copy, use phone
10-16	Make pick up at	10-63	Net directed to
10-17	Urgent business	10-64	Net clear
10-18	Anything for us?	10-65	Awaiting your next message/assignment
10-19	Nothing for you, return to base	10-67	All units copy
10-20	My location is	10-70	Fire at
10-21	Call by telephone	10-71	Proceed with transmission in sequence
10-22	Report in person to	10-77	Negative contact
10-23	Stand by	10-81	Reserve hotel room for
10-24	Completed last assignment	10-82	Reserve room for
10-25	Can you contact	10-84	My telephone number is
10-26	Disregard last information	10-85	My address is
10-27	I am moving to channel	10-91	Talk closer to mike
10-28	Identify your station	10-93	Check my frequency on this channel
10-29	Time is up for contact	10-94	Please give me a long count
10-30	Does not conform to FCC rules	10-99	Mission completed, all units secure
10-32	I will give you a radio check	10-200	Police needed at
10-33	EMERGENCY TRAFFIC		
10-34	Trouble at this station		

## Appendix (Cont.)

### A Few Rules That Should Be Obeyed

1. You are not allowed to carry on a conversation with another station for more than five minutes at a time without taking a one-minute break to give others a chance to use the channel.
2. You are not allowed to blast others off the air by overpowering them with illegally amplified transmitter power or illegally high antennas.
3. You can't use the CB to promote illegal activities.
4. You are not allowed to use profanity.
5. You may not play music in your CB.
6. You may not use your CB to sell merchandise or professional service.

### How Your CB Can Serve You

- Warn of traffic tie ups ahead.
- Provide weather and road information.
- Provide help fast in event of emergency or breakdown.
- Suggest good spots to eat and sleep.
- Make long trips more interesting, and help keep you awake.
- Provide direct contact with your office or home.
- Make friends for you as you travel.
- Provide "local information" to find you destination.
- Help law enforcement officers by reporting drunk and reckless drivers.

## If You Think You Need Service

### If You Think You Need Service, Call 773-889-3087

**"If your product should require factory service please call Cobra first before sending your unit in. This will ensure the fastest turnaround time on your repair."**

You may be asked to send your unit to the Cobra factory. It will be necessary to furnish the following, in order to have the product serviced and returned.

1. For Warranty Repair, include some form of proof-of-purchase, such as a mechanical reproduction or carbon or a sales receipt. If you send the original receipt it cannot be returned.
2. Send the entire product. Must include CB unit and microphone.
3. Enclose a description of what is happening with the unit. Include a typed or clearly printed name and address of where the unit is to be returned.
4. Pack unit securely to prevent damage in transit. If possible, use the original packing material.
5. Ship **prepaid and insured by way of a traceable carrier** (to avoid loss in transit) such as **United Parcel Service (UPS), Roadway Parcel Service (RPS) or First Class Insured Mail to Cobra Factory Service, Cobra Electronics Corporation, 6500 W. Cortland St., Chicago, IL60707. Cobra is not responsible for units not received if package has not been properly insured.**
6. If the unit is in warranty, upon receipt of your unit it will either be repaired or exchanged depending on the model. Please allow approximately 3 to 4 weeks before contacting us for status. If the unit is out of warranty a letter will automatically be sent informing you of the repair charge or replacement charge. If you have any questions, please call 773-889-3087 for assistance.

**For technical assistance, please call our Automated Help Desk which can assist you by answering the most frequently asked questions about Cobra products.**

**(773) 889-3087**

**24 hours a day, 7 days a week.**

**A Consumer Service Representative can be reached through this same number 8:00 am - 8:00 pm, Monday through Friday, CST.**

**Technical assistance is also available on-line in the Frequently Asked Question (FAQ) section at [www.cobraelec.com](http://www.cobraelec.com) or by e-mail to [productinfo@cobraelec.com](mailto:productinfo@cobraelec.com)**

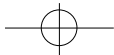

# Warranty and Service

## Limited Two Year Warranty

COBRAELECTRONICS CORPORATION warrants that its COBRACitizens band (CB) radio, and the component parts thereof, will be free of defects in workmanship and materials for period of two (2) year from the date of first consumer purchase. This warranty may be enforced by the first consumer purchaser, provided that the product is utilized within the U.S.A.

COBRA will, without charge, repair or replace, at its option, defective citizens band (CB) products or component parts upon delivery to the COBRA factory Service Department, accompanied by proof of the date of first consumer purchase, such as a duplicated copy of a sales receipt.

You must pay any initial shipping charges required to ship the product for warranty service. The return charges will be at Cobra's expense, if the product is repaired or replaced under warranty. For further details concerning procedures for obtaining service, see the "If You Need Service" section of the Owner's Manual.

**Exclusions:** This limited warranty does not apply; 1) to any product damaged by accident; 2) in the event of misuse or abuse of the product or as a result of unauthorized alterations or repairs; 3) if the serial number has been altered, defaced or removed; 4) if the owner of the product resides outside the U.S.A.

**All implied warranties, including warranties of merchantability and fitness for a particular purpose are limited in duration to the length of this warranty.**

**COBRA shall not be liable for any incidental, consequential or other damages; including, without limitation, damages resulting from loss of use or cost of installation.**

**Some states do not allow limitations on how long an implied warranty lasts and/or do not allow the exclusion or limitation of incidental or consequential damages, so the above limitations may not apply to you.**

**This limited warranty gives you specific legal rights, and you may also have other rights which vary from state to state.**

**Cobra Electronics Corporation,  
6500 W. Cortland Street, Chicago, IL60707**

## OPTIONAL ACCESSORIES

You can find these fine accessories at your local Cobra CB dealer.

Description	Part No.	Cost Ea.	X Qty.	=	Amount
<b>DYNAMIC MICROPHONE</b> Replacement microphone with 4-pin screw-on connector	CA-73	\$14.95			
<b>DC POWER CORD</b> Exact replacement	420-002-N-001	\$7.00			
<b>MOUNTING BRACKET</b> Exact replacement	250-004-N-001	\$4.50			
<b>MOUNTING BRACKET SCREWS</b> Exact replacements	634-088-9-001	\$ .60 ea			
<b>POWER MICROPHONE</b> Amplified power mic	CA-75	\$19.95			
<b>POWER/NOISE-CANCELLING MICROPHONE</b> Amplified power mic with noise-cancelling design	CA-77	\$39.95			
<b>POWER/ECHO MICROPHONE</b> Amplified power mic with echo circuitry	CA-79	\$69.95			
<b>ATW-400</b> High performance magnetic mount antenna	ATW-400	\$39.95			

(Prices subject to change without notice)

- \*\* Illinois residents add 7%
  - \*\* Cook Co. residents add .75% (7.75% total)
  - \*\* Chicago residents add 1% (8.75% total)
  - \*\* Indiana residents add 5%
  - \*\* Michigan residents add 4 %
  - \*\* Ohio residents add 6%
  - \*\* Wisconsin residents add 5%

Amount \_\_\_\_\_  
(Tax if applicable ) \_\_\_\_\_  
Shipping//handling **\$3.75** \_\_\_\_\_  
Total \_\_\_\_\_

**If you wish, you can order directly from Cobra**

**Order by phone:**

Call 1-773-889-3087 (Press 1 from the main menu) 8a.m.-8p.m. M-F CST.

**Order by mail or fax:** Please fill out order form below, and mail/fax directly to Cobra.

**Mail to:**  
Cobra Accessories Dept.  
6500 W. Cortland St., Chicago, IL 60707

**Fax to:**  
1-773-622-2269

**Make check or money order (no stamps) payable to Cobra Electronics and mail with this order form to:**

**Cobra Accessories Dept.  
6500 W. Cortland St., Chicago, IL 60707  
Call 773-889-3087, or fax 773-622-2269 for credit card orders  
Allow 4 to 6 weeks for delivery. Offer valid in Continental U.S. only.**

**Please print clearly:**

**Name** \_\_\_\_\_

**Address (Not P. O. Box)** \_\_\_\_\_

**City** \_\_\_\_\_ **State** \_\_\_\_\_ **Zip** \_\_\_\_\_

**Telephone No. ( \_\_\_\_\_ )** \_\_\_\_\_

**Credit Card No.** \_\_\_\_\_ **Exp. Date** \_\_\_\_\_

**Customer Signature** \_\_\_\_\_

Circle One:      **Visa**                      **MasterCard**                      **Discover**

## Free Manuals Download Website

<http://myh66.com>

<http://usermanuals.us>

<http://www.somanuals.com>

<http://www.4manuals.cc>

<http://www.manual-lib.com>

<http://www.404manual.com>

<http://www.luxmanual.com>

<http://aubethermostatmanual.com>

Golf course search by state

<http://golfingnear.com>

Email search by domain

<http://emailbydomain.com>

Auto manuals search

<http://auto.somanuals.com>

TV manuals search

<http://tv.somanuals.com>