

### Before you begin

Read all instructions before set up.

- Select a level site clear of rocks, branches, and other hard or sharp objects, to install your shelter.
- ⚠ **WARNING: Keep clear of overhead power lines.**
- Do not set up your shelter under trees because of potential lightning strikes or falling tree limbs in inclement weather.
- Secure with **all** stakes and guylines provided to prevent property damage or personal injury.
- For best results in windy conditions, position narrow end of shelter into the wind.
- Do not drop shelter.
- Do not bounce shelter bag on its end to remove shelter, as these actions may damage the frame.
- THIS RECREATIONAL PRODUCT REQUIRES A MINIMUM OF TWO PEOPLE TO ASSEMBLE.
- Under no circumstances should this product be used to cover automobiles, marine products or similar items.

**CAUTION:** Avoid pinch points when opening and closing the shelter frame.

### Replacement Parts List

Description	Part Number
Shelter Top	5010000768

## 1 Extend the Shelter Frame

- With two persons standing at diagonal corners of the structure, grab the leg, and pull out to unfold frame. (Fig. 1)
- NOTE: Do not unfold frame completely. This will allow easier fit for draping shelter top over frame.



Fig. 1

## 2 Set up the Shelter

- Drape shelter top over frame. (Fig. 2)
- Attach hook and loop fasteners, located on corners of shelter top, to four corners of frame post. (Fig. 2A)

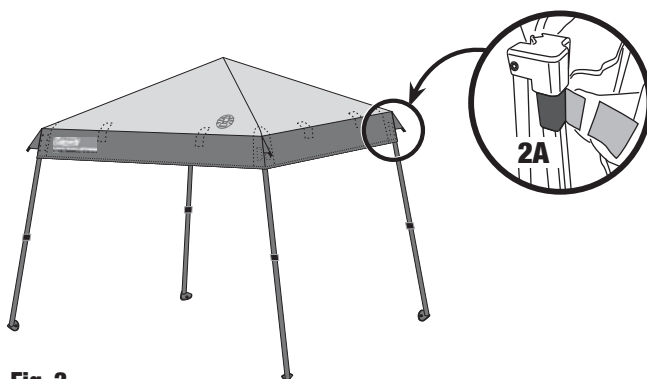

Fig. 2

- Pull up sliding bracket located on upper portion of leg until push button snaps into place. (Fig. 3) This will ensure top of frame is fully extended.

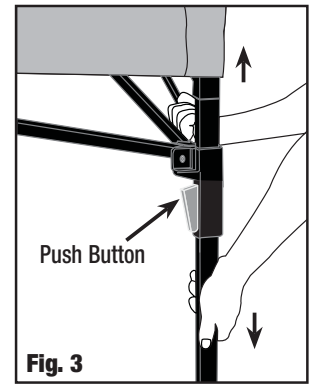

Fig. 3

- HANDY TIP:** To fully engage the push button, grip the top and bottom frame members and squeeze as shown in Fig. 3A. Be careful to avoid pinch points.

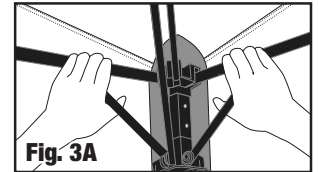

Fig. 3A

- Secure shelter top to frame with hook & loop fasteners provided. (Fig. 4 & 5)

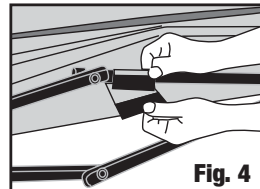

Fig. 4

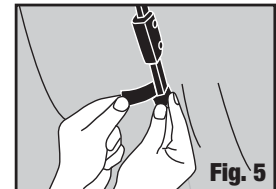

Fig. 5

## 3 Adjust the Height

- Adjust desired height until push button locks into place, making sure all four posts are level. (Fig. 6 & 7)

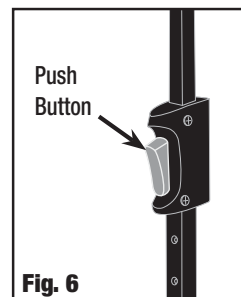

Fig. 6

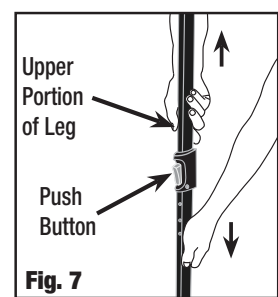

Fig. 7

## 4 Stake the Shelter

- Secure shelter by driving stakes through the holes in the base of each frame post. (Fig. 8)

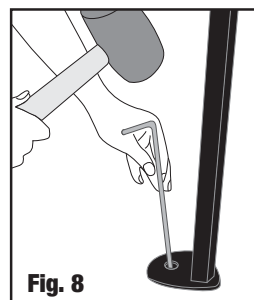

Fig. 8

(continued on other side)

# 5 Secure the Guylines

- Attach and stake out guylines. (Fig. 9 & 9A)

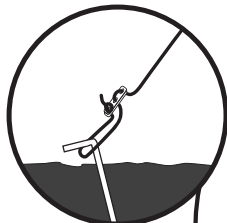

Fig. 9A

Guyline

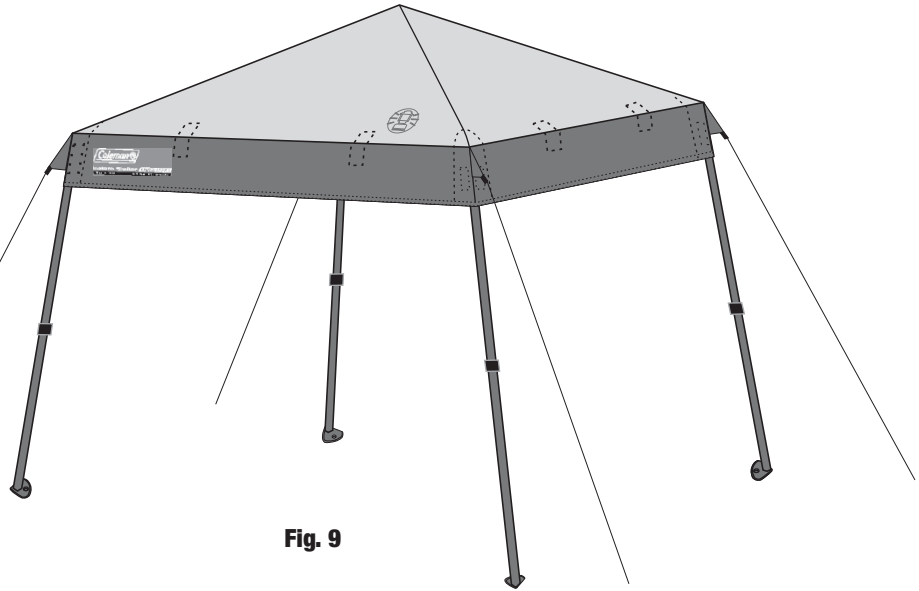

Fig. 9

# 6 Disassembly

- Remove stakes and guylines.
- Lower the frame one post at a time by pressing the push button locks located on lower portion of posts. (Fig. 10)
- Remove the upper and lower roof top from frame and fold for storage.
- Press the push buttons found at upper corners of the frame. (Fig. 11) Collapse shelter frame and store in carry bag.

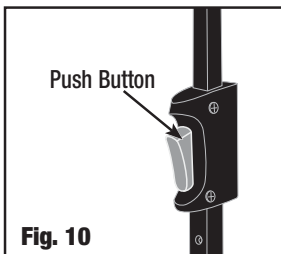

Fig. 10

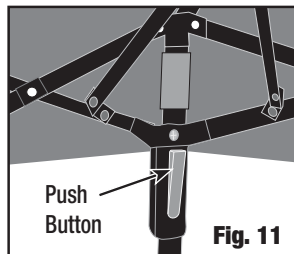

Fig. 11

# 7 To Store

1. All stakes must be placed in the storage bag to prevent damage to the fabric items placed in the carry case.
2. Make sure all components are clean and dry before placing in carry case.
3. Store in a clean, dry area.

## Things You Should Know:

- Under certain conditions (cold weather, high humidity, etc.) condensation will form on the inside of your shelter. Condensation is caused by water vapor from your breath, perspiration, or any wet clothing inside the shelter. It is NOT LEAKAGE through the shelter fabric.
- Tree limbs, tree sap, bird droppings, or moisture steadily dripping off tree limbs can cause damage to the shelter fabric and its coating resulting in leaks or loss of flame-resistant properties.
- Never store shelter, even for a short period of time, without drying it thoroughly and brushing off caked dirt. Do not pack stakes inside your shelter. Use a separate storage bag.
- Stakes should be removed by pulling on the stake itself. NEVER PULL ON THE SHELTER TO REMOVE STAKES AS THIS COULD RESULT IN PROPERTY DAMAGE OR PERSONAL INJURY.
- Do not leave your shelter set-up for weeks at a time. Be aware that exposure to ultraviolet rays from the sun can seriously damage material and/or cause it to become discolored.
- This product is not intended to be used during heavy rain, wind, hail, snow or other inclement weather. Excess water build-up can cause the frame system to become unstable, and possibly collapse, causing injury.

- The shelter top, screen, and sun wall (if included) should be carefully removed during windy conditions to avoid damage to product or personal injury.
- DO NOT use gas or flame sources under or near this product.

**⚠ WARNING: Keep all flame and heat sources away from this tent fabric.**

This tent meets the flammability requirements of CPAI-84. The fabric may burn if left in continuous contact with any flame source. The application of any foreign substance to the tent fabric may render the flame-resistant properties ineffective.



The Coleman Company, Inc. • 3600 North Hydraulic • Wichita, Kansas 67219  
1-800-835-3278 in the United States • www.coleman.com

MADE IN CHINA • PRINTED IN CHINA

© 2010 The Coleman Company, Inc. All rights reserved.  
Coleman®, Coleman®, and are registered trademarks of  
The Coleman Company, Inc.

STITCH LINE

## Free Manuals Download Website

<http://myh66.com>

<http://usermanuals.us>

<http://www.somanuals.com>

<http://www.4manuals.cc>

<http://www.manual-lib.com>

<http://www.404manual.com>

<http://www.luxmanual.com>

<http://aubethermostatmanual.com>

Golf course search by state

<http://golfingnear.com>

Email search by domain

<http://emailbydomain.com>

Auto manuals search

<http://auto.somanuals.com>

TV manuals search

<http://tv.somanuals.com>