

How To Use and Enjoy Your Coleman Lantern models 220K195 & 228K195

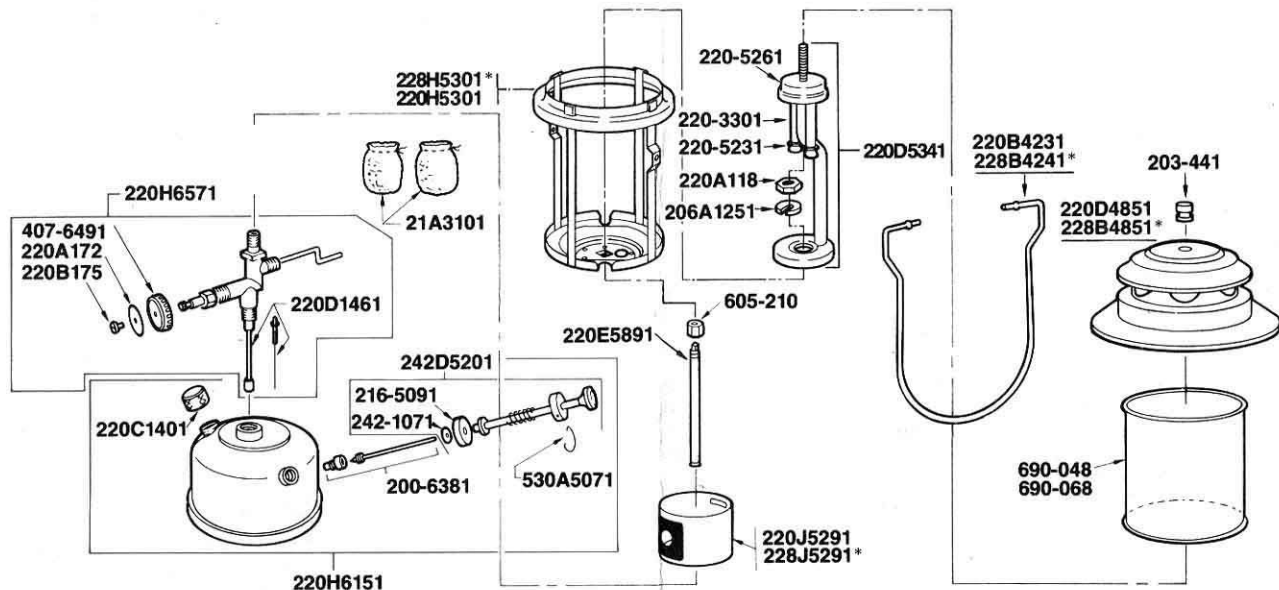
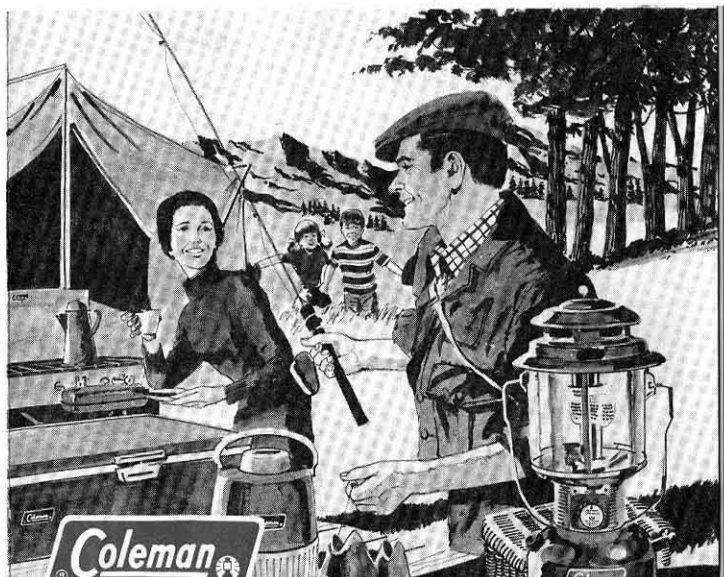

Coleman Limited 1 Year Warranty

This product is warranted to the retail consumer for one year from date of retail purchase against defects in material and workmanship and is transferable. If a Customer Information Card is enclosed please return it so that we may reach you in the unlikely event that a safety recall is needed. Return is not required to validate this warranty.

WHAT IS COVERED: Replacement parts and labor. Transportation charges to Consumer for repaired Product.

WHAT IS NOT COVERED: Transportation charges to Coleman for defective Product. Damages caused by abuse or failure to perform normal maintenance — see owner's manual. Sales outside of the United States. Any other expense. **Consequential damages, incidental damages, or incidental expenses, including damage to property. Some states do not allow the exclusion or limitation of incidental or consequential damages, so the above limitation or exclusion may not apply to you.**

HOW TO OBTAIN WARRANTY PERFORMANCE: Locate nearest Coleman Service Center by calling 1/800/835-3278 TOLL FREE! Attach to Product your name, address, description of problem, phone number and proof of date of retail purchase (sales slip). Package and return Product to Coleman Service Center, *transportation charges prepaid*.

IMPLIED WARRANTIES: Any implied warranties, including the implied warranties of merchantability and fitness for a particular purpose, are limited in duration to one year from date of retail purchase. Some states do not allow limitations on how long an implied warranty lasts, so the above limitation may not apply to you.

To the extent any provision of this warranty is prohibited by federal, state, or municipal law and cannot be preempted, it shall not be applicable. This warranty gives you specific legal rights, and you may also have other rights which vary from state to state.

THE COLEMAN COMPANY, INC. 445 N. Minnesota Wichita, Kansas 67214

Made in United States of America

THE COLEMAN COMPANY, INC.
General Office and Factory: Wichita, Kansas U.S.A. 67201
Canadian Office and Factory: Toronto, Canada

Parts List For Coleman Lantern models 220K195 & 228K195

PART NO.	DESCRIPTION	PART NO.	DESCRIPTION
8B242	Enamel, Fount Green	220D1461	Fuel & Air Tube
21A1001	Mantle	220D4851	Ventilator
200-6381	Check Valve & Stem Assy.	220E5891	Generator
203-441	Ball Nut	220J5291	Base Rest
216-5091	Pump Cup	220D5341	Burner Assy.
220A172	Direction Disc	220H6151	Fount Assy.
220-3301	Burner Tube (2)	220H6571	Valve Assy.
220-5231	Burner Cap (2)	228B4241*	Bail
220-5261	Mixing Chamber	228H5301*	Ventilator
220A118	Frame Nut	228J5291*	Frame Assy.
206A1251	U Clip Washer	242-1071	Base Rest
220B175	Screw, Valve Wheel	242D5201	Push On Nut
220B4231	Bail	407-6491	Pump Plunger Assy.
220C1401	Fuel Cap	530A5071	Valve Wheel
220C5301	Frame Assy.	605-210	Pump Cap Clip
		690-048	Jamb Nut
		690-068	Globe, Clear
			Globe, Amber
			(Accessory)

* Special for 228

Coleman Lantern Accessories



MODEL 275-764 LANTERN CARRYING CASE is tailored for these Coleman Lanterns: Model 275, Model 220, Model 228.

Protects lantern from dents, scratches, broken globes. Add to life of mantles. Eliminates annoying rattling when you travel. Case won't dent, won't rust. Positive snap-latch keeps case securely closed. Fold-down luggage-type handle is convenient compact. Case also provides room for funnel, spare generator, extra mantles.



FILTERING FUNNEL, 199B-1111, aluminum with strainer and filtering fabric. Removes water, dirt impurities from fuel. Replacement Filter 199-1091.



COLEMAN LANTERN PARTS KIT Snaps on Lantern base to hold spare parts. Comes with two mantles, wrench and tube of oil.

Other Coleman Products

COLEMAN SNOW - LITE® COOLERS. Modern living demands modern proportions. Voted exactly right by thousands of discriminating customers. Insulated with urethane foam and featuring recessed chrome-plated handles. Cam-type latch with protective shield locks with a twist of the wrist, can't be jarred open — can't be locked accidentally. The rugged Snow-Lite® Cooler has a seamless interior and rust-proof base.

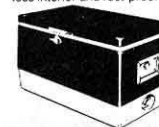

CATALYTIC HEATERS. Here's the safe way to provide comfortable heat in tents, trailers, campers, duckblinds, ice fishing huts and hundreds of other areas where heat is needed. Three different models ranging from 3,500 to 8,000 BTU's approximate input.

MODEL 413G499 CAMP STOVE. Join the fun! Select your favorite model and enjoy delicious food everywhere — and for less cost than restaurant meals. Coleman Camp Stoves fold like a suitcase, cook like a range, and cook meals for days on a tank of Coleman fuel. Available in two- or three-burner models. Also available, Coleman Camp Oven lets you bake to perfection anywhere, and Teflon Griddle for stove-top artistry.





Things You Should Know

1. Carry a spare set of Coleman Mantles.
2. Rinse tank occasionally with fresh fuel to remove sediment, gum formations, and moisture accumulations. If lantern is to be used for standby service, rinse and refill annually with fresh fuel.
3. Oil pump leather periodically to keep it soft and pliable.
4. The usual storage areas for camping and picnic equipment is the basement, attic, or garage. To avoid the accumulation of dust, cobwebs, etc. that is common in these storage areas, place your lantern in a plastic bag and seal it with a rubber band.
5. For repair service call 1-800-835-3278 TOLL FREE for location of your nearest Coleman Service Center. If lantern must be mailed to Service Center, attach your name, address, and a description of problem to product and mail to Service Center prepaid, less globe and ventilator to prevent breakage. If necessary to write the Service Center or factory, refer to your lantern as model 220K or 228K.



FUEL . . .

DIFFERENT FROM "JUST ANY FUEL"!

CLEANER . . . Quality checked for longer appliance life. Won't clog generators or wicks.

CONSISTENT . . . Tested constantly to meet Coleman's rigid quality standards.

DEPENDABLE . . . Will not sour or form gums even if stored for long periods.

CONVENIENT . . . Available nationwide in handy, easy-to-store containers.

ECONOMICAL . . . Eliminates repair costs resulting from fuel contamination.

The Generator

The generator vaporizes fuel. After extended use, deposits may build up in the generator causing the lantern to lose efficiency. Replace generator to restore efficiency.

1. Close fuel valve firmly. Remove ball nut on top of lantern and lift off ventilator and glass globe.
2. Turn cleaning lever up. Unscrew jamb nut at bottom of generator. Lift generator and unhook cleaning rod.
3. On new generator, pull cleaning rod down about 1 inch. Hold cleaning rod between thumb and forefinger with generator in upright position.
4. Slide jamb nut over top of generator.
5. Insert end of generator, into opening in air intake tube and re-hook cleaning rod. Turn cleaning lever down. Carefully lower generator to avoid bending cleaning needle.
6. Tighten jamb nut firmly to form leak tight joint. Avoid stripping threads.
7. Check mantles for damage and replace if needed. Reassemble lantern.
8. Visually check for leak immediately after lighting.

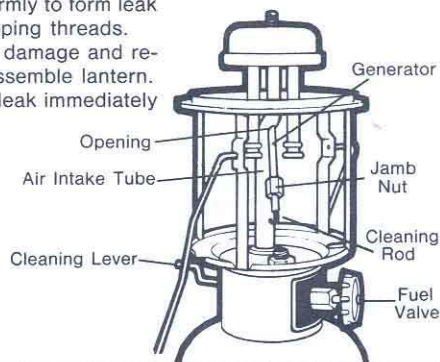

To Service Pump

1. Remove clip from pump cap.
2. Turn pump knob counter clockwise several times to unscrew air stem.
3. Pull out pump and air stem.
4. Work several drops of oil into pump leather.
5. Insert pump and air stem into tank. (Pump leather must not invert or fold.)
6. Replace pump cap and clip. Turn pump knob clockwise several times to screw air stem into tank.

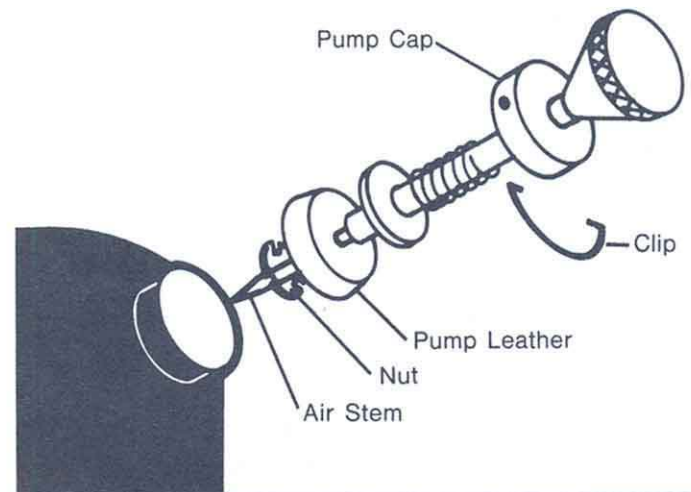

1 Follow Instructions And Warnings To Avoid Possible Injury Or Property Damage.

WARNING:

1. This lantern consumes air (oxygen). Do not use in unventilated areas. Ample ventilation must be provided. Provide additional ventilation for persons and other fuel burning appliances occupying the same enclosed area.
2. Use for lighting only. Never alter in any way or use with any device or part not expressly approved by Coleman.
3. Use only Coleman fuel or clean, fresh, white gas. Never use fuel containing lubricating oils, lead compounds, or other metallic compounds. Some unleaded automotive fuels may contain metallic compounds.
4. Fuel for your lantern is extremely flammable. Use the same care as when using gasoline.
5. Store fuel in a clean, properly marked, metal container away from flame (including pilot lights), other sources of ignition, or excessive heat.
6. Never fill lantern, loosen or remove fuel cap while lantern is lighted, near flame (including pilot lights), other ignition sources, or while top of lantern is hot to touch.
7. Never allow tents, sleeping bags, clothing, or any flammable material to come within two feet of the top and one foot of all sides of the lantern.
8. Replace any mantle with a hole in it. A hole can cause lantern to over-heat and create a hazard.
9. Never adjust light output with fuel valve or cleaning lever.
10. Keep out of reach of children.

2 To Fill

Never fill lantern, loosen or remove fuel cap while lantern is lighted, near flame (including pilot lights), other ignition sources, or while top of lantern is hot to touch.

1. Close fuel valve firmly. Turn in direction of arrow. (Fig. 1)
2. Close pump knob firmly. Turn in direction of arrow. (Fig. 2)
3. Remove fuel cap. Use a funnel or suitable filling device and fill with clean, fresh fuel. Lantern must be in a level position. DO NOT TIP. (Fig. 3)
4. Replace fuel cap on lantern and on fuel container. Tighten firmly. WIPE UP ANY SPILLED FUEL AND DISPOSE OF IN A SAFE PLACE.

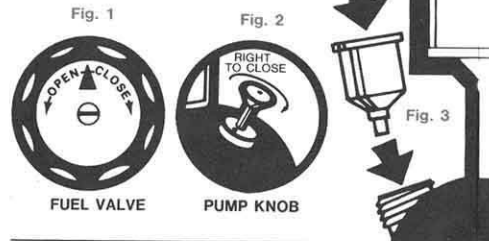

3 To Tie On Mantles

1. ALWAYS USE GENUINE COLEMAN MANTLES.

2. Tie mantles around grooves in burner caps. (Fig. 4) Flat side of mantle should face generator. Distribute folds of mantle evenly. Cut off surplus string.
3. Light bottom of mantles evenly. Burn until nothing but white ash remains.
4. Allow mantles to cool before lighting lantern.
6. Assemble lantern.

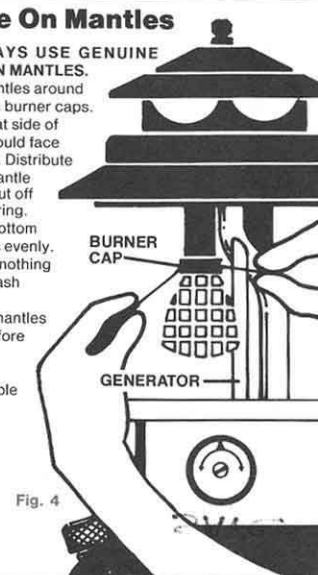

4 To Pump

1. Fuel valve and fuel cap must be closed firmly.
2. Pump Test: Close pump knob firmly. Place thumb over hole in pump knob and pump. If you feel little or no resistance, service the pump. (See back side of folder). If you feel resistance, go on to next step.
3. Open pump knob one turn.
4. With thumb over hole in pump knob, pump approximately 35 strokes. If lantern is not full of fuel, more pump strokes are required. **GOOD AIR PRESSURE IS IMPORTANT.**
5. Close pump knob firmly.

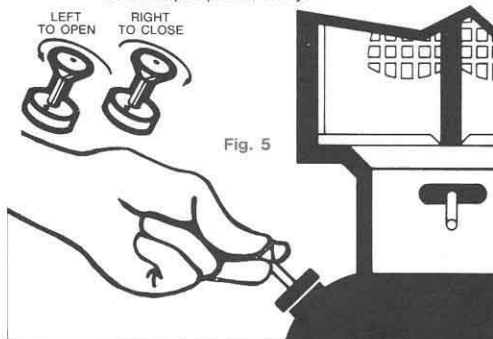

5 To Light

1. Move cleaning lever to the down position. (Fig. 6).
 2. Push lighted match through lighting hole; hold near mantle and **OPEN FUEL VALVE 1/4 TURN ONLY**. Opening further will cause flooding. Mantles will take a few seconds to light.
 3. When mantles glow brightly (no flame), open fuel valve fully.
- NOTE:** Flames other than at mantles indicate flooding or a leak. Close fuel valve firmly. Permit flames to burn out and lantern to cool. Carefully review instructions and correct problem before relighting lantern.
4. Open pump knob. Pump 15-25 strokes. Close pump knob.
 5. Rapidly rotate cleaning lever several times. Leave in down position. Repeat as necessary during operation.
 6. Additional pumping will be required at intervals. Good air pressure is important.



6 To Turn Off

1. Rapidly rotate cleaning lever several times. Leave in down position.
2. Close fuel valve firmly. Light will dim and go out in approximately one minute.



Free Manuals Download Website

<http://myh66.com>

<http://usermanuals.us>

<http://www.somanuals.com>

<http://www.4manuals.cc>

<http://www.manual-lib.com>

<http://www.404manual.com>

<http://www.luxmanual.com>

<http://aubethermostatmanual.com>

Golf course search by state

<http://golfingnear.com>

Email search by domain

<http://emailbydomain.com>

Auto manuals search

<http://auto.somanuals.com>

TV manuals search

<http://tv.somanuals.com>