

21264/EV68A Microprocessor Hardware Reference Manual

Part Number: DS-0038B-TE

This manual is directly derived from the internal 21264/EV68A Specifications, Revision 1.1. You can access this hardware reference manual in PDF format from the following site:

<ftp://ftp.compaq.com/pub/products/alphaCPUdocs>

Revision/Update Information:

Revision 1.1, March 2002

COMPAQ

**Compaq Computer Corporation
Shrewsbury, Massachusetts**

March 2002

The information in this publication is subject to change without notice.

COMPAQ COMPUTER CORPORATION SHALL NOT BE LIABLE FOR TECHNICAL OR EDITORIAL ERRORS OR OMISSIONS CONTAINED HEREIN, NOR FOR INCIDENTAL OR CONSEQUENTIAL DAMAGES RESULTING FROM THE FURNISHING, PERFORMANCE, OR USE OF THIS MATERIAL. THIS INFORMATION IS PROVIDED "AS IS" AND COMPAQ COMPUTER CORPORATION DISCLAIMS ANY WARRANTIES, EXPRESS, IMPLIED OR STATUTORY AND EXPRESSLY DISCLAIMS THE IMPLIED WARRANTIES OF MERCHANTABILITY, FITNESS FOR PARTICULAR PURPOSE, GOOD TITLE AND AGAINST INFRINGEMENT.

This publication contains information protected by copyright. No part of this publication may be photocopied or reproduced in any form without prior written consent from Compaq Computer Corporation.

© Compaq Computer Corporation 2002.

All rights reserved. Printed in the U.S.A.

COMPAQ, the Compaq logo, the Digital logo, and VAX Registered in United States Patent and Trademark Office.

Pentium is a registered trademark of Intel Corporation.

Other product names mentioned herein may be trademarks and/or registered trademarks of their respective companies.

Table of Contents

Preface

1 Introduction

1.1	The Architecture	1-1
1.1.1	Addressing	1-2
1.1.2	Integer Data Types	1-2
1.1.3	Floating-Point Data Types	1-2
1.2	21264/EV68A Microprocessor Features	1-3

2 Internal Architecture

2.1	21264/EV68A Microarchitecture	2-1
2.1.1	Instruction Fetch, Issue, and Retire Unit	2-2
2.1.1.1	Virtual Program Counter Logic	2-2
2.1.1.2	Branch Predictor	2-3
2.1.1.3	Instruction-Stream Translation Buffer	2-5
2.1.1.4	Instruction Fetch Logic	2-6
2.1.1.5	Register Rename Maps	2-6
2.1.1.6	Integer Issue Queue	2-6
2.1.1.7	Floating-Point Issue Queue	2-7
2.1.1.8	Exception and Interrupt Logic	2-8
2.1.1.9	Retire Logic	2-8
2.1.2	Integer Execution Unit	2-8
2.1.3	Floating-Point Execution Unit	2-10
2.1.4	External Cache and System Interface Unit	2-11
2.1.4.1	Victim Address File and Victim Data File	2-11
2.1.4.2	I/O Write Buffer	2-11
2.1.4.3	Probe Queue	2-11
2.1.4.4	Duplicate Dcache Tag Array	2-11
2.1.5	Onchip Caches	2-11
2.1.5.1	Instruction Cache	2-11
2.1.5.2	Data Cache	2-12
2.1.6	Memory Reference Unit	2-12
2.1.6.1	Load Queue	2-13
2.1.6.2	Store Queue	2-13
2.1.6.3	Miss Address File	2-13
2.1.6.4	Dstream Translation Buffer	2-13
2.1.7	SRAM Interface	2-13
2.2	Pipeline Organization	2-13
2.2.1	Pipeline Aborts	2-16
2.3	Instruction Issue Rules	2-16

2.3.1	Instruction Group Definitions	2-17
2.3.2	Ebox Slotting	2-18
2.3.3	Instruction Latencies	2-20
2.4	Instruction Retire Rules	2-21
2.4.1	Floating-Point Divide/Square Root Early Retire	2-22
2.5	Retire of Operate Instructions into R31/F31	2-22
2.6	Load Instructions to R31 and F31	2-23
2.6.1	Normal Prefetch: LDBU, LDF, LDG, LDL, LDT, LDWU, HW_LDL Instructions	2-23
2.6.2	Prefetch with Modify Intent: LDS Instruction	2-23
2.6.3	Prefetch, Evict Next: LDQ and HW_LDQ Instructions	2-24
2.7	Special Cases of Alpha Instruction Execution	2-24
2.7.1	Load Hit Speculation	2-24
2.7.2	Floating-Point Store Instructions	2-26
2.7.3	CMOV Instruction	2-26
2.8	Memory and I/O Address Space Instructions	2-27
2.8.1	Memory Address Space Load Instructions	2-27
2.8.2	I/O Address Space Load Instructions	2-27
2.8.3	Memory Address Space Store Instructions	2-28
2.8.4	I/O Address Space Store Instructions	2-29
2.9	MAF Memory Address Space Merging Rules	2-30
2.10	Instruction Ordering	2-30
2.11	Replay Traps	2-31
2.11.1	Mbox Order Traps	2-31
2.11.1.1	Load-Load Order Trap	2-31
2.11.1.2	Store-Load Order Trap	2-31
2.11.2	Other Mbox Replay Traps	2-32
2.12	I/O Write Buffer and the WMB Instruction	2-32
2.12.1	Memory Barrier (MB/WMB/TB Fill Flow)	2-32
2.12.1.1	MB Instruction Processing	2-33
2.12.1.2	WMB Instruction Processing	2-33
2.12.1.3	TB Fill Flow	2-34
2.13	Performance Measurement Support—Performance Counters	2-35
2.14	Floating-Point Control Register	2-35
2.15	AMASK and IMPLVER Instruction Values	2-37
2.15.1	AMASK	2-38
2.15.2	IMPLVER	2-38
2.16	Design Examples	2-38

3 Hardware Interface

3.1	21264/EV68A Microprocessor Logic Symbol	3-1
3.2	21264/EV68A Signal Names and Functions	3-3
3.3	Pin Assignments	3-8
3.4	Mechanical Specifications	3-17
3.5	21264/EV68A Packaging	3-18

4 Cache and External Interfaces

4.1	Introduction to the External Interfaces	4-1
4.1.1	System Interface	4-3
4.1.1.1	Commands and Addresses	4-4
4.1.2	Second-Level Cache (Bcache) Interface	4-4
4.2	Physical Address Considerations	4-4
4.3	Bcache Structure	4-7
4.3.1	Bcache Interface Signals	4-7
4.3.2	System Duplicate Tag Stores	4-7

4.4	Victim Data Buffer	4-8
4.5	Cache Coherency	4-8
4.5.1	Cache Coherency Basics	4-8
4.5.2	Cache Block States	4-9
4.5.3	Cache Block State Transitions	4-10
4.5.4	Using SysDc Commands	4-11
4.5.5	Dcache States and Duplicate Tags	4-13
4.6	Lock Mechanism	4-14
4.6.1	In-Order Processing of LDx_L/STx_C Instructions	4-15
4.6.2	Internal Eviction of LDx_L Blocks	4-15
4.6.3	Liveness and Fairness	4-15
4.6.4	Managing Speculative Store Issues with Multiprocessor Systems	4-16
4.7	System Port	4-16
4.7.1	System Port Pins	4-17
4.7.2	Programming the System Interface Clocks	4-18
4.7.3	21264/EV68A-to-System Commands	4-19
4.7.3.1	Bank Interleave on Cache Block Boundary Mode	4-19
4.7.3.2	Page Hit Mode	4-20
4.7.4	21264/EV68A-to-System Commands Descriptions	4-21
4.7.5	ProbeResponse Commands (Command[4:0] = 00001)	4-24
4.7.6	SysAck and 21264/EV68A-to-System Commands Flow Control	4-25
4.7.7	System-to-21264/EV68A Commands	4-26
4.7.7.1	Probe Commands (Four Cycles)	4-26
4.7.7.2	Data Transfer Commands (Two Cycles)	4-28
4.7.8	Data Movement In and Out of the 21264/EV68A	4-30
4.7.8.1	21264/EV68A Clock Basics	4-30
4.7.8.2	Fast Data Mode	4-31
4.7.8.3	Fast Data Disable Mode	4-33
4.7.8.4	SysDataInValid_L and SysDataOutValid_L	4-34
4.7.8.5	SysFillValid_L	4-35
4.7.8.6	Data Wrapping	4-36
4.7.9	Nonexistent Memory Processing	4-38
4.7.10	Ordering of System Port Transactions	4-40
4.7.10.1	21264/EV68A Commands and System Probes	4-40
4.7.10.2	System Probes and SysDc Commands	4-42
4.8	Bcache Port	4-42
4.8.1	Bcache Port Pins	4-43
4.8.2	Bcache Clocking	4-44
4.8.2.1	Setting the Period of the Cache Clock	4-45
4.8.3	Bcache Transactions	4-47
4.8.3.1	Bcache Data Read and Tag Read Transactions	4-47
4.8.3.2	Bcache Data Write Transactions	4-48
4.8.3.3	Bubbles on the Bcache Data Bus	4-49
4.8.4	Pin Descriptions	4-50
4.8.4.1	BcAdd_H[23:4]	4-51
4.8.4.2	Bcache Control Pins	4-51
4.8.4.3	BcDataInCik_H and BcTagInCik_H	4-53
4.8.5	Bcache Banking	4-53
4.8.6	Disabling the Bcache for Debugging	4-53
4.9	Interrupts	4-54

5 Internal Processor Registers

5.1	Ebox IPRs	5-3
5.1.1	Cycle Counter Register – CC	5-3
5.1.2	Cycle Counter Control Register – CC_CTL	5-3
5.1.3	Virtual Address Register – VA	5-4

5.1.4	Virtual Address Control Register – VA_CTL	5–4
5.1.5	Virtual Address Format Register – VA_FORM	5–5
5.2	Ibox IPRs	5–6
5.2.1	ITB Tag Array Write Register – ITB_TAG	5–6
5.2.2	ITB PTE Array Write Register – ITB_PTE	5–6
5.2.3	ITB Invalidate All Process (ASM=0) Register – ITB_IAP	5–7
5.2.4	ITB Invalidate All Register – ITB_IA	5–7
5.2.5	ITB Invalidate Single Register – ITB_IS	5–7
5.2.6	ProfileMe PC Register – PMPC	5–8
5.2.7	Exception Address Register – EXC_ADDR	5–8
5.2.8	Instruction Virtual Address Format Register – IVA_FORM	5–9
5.2.9	Interrupt Enable and Current Processor Mode Register – IER_CM	5–9
5.2.10	Software Interrupt Request Register – SIRR	5–10
5.2.11	Interrupt Summary Register – ISUM	5–11
5.2.12	Hardware Interrupt Clear Register – HW_INT_CLR	5–12
5.2.13	Exception Summary Register – EXC_SUM	5–13
5.2.14	PAL Base Register – PAL_BASE	5–15
5.2.15	Ibox Control Register – I_CTL	5–15
5.2.16	Ibox Status Register – I_STAT	5–18
5.2.17	Icache Flush Register – IC_FLUSH	5–21
5.2.18	Icache Flush ASM Register – IC_FLUSH_ASM	5–21
5.2.19	Clear Virtual-to-Physical Map Register – CLR_MAP	5–21
5.2.20	Sleep Mode Register – SLEEP	5–21
5.2.21	Process Context Register – PCTX	5–21
5.2.22	Performance Counter Control Register – PCTR_CTL	5–23
5.3	Mbox IPRs	5–25
5.3.1	DTB Tag Array Write Registers 0 and 1 – DTB_TAG0, DTB_TAG1	5–25
5.3.2	DTB PTE Array Write Registers 0 and 1 – DTB_PTE0, DTB_PTE1	5–26
5.3.3	DTB Alternate Processor Mode Register – DTB_ALTMODE	5–26
5.3.4	Dstream TB Invalidate All Process (ASM=0) Register – DTB_IAP	5–27
5.3.5	Dstream TB Invalidate All Register – DTB_IA	5–27
5.3.6	Dstream TB Invalidate Single Registers 0 and 1 – DTB_IS0,1	5–27
5.3.7	Dstream TB Address Space Number Registers 0 and 1 – DTB_ASN0,1	5–28
5.3.8	Memory Management Status Register – MM_STAT	5–28
5.3.9	Mbox Control Register – M_CTL	5–29
5.3.10	Dcache Control Register – DC_CTL	5–30
5.3.11	Dcache Status Register – DC_STAT	5–31
5.4	Cbox CSRs and IPRs	5–32
5.4.1	Cbox Data Register – C_DATA	5–33
5.4.2	Cbox Shift Register – C_SHFT	5–33
5.4.3	Cbox WRITE_ONCE Chain Description	5–33
5.4.4	Cbox WRITE_MANY Chain Description	5–38
5.4.5	Cbox Read Register (IPR) Description	5–41

6 Privileged Architecture Library Code

6.1	PALcode Description	6–1
6.2	PALmode Environment	6–2
6.3	Required PALcode Function Codes	6–3
6.4	Opcodes Reserved for PALcode	6–3
6.4.1	HW_LD Instruction	6–3
6.4.2	HW_ST Instruction	6–4
6.4.3	HW_RET Instruction	6–5
6.4.4	HW_MFPR and HW_MTPR Instructions	6–6
6.5	Internal Processor Register Access Mechanisms	6–7
6.5.1	IPR Scoreboard Bits	6–8
6.5.2	Hardware Structure of Explicitly Written IPRs	6–8

6.5.3	Hardware Structure of Implicitly Written IPRs	6-9
6.5.4	IPR Access Ordering	6-9
6.5.5	Correct Ordering of Explicit Writers Followed by Implicit Readers	6-10
6.5.6	Correct Ordering of Explicit Readers Followed by Implicit Writers	6-11
6.6	PALshadow Registers	6-11
6.7	PALcode Emulation of the FPCR	6-11
6.7.1	Status Flags	6-12
6.7.2	MF_FPCR	6-12
6.7.3	MT_FPCR	6-12
6.8	PALcode Entry Points	6-12
6.8.1	CALL_PAL Entry Points	6-12
6.8.2	PALcode Exception Entry Points	6-13
6.9	Translation Buffer (TB) Fill Flows	6-14
6.9.1	DTB Fill	6-14
6.9.2	ITB Fill	6-16
6.10	Performance Counter Support	6-17
6.10.1	General Precautions	6-18
6.10.2	Aggregate Mode Programming Guidelines	6-18
6.10.2.1	Aggregate Mode Precautions	6-18
6.10.2.2	Operation	6-19
6.10.2.3	Aggregate Counting Mode Description	6-20
6.10.2.3.1	Cycle counting	6-20
6.10.2.3.2	Retired instructions cycles	6-20
6.10.2.3.3	Bcache miss or long latency probes cycles	6-20
6.10.2.3.4	Mbox replay traps cycles	6-20
6.10.2.4	Counter Modes for Aggregate Mode	6-20
6.10.3	ProfileMe Mode Programming Guidelines	6-20
6.10.3.1	ProfileMe Mode Precautions	6-20
6.10.3.2	Operation	6-21
6.10.3.3	ProfileMe Counting Mode Description	6-23
6.10.3.3.1	Cycle counting	6-23
6.10.3.3.2	Inum retire delay cycles	6-23
6.10.3.3.3	Retired instructions cycles	6-23
6.10.3.3.4	Bcache miss or long latency probes cycles	6-23
6.10.3.3.5	Mbox replay traps cycles	6-23
6.10.3.4	Counter Modes for ProfileMe Mode	6-24

7 Initialization and Configuration

7.1	Power-Up Reset Flow and the Reset_L and DCOK_H Pins	7-1
7.1.1	Power Sequencing and Reset State for Signal Pins	7-3
7.1.2	Clock Forwarding and System Clock Ratio Configuration	7-4
7.1.3	PLL Ramp Up	7-6
7.1.4	BiST and SROM Load and the TestStat_H Pin	7-6
7.1.5	Clock Forward Reset and System Interface Initialization	7-7
7.2	Fault Reset Flow	7-8
7.3	Energy Star Certification and Sleep Mode Flow	7-9
7.4	Warm Reset Flow	7-11
7.5	Array Initialization	7-12
7.6	Initialization Mode Processing	7-12
7.7	External Interface Initialization	7-14
7.8	Internal Processor Register Power-Up Reset State	7-14
7.9	IEEE 1149.1 Test Port Reset	7-16
7.10	Reset State Machine	7-16
7.11	Phase-Lock Loop (PLL) Functional Description	7-19
7.11.1	Differential Reference Clocks	7-19
7.11.2	PLL Output Clocks	7-19

7.11.2.1	GCLK	7-19
7.11.2.2	Differential 21264/EV68A Clocks	7-19
7.11.2.3	Nominal Operating Frequency	7-19
7.11.2.4	Power-Up/Reset Clocking	7-20

8 Error Detection and Error Handling

8.1	Data Error Correction Code	8-2
8.2	Icache Data or Tag Parity Error	8-2
8.3	Dcache Tag Parity Error	8-2
8.4	Dcache Data Single-Bit Correctable ECC Error	8-3
8.4.1	Load Instruction	8-3
8.4.2	Store Instruction (Quadword or Smaller)	8-4
8.4.3	Dcache Victim Extracts	8-4
8.5	Dcache Store Second Error	8-4
8.6	Dcache Duplicate Tag Parity Error	8-4
8.7	Bcache Tag Parity Error	8-5
8.8	Controlling Bcache Block Parity Calculation	8-5
8.9	Bcache Data Single-Bit Correctable ECC Error	8-5
8.9.1	Icache Fill from Bcache	8-5
8.9.2	Dcache Fill from Bcache	8-6
8.9.3	Bcache Victim Read	8-7
8.9.3.1	Bcache Victim Read During a Dcache/Bcache Miss	8-7
8.9.3.2	Bcache Victim Read During an ECB Instruction	8-7
8.10	Memory/System Port Single-Bit Data Correctable ECC Error	8-7
8.10.1	Icache Fill from Memory	8-7
8.10.2	Dcache Fill from Memory	8-8
8.11	Bcache Data Single-Bit Correctable ECC Error on a Probe	8-9
8.12	Double-Bit Fill Errors	8-9
8.13	Error Case Summary	8-10

9 Electrical Data

9.1	Electrical Characteristics	9-1
9.2	DC Characteristics	9-2
9.3	Power Supply Sequencing and Avoiding Potential Failure Mechanisms	9-5
9.4	AC Characteristics	9-6

10 Thermal Management

10.1	Operating Temperature	10-1
10.2	Heat Sink Specifications	10-3
10.3	Thermal Design Considerations	10-6

11 Testability and Diagnostics

11.1	Test Pins	11-1
11.2	SROM/Serial Diagnostic Terminal Port	11-2
11.2.1	SROM Load Operation	11-2
11.2.2	Serial Terminal Port	11-2
11.3	IEEE 1149.1 Port	11-3
11.4	TestStat_H Pin	11-4
11.5	Power-Up Self-Test and Initialization	11-5
11.5.1	Built-in Self-Test	11-5

11.5.2	SROM Initialization	11-5
11.5.2.1	Serial Instruction Cache Load Operation	11-6
11.6	Notes on IEEE 1149.1 Operation and Compliance	11-7

A Alpha Instruction Set

A.1	Alpha Instruction Summary	A-1
A.2	Reserved Opcodes	A-8
A.2.1	Opcodes Reserved for Compaq	A-8
A.2.2	Opcodes Reserved for PALcode	A-9
A.3	IEEE Floating-Point Instructions	A-9
A.4	VAX Floating-Point Instructions	A-11
A.5	Independent Floating-Point Instructions	A-11
A.6	Opcode Summary	A-12
A.7	Required PALcode Function Codes	A-13
A.8	IEEE Floating-Point Conformance	A-14

B 21264/EV68A Boundary-Scan Register

B.1	Boundary-Scan Register	B-1
B.1.1	BSDL Description of the Alpha 21264/EV68A Boundary-Scan Register	B-1

C Serial Icache Load Predecode Values

D PALcode Restrictions and Guidelines

D.1	Restriction 1 : Reset Sequence Required by Retire Logic and Mapper	D-1
D.2	Restriction 2 : No Multiple Writers to IPRs in Same Scoreboard Group	D-8
D.3	Restriction 4 : No Writers and Readers to IPRs in Same Scoreboard Group	D-8
D.4	Guideline 6 : Avoid Consecutive Read-Modify-Write-Read-Modify-Write	D-9
D.5	Restriction 7 : Replay Trap, Interrupt Code Sequence, and STF/ITOF	D-9
D.6	Restriction 9 : PALmode Istream Address Ranges	D-10
D.7	Restriction 10: Duplicate IPR Mode Bits	D-10
D.8	Restriction 11: Ibox IPR Update Synchronization	D-11
D.9	Restriction 12: MFPR of Implicitly-Written IPRs EXC_ADDR, IVA_FORM, and EXC_SUM	D-11
D.10	Restriction 13 : DTB Fill Flow Collision	D-11
D.11	Restriction 14 : HW_RET	D-11
D.12	Guideline 16 : JSR-BAD VA	D-12
D.13	Restriction 17: MTPR to DTB_TAG0/DTB_PTE0/DTB_TAG1/DTB_PTE1	D-12
D.14	Restriction 18: No FP Operates, FP Conditional Branches, FTOI, or STF in Same Fetch Block as HW_MTPR	D-12
D.15	Restriction 19: HW_RET/STALL After Updating the FPCR by way of MT_FPCR in PALmode	D-12
D.16	Guideline 20 : I_CTL[SBE] Stream Buffer Enable	D-12
D.17	Restriction 21: HW_RET/STALL After HW_MTPR ASN0/ASN1	D-12
D.18	Restriction 22: HW_RET/STALL After HW_MTPR ISO/IS1	D-13
D.19	Restriction 23: HW_ST/P/CONDITIONAL Does Not Clear the Lock Flag	D-13
D.20	Restriction 24: HW_RET/STALL After HW_MTPR IC_FLUSH, IC_FLUSH_ASM, CLEAR_MAP	D-14
D.21	Restriction 25: HW_MTPR ITB_IA After Reset	D-14
D.22	Guideline 26: Conditional Branches in PALcode	D-14
D.23	Restriction 27: Reset of 'Force-Fail Lock Flag' State in PALcode	D-15
D.24	Restriction 28: Enforce Ordering Between IPRs Implicitly Written by Loads and Subsequent Loads	D-15
D.25	Guideline 29 : JSR, JMP, RET, and JSR_COR in PALcode	D-15

D.26	Restriction 30 : HW_MTPR and HW_MFPR to the Cbox CSR	D-15
D.27	Restriction 31 : I_CTL[VA_48] Update	D-17
D.28	Restriction 32 : PCTR_CTL Update	D-17
D.29	Restriction 33 : HW_LD Physical/Lock Use.	D-18
D.30	Restriction 34 : Writing Multiple ITB Entries in the Same PALcode Flow	D-18
D.31	Guideline 35 : HW_INT_CLR Update	D-18
D.32	Restriction 36 : Updating I_CTL[SDE].	D-18
D.33	Restriction 37 : Updating VA_CTL[VA_48]	D-18
D.34	Restriction 38 : Updating PCTR_CTL	D-18
D.35	Guideline 39: Writing Multiple DTB Entries in the Same PAL Flow.	D-19
D.36	Restriction 40: Scrubbing a Single-Bit Error	D-19
D.37	Restriction 41: MTPR ITB_TAG, MTPR ITB_PTE Must be in the Same Fetch Block	D-21
D.38	Restriction 42: Updating VA_CTL, CC_CTL, or CC IPRs	D-21
D.39	Restriction 43: No Trappable Instructions Along with HW_MTPR.	D-21
D.40	Restriction 44: Not Applicable to the 21264/EV68A	D-21
D.41	Restriction 45: No HW_JMP or JMP Instructions in PALcode	D-21
D.42	Restriction 46: Avoiding Livelocks in Speculative Load CRD Handlers	D-22
D.43	Restriction 47: Cache Eviction for Single-Bit Cache Errors	D-22
D.44	Restriction 48: MB Bracketing of Dcache Writes to Force Bad Data ECC and Force Bad Tag Parity	D-24

E 21264/EV68A-to-Bcache Pin Interface

E.1	Forwarding Clock Pin Groupings.	E-1
E.2	Late-Write Non-Bursting SSRAMs	E-2
E.3	Dual-Data Rate SSRAMs	E-3

Glossary

Index

Figures

2-1	21264/EV68A Block Diagram	2-3
2-2	Branch Predictor	2-4
2-3	Local Predictor	2-4
2-4	Global Predictor.	2-5
2-5	Choice Predictor	2-5
2-6	Integer Execution Unit—Clusters 0 and 1	2-9
2-7	Floating-Point Execution Units	2-10
2-8	Pipeline Organization	2-14
2-9	Pipeline Timing for Integer Load Instructions	2-24
2-10	Pipeline Timing for Floating-Point Load Instructions	2-25
2-11	Floating-Point Control Register	2-36
2-12	Typical Uniprocessor Configuration	2-39
2-13	Typical Multiprocessor Configuration	2-39
3-1	21264/EV68A Microprocessor Logic Symbol	3-2
3-2	Package Dimensions.	3-17
3-3	21264/EV68A Top View (Pin Down)	3-18
3-4	21264/EV68A Bottom View (Pin Up).	3-19
4-1	21264/EV68A System and Bcache Interfaces	4-3
4-2	21264/EV68A Bcache Interface Signals	4-7
4-3	Cache Subset Hierarchy	4-9
4-4	System Interface Signals.	4-17
4-5	Fast Transfer Timing Example	4-32
4-6	SysFillValid_L Timing	4-36
5-1	Cycle Counter Register	5-3
5-2	Cycle Counter Control Register.	5-3
5-3	Virtual Address Register	5-4
5-4	Virtual Address Control Register.	5-4
5-5	Virtual Address Format Register (VA_48 = 0, VA_FORM_32 = 0)	5-5
5-6	Virtual Address Format Register (VA_48 = 1, VA_FORM_32 = 0)	5-6
5-7	Virtual Address Format Register (VA_48 = 0, VA_FORM_32 = 1)	5-6
5-8	ITB Tag Array Write Register	5-6
5-9	ITB PTE Array Write Register	5-7
5-10	ITB Invalidate Single Register.	5-7
5-11	ProfileMe PC Register.	5-8
5-12	Exception Address Register	5-8
5-13	Instruction Virtual Address Format Register (VA_48 = 0, VA_FORM_32 = 0)	5-9
5-14	Instruction Virtual Address Format Register (VA_48 = 1, VA_FORM_32 = 0)	5-9
5-15	Instruction Virtual Address Format Register (VA_48 = 0, VA_FORM_32 = 1)	5-9
5-16	Interrupt Enable and Current Processor Mode Register.	5-10
5-17	Software Interrupt Request Register.	5-11
5-18	Interrupt Summary Register	5-11
5-19	Hardware Interrupt Clear Register	5-12
5-20	Exception Summary Register	5-14
5-21	PAL Base Register	5-15
5-22	Ibox Control Register.	5-16
5-23	Ibox Status Register	5-19
5-24	Process Context Register	5-22
5-25	Performance Counter Control Register.	5-23
5-26	DTB Tag Array Write Registers 0 and 1	5-25
5-27	DTB PTE Array Write Registers 0 and 1.	5-26
5-28	DTB Alternate Processor Mode Register	5-26
5-29	Dstream Translation Buffer Invalidate Single Registers	5-27
5-30	Dstream Translation Buffer Address Space Number Registers 0 and 1	5-28
5-31	Memory Management Status Register	5-28
5-32	Mbox Control Register.	5-29
5-33	Dcache Control Register	5-31

5-34	Dcache Status Register	5-32
5-35	Cbox Data Register	5-33
5-36	Cbox Shift Register	5-33
5-37	WRITE_MANY Chain Write Transaction Example	5-39
6-1	HW_LD Instruction Format	6-4
6-2	HW_ST Instruction Format	6-4
6-3	HW_RET Instruction Format	6-6
6-4	HW_MFPR and HW_MTPR Instructions Format	6-6
6-5	Single-Miss DTB Instructions Flow Example.	6-14
6-6	ITB Miss Instructions Flow Example	6-16
7-1	Power-Up Timing Sequence	7-3
7-2	Fault Reset Sequence of Operation	7-9
7-3	Sleep Mode Sequence of Operation	7-11
7-4	Example for Initializing Bcache	7-13
7-5	21264/EV68A Reset State Machine State Diagram	7-17
10-1	Type 1 Heat Sink	10-3
10-2	Type 2 Heat Sink	10-4
10-3	Type 3 Heat Sink	10-5
11-1	TestStat_H Pin Timing During Power-Up Built-In Self-Test (BiST)	11-5
11-2	TestStat_H Pin Timing During Built-In Self-Initialization (BiSI)	11-5
11-3	SRROM Content Map	11-6

Tables

1-1	Integer Data Types	1-2
2-1	Pipeline Abort Delay (GCLK Cycles).	2-16
2-2	Instruction Name, Pipeline, and Types	2-17
2-3	Instruction Group Definitions and Pipeline Unit.	2-18
2-4	Instruction Class Latency in Cycles.	2-20
2-5	Minimum Retire Latencies for Instruction Classes	2-21
2-6	Instructions Retired Without Execution	2-23
2-7	Rules for I/O Address Space Load Instruction Data Merging	2-28
2-8	Rules for I/O Address Space Store Instruction Data Merging	2-29
2-9	MAF Merging Rules.	2-30
2-10	Memory Reference Ordering.	2-30
2-11	I/O Reference Ordering.	2-31
2-12	TB Fill Flow Example Sequence 1	2-34
2-13	TB Fill Flow Example Sequence 2	2-34
2-14	Floating-Point Control Register Fields.	2-36
2-15	21264/EV68A AMASK Values.	2-38
2-16	AMASK Bit Assignments	2-38
3-1	Signal Pin Types Definitions	3-3
3-2	21264/EV68A Signal Descriptions	3-3
3-3	21264/EV68A Signal Descriptions by Function.	3-6
3-4	Pin List Sorted by Signal Name.	3-8
3-5	Pin List Sorted by PGA Location	3-12
3-6	Ground and Power (VSS and VDD) Pin List	3-16
4-1	Translation of Internal References to External Interface Reference	4-5
4-2	21264/EV68A-Supported Cache Block States	4-9
4-3	Cache Block State Transitions	4-10
4-4	System Responses to 21264/EV68A Commands.	4-10
4-5	System Responses to 21264/EV68A Commands and Reactions.	4-11
4-6	System Port Pins.	4-17
4-7	Programming Values for System Interface Clocks	4-18
4-8	Program Values for Data-Sample/Drive CSRs	4-18
4-9	Forwarded Clocks and Frame Clock Ratio	4-19
4-10	Bank Interleave on Cache Block Boundary Mode of Operation	4-19
4-11	Page Hit Mode of Operation	4-20
4-12	21264/EV68A-to-System Command Fields Definitions	4-20
4-13	Maximum Physical Address for Short Bus Format	4-21
4-14	21264/EV68A-to-System Commands Descriptions.	4-21
4-15	Programming <code>INVAL_TO_DIRTY_ENABLE[1:0]</code>	4-23
4-16	Programming <code>SET_DIRTY_ENABLE[2:0]</code>	4-24
4-17	21264/EV68A ProbeResponse Command	4-24
4-18	ProbeResponse Fields Descriptions	4-25
4-19	System-to-21264/EV68A Probe Commands.	4-26
4-20	System-to-21264/EV68A Probe Commands Fields Descriptions	4-27
4-21	Data Movement Selection by Probe[4:3].	4-27
4-22	Next Cache Block State Selection by Probe[2:0]	4-27
4-23	Data Transfer Command Format	4-28
4-24	<code>SysDc[4:0]</code> Field Description	4-29
4-25	<code>SYSClk</code> Cycles Between <code>SysAddOut</code> and <code>SysData</code>	4-32
4-26	<code>Cbox CSR SYSDC_DELAY[4:0]</code> Examples	4-33
4-27	Four Timing Examples	4-34
4-28	Data Wrapping Rules	4-36
4-29	System Wrap and Deliver Data	4-37
4-30	Wrap Interleave Order.	4-37
4-31	Wrap Order for Double-Pumped Data Transfers.	4-38
4-32	21264/EV68A Commands with <code>NXM</code> Addresses and System Response	4-39
4-33	21264/EV68A Response to System Probe and In-Flight Command Interaction	4-41

4-34	Rules for System Control of Cache Status Update Order	4-42
4-35	Range of Maximum Bcache Clock Ratios	4-43
4-36	Bcache Port Pins	4-43
4-37	BC_CPU_CLK_DELAY[1:0] Values	4-45
4-38	BC_CLK_DELAY[1:0] Values	4-45
4-39	Program Values to Set the Cache Clock Period (Single-Data)	4-46
4-40	Program Values to Set the Cache Clock Period (Dual-Data Rate)	4-46
4-41	Data-Sample/Drive Cbox CSRs	4-47
4-42	Programming the Bcache to Support Each Size of the Bcache	4-51
4-43	Programming the Bcache Control Pins	4-51
4-44	Control Pin Assertion for RAM_TYPE A	4-51
4-45	Control Pin Assertion for RAM_TYPE B	4-52
4-46	Control Pin Assertion for RAM_TYPE C	4-52
4-47	Control Pin Assertion for RAM_TYPE D	4-52
5-1	Internal Processor Registers	5-1
5-2	Cycle Counter Control Register Fields Description	5-4
5-3	Virtual Address Control Register Fields Description	5-5
5-4	ProfileMe PC Fields Description	5-8
5-5	IER_CM Register Fields Description	5-10
5-6	Software Interrupt Request Register Fields Description	5-11
5-7	Interrupt Summary Register Fields Description	5-12
5-8	Hardware Interrupt Clear Register Fields Description	5-13
5-9	Exception Summary Register Fields Description	5-14
5-10	PAL Base Register Fields Description	5-15
5-11	Ibox Control Register Fields Description	5-16
5-12	Ibox Status Register Fields Description	5-19
5-13	IPR Index Bits and Register Fields	5-21
5-14	Process Context Register Fields Description	5-22
5-15	Performance Counter Control Register Fields Description	5-23
5-16	Performance Counter Control Register Input Select Fields	5-25
5-17	DTB Alternate Processor Mode Register Fields Description	5-26
5-18	Memory Management Status Register Fields Description	5-28
5-19	Mbox Control Register Fields Description	5-30
5-20	Dcache Control Register Fields Description	5-31
5-21	Dcache Status Register Fields Description	5-32
5-22	Cbox Data Register Fields Description	5-33
5-23	Cbox Shift Register Fields Description	5-33
5-24	Cbox WRITE_ONCE Chain Order	5-34
5-25	Cbox WRITE_MANY Chain Order	5-39
5-26	Cbox Read IPR Fields Description	5-41
6-1	Required PALcode Function Codes	6-3
6-2	Opcodes Reserved for PALcode	6-3
6-3	HW_LD Instruction Fields Descriptions	6-4
6-4	HW_ST Instruction Fields Descriptions	6-5
6-5	HW_RET Instruction Fields Descriptions	6-6
6-6	HW_MFPR and HW_MTPR Instructions Fields Descriptions	6-7
6-7	Paired Instruction Fetch Order	6-9
6-8	PALcode Exception Entry Locations	6-13
6-9	IPRs Used for Performance Counter Support	6-18
6-10	Aggregate Mode Returned IPR Contents	6-19
6-11	Aggregate Mode Performance Counter IPR Input Select Fields	6-20
6-12	CMOV Decomposed	6-21
6-13	ProfileMe Mode Returned IPR Contents	6-22
6-14	ProfileMe Mode PCTR_CTL Input Select Fields	6-24
7-1	21264/EV68A Reset State Machine Major Operations	7-1
7-2	Signal Pin Reset State	7-3
7-3	Pin Signal Names and Initialization State	7-5
7-4	Power-Up Flow Signals and Their Constraints	7-7
7-5	Effect on IPRs After Fault Reset	7-8

7-6	Effect on IPRs After Transition Through Sleep Mode	7-10
7-7	Signals and Constraints for the Sleep Mode Sequence	7-11
7-8	Effect on IPRs After Warm Reset	7-11
7-9	WRITE_MANY Chain CSR Values for Bcache Initialization	7-12
7-10	Internal Processor Registers at Power-Up Reset State	7-14
7-11	21264/EV68A Reset State Machine State Descriptions	7-17
7-12	Differential Reference Clock Frequencies in Full-Speed Lock	7-20
8-1	21264/EV68A Error Detection Mechanisms	8-1
8-2	64-Bit Data and Check Bit ECC Code	8-2
8-3	Error Case Summary	8-10
9-1	Maximum Electrical Ratings	9-1
9-2	Signal Types	9-2
9-3	VDD (I_DC_POWER)	9-3
9-4	Input DC Reference Pin (I_DC_REF)	9-3
9-5	Input Differential Amplifier Receiver (I_DA)	9-3
9-6	Input Differential Amplifier Clock Receiver (I_DA_CLK)	9-3
9-7	Pin Type: Open-Drain Output Driver (O_OD)	9-4
9-8	Bidirectional, Differential Amplifier Receiver, Open-Drain Output Driver (B_DA_OD)	9-4
9-9	Pin Type: Open-Drain Driver for Test Pins (O_OD_TP)	9-4
9-10	Bidirectional, Differential Amplifier Receiver, Push-Pull Output Driver (B_DA_PP)	9-4
9-11	Push-Pull Output Driver (O_PP)	9-5
9-12	Push-Pull Output Clock Driver (O_PP_CLK)	9-5
9-13	AC Specifications	9-7
10-1	Operating Temperature at Heat Sink Center (Tc)	10-1
10-2	qca at Various Airflows for 21264/EV68A	10-2
10-3	Maximum Ta for 21264/EV68A @ 750 MHz and @ 1.7 V with Various Airflows	10-2
10-4	Maximum Ta for 21264/EV68A @ 833 MHz and @ 1.7 V with Various Airflows	10-2
10-5	Maximum Ta for 21264/EV68A @ 875 MHz and @ 1.7 V with Various Airflows	10-2
10-6	Maximum Ta for 21264/EV68A @ 940 MHz and @ 1.7 V with Various Airflows	10-2
11-1	Dedicated Test Port Pins	11-1
11-2	IEEE 1149.1 Instructions and Opcodes	11-3
11-3	TAP Controller State Machine	11-4
11-4	Icache Bit Fields in an SRAM Line	11-7
A-1	Instruction Format and Opcode Notation	A-1
A-2	Architecture Instructions	A-2
A-3	Opcodes Reserved for Compaq	A-8
A-4	Opcodes Reserved for PALcode	A-9
A-5	IEEE Floating-Point Instruction Function Codes	A-9
A-6	VAX Floating-Point Instruction Function Codes	A-11
A-7	Independent Floating-Point Instruction Function Codes	A-12
A-8	Opcode Summary	A-12
A-9	Key to Opcode Summary Used in Table A-8	A-13
A-10	Required PALcode Function Codes	A-13
A-11	Exceptional Input and Output Conditions	A-15
E-1	Bcache Forwarding Clock Pin Groupings	E-1
E-2	Late-Write Non-Bursting SSRAMs Data Pin Usage	E-2
E-3	Late-Write Non-Bursting SSRAMs Tag Pin Usage	E-2
E-4	Dual-Data Rate SSRAM Data Pin Usage	E-3
E-5	Dual-Data Rate SSRAM Tag Pin Usage	E-4

Preface

Audience

This manual is for system designers and programmers who use the Alpha 21264/EV68A microprocessor (referred to as the 21264/EV68A).

Content

This manual contains the following chapters and appendixes:

Chapter 1, Introduction, introduces the 21264/EV68A and provides an overview of the Alpha architecture.

Chapter 2, Internal Architecture, describes the major hardware functions and the internal chip architecture. It describes performance measurement facilities, coding rules, and design examples.

Chapter 3, Hardware Interface, lists and describes the internal hardware interface signals, and provides mechanical data and packaging information, including signal pin lists.

Chapter 4, Cache and External Interfaces, describes the external bus functions and transactions, lists bus commands, and describes the clock functions.

Chapter 5, Internal Processor Registers, lists and describes the internal processor register set.

Chapter 6, Privileged Architecture Library Code, describes the privileged architecture library code (PALcode).

Chapter 7, Initialization and Configuration, describes the initialization and configuration sequence.

Chapter 8, Error Detection and Error Handling, describes error detection and error handling.

Chapter 9, Electrical Data, provides electrical data and describes signal integrity issues.

Chapter 10, Thermal Management, provides information about thermal management.

Chapter 11, Testability and Diagnostics, describes chip and system testability features.

Appendix A, Alpha Instruction Set, summarizes the Alpha instruction set.

Appendix B, 21264/EV68A Boundary-Scan Register, presents the BSDL description of the 21264/EV68A boundary-scan register.

Appendix C, Serial Icache Load Predecode Values, provides a pointer to the Alpha Motherboards Software Developer's Kit (SDK), which contains this information.

Appendix D, PALcode Restrictions and Guidelines, lists restrictions and guidelines that must be adhered to when generating PALcode.

Appendix E, 21264/EV68A-to-Bcache Pin Interface, provides the pin interface between the 21264/EV68A and Bcache SSRAMs.

The Glossary lists and defines terms associated with the 21264/EV68A.

An Index is provided at the end of the document.

Documentation Included by Reference

The companion volume to this manual, the *Alpha Architecture Reference Manual, Fourth Edition*, can be accessed from the following website: <ftp.compaq.com/pub/products/alphaCPUdocs>.

Terminology and Conventions

This section defines the abbreviations, terminology, and other conventions used throughout this document.

Abbreviations

- Binary Multiples

The abbreviations K, M, and G (kilo, mega, and giga) represent binary multiples and have the following values.

$$K = 2^{10} (1024)$$

$$M = 2^{20} (1,048,576)$$

$$G = 2^{30} (1,073,741,824)$$

For example:

$$2KB = 2 \text{ kilobytes} = 2 \times 2^{10} \text{ bytes}$$

$$4MB = 4 \text{ megabytes} = 4 \times 2^{20} \text{ bytes}$$

$$8GB = 8 \text{ gigabytes} = 8 \times 2^{30} \text{ bytes}$$

$$2K \text{ pixels} = 2 \text{ kilopixels} = 2 \times 2^{10} \text{ pixels}$$

$$4M \text{ pixels} = 4 \text{ megapixels} = 4 \times 2^{20} \text{ pixels}$$

- Register Access

The abbreviations used to indicate the type of access to register fields and bits have the following definitions:

Abbreviation	Meaning
IGN	Ignore Bits and fields specified are ignored on writes.
MBZ	Must Be Zero Software must never place a nonzero value in bits and fields specified as MBZ. A nonzero read produces an Illegal Operand exception. Also, MBZ fields are reserved for future use.
RAZ	Read As Zero Bits and fields return a zero when read.
RC	Read Clears Bits and fields are cleared when read. Unless otherwise specified, such bits cannot be written.
RES	Reserved Bits and fields are reserved by Compaq and should not be used; however, zeros can be written to reserved fields that cannot be masked.
RO	Read Only The value may be read by software. It is written by hardware. Software write operations are ignored.
RO, <i>n</i>	Read Only, and takes the value <i>n</i> at power-on reset. The value may be read by software. It is written by hardware. Software write operations are ignored.

Abbreviation	Meaning
RW	Read/Write Bits and fields can be read and written.
RW, <i>n</i>	Read/Write, and takes the value <i>n</i> at power-on reset. Bits and fields can be read and written.
W1C	Write One to Clear If read operations are allowed to the register, then the value may be read by software. If it is a write-only register, then a read operation by software returns an UNPREDICTABLE result. Software write operations of a 1 cause the bit to be cleared by hardware. Software write operations of a 0 do not modify the state of the bit.
W1S	Write One to Set If read operations are allowed to the register, then the value may be read by software. If it is a write-only register, then a read operation by software returns an UNPREDICTABLE result. Software write operations of a 1 cause the bit to be set by hardware. Software write operations of a 0 do not modify the state of the bit.
WO	Write Only Bits and fields can be written but not read.
WO, <i>n</i>	Write Only, and takes the value <i>n</i> at power-on reset. Bits and fields can be written but not read.

- Sign extension
SEXT(*x*) means *x* is sign-extended to the required size.

Addresses

Unless otherwise noted, all addresses and offsets are hexadecimal.

Aligned and Unaligned

The terms *aligned* and *naturally aligned* are interchangeable and refer to data objects that are powers of two in size. An aligned datum of size $2n$ is stored in memory at a byte address that is a multiple of $2n$; that is, one that has *n* low-order zeros. For example, an aligned 64-byte stack frame has a memory address that is a multiple of 64.

A datum of size $2n$ is *unaligned* if it is stored in a byte address that is not a multiple of $2n$.

Bit Notation

Multiple-bit fields can include contiguous and noncontiguous bits contained in square brackets ([]). Multiple contiguous bits are indicated by a pair of numbers separated by a colon [:]. For example, [9:7,5,2:0] specifies bits 9,8,7,5,2,1, and 0. Similarly, single bits are frequently indicated with square brackets. For example, [27] specifies bit 27. See also Field Notation.

Caution

Cautions indicate potential damage to equipment or loss of data.

Data Units

The following data unit terminology is used throughout this manual.

Term	Words	Bytes	Bits	Other
Byte	½	1	8	—
Word	1	2	16	—
Longword	2	4	32	Dword
Quadword	4	8	64	2 longword

Do Not Care (X)

A capital X represents any valid value.

External

Unless otherwise stated, external means not contained in the chip.

Field Notation

The names of single-bit and multiple-bit fields can be used rather than the actual bit numbers (see Bit Notation). When the field name is used, it is contained in square brackets ([]). For example, **RegisterName[LowByte]** specifies **RegisterName[7:0]**.

Note

Notes emphasize particularly important information.

Numbering

All numbers are decimal or hexadecimal unless otherwise indicated. The prefix 0x indicates a hexadecimal number. For example, 19 is decimal, but 0x19 and 0x19A are hexadecimal (also see Addresses). Otherwise, the base is indicated by a subscript; for example, 100₂ is a binary number.

Ranges and Extents

Ranges are specified by a pair of numbers separated by two periods (..) and are inclusive. For example, a range of integers 0..4 includes the integers 0, 1, 2, 3, and 4.

Extents are specified by a pair of numbers in square brackets ([]) separated by a colon (:) and are inclusive. Bit fields are often specified as extents. For example, bits [7:3] specifies bits 7, 6, 5, 4, and 3.

Register Figures

The gray areas in register figures indicate reserved or unused bits and fields.

Bit ranges that are coupled with the field name specify the bits of the named field that are included in the register. The bit range may, but need not necessarily, correspond to the bit *Extent* in the register. See the explanation above Table 5–1 for more information.

Signal Names

The following examples describe signal-name conventions used in this document.

- AlphaSignal[n:n]** Boldface, mixed-case type denotes signal names that are assigned internal and external to the 21264/EV68A (that is, the signal traverses a chip interface pin).
- AlphaSignal_x[n:n]** When a signal has high and low assertion states, a lower-case italic *x* represents the assertion states. For example, **SignalName_x[3:0]** represents **SignalName_H[3:0]** and **SignalName_L[3:0]**.

UNDEFINED

Operations specified as UNDEFINED may vary from moment to moment, implementation to implementation, and instruction to instruction within implementations. The operation may vary in effect from nothing to stopping system operation.

UNDEFINED operations may halt the processor or cause it to lose information. However, UNDEFINED operations must not cause the processor to hang, that is, reach an unhalted state from which there is no transition to a normal state in which the machine executes instructions.

UNPREDICTABLE

UNPREDICTABLE results or occurrences do not disrupt the basic operation of the processor; it continues to execute instructions in its normal manner. Further:

- Results or occurrences specified as UNPREDICTABLE may vary from moment to moment, implementation to implementation, and instruction to instruction within implementations. Software can never depend on results specified as UNPREDICTABLE.
- An UNPREDICTABLE result may acquire an arbitrary value subject to a few constraints. Such a result may be an arbitrary function of the input operands or of any state information that is accessible to the process in its current access mode. UNPREDICTABLE results may be unchanged from their previous values.

Operations that produce UNPREDICTABLE results may also produce exceptions.

- An occurrence specified as UNPREDICTABLE may happen or not based on an arbitrary choice function. The choice function is subject to the same constraints as are UNPREDICTABLE results and, in particular, must not constitute a security hole.

Specifically, UNPREDICTABLE results must not depend upon, or be a function of, the contents of memory locations or registers that are inaccessible to the current process in the current access mode.

Also, operations that may produce UNPREDICTABLE results must not:

- Write or modify the contents of memory locations or registers to which the current process in the current access mode does not have access, or
- Halt or hang the system or any of its components.

For example, a security hole would exist if some UNPREDICTABLE result depended on the value of a register in another process, on the contents of processor temporary registers left behind by some previously running process, or on a sequence of actions of different processes.

X

Do not care. A capital X represents any valid value.

This chapter provides a brief introduction to the Alpha architecture, Compaq's RISC (reduced instruction set computing) architecture designed for high performance. The chapter then summarizes the specific features of the Alpha 21264/EV68A microprocessor (hereafter called the 21264/EV68A) that implements the Alpha architecture. Appendix A provides a list of Alpha instructions.

The companion volume to this document, the *Alpha Architecture Reference Manual, Fourth Edition*, contains the complete architecture information.

1.1 The Architecture

The Alpha architecture is a 64-bit load and store RISC architecture designed with particular emphasis on speed, multiple instruction issue, multiple processors, and software migration from many operating systems.

All registers are 64 bits long and all operations are performed between 64-bit registers. All instructions are 32 bits long. Memory operations are either load or store operations. All data manipulation is done between registers.

The Alpha architecture supports the following data types:

- 8-, 16-, 32-, and 64-bit integers
- IEEE 32-bit and 64-bit floating-point formats
- VAX architecture 32-bit and 64-bit floating-point formats

In the Alpha architecture, instructions interact with each other only by one instruction writing to a register or memory location and another instruction reading from that register or memory location. This use of resources makes it easy to build implementations that issue multiple instructions every CPU cycle.

The 21264/EV68A uses a set of subroutines, called privileged architecture library code (PALcode), that is specific to a particular Alpha operating system implementation and hardware platform. These subroutines provide operating system primitives for context switching, interrupts, exceptions, and memory management. These subroutines can be invoked by hardware or CALL_PAL instructions. CALL_PAL instructions use the function field of the instruction to vector to a specified subroutine. PALcode is written in standard machine code with some implementation-specific extensions to provide direct access to low-level hardware functions. PALcode supports optimizations for multiple operating systems, flexible memory-management implementations, and multi-instruction atomic sequences.

The Architecture

The Alpha architecture performs byte shifting and masking with normal 64-bit, register-to-register instructions. The 21264/EV68A performs single-byte and single-word load and store instructions.

1.1.1 Addressing

The basic addressable unit in the Alpha architecture is the 8-bit byte. The 21264/EV68A supports a 48-bit or 43-bit virtual address (selectable under IPR control).

Virtual addresses as seen by the program are translated into physical memory addresses by the memory-management mechanism. The 21264/EV68A supports a 44-bit physical address.

1.1.2 Integer Data Types

Alpha architecture supports the four integer data types listed in Table 1–1.

Table 1–1 Integer Data Types

Data Type	Description
Byte	A byte is 8 contiguous bits that start at an addressable byte boundary. A byte is an 8-bit value.
Word	A word is 2 contiguous bytes that start at an arbitrary byte boundary. A word is a 16-bit value.
Longword	A longword is 4 contiguous bytes that start at an arbitrary byte boundary. A longword is a 32-bit value.
Quadword	A quadword is 8 contiguous bytes that start at an arbitrary byte boundary.

Note: Alpha implementations may impose a significant performance penalty when accessing operands that are not naturally aligned. Refer to the *Alpha Architecture Handbook, Version 4* for details.

1.1.3 Floating-Point Data Types

The 21264/EV68A supports the following floating-point data types:

- Longword integer format in floating-point unit
- Quadword integer format in floating-point unit
- IEEE floating-point formats
 - S_floating
 - T_floating
- VAX floating-point formats
 - F_floating
 - G_floating
 - D_floating (limited support)

1.2 21264/EV68A Microprocessor Features

The 21264/EV68A microprocessor is a superscalar pipelined processor. It is packaged in a 587-pin PGA carrier and has removable application-specific heat sinks. A number of configuration options allow its use in a range of system designs ranging from extremely simple uniprocessor systems with minimum component count to high-performance multiprocessor systems with very high cache and memory bandwidth.

The 21264/EV68A can issue four Alpha instructions in a single cycle, thereby minimizing the average cycles per instruction (CPI). A number of low-latency and/or high-throughput features in the instruction issue unit and the onchip components of the memory subsystem further reduce the average CPI.

The 21264/EV68A and associated PALcode implements IEEE single-precision and double-precision, VAX F_floating and G_floating data types, and supports longword (32-bit) and quadword (64-bit) integers. Byte (8-bit) and word (16-bit) support is provided by byte-manipulation instructions. Limited hardware support is provided for the VAX D_floating data type.

Other 21264/EV68A features include:

- The ability to issue up to four instructions during each CPU clock cycle.
- A peak instruction execution rate of four times the CPU clock frequency.
- An onchip, demand-paged memory-management unit with translation buffer, which, when used with PALcode, can implement a variety of page table structures and translation algorithms. The unit consists of a 128-entry, fully-associative data translation buffer (DTB) and a 128-entry, fully-associative instruction translation buffer (ITB), with each entry able to map a single 8KB page or a group of 8, 64, or 512 8KB pages. The allocation scheme for the ITB and DTB is round-robin. The size of each translation buffer entry's group is specified by hint bits stored in the entry. The DTB and ITB implement 8-bit address space numbers (ASN), MAX_ASN=255.
- Two onchip, high-throughput pipelined floating-point units, capable of executing both VAX and IEEE floating-point data types.
- An onchip, 64KB virtually-addressed instruction cache with 8-bit ASNs (MAX_ASN=255).
- An onchip, virtually-indexed, physically-tagged dual-read-ported, 64KB data cache.
- Supports a 48-bit or 43-bit virtual address (program selectable).
- Supports a 44-bit physical address.
- An onchip I/O write buffer with four 64-byte entries for I/O write transactions.
- An onchip, 8-entry victim data buffer.
- An onchip, 32-entry load queue.
- An onchip, 32-entry store queue.
- An onchip, 8-entry miss address file for cache fill requests and I/O read transactions.
- An onchip, 8-entry probe queue, holding pending system port probe commands.

21264/EV68A Microprocessor Features

- An onchip, duplicate tag array used to maintain level 2 cache coherency.
- A 64-bit data bus with onchip parity and error correction code (ECC) support.
- Support for an external second-level (Bcache) cache. The size and some timing parameters of the Bcache are programmable.
- An internal clock generator providing a high-speed clock used by the 21264/EV68A, and two clocks for use by the CPU module.
- Onchip performance counters to measure and analyze CPU and system performance.
- Chip and module level test support, including an instruction cache test interface to support chip and module level testing.
- A 2.0-V external interface.

Refer to Chapter 9 for 21264/EV68A dc and ac electrical characteristics. Refer to the *Alpha Architecture Handbook, Version 4*, Appendix E, for waivers and any other implementation-dependent information.

Internal Architecture

This chapter provides both an overview of the 21264/EV68A microarchitecture and a system designer's view of the 21264/EV68A implementation of the Alpha architecture. The combination of the 21264/EV68A microarchitecture and privileged architecture library code (PALcode) defines the chip's implementation of the Alpha architecture. If a certain piece of hardware seems to be "architecturally incomplete," the missing functionality is implemented in PALcode. Chapter 6 provides more information on PALcode.

This chapter describes the major functional hardware units and is not intended to be a detailed hardware description of the chip. It is organized as follows:

- 21264/EV68A microarchitecture
- Pipeline organization
- Instruction issue and retire rules
- Load instructions to R31/F31 (software-directed instruction prefetch)
- Special cases of Alpha instruction execution
- Memory and I/O address space
- Miss address file (MAF) and load-merging rules
- Instruction ordering
- Replay traps
- I/O write buffer and the WMB instruction
- Performance measurement support
- Floating-point control register
- AMASK and IMPLVER instruction values
- Design examples

2.1 21264/EV68A Microarchitecture

The 21264/EV68A microprocessor is a high-performance third-generation implementation of the Compaq Alpha architecture. The 21264/EV68A consists of the following sections, as shown in Figure 2-1:

- Instruction fetch, issue, and retire unit (Ibox)
- Integer execution unit (Ebox)

- Floating-point execution unit (Fbox)
- Onchip caches (Icache and Dcache)
- Memory reference unit (Mbox)
- External cache and system interface unit (Cbox)
- Pipeline operation sequence

2.1.1 Instruction Fetch, Issue, and Retire Unit

The instruction fetch, issue, and retire unit (Ibox) consists of the following subsections:

- Virtual program counter logic
- Branch predictor
- Instruction-stream translation buffer (ITB)
- Instruction fetch logic
- Register rename maps
- Integer and floating-point issue queues
- Exception and interrupt logic
- Retire logic

2.1.1.1 Virtual Program Counter Logic

The virtual program counter (VPC) logic maintains the virtual addresses for instructions that are in flight. There can be up to 80 instructions, in 20 successive fetch slots, in flight between the register rename mappers and the end of the pipeline. The VPC logic contains a 20-entry table to store these fetched VPC addresses.

Figure 2–1 21264/EV68A Block Diagram

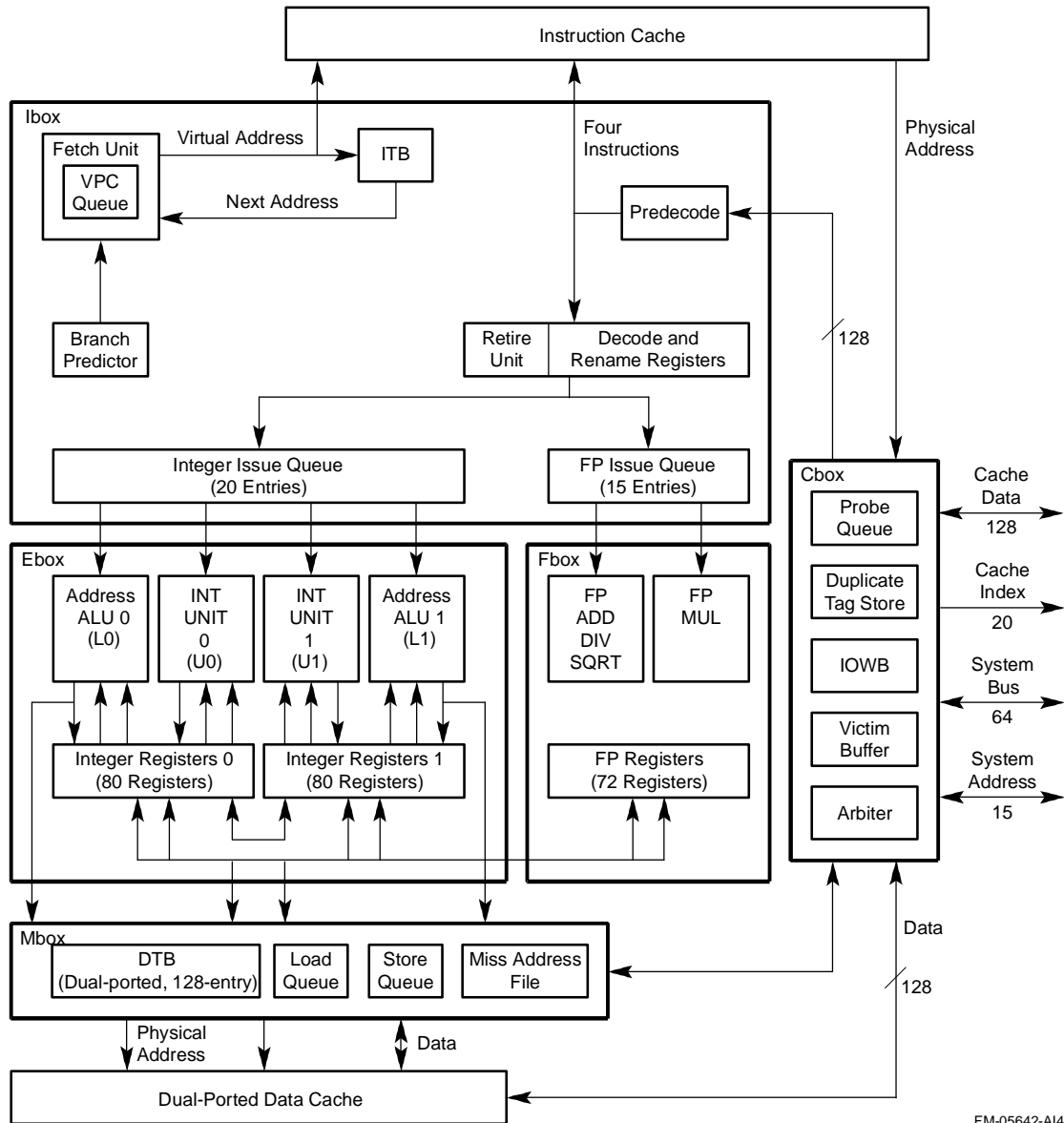

FM-05642-A14

2.1.1.2 Branch Predictor

The branch predictor is composed of three units: the local, global, and choice predictors. Figure 2–2 shows how the branch predictor generates the predicted branch address.

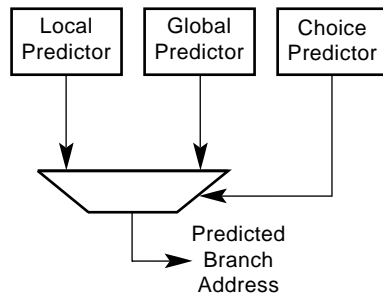
Figure 2–2 Branch Predictor

FM-05810.A14

Local Predictor

The local predictor uses a 2-level table that holds the history of individual branches. The 2-level table design approaches the prediction accuracy of a larger single-level table while requiring fewer total bits of storage. Figure 2–3 shows how the local predictor generates a prediction. Bits [11:2] of the VPC of the current branch are used as the index to a 1K entry table in which each entry is a 10-bit value. This 10-bit value is used as the index to a 1K entry table of 3-bit saturating counters. The value of the saturating counter determines the predication, taken/not-taken, of the current branch.

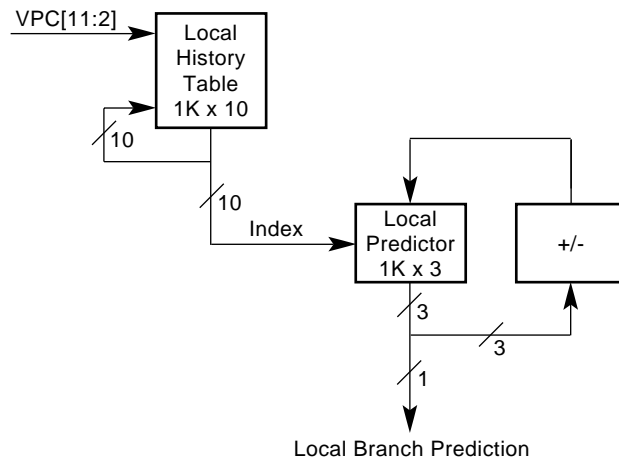
Figure 2–3 Local Predictor

FM-05811.A14

Global Predictor

The global predictor is indexed by a global history of all recent branches. The global predictor correlates the local history of the current branch with all recent branches. Figure 2–4 shows how the global predictor generates a prediction. The global path history is comprised of the taken/not-taken state of the 12 most-recent branches. These 12 states are used to form an index into a 4K entry table of 2-bit saturating counters. The value of the saturating counter determines the predication, taken/not-taken, of the current branch.

Figure 2–4 Global Predictor

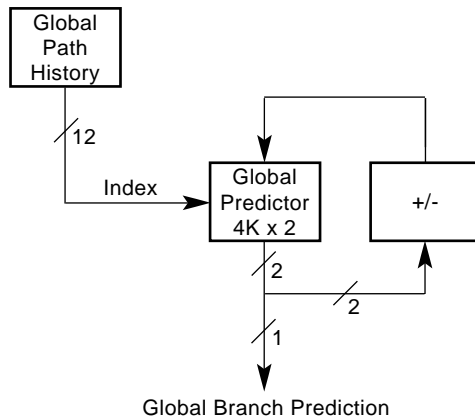

FM-05812.AI4

Choice Predictor

The choice predictor monitors the history of the local and global predictors and chooses the best of the two predictors for a particular branch. Figure 2–5 shows how the choice predictor generates its choice of the result of the local or global prediction. The 12-bit global path history (see Figure 2–4) is used to index a 4K entry table of 2-bit saturating counters. The value of the saturating counter determines the choice between the outputs of the local and global predictors.

Figure 2–5 Choice Predictor

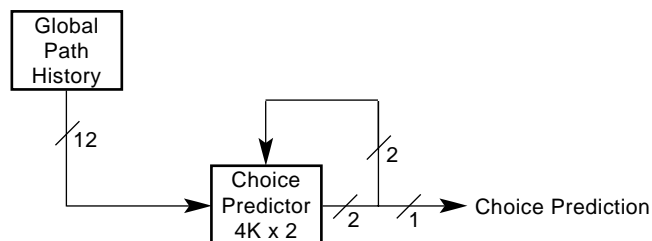

FM-05813.AI4

2.1.1.3 Instruction-Stream Translation Buffer

The Ibox includes a 128-entry, fully-associative instruction-stream translation buffer (ITB) that is used to store recently used instruction-stream (Istream) address translations and page protection information. Each of the entries in the ITB can map 1, 8, 64, or 512 contiguous 8KB pages. The allocation scheme is round-robin.

The ITB supports an 8-bit ASN and contains an ASM bit. The Icache is virtually addressed and contains the access-check information, so the ITB is accessed only for Istream references that miss in the Icache.

Istream transactions to I/O address space are UNDEFINED.

2.1.1.4 Instruction Fetch Logic

The instruction prefetcher (predecode) reads an octaword, containing up to four naturally aligned instructions per cycle, from the Icache. Branch prediction and line prediction bits accompany the four instructions. The branch prediction scheme operates most efficiently when only one branch instruction is contained among the four fetched instructions. The line prediction scheme attempts to predict the Icache line that the branch predictor will generate, and is described in Section 2.2.

An entry from the subroutine return prediction stack, together with set prediction bits for use by the Icache stream controller, are fetched along with the octaword. The Icache stream controller generates fetch requests for additional Icache lines and stores the Istream data in the Icache. There is no separate buffer to hold Istream requests.

2.1.1.5 Register Rename Maps

The instruction prefetcher forwards instructions to the integer and floating-point register rename maps. The rename maps perform the two functions listed here:

- Eliminate register write-after-read (WAR) and write-after-write (WAW) data dependencies while preserving true read-after-write (RAW) data dependencies, in order to allow instructions to be dynamically rescheduled.
- Provide a means of speculatively executing instructions before the control flow previous to those instructions is resolved. Both exceptions and branch mispredictions represent deviations from the control flow predicted by the instruction prefetcher.

The map logic translates each instruction's operand register specifiers from the *virtual* register numbers in the instruction to the *physical* register numbers that hold the corresponding architecturally-correct values. The map logic also renames each instruction's destination register specifier from the virtual number in the instruction to a physical register number chosen from a list of free physical registers, and updates the register maps.

The map logic can process four instructions per cycle. It does not return the physical register, which holds the old value of an instruction's virtual destination register, to the free list until the instruction has been retired, indicating that the control flow up to that instruction has been resolved.

If a branch mispredict or exception occurs, the map logic backs up the contents of the integer and floating-point register rename maps to the state associated with the instruction that triggered the condition, and the prefetcher restarts at the appropriate VPC. At most, 20 valid fetch slots containing up to 80 instructions can be in flight between the register maps and the end of the machine's pipeline, where the control flow is finally resolved. The map logic is capable of backing up the contents of the maps to the state associated with any of these 80 instructions in a single cycle.

The register rename logic places instructions into an integer or floating-point issue queue, from which they are later issued to functional units for execution.

2.1.1.6 Integer Issue Queue

The 20-entry integer issue queue (IQ), associated with the integer execution units (Ebox), issues the following types of instructions at a maximum rate of four per cycle:

- Integer operate
- Integer conditional branch
- Unconditional branch – both displacement and memory format
- Integer and floating-point load and store
- PAL-reserved instructions: HW_MTPR, HW_MFPR, HW_LD, HW_ST, HW_RET
- Integer-to-floating-point (ITOF_x) and floating-point-to-integer (FTOI_x)

Each queue entry asserts four request signals—one for each of the Ebox subclusters. A queue entry asserts a request when it contains an instruction that can be executed by the subcluster, if the instruction's operand register values are available within the subcluster.

There are two arbiters—one for the upper subclusters and one for the lower subclusters. (Subclusters are described in Section 2.1.2.) Each arbiter picks two of the possible 20 requesters for service each cycle. A given instruction only requests upper subclusters or lower subclusters, but because many instructions can only be executed in one type or another this is not too limiting.

For example, load and store instructions can only go to lower subclusters and shift instructions can only go to upper subclusters. Other instructions, such as addition and logic operations, can execute in either upper or lower subclusters and are statically assigned before being placed in the IQ.

The IQ arbiters choose between simultaneous requesters of a subcluster based on the age of the request—older requests are given priority over newer requests. If a given instruction requests both lower subclusters, and no older instruction requests a lower subcluster, then the arbiter assigns subcluster L0 to the instruction. If a given instruction requests both upper subclusters, and no older instruction requests an upper subcluster, then the arbiter assigns subcluster U1 to the instruction. This asymmetry between the upper and lower subcluster arbiters is a circuit implementation optimization with negligible overall performance effect.

2.1.1.7 Floating-Point Issue Queue

The 15-entry floating-point issue queue (FQ) associated with the Fbox issues the following instruction types:

- Floating-point operates
- Floating-point conditional branches
- Floating-point stores
- Floating-point register to integer register transfers (FTOI_x)

Each queue entry has three request lines—one for the add pipeline, one for the multiply pipeline, and one for the two store pipelines. There are three arbiters—one for each of the add, multiply, and store pipelines. The add and multiply arbiters pick one requester per cycle, while the store pipeline arbiter picks two requesters per cycle, one for each store pipeline.

The FQ arbiters pick between simultaneous requesters of a pipeline based on the age of the request—older requests are given priority over newer requests. Floating-point store instructions and FTOLx instructions in even-numbered queue entries arbitrate for one store port. Floating-point store instructions and FTOLx instructions in odd-numbered queue entries arbitrate for the second store port.

Floating-point store instructions and FTOLx instructions are queued in both the integer and floating-point queues. They wait in the floating-point queue until their operand register values are available. They subsequently request service from the store arbiter. Upon being issued from the floating-point queue, they signal the corresponding entry in the integer queue to request service. Upon being issued from the integer queue, the operation is completed.

2.1.1.8 Exception and Interrupt Logic

There are two types of exceptions: faults and synchronous traps. Arithmetic exceptions are precise and are reported as synchronous traps.

The four sources of interrupts are listed as follows:

- Level-sensitive hardware interrupts sourced by the **IRQ_H[5:0]** pins
- Edge-sensitive hardware interrupts generated by the serial line receive pin, performance counter overflows, and hardware corrected read errors
- Software interrupts sourced by the software interrupt request (SIRR) register
- Asynchronous system traps (ASTs)

Interrupt sources can be individually masked. In addition, AST interrupts are qualified by the current processor mode.

2.1.1.9 Retire Logic

The Ibox fetches instructions in program order, executes them out of order, and then retires them in order. The Ibox retire logic maintains the architectural state of the machine by retiring an instruction only if all previous instructions have executed without generating exceptions or branch mispredictions. Retiring an instruction commits the machine to any changes the instruction may have made to the software-visible state.

The three software-visible states are listed as follows:

- Integer and floating-point registers
- Memory
- Internal processor registers (including control/status registers and translation buffers)

The retire logic can sustain a maximum retire rate of eight instructions per cycle, and can retire up to as many as 11 instructions in a single cycle.

2.1.2 Integer Execution Unit

The integer execution unit (Ebox) is a 4-path integer execution unit that is implemented as two functional-unit “clusters” labeled 0 and 1. Each cluster contains a copy of an 80-entry, physical-register file and two “subclusters”, named upper (U) and lower (L). Figure 2–6 shows the integer execution unit. In the figure, *iop_wr* is the cross-cluster bus for moving integer result values between clusters.

Figure 2–6 Integer Execution Unit—Clusters 0 and 1

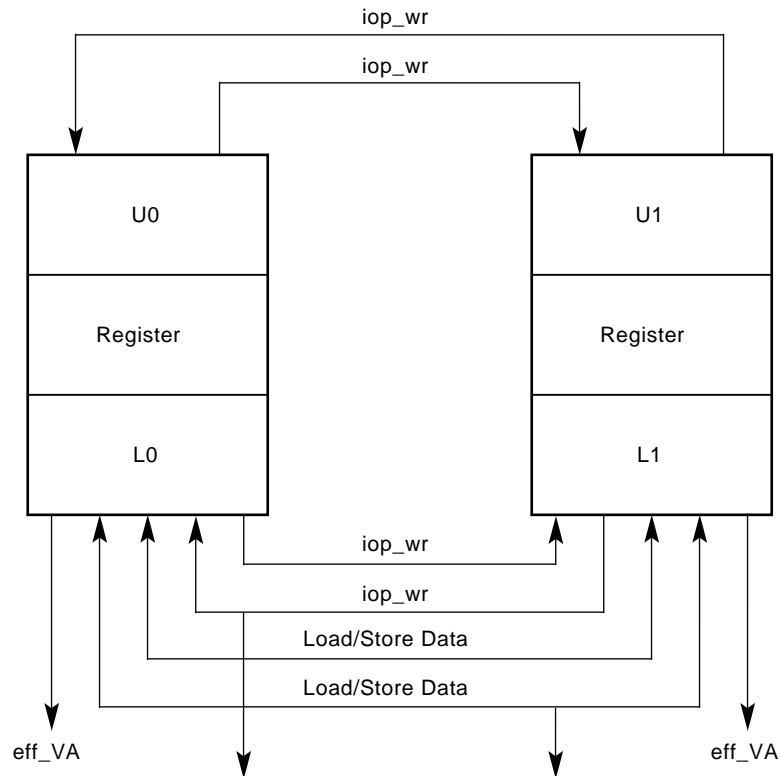

FM-05643.A14

Most instructions have 1-cycle latency for consumers that execute within the same cluster. Also, there is another 1-cycle delay associated with producing a value in one cluster and consuming the value in the other cluster. The instruction issue queue minimizes the performance effect of this cross-cluster delay. The Ebox contains the following resources:

- Four 64-bit adders that are used to calculate results for integer add instructions (located in U0, U1, L0, and L1)
- The adders in the lower subclusters that are used to generate the effective virtual address for load and store instructions (located in L0 and L1)
- Four logic units
- Two barrel shifters and associated byte logic (located in U0 and U1)
- Two sets of conditional branch logic (located in U0 and U1)
- Two copies of an 80-entry register file
- One pipelined multiplier (located in U1) with 7-cycle latency for all integer multiply operations
- One fully-pipelined unit (located in U0), with 3-cycle latency, that executes the following instructions:
 - CTLZ, CTPOP, CTTZ
 - PERR, MINxxx, MAXxxx, UNPKxx, PKxx

The Ebox has 80 register-file entries that contain storage for the values of the 31 Alpha integer registers (the value of R31 is not stored), the values of 8 PALshadow registers, and 41 results written by instructions that have not yet been retired.

Ignoring cross-cluster delay, the two copies of the Ebox register file contain identical values. Each copy of the Ebox register file contains four read ports and six write ports. The four read ports are used to source operands to each of the two subclusters within a cluster. The six write ports are used as follows:

- Two write ports are used to write results generated within the cluster.
- Two write ports are used to write results generated by the other cluster.
- Two write ports are used to write results from load instructions. These two ports are also used for FTOLx instructions.

2.1.3 Floating-Point Execution Unit

The floating-point execution unit (Fbox) has two paths. The Fbox executes both VAX and IEEE floating-point instructions. It supports IEEE S_floating-point and T_floating-point data types and all rounding modes. It also supports VAX F_floating-point and G_floating-point data types, and provides limited support for D_floating-point format. The basic structure of the floating-point execution unit is shown in Figure 2–7.

Figure 2–7 Floating-Point Execution Units

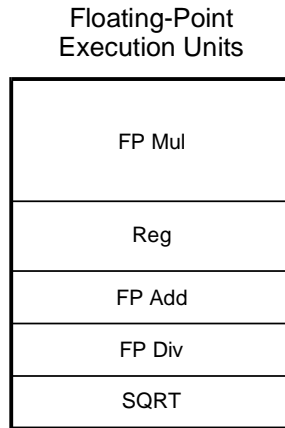

LK98-0004A

The Fbox contains the following resources:

- 72-entry physical register file
- Fully-pipelined multiplier with 4-cycle latency
- Fully-pipelined adder with 4-cycle latency
- Nonpipelined divide unit associated with the adder pipeline
- Nonpipelined square root unit associated with the adder pipeline

The 72 Fbox register file entries contain storage for the values of the 31 Alpha floating-point registers (F31 is not stored) and 41 values written by instructions that have not been retired.

The Fbox register file contains six read ports and four write ports. Four read ports are used to source operands to the add and multiply pipelines, and two read ports are used to source data for store instructions. Two write ports are used to write results generated by the add and multiply pipelines, and two write ports are used to write results from floating-point load instructions.

2.1.4 External Cache and System Interface Unit

The interface for the system and external cache (Cbox) controls the Bcache and system ports. It contains the following structures:

- Victim address file (VAF)
- Victim data file (VDF)
- I/O write buffer (IOWB)
- Probe queue (PQ)
- Duplicate Dcache tag (DTAG)

2.1.4.1 Victim Address File and Victim Data File

The victim address file (VAF) and victim data file (VDF) together form an 8-entry victim buffer used for holding:

- Dcache blocks to be written to the Bcache
- Istream cache blocks from memory to be written to the Bcache
- Bcache blocks to be written to memory
- Cache blocks sent to the system in response to probe commands

2.1.4.2 I/O Write Buffer

The I/O write buffer (IOWB) consists of four 64-byte entries and associated address and control logic used for buffering I/O write data between the store queue and the system port.

2.1.4.3 Probe Queue

The probe queue (PQ) is an 8-entry queue that holds pending system port cache probe commands and addresses.

2.1.4.4 Duplicate Dcache Tag Array

The duplicate Dcache tag (DTAG) array holds a duplicate copy of the Dcache tags and is used by the Cbox when processing Dcache fills, Icache fills, and system port probes.

2.1.5 Onchip Caches

The 21264/EV68A contains two onchip primary-level caches.

2.1.5.1 Instruction Cache

The instruction cache (Icache) is a 64KB virtual-addressed, 2-way set-predict cache. Set prediction is used to approximate the performance of a 2-set cache without slowing the cache access time. Each Icache block contains:

- 16 Alpha instructions (64 bytes)

- Virtual tag bits [47:15]
- 8-bit address space number (ASN) field
- 1-bit address space match (ASM) bit
- 1-bit PALcode bit to indicate physical addressing
- Valid bit
- Data and tag parity bits
- Four access-check bits for the following modes: kernel, executive, supervisor, and user (KESU)
- Additional predecoded information to assist with instruction processing and fetch control

2.1.5.2 Data Cache

The data cache (Dcache) is a 64KB, 2-way set-associative, virtually indexed, physically tagged, write-back, read/write allocate cache with 64-byte blocks. During each cycle the Dcache can perform one of the following transactions:

- Two quadword (or shorter) read transactions to arbitrary addresses
- Two quadword write transactions to the same aligned octaword
- Two non-overlapping less-than-quadword writes to the same aligned quadword
- One sequential read and write transaction from and to the same aligned octaword

Each Dcache block contains:

- 64 data bytes and associated quadword ECC bits
- Physical tag bits
- Valid, dirty, shared, and modified bits
- Tag parity bit calculated across the tag, dirty, shared, and modified bits
- One bit to control round-robin set allocation (one bit per two cache blocks)

The Dcache contains two sets, each with 512 rows containing 64-byte blocks per row (that is, 32K bytes of data per set). The 21264/EV68A requires two additional bits of virtual address beyond the bits that specify an 8KB page, in order to specify a Dcache row index. A given virtual address might be found in four unique locations in the Dcache, depending on the virtual-to-physical translation for those two bits. The 21264/EV68A prevents this aliasing by keeping only one of the four possible translated addresses in the cache at any time.

2.1.6 Memory Reference Unit

The memory reference unit (Mbox) controls the Dcache and ensures architecturally correct behavior for load and store instructions. The Mbox contains the following structures:

- Load queue (LQ)
- Store queue (SQ)

- Miss address file (MAF)
- Dstream translation buffer (DTB)

2.1.6.1 Load Queue

The load queue (LQ) is a reorder buffer for load instructions. It contains 32 entries and maintains the state associated with load instructions that have been issued to the Mbox, but for which results have not been delivered to the processor and the instructions retired. The Mbox assigns load instructions to LQ slots based on the order in which they were fetched from the Icache, then places them into the LQ after they are issued by the IQ. The LQ helps ensure correct Alpha memory reference behavior.

2.1.6.2 Store Queue

The store queue (SQ) is a reorder buffer and graduation unit for store instructions. It contains 32 entries and maintains the state associated with store instructions that have been issued to the Mbox, but for which data has not been written to the Dcache and the instruction retired. The Mbox assigns store instructions to SQ slots based on the order in which they were fetched from the Icache and places them into the SQ after they are issued by the IQ. The SQ holds data associated with store instructions issued from the IQ until they are retired, at which point the store can be allowed to update the Dcache. The SQ also helps ensure correct Alpha memory reference behavior.

2.1.6.3 Miss Address File

The 8-entry miss address file (MAF) holds physical addresses associated with pending Icache and Dcache fill requests and pending I/O space read transactions.

2.1.6.4 Dstream Translation Buffer

The Mbox includes a 128-entry, fully associative Dstream translation buffer (DTB) used to store Dstream address translations and page protection information. Each of the entries in the DTB can map 1, 8, 64, or 512 contiguous 8KB pages. The allocation scheme is round-robin. The DTB supports an 8-bit ASN and contains an ASM bit.

2.1.7 SRAM Interface

The serial read-only memory (SRAM) interface provides the initialization data load path from a system SRAM to the Icache. Refer to Chapter 7 for more information.

2.2 Pipeline Organization

The 7-stage pipeline provides an optimized environment for executing Alpha instructions. The pipeline stages (0 to 6) are shown in Figure 2–8 and described in the following paragraphs.

Pipeline Organization

Figure 2–8 Pipeline Organization

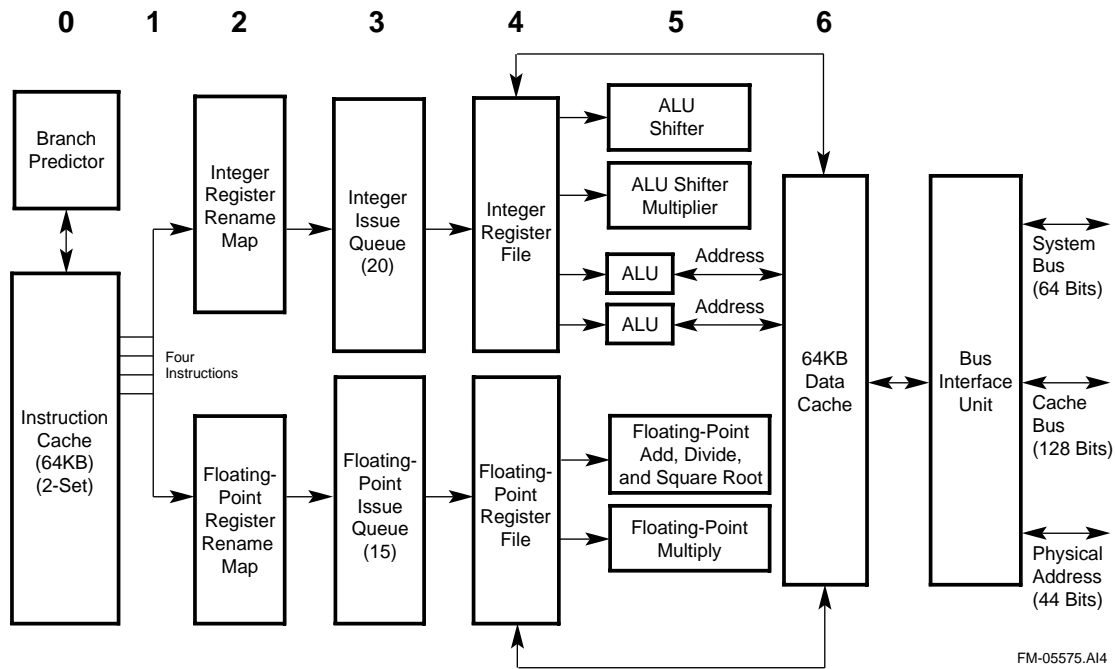

FM-05575.A14

Stage 0 — Instruction Fetch

The branch predictor uses a branch history algorithm to predict a branch instruction target address.

Up to four aligned instructions are fetched from the Icache, in program order. The branch prediction tables are also accessed in this cycle. The branch predictor uses tables and a branch history algorithm to predict a branch instruction target address for one branch or memory format JSR instruction per cycle. Therefore, the prefetcher is limited to fetching through one branch per cycle. If there is more than one branch within the fetch line, and the branch predictor predicts that the first branch will not be taken, it will predict through subsequent branches at the rate of one per cycle, until it predicts a taken branch or predicts through the last branch in the fetch line.

The Icache array also contains a line prediction field, the contents of which are applied to the Icache in the next cycle. The purpose of the line predictor is to remove the pipeline bubble which would otherwise be created when the branch predictor predicts a branch to be taken. In effect, the line predictor attempts to predict the Icache line which the branch predictor will generate. On fills, the line predictor value at each fetch line is initialized with the index of the next sequential fetch line, and later retrained by the branch predictor if necessary.

Stage 1 — Instruction Slot

The Ibox maps four instructions per cycle from the 64KB 2-way set-predict Icache. Instructions are mapped in order, executed dynamically, but are retired in order.

In the slot stage, the branch predictor compares the next Icache index that it generates to the index that was generated by the line predictor. If there is a mismatch, the branch predictor wins—the instructions fetched during that cycle are aborted, and the index predicted by the branch predictor is applied to the Icache during the next cycle. Line mispredictions result in one pipeline bubble.

The line predictor takes precedence over the branch predictor during memory format calls or jumps. If the line predictor was trained with a true (as opposed to predicted) memory format call or jump target, then its contents take precedence over the target hint field associated with these instructions. This allows dynamic calls or jumps to be correctly predicted.

The instruction fetcher produces the full VPC address during the fetch stage of the pipeline. The Icache produces the tags for both Icache sets 0 and 1 each time it is accessed. That enables the fetcher to separate set mispredictions from true Icache misses. If the access was caused by a set misprediction, the instruction fetcher aborts the last two fetched slots and refetches the slot in the next cycle. It also retrains the appropriate set prediction bits.

The instruction data is transferred from the Icache to the integer and floating-point register map hardware during this stage. When the integer instruction is fetched from the Icache and slotted into the IQ, the slot logic determines whether the instruction is for the upper or lower subclusters. The slot logic makes the decision based on the resources needed by the (up to four) integer instructions in the fetch block. Although all four instructions need not be issued simultaneously, distributing their resource usage improves instruction loading across the units. For example, if a fetch block contains two instructions that can be placed in either cluster followed by two instructions that must execute in the lower cluster, the slot logic would designate that combination as EELL and slot them as UULL. Slot combinations are described in Section 2.3.2 and Table 2–3.

Stage 2 — Map

Instructions are sent from the Icache to the integer and floating-point register maps during the slot stage and register renaming is performed during the map stage. Also, each instruction is assigned a unique 8-bit number, called an *inum*, which is used to identify the instruction and its program order with respect to other instructions during the time that it is in flight. Instructions are considered to be in flight between the time they are mapped and the time they are retired.

Mapped instructions and their associated inums are placed in the integer and floating-point queues by the end of the map stage.

Stage 3 — Issue

The 20-entry integer issue queue (IQ) issues instructions at the rate of four per cycle. The 15-entry floating-point issue queue (FQ) issues floating-point operate instructions, conditional branch instructions, and store instructions, at the rate of two per cycle. Normally, instructions are deleted from the IQ or FQ two cycles after they are issued. For example, if an instruction is issued in cycle n , it remains in the FQ or IQ in cycle $n+1$ but does not request service, and is deleted in cycle $n+2$.

Instruction Issue Rules

Stage 4 — Register Read

Instructions issued from the issue queues read their operands from the integer and floating-point register files and receive bypass data.

Stage 5 — Execute

The Ebox and Fbox pipelines begin execution.

Stage 6 — Dcache Access

Memory reference instructions access the Dcache and data translation buffers. Normally load instructions access the tag and data arrays while store instructions only access the tag arrays. Store data is written to the store queue where it is held until the store instruction is retired. Most integer operate instructions write their register results in this cycle.

2.2.1 Pipeline Aborts

The abort penalty as given is measured from the cycle after the fetch stage of the instruction which triggers the abort to the fetch stage of the new target, ignoring any Ibox pipeline stalls or queuing delay that the triggering instruction might experience. Table 2–1 lists the timing associated with each common source of pipeline abort.

Table 2–1 Pipeline Abort Delay (GCLK Cycles)

Abort Condition	Penalty (Cycles)	Comments
Branch misprediction	7	Integer or floating-point conditional branch misprediction.
JSR misprediction	8	Memory format JSR or HW_RET.
Mbox order trap	14	Load-load order or store-load order.
Other Mbox replay traps	13	—
DTB miss	13	—
ITB miss	7	—
Integer arithmetic trap	12	—
Floating-point arithmetic trap	13+latency	Add latency of instruction. See Section 2.3.3 for instruction latencies.

2.3 Instruction Issue Rules

This section defines instruction classes, the functional unit pipelines to which they are issued, and their associated latencies.

2.3.1 Instruction Group Definitions

Table 2–2 lists the instruction class, the pipeline assignments, and the instructions included in the class.

Table 2–2 Instruction Name, Pipeline, and Types

Class Name	Pipeline	Instruction Type
ild	L0, L1	All integer load instructions
fld	L0, L1	All floating-point load instructions
ist	L0, L1	All integer store instructions
fst	FST0, FST1, L0, L1	All floating-point store instructions
lda	L0, L1, U0, U1	LDA, LDAH
mem_misc	L1	WH64, ECB, WMB
rpcc	L1	RPCC
rx	L1	RS, RC
mxpr	L0, L1 (depends on IPR)	HW_MTPR, HW_MFPR
icbr	U0, U1	Integer conditional branch instructions
jsr	L0	BR, BSR, JMP, CALL, RET, COR, HW_RET, CALL_PAL
iadd	L0, U0, L1, U1	Instructions with opcode 10_{16} , except CMPBGE
ilog	L0, U0, L1, U1	AND, BIC, BIS, ORNOT, XOR, EQV, CMPBGE
ishf	U0, U1	Instructions with opcode 12_{16}
cmov	L0, U0, L1, U1	Integer CMOV — either cluster
imul	U1	Integer multiply instructions
imisc	U0	CTLZ, CTPOP, CTTZ, PERR, MIN _{xxx} , MAX _{xxx} , PK _{xx} , UNPK _{xx}
fcbr	FA	Floating-point conditional branch instructions
fadd	FA	All floating-point operate instructions except multiply, divide, square root, and conditional move instructions
fmul	FM	Floating-point multiply instruction
fcmov1	FA	Floating-point CMOV—first half
fcmov2	FA	Floating-point CMOV—second half
fdiv	FA	Floating-point divide instruction
fsqrt	FA	Floating-point square root instruction
nop	None	TRAP, EXCB, UNOP - LDQ_U R31, 0(Rx)

Table 2–2 Instruction Name, Pipeline, and Types (Continued)

Class Name	Pipeline	Instruction Type
ftoi	FST0, FST1, L0, L1	FTOIS, FTOIT
itof	L0, L1	ITOFS, ITOFF, ITOFT
mx_fpcr	FM	Instructions that move data from the floating-point control register

2.3.2 Ebox Slotting

Instructions that are issued from the IQ, and could execute in either upper or lower Ebox subclusters, are slotted to one pair or the other during the pipeline mapping stage based on the instruction mixture in the fetch line. The codes that are used in Table 2–3 are as follows:

- U—The instruction only executes in an upper subcluster.
- L—The instruction only executes in a lower subcluster.
- E—The instruction could execute in either an upper or lower subcluster.

Table 2–3 defines the slotting rules. The table field *Instruction Class 3, 2, 1 and 0* identifies each instruction’s location in the fetch line by the value of bits [3:2] in its PC.

Table 2–3 Instruction Group Definitions and Pipeline Unit

Instruction Class 3 2 1 0	Slotting 3 2 1 0	Instruction Class 3 2 1 0	Slotting 3 2 1 0
EEEE	ULUL	LLLL	LLLL
EEEL	ULUL	LLLU	LLLU
EEEU	ULLU	LLUE	LLUU
EELE	ULLU	LLUL	LLUL
EELL	UULL	LLUU	LLUU
EELU	ULLU	LUEE	LULU
EEUE	ULUL	LUEL	LUUL
EEUL	ULUL	LUEU	LULU
EEUU	LLUU	LULE	LULU
ELEE	ULUL	LULL	LULL
ELEL	ULUL	LULU	LULU
ELEU	ULLU	LUUE	LUUL
ELLE	ULLU	LUUL	LUUL
ELLL	ULLL	LUUU	LUUU
ELLU	ULLU	UEEE	ULUL
ELUE	ULUL	UEEL	ULUL
ELUL	ULUL	UEEU	ULLU

Table 2–3 Instruction Group Definitions and Pipeline Unit (Continued)

Instruction Class 3 2 1 0	Slotting 3 2 1 0	Instruction Class 3 2 1 0	Slotting 3 2 1 0
ELUU	LLUU	UELE	ULLU
EUEE	LULU	UELL	UULL
EUEL	LUUL	UELU	ULLU
EUEU	LULU	UEUE	ULUL
EULE	LULU	UEUL	ULUL
EULL	UULL	UEUU	ULUU
EULU	LULU	ULEE	ULUL
EUUE	LUUL	ULEL	ULUL
EUUL	LUUL	ULEU	ULLU
EUUU	LUUU	ULLE	ULLU
LEEE	LULU	ULLL	ULLL
LEEL	LUUL	ULLU	ULLU
LEEU	LULU	ULUE	ULUL
LELE	LULU	ULUL	ULUL
LELL	LULL	ULUU	ULUU
LELU	LULU	UUEE	UULL
LEUE	LUUL	UUEL	UULL
LEUL	LUUL	UUEU	UULU
LEUU	LLUU	UULE	UULL
LLEE	LLUU	UULL	UULL
LLEL	LLUL	UULU	UULU
LLEU	LLUU	UUUE	UUUL
LLLE	LLLU	UUUL	UUUL
—	—	UUUU	UUUU

Instruction Issue Rules

2.3.3 Instruction Latencies

After an instruction is placed in the IQ or FQ, its issue point is determined by the availability of its register operands, functional unit(s), and relationship to other instructions in the queue. There are register producer-consumer dependencies and dynamic functional unit availability dependencies that affect instruction issue. The mapper removes register producer-producer dependencies.

The latency to produce a register result is generally fixed. The one exception is for load instructions that miss the Dcache. Table 2–4 lists the latency, in cycles, for each instruction class.

Table 2–4 Instruction Class Latency in Cycles

Class	Latency	Comments
ild	3 13+	Dcache hit. Dcache miss, latency with 6-cycle Bcache. Add additional Bcache loop latency if Bcache latency is greater than 6 cycles.
fld	4 14+	Dcache hit. Dcache miss, latency with 6-cycle Bcache. Add additional Bcache loop latency if Bcache latency is greater than 6 cycles.
lda	1	Possible 1-cycle Ebox cross-cluster delay.
mem_misc	—	Does not produce register value.
ist	—	Does not produce register value.
fst	—	Does not produce register value.
rpcc	1	Possible 1-cycle cross-cluster delay.
rx	1	—
mxpr	1 or 3	HW_MFPR: Ebox IPRs = 1. Ibox and Mbox IPRs = 3. HW_MTPR does not produce a register value.
icbr	—	Conditional branch. Does not produce register value.
ubr	3	Unconditional branch. Does not produce register value.
jsr	3	—
iadd	1	Possible 1-cycle Ebox cross-cluster delay.
ilog	1	Possible 1-cycle Ebox cross-cluster delay.
ishf	1	Possible 1-cycle Ebox cross-cluster delay.
cmov1	1	Only consumer is cmov2. Possible 1-cycle Ebox cross-cluster delay.
cmov2	1	Possible 1-cycle Ebox cross-cluster delay.
imul	7	Possible 1-cycle Ebox cross-cluster delay.
imisc	3	Possible 1-cycle Ebox cross-cluster delay.
fcbr	—	Does not produce register value.

Table 2–4 Instruction Class Latency in Cycles (Continued)

Class	Latency	Comments
fadd	4	Consumer other than fst or ftoi.
	6	Consumer fst or ftoi. Measured from when an fadd is issued from the FQ to when an fst or ftoi is issued from the IQ.
fmul	4	Consumer other than fst or ftoi.
	6	Consumer fst or ftoi. Measured from when an fmul is issued from the FQ to when an fst or ftoi is issued from the IQ.
fcmov1	4	Only consumer is fcmov2.
fcmov2	4	Consumer other than fst.
	6	Consumer fst or ftoi. Measured from when an fcmov2 is issued from the FQ to when an fst or ftoi is issued from the IQ.
fdiv	12	Single precision - latency to consumer of result value.
	9	Single precision - latency to using divider again.
	15	Double precision - latency to consumer of result value.
	12	Double precision - latency to using divider again.
fsqrt	18	Single precision - latency to consumer of result value.
	15	Single precision - latency to using unit again.
	33	Double precision - latency to consumer of result value.
	30	Double precision - latency to using unit again.
ftoi	3	—
itof	4	—
nop	—	Does not produce register value.

2.4 Instruction Retire Rules

An instruction is retired when it has been executed to completion, and all previous instructions have been retired. The execution pipeline stage in which an instruction becomes eligible to be retired depends upon the instruction’s class.

Table 2–5 gives the minimum retire latencies (assuming that all previous instructions have been retired) for various classes of instructions.

Table 2–5 Minimum Retire Latencies for Instruction Classes

Instruction Class	Retire Stage	Comments
Integer conditional branch	7	—
Integer multiply	7/13	Latency is 13 cycles for the MUL/V instruction.
Integer operate	7	—
Memory	10	—
Floating-point add	11	—
Floating-point multiply	11	—

Retire of Operate Instructions into R31/F31

Table 2–5 Minimum Retire Latencies for Instruction Classes (Continued)

Instruction Class	Retire Stage	Comments
Floating-point DIV/SQRT	11 + latency	Add latency of unit reuse for the instruction indicated in Table 2–4. For example, latency for a single-precision fdiv would be 11 plus 9 from Table 2–4. Latency is 11 if hardware detects that no exception is possible (see Section 2.4.1).
Floating-point conditional branch	11	Branch instruction mispredict is reported in stage 7.
BSR/JSR	10	JSR instruction mispredict is reported in stage 8.

2.4.1 Floating-Point Divide/Square Root Early Retire

The floating-point divider and square root unit can detect that, for many combinations of source operand values, no exception can be generated. Instructions with these operands can be retired before the result is generated. When detected, they are retired with the same latency as the FP add class. Early retirement is not possible for the following instruction/operand/architecture state conditions:

- Instruction is not a DIV or SQRT.
- SQRT source operand is negative.
- Divide operand exponent_a is 0.
- Either operand is NaN or INF.
- Divide operand exponent_b is 0.
- Trapping mode is /I (inexact).
- INE status bit is 0.

Early retirement is also not possible for divide instructions if the resulting exponent has any of the following characteristics (EXP is the result exponent):

- DIVT, DIVG: (EXP \geq 3FF₁₆) OR (EXP \leq 2₁₆)
- DIVS, DIVF: (EXP \geq 7F₁₆) OR (EXP \leq 382₁₆)

2.5 Retire of Operate Instructions into R31/F31

Many instructions that have R31 or F31 as their destination are retired immediately upon decode (stage 3). These instructions do not produce a result and are removed from the pipeline as well. They do not occupy a slot in the issue queues and do not occupy a functional unit. Table 2–6 lists these instructions and some of their characteristics. The instruction type in Table 2–6 is from Table C-6 in Appendix C of the *Alpha Architecture Handbook, Version 4*.

Table 2–6 Instructions Retired Without Execution

Instruction Type	Notes
INTA, INTL, INTM, INTS	All with R31 as destination.
FLTI, FLTL, FLTV	All with F31 as destination. MT_FPCR is not included because it has no destination—it is never removed from the pipeline.
LDQ_U	All with R31 as destination.
MISC	TRAPB and EXCB are always removed. Others are never removed.
FLTS	All (SQRT, ITOF) with F31 as destination.

2.6 Load Instructions to R31 and F31

This section describes how the 21264/EV68A processes software-directed prefetch transactions and load instructions with a destination of R31 and F31.

Prefetches allocate a MAF entry. How the MAF entry is allocated is what distinguishes the type of prefetch. A normal prefetch is equivalent to a normal load MAF (that is, a MAF entry that puts the block into the Dcache in a readable state). A prefetch with modify intent is equivalent to a normal store MAF (that is, a MAF entry that puts the block into the Dcache in a writeable state). A prefetch, evict next, is equivalent to a normal load MAF, with the additional behavior described in Section 2.6.3.

A prefetch is not performed if the prefetch hits in the Dcache (as if it were a normal load).

Load operations to R31 and F31 may generate exceptions. These exceptions must be dismissed by PALcode.

The following sections describe the operational prefetch behavior of these instructions.

2.6.1 Normal Prefetch: LDBU, LDF, LDG, LDL, LDT, LDWU, HW_LDL Instructions

The 21264/EV68A processes these instructions as normal cache line prefetches. If the load instruction hits the Dcache, the instruction is dismissed, otherwise the addressed cache block is allocated into the Dcache.

The HW_LDL instruction construct equates to the HW_LD instruction with the LEN field clear. See Table 6–3.

2.6.2 Prefetch with Modify Intent: LDS Instruction

The 21264/EV68A processes an LDS instruction, with F31 as the destination, as a prefetch with modify intent transaction (ReadBlkMod command). If the transaction hits a dirty Dcache block, the instruction is dismissed. Otherwise, the addressed cache block is allocated into the Dcache for write access, with its dirty and modified bits set.

Special Cases of Alpha Instruction Execution

2.6.3 Prefetch, Evict Next: LDQ and HW_LDQ Instructions

The 21264/EV68A processes this instruction like a normal prefetch transaction (Read-BlkSpec command), with one exception—if the load misses the Dcache, the addressed cache block is allocated into the Dcache, but the Dcache set allocation pointer is left pointing to this block. The next miss to the same Dcache line will evict the block. For example, this instruction might be used when software is reading an array that is known to fit in the offchip Bcache, but will not fit into the onchip Dcache. In this case, the instruction ensures that the hardware provides the desired prefetch function without displacing useful cache blocks stored in the other set within the Dcache.

The HW_LDQ instruction construct equates to the HW_LD instruction with the LEN field set. See Table 6–3.

2.7 Special Cases of Alpha Instruction Execution

This section describes the mechanisms that the 21264/EV68A uses to process irregular instructions in the Alpha instruction set, and cases in which the 21264/EV68A processes instructions in a non-intuitive way.

2.7.1 Load Hit Speculation

The latency of integer load instructions that hit in the Dcache is three cycles. Figure 2–9 shows the pipeline timing for these integer load instructions. In Figure 2–9:

Symbol	Meaning
Q	Issue queue
R	Register file read
E	Execute
D	Dcache access
B	Data bus active

Figure 2–9 Pipeline Timing for Integer Load Instructions

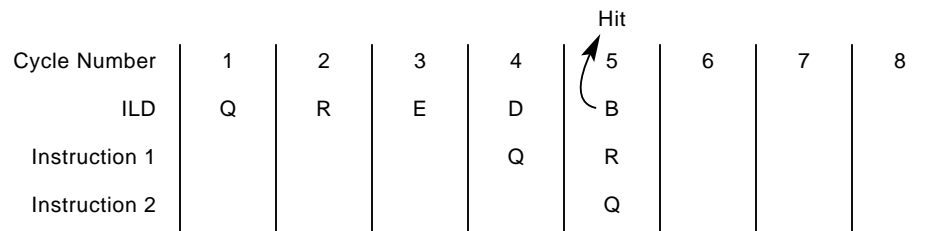

FM-05814.AI4

There are two cycles in which the IQ may speculatively issue instructions that use load data before Dcache hit information is known. Any instructions that are issued by the IQ within this 2-cycle speculative window are kept in the IQ with their requests inhibited until the load instruction's hit condition is known, even if they are not dependent on the load operation. If the load instruction hits, then these instructions are removed from the queue. If the load instruction misses, then the execution of these instructions is aborted and the instructions are allowed to request service again.

For example, in Figure 2–9, instruction 1 and instruction 2 are issued within the speculative window of the load instruction. If the load instruction hits, then both instructions will be deleted from the queue by the start of cycle 7—one cycle later than normal for instruction 1 and at the normal time for instruction 2. If the load instruction misses, both instructions are aborted from the execution pipelines and may request service again in cycle 6.

IQ-issued instructions are aborted if issued within the speculative window of an integer load instruction that missed in the Dcache, even if they are not dependent on the load data. However, if software misses are likely, the 21264/EV68A can still benefit from scheduling the instruction stream for Dcache miss latency. The 21264/EV68A includes a saturating counter that is incremented when load instructions hit and is decremented when load instructions miss. When the upper bit of the counter equals zero, the integer load latency is increased to five cycles and the speculative window is removed. The counter is 4 bits wide and is incremented by 1 on a hit and is decremented by two on a miss.

Since load instructions to R31 do not produce a result, they do not create a speculative window when they execute and, therefore, never waste IQ-issue cycles if they miss.

Floating-point load instructions that hit in the Dcache have a latency of four cycles. Figure 2–10 shows the pipeline timing for floating-point load instructions. In Figure 2–10:

Symbol	Meaning
Q	Issue queue
R	Register file read
E	Execute
D	Dcache access
B	Data bus active

Figure 2–10 Pipeline Timing for Floating-Point Load Instructions

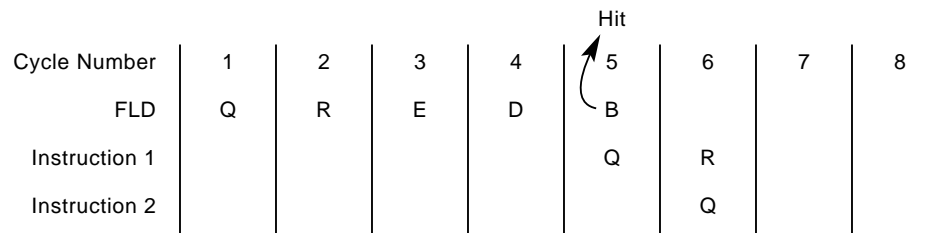

FM-05815.AI4

The speculative window for floating-point load instructions is one cycle wide. FQ-issued instructions that are issued within the speculative window of a floating-point load instruction that has missed, are only aborted if they depend on the load being successful.

For example, in Figure 2–10 instruction 1 is issued in the speculative window of the load instruction.

If instruction 1 is not a user of the data returned by the load instruction, then it is removed from the queue at its normal time (at the start of cycle 7).

Special Cases of Alpha Instruction Execution

If instruction 1 is dependent on the load instruction data and the load instruction hits, instruction 1 is removed from the queue one cycle later (at the start of cycle 8). If the load instruction misses, then instruction 1 is aborted from the Fbox pipeline and may request service again in cycle 7.

2.7.2 Floating-Point Store Instructions

Floating-point store instructions are duplicated and loaded into both the IQ and the FQ from the mapper. Each IQ entry contains a control bit, *fpWait*, that when set prevents that entry from asserting its requests. This bit is initially set for each floating-point store instruction that enters the IQ, unless it was the target of a replay trap. The instruction's FQ clone is issued when its Ra register is about to become clean, resulting in its IQ clone's *fpWait* bit being cleared and allowing the IQ clone to issue and be executed by the Mbox. This mechanism ensures that floating-point store instructions are always issued to the Mbox, along with the associated data, without requiring the floating-point register dirty bits to be available within the IQ.

2.7.3 CMOV Instruction

For the 21264/EV68A, the Alpha CMOV instruction has three operands, and so presents a special case. The required operation is to move either the value in register Rb or the value from the old physical destination register into the new destination register, based upon the value in Ra. Since neither the mapper nor the Ebox and Fbox data paths are otherwise required to handle three operand instructions, the CMOV instruction is decomposed by the Ibox pipeline into two 2-operand instructions:

The Alpha architecture instruction `CMOV Ra, Rb ⇒ Rc`
Becomes the 21264/EV68A instructions `CMOV1 Ra, oldRc ⇒ newRc1`
`CMOV2 newRc1, Rb ⇒ newRc2`

The first instruction, CMOV1, tests the value of Ra and records the result of this test in a 65th bit of its destination register, newRc1. It also copies the value of the old physical destination register, oldRc, to newRc1.

The second instruction, CMOV2, then copies either the value in newRc1 or the value in Rb into a second physical destination register, newRc2, based on the CMOV *predicate* bit stored in newRc1.

In summary, the original CMOV instruction is decomposed into two dependent instructions that each use a physical register from the free list.

To further simplify this operation, the two component instructions of a CMOV instruction are driven through the mappers in successive cycles. Hence, if a fetch line contains *n* CMOV instructions, it takes *n*+1 cycles to run that fetch line through the mappers.

For example, the following fetch line:

`ADD CMOVx SUB CMOVy`

Results in the following three map cycles:

```
ADD CMOVx1
CMOVx2 SUB CMOVy1
CMOVy2
```

The Ebox executes integer CMOV instructions as two distinct 1-cycle latency operations. The Fbox add pipeline executes floating-point CMOV instructions as two distinct 4-cycle latency operations.

2.8 Memory and I/O Address Space Instructions

This section provides an overview of the way the 21264/EV68A processes memory and I/O address space instructions.

The 21264/EV68A supports, and internally recognizes, a 44-bit physical address space that is divided equally between memory address space and I/O address space. Memory address space resides in the lower half of the physical address space (PA[43]=0) and I/O address space resides in the upper half of the physical address space (PA[43]=1).

The IQ can issue any combination of load and store instructions to the Mbox at the rate of two per cycle. The two lower Ebox subclusters, L0 and L1, generate the 48-bit effective virtual address for these instructions.

An instruction is defined to be *newer* than another instruction if it follows that instruction in program order and is *older* if it precedes that instruction in program order.

2.8.1 Memory Address Space Load Instructions

The Mbox begins execution of a load instruction by translating its virtual address to a physical address using the DTB and by accessing the Dcache. The Dcache is virtually indexed, allowing these two operations to be done in parallel. The Mbox puts information about the load instruction, including its physical address, destination register, and data format, into the LQ.

If the requested physical location is found in the Dcache (a hit), the data is formatted and written into the appropriate integer or floating-point register. If the location is not in the Dcache (a miss), the physical address is placed in the miss address file (MAF) for processing by the Cbox. The MAF performs a merging function in which a new miss address is compared to miss addresses already held in the MAF. If the new miss address points to the same Dcache block as a miss address in the MAF, then the new miss address is discarded.

When Dcache fill data is returned to the Dcache by the Cbox, the Mbox satisfies the requesting load instructions in the LQ.

2.8.2 I/O Address Space Load Instructions

Because I/O space load instructions may have side effects, they cannot be performed speculatively. When the Mbox receives an I/O space load instruction, the Mbox places the load instruction in the LQ, where it is held until it retires. The Mbox replays retired I/O space load instructions from the LQ to the MAF in program order, at a rate of one per GCLK cycle.

Memory and I/O Address Space Instructions

The Mbox allocates a new MAF entry to an I/O load instruction and increases I/O bandwidth by attempting to merge I/O load instructions in a merge register. Table 2–7 shows the rules for merging data. The columns represent the load instructions replayed to the MAF while the rows represent the size of the load in the merge register.

Table 2–7 Rules for I/O Address Space Load Instruction Data Merging

Merge Register/ Replayed Instruction	Load Byte/Word	Load Longword	Load Quadword
Byte/Word	No merge	No merge	No merge
Longword	No merge	Merge up to 32 bytes	No merge
Quadword	No merge	No merge	Merge up to 64 bytes

In summary, Table 2–7 shows some of the following rules:

- Byte/word load instructions and different size load instructions are not allowed to merge.
- A stream of ascending non-overlapping, but not necessarily consecutive, longword load instructions are allowed to merge into naturally aligned 32-byte blocks.
- A stream of ascending non-overlapping, but not necessarily consecutive, quadword load instructions are allowed to merge into naturally aligned 64-byte blocks.
- Merging of quadwords can be limited to naturally-aligned 32-byte blocks based on the Cbox WRITE_ONCE chain 32_BYTE_IO field.
- Issued MB, WMB, and I/O load instructions close the I/O register merge window. To minimize latency, the merge window is also closed when a timer detects no I/O store instruction activity for 1024 cycles.

After the Mbox I/O register has closed its merge window, the Cbox sends I/O read requests offchip in the order that they were received from the Mbox.

2.8.3 Memory Address Space Store Instructions

The Mbox begins execution of a store instruction by translating its virtual address to a physical address using the DTB and by probing the Dcache. The Mbox puts information about the store instruction, including its physical address, its data and the results of the Dcache probe, into the store queue (SQ).

If the Mbox does not find the addressed location in the Dcache, it places the address into the MAF for processing by the Cbox. If the Mbox finds the addressed location in a Dcache block that is not dirty, then it places a ChangeToDirty request into the MAF.

A store instruction can write its data into the Dcache when it is retired, and when the Dcache block containing its address is dirty and not shared. SQ entries that meet these two conditions can be placed into the *writable* state. These SQ entries are placed into the *writable* state in program order at a maximum rate of two entries per cycle. The Mbox transfers *writable* store queue entry data from the SQ to the Dcache in program order at a maximum rate of two entries per cycle. Dcache lines associated with *writable* store queue entries are locked by the Mbox. System port probe commands cannot evict these blocks until their associated writable SQ entries have been transferred into the Dcache. This restriction assists in STx_C instruction and Dcache ECC processing.

SQ entry data that has not been transferred to the Dcache may source data to newer load instructions. The Mbox compares the virtual Dcache index bits of incoming load instructions to queued SQ entries, and sources the data from the SQ, bypassing the Dcache, when necessary.

2.8.4 I/O Address Space Store Instructions

The Mbox begins processing I/O space store instructions, like memory space store instructions, by translating the virtual address and placing the state associated with the store instruction into the SQ.

The Mbox replays retired I/O space store entries from the SQ to the IOWB in program order at a rate of one per GCLK cycle. The Mbox never allows queued I/O space store instructions to source data to subsequent load instructions.

The Cbox maximizes I/O bandwidth when it allocates a new IOWB entry to an I/O store instruction by attempting to merge I/O store instructions in a merge register. Table 2–8 shows the rules for I/O space store instruction data merging. The columns represent the load instructions replayed to the IOWB while the rows represent the size of the store in the merge register.

Table 2–8 Rules for I/O Address Space Store Instruction Data Merging

Merge Register/ Replayed Instruction	Store Byte/Word	Store Longword	Store Quadword
Byte/Word	No merge	No merge	No merge
Longword	No merge	Merge up to 32 bytes	No merge
Quadword	No merge	No merge	Merge up to 64 bytes

Table 2–8 shows some of the following rules:

- Byte/word store instructions and different size store instructions are not allowed to merge.
- A stream of ascending non-overlapping, but not necessarily consecutive, longword store instructions are allowed to merge into naturally aligned 32-byte blocks.
- A stream of ascending non-overlapping, but not necessarily consecutive, quadword store instructions are allowed to merge into naturally aligned 64-byte blocks.
- Merging of quadwords can be limited to naturally-aligned 32-byte blocks based on the Cbox WRITE_ONCE chain 32_BYTE_IO field.
- Issued MB, WMB, and I/O load instructions close the I/O register merge window. To minimize latency, the merge window is also closed when a timer detects no I/O store instruction activity for 1024 cycles.

After the IOWB merge register has closed its merge window, the Cbox sends I/O space store requests offchip in the order that they were received from the Mbox.

2.9 MAF Memory Address Space Merging Rules

Because all memory transactions are to 64-byte blocks, efficiency is improved by merging several small data transactions into a single larger data transaction. Table 2–9 lists the rules the 21264/EV68A uses when merging memory transactions into 64-byte naturally aligned data block transactions. Rows represent the merged instruction in the MAF and columns represent the new issued transaction.

Table 2–9 MAF Merging Rules

MAF/New	LDx	STx	STx_C	WH64	ECB	Istream
LDx	Merge	—	—	—	—	—
STx	Merge	Merge	—	—	—	—
STx_C	—	—	Merge	—	—	—
WH64	—	—	—	Merge	—	—
ECB	—	—	—	—	Merge	—
Istream	—	—	—	—	—	Merge

In summary, Table 2–9 shows that only like instruction types, with the exception of load instructions merging with store instructions, are merged.

2.10 Instruction Ordering

In the absence of explicit instruction ordering, such as with MB or WMB instructions, the 21264/EV68A maintains a default instruction ordering relationship between pairs of load and store instructions.

The 21264/EV68A maintains the default memory data instruction ordering as shown in Table 2–10 (assume address X and address Y are different).

Table 2–10 Memory Reference Ordering

First Instruction in Pair	Second Instruction in Pair	Reference Order
Load memory to address X	Load memory to address X	Maintained (litmus test 1)
Load memory to address X	Load memory to address Y	Not maintained
Store memory to address X	Store memory to address X	Maintained
Store memory to address X	Store memory to address Y	Maintained
Load memory to address X	Store memory to address X	Maintained
Load memory to address X	Store memory to address Y	Not maintained
Store memory to address X	Load memory to address X	Maintained
Store memory to address X	Load memory to address Y	Not maintained

The 21264/EV68A maintains the default I/O instruction ordering as shown in Table 2–11 (assume address X and address Y are different).

Table 2–11 I/O Reference Ordering

First Instruction in Pair	Second Instruction in Pair	Reference Order
Load I/O to address X	Load I/O to address X	Maintained
Load I/O to address X	Load I/O to address Y	Maintained
Store I/O to address X	Store I/O to address X	Maintained
Store I/O to address X	Store I/O to address Y	Maintained
Load I/O to address X	Store I/O to address X	Maintained
Load I/O to address X	Store I/O to address Y	Not maintained
Store I/O to address X	Load I/O to address X	Maintained
Store I/O to address X	Load I/O to address Y	Not maintained

2.11 Replay Traps

There are some situations in which a load or store instruction cannot be executed due to a condition that occurs after that instruction issues from the IQ or FQ. The instruction is aborted (along with all newer instructions) and restarted from the fetch stage of the pipeline. This mechanism is called a replay trap.

2.11.1 Mbox Order Traps

Load and store instructions may be issued from the IQ in a different order than they were fetched from the Icache, while the architecture dictates that Dstream memory transactions to the same physical bytes must be completed in order. Usually, the Mbox manages the memory reference stream by itself to achieve architecturally correct behavior, but the two cases in which the Mbox uses replay traps to manage the memory stream are *load-load* and *store-load* order traps.

2.11.1.1 Load-Load Order Trap

The Mbox ensures that load instructions that read the same physical byte(s) ultimately issue in correct order by using the *load-load* order trap. The Mbox compares the address of each load instruction, as it is issued, to the address of all load instructions in the load queue. If the Mbox finds a newer load instruction in the load queue, it invokes a *load-load* order trap on the newer instruction. This is a replay trap that aborts the target of the trap and all newer instructions from the machine and refetches instructions starting at the target of the trap.

2.11.1.2 Store-Load Order Trap

The Mbox ensures that a load instruction ultimately issues after an older store instruction that writes some portion of its memory operand by using the *store-load* order trap. The Mbox compares the address of each store instruction, as it is issued, to the address of all load instructions in the load queue. If the Mbox finds a newer load instruction in the load queue, it invokes a *store-load* order trap on the load instruction. This is a replay trap. It functions like the *load-load* order trap.

I/O Write Buffer and the WMB Instruction

The Ibox contains extra hardware to reduce the frequency of the *store-load* trap. There is a 1-bit by 1024-entry VPC-indexed table in the Ibox called the stWait table. When an Icache instruction is fetched, the associated stWait table entry is fetched along with the Icache instruction. The stWait table produces 1 bit for each instruction accessed from the Icache. When a load instruction gets a *store-load* order replay trap, its associated bit in the stWait table is set during the cycle that the load is refetched. Hence, the trapping load instruction's stWait bit will be set the next time it is fetched.

The IQ will not issue load instructions whose stWait bit is set while there are older unissued store instructions in the queue. A load instruction whose stWait bit is set can be issued the cycle immediately after the last older store instruction is issued from the queue. All the bits in the stWait table are unconditionally cleared every 16384 cycles, or every 65536 cycles if I_CTL[ST_WAIT_64K] is set.

2.11.2 Other Mbox Replay Traps

The Mbox also uses replay traps to control the flow of the load queue and store queue, and to ensure that there are never multiple outstanding misses to different physical addresses that map to the same Dcache or Bcache line. Unlike the order traps, however, these replay traps are invoked on the incoming instruction that triggered the condition.

2.12 I/O Write Buffer and the WMB Instruction

The I/O write buffer (IOWB) consists of four 64-byte entries with the associated address and control logic used to buffer I/O write data between the store queue (SQ) and the system port.

2.12.1 Memory Barrier (MB/WMB/TB Fill Flow)

The Cbox CSR SYSBUS_MB_ENABLE bit determines if MB instructions produce external system port transactions. When the SYSBUS_MB_ENABLE bit equals 0, the Cbox CSR MB_CNT[3:0] field contains the number of pending uncommitted transactions. The counter will increment for each of the following commands:

- RdBlk, RdBlkMod, RdBlkI
- RdBlkSpec (valid), RdBlkModSpec (valid), RdBlkSpecI (valid)
- RdBlkVic, RdBlkModVic, RdBlkVicI
- CleanToDirty, SharedToDirty, STChangeToDirty, InvalToDirty
- FetchBlk, FetchBlkSpec (valid), Evict
- RdByte, RdLw, RdQw, WrByte, WrLW, WrQW

The counter is decremented with the C (commit) bit in the Probe and SysDc commands (see Section 4.7.7). Systems can assert the C bit in the SysDc fill response to the commands that originally incremented the counter, or attached to the last probe seen by that command when it reached the system serialization point. If the number of uncommitted transactions reaches 15 (saturating the counter), the Cbox will stall MAF and IOWB processing until at least one of the pending transactions has been committed. Probe processing is not interrupted by the state of this counter.

2.12.1.1 MB Instruction Processing

When an MB instruction is fetched in the predicted instruction execution path, it stalls in the map stage of the pipeline. This also stalls all instructions after the MB, and control of instruction flow is based upon the value in Cbox CSR SYSBUS_MB_ENABLE as follows:

- If Cbox CSR SYSBUS_MB_ENABLE is clear, the Cbox waits until the IQ is empty and then performs the following actions:
 - a. Sends all pending MAF and IOWB entries to the system port.
 - b. Monitors Cbox CSR MB_CNT[3:0], a 4-bit counter of outstanding committed events. When the counter decrements from one to zero, the Cbox marks the youngest probe queue entry.
 - c. Waits until the MAF contains no more Dstream references and the SQ, LQ, and IOWB are empty.

When all of the above have occurred and a probe response has been sent to the system for the marked probe queue entry, instruction execution continues with the instruction after the MB.

- If Cbox CSR SYSBUS_MB_ENABLE is set, the Cbox waits until the IQ is empty and then performs the following actions:
 - a. Sends all pending MAF and IOWB entries to the system port
 - b. Sends the MB command to the system port
 - c. Waits until the MB command is acknowledged, then marks the youngest entry in the probe queue
 - d. Waits until the MAF contains no more Dstream references and the SQ, LQ, and IOWB are empty

When all of the above have occurred and a probe response has been sent to the system for the marked probe queue entry, instruction execution continues with the instruction after the MB.

Because the MB instruction is executed speculatively, MB processing can begin and the original MB can be killed. In the internal acknowledge case, the MB may have already been sent to the system interface, and the system is still expected to respond to the MB.

2.12.1.2 WMB Instruction Processing

Write memory barrier (WMB) instructions are issued into the Mbox store-queue, where they wait until they are retired and all prior store instructions become writable. The Mbox then stalls the writable pointer and informs the Cbox. The Cbox closes the IOWB merge register and responds in one of the following two ways:

- If Cbox CSR SYSBUS_MB_ENABLE is clear, the Cbox performs the following actions:
 - a. Stalls further MAF and IOWB processing.
 - b. Monitors Cbox CSR MB_CNT[3:0], a 4-bit counter of outstanding committed events. When the counter decrements from one to zero, the Cbox marks the youngest probe queue entry.

I/O Write Buffer and the WMB Instruction

- c. When a probe response has been sent to the system for the marked probe queue entry, the Cbox considers the WMB to be satisfied.
- If Cbox CSR SYSBUS_MB_ENABLE is set, the Cbox performs the following actions:
 - a. Stalls further MAF and IOWB processing.
 - b. Sends the MB command to the system port.
 - c. Waits until the MB command is acknowledged by the system with a SysDc MBDone command, then sends acknowledge and marks the youngest entry in the probe queue.
 - d. When a probe response has been sent to the system for the marked probe queue entry, the Cbox considers the WMB to be satisfied.

2.12.1.3 TB Fill Flow

Load instructions (HW_LDs) to a virtual page table entry (VPTE) are processed by the 21264/EV68A to avoid litmus test problems associated with the ordering of memory transactions from another processor against loading of a page table entry and the subsequent virtual-mode load from this processor.

Consider the sequence shown in Table 2–12. The data could be in the Bcache. Pj should fetch datai if it is using PTEi.

Table 2–12 TB Fill Flow Example Sequence 1

Pi	Pj
Write Datai	Load/Store datai
MB	<TB miss>
Write PTEi	Load-PTE <write TB> Load/Store (restart)

Also consider the related sequence shown in Table 2–13. In this case, the data could be cached in the Bcache; Pj should fetch datai if it is using PTEi.

Table 2–13 TB Fill Flow Example Sequence 2

Pi	Pj
Write Datai	Istream read datai
MB	<TB miss>
Write PTEi	Load-PTE <write TB> Istream read (restart) - will miss the Icache

The 21264/EV68A processes Dstream loads to the PTE by injecting, in hardware, some memory barrier processing between the PTE transaction and any subsequent load or store instruction. This is accomplished by the following mechanism:

1. The integer queue issues a HW_LD instruction with VPTE.

2. The integer queue issues a HW_MTPR instruction with a DTB_PTE0, that is data-dependent on the HW_LD instruction with a VPTE, and is required in order to fill the DTBs. The HW_MTPR instruction, when queued, sets IPR scoreboard bits [4] and [0].
3. When a HW_MTPR instruction with a DTB_PTE0 is issued, the Ibox signals the Cbox indicating that a HW_LD instruction with a VPTE has been processed. This causes the Cbox to begin processing the MB instruction. The Ibox prevents any subsequent memory operations being issued by not clearing the IPR scoreboard bit [0]. IPR scoreboard bit [0] is one of the scoreboard bits associated with the HW_MTPR instruction with DTB_PTE0.
4. When the Cbox completes processing the MB instruction (using one of the above sequences, depending upon the state of SYSBUS_MB_ENABLE), the Cbox signals the Ibox to clear IPR scoreboard bit [0].

The 21264/EV68A uses a similar mechanism to process Istream TB misses and fills to the PTE for the Istream.

1. The integer queue issues a HW_LD instruction with VPTE.
2. The IQ issues a HW_MTPR instruction with an ITB_PTE that is data-dependent upon the HW_LD instruction with VPTE. This is required in order to fill the ITB. The HW_MTPR instruction, when queued, sets IPR scoreboard bits [4] and [0].
3. The Cbox issues a HW_MTPR instruction for the ITB_PTE and signals the Ibox that a HW_LD/VPTE instruction has been processed, causing the Cbox to start processing the MB instruction. The Mbox stalls Ibox fetching from when the HW_LD/VPTE instruction finishes until the probe queue is drained.
4. When the 21264/EV68A is finished (SYS_MB selects one of the above sequences), the Cbox directs the Ibox to clear IPR scoreboard bit [0]. Also, the Mbox directs the Ibox to start prefetching.

Inserting MB instruction processing within the TB fill flow is only required for multiprocessor systems. Uniprocessor systems can disable MB instruction processing by deasserting Ibox CSR I_CTL[TB_MB_EN].

2.13 Performance Measurement Support—Performance Counters

The 21264/EV68A provides hardware support for two methods of obtaining program performance feedback information. The two methods do not require program modification. The first method offers similar capabilities to earlier microprocessor performance counters. The second method supports the new ProfileMe way of statistically sampling individual instructions during program execution to develop a model of program execution. Both methods use the same hardware registers.

See Section 6.10 for information about counter control.

2.14 Floating-Point Control Register

The floating-point control register (FPCR) is shown in Figure 2–11.

Floating-Point Control Register

Figure 2–11 Floating-Point Control Register

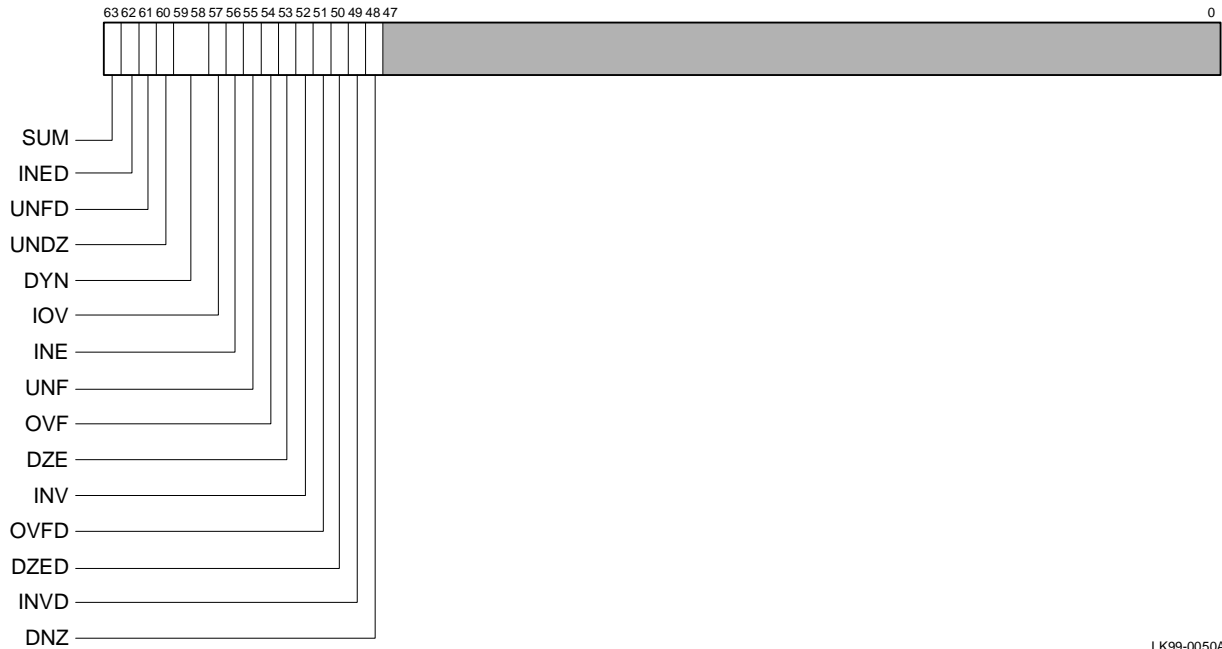

LK99-0050A

The floating-point control register fields are described in Table 2–14.

Table 2–14 Floating-Point Control Register Fields

Name	Extent	Type	Description												
SUM	[63]	RW	Summary bit. Records bit-wise OR of FPCR exception bits. The summary bit is not directly modified by writes to bit 63 of the FPCR, but is indirectly modified by changes to FPCR bits 57–52.												
INED	[62]	RW	Inexact Disable. If this bit is set and a floating-point instruction that enables trapping on inexact results generates an inexact value, the result is placed in the destination register and the trap is suppressed.												
UNFD	[61]	RW	Underflow Disable. The 21264/EV68A hardware cannot generate IEEE compliant denormal results. UNFD is used in conjunction with UNDZ as follows: <table border="1" style="margin-left: 20px;"> <thead> <tr> <th>UNFD</th> <th>UNDZ</th> <th>Result</th> </tr> </thead> <tbody> <tr> <td>0</td> <td>X</td> <td>Underflow trap.</td> </tr> <tr> <td>1</td> <td>0</td> <td>Trap to supply a possible denormal result.</td> </tr> <tr> <td>1</td> <td>1</td> <td>Underflow trap suppressed. Destination is written with a true zero (+0.0).</td> </tr> </tbody> </table>	UNFD	UNDZ	Result	0	X	Underflow trap.	1	0	Trap to supply a possible denormal result.	1	1	Underflow trap suppressed. Destination is written with a true zero (+0.0).
UNFD	UNDZ	Result													
0	X	Underflow trap.													
1	0	Trap to supply a possible denormal result.													
1	1	Underflow trap suppressed. Destination is written with a true zero (+0.0).													
UNDZ	[60]	RW	Underflow to zero. When UNDZ is set together with UNFD, underflow traps are disabled and the 21264/EV68A places a true zero in the destination register. See UNFD, above.												

Table 2–14 Floating-Point Control Register Fields (Continued)

Name	Extent	Type	Description										
DYN	[59:58]	RW	Dynamic rounding mode. Indicates the rounding mode to be used by an IEEE floating-point instruction when the instruction specifies dynamic rounding mode: <table border="1" style="margin-left: 20px;"> <thead> <tr> <th>Bits</th> <th>Meaning</th> </tr> </thead> <tbody> <tr> <td>00</td> <td>Chopped</td> </tr> <tr> <td>01</td> <td>Minus infinity</td> </tr> <tr> <td>10</td> <td>Normal</td> </tr> <tr> <td>11</td> <td>Plus infinity</td> </tr> </tbody> </table>	Bits	Meaning	00	Chopped	01	Minus infinity	10	Normal	11	Plus infinity
Bits	Meaning												
00	Chopped												
01	Minus infinity												
10	Normal												
11	Plus infinity												
IOV	[57]	RW	Integer overflow. A CVTGQ, CVTTQ, or CVTQL overflowed the destination precision.										
INE	[56]	RW	Inexact result. A floating-point arithmetic or conversion operation gave a result that differed from the mathematically exact result.										
UNF	[55]	RW	Underflow. A floating-point arithmetic or conversion operation gave a result that underflowed the destination exponent.										
OVF	[54]	RW	Overflow. A floating-point arithmetic or conversion operation gave a result that overflowed the destination exponent.										
DZE	[53]	RW	Divide by zero. An attempt was made to perform a floating-point divide with a divisor of zero.										
INV	[52]	RW	Invalid operation. An attempt was made to perform a floating-point arithmetic operation and one or more of its operand values were illegal.										
OVFD	[51]	RW	Overflow disable. If this bit is set and a floating-point arithmetic operation generates an overflow condition, then the appropriate IEEE nontrapping result is placed in the destination register and the trap is suppressed.										
DZED	[50]	RW	Division by zero disable. If this bit is set and a floating-point divide by zero is detected, the appropriate IEEE nontrapping result is placed in the destination register and the trap is suppressed.										
INVD	[49]	RW	Invalid operation disable. If this bit is set and a floating-point operate generates an invalid operation condition and 21264/EV68A is capable of producing the correct IEEE nontrapping result, that result is placed in the destination register and the trap is suppressed.										
DNZ	[48]	RW	Denormal operands to zero. If this bit is set, treat all Denormal operands as a signed zero value with the same sign as the Denormal operand.										
Reserved	[47:0] ¹	—	—										

¹ Alpha architecture FPCR bit 47 (DNOD) is not implemented by the 21264/EV68A.

2.15 AMASK and IMPLVER Instruction Values

The AMASK and IMPLVER instructions return the supported architecture extensions and processor type, respectively.

2.15.1 AMASK

The 21264/EV68A returns the AMASK instruction values provided in Table 2–15. The I_CTL register reports the 21264/EV68A pass level (see I_CTL[CHIP_ID], Section 5.2.15).

Table 2–15 21264/EV68A AMASK Values

21264/EV68A Pass Level	AMASK Feature Mask Value
See I_CTL[CHIP_ID], Table 5–11	1307 ₁₆

The AMASK bit definitions provided in Table 2–15 are defined in Table 2–16.

Table 2–16 AMASK Bit Assignments

Bit	Meaning
0	Support for the byte/word extension (BWX) The instructions that comprise the BWX extension are LDBU, LDWU, SEXTB, SEXTW, STB, and STW.
1	Support for the square-root and floating-point convert extension (FIX) The instructions that comprise the FIX extension are FTOIS, FTOIT, ITOFF, ITOFS, ITOFT, SQRTF, SQRTG, SQRTS, and SQRTT.
2	Support for the count extension (CIX) The instructions that comprise the CIX extension are CTLZ, CTPOP, and CTTZ.
8	Support for the multimedia extension (MVI) The instructions that comprise the MVI extension are MAXSB8, MAXSW4, MAXUB8, MAXUW4, MINSB8, MINSW4, MINUB8, MINUW4, PERR, PKLB, PKWB, UNPKBL, and UNPKBW.
9	Support for precise arithmetic trap reporting in hardware. The trap PC is the same as the instruction PC after the trapping instruction is executed.
12	Support for using a prefetch with modify intent to improve the performance of the first attempt to acquire a lock. When clear, indicates possible prefetch error with locks, described in waiver 10 to the Alpha Architecture and in the prefetch section of the appropriate processor (21264/EV6 and 21264/EV67) documents.

2.15.2 IMPLVER

For the 21264/EV68A, the IMPLVER instruction returns the value 2.

2.16 Design Examples

The 21264/EV68A can be designed into many different uniprocessor and multiprocessor system configurations. Figures 2–12 and 2–13 illustrate two possible configurations. These configurations employ additional system/memory controller chipsets.

Figure 2–12 shows a typical uniprocessor system with a second-level cache. This system configuration could be used in standalone or networked workstations.

Figure 2–12 Typical Uniprocessor Configuration

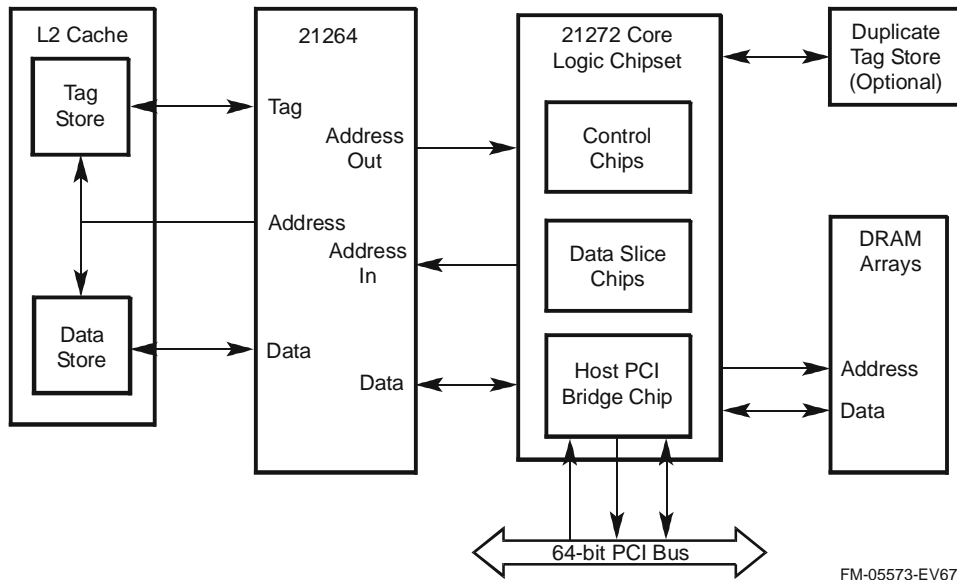

FM-05573-EV67

Figure 2–13 shows a typical multiprocessor system, each processor with a second-level cache. Each interface controller must employ a duplicate tag store to maintain cache coherency. This system configuration could be used in a networked database server application.

Figure 2–13 Typical Multiprocessor Configuration

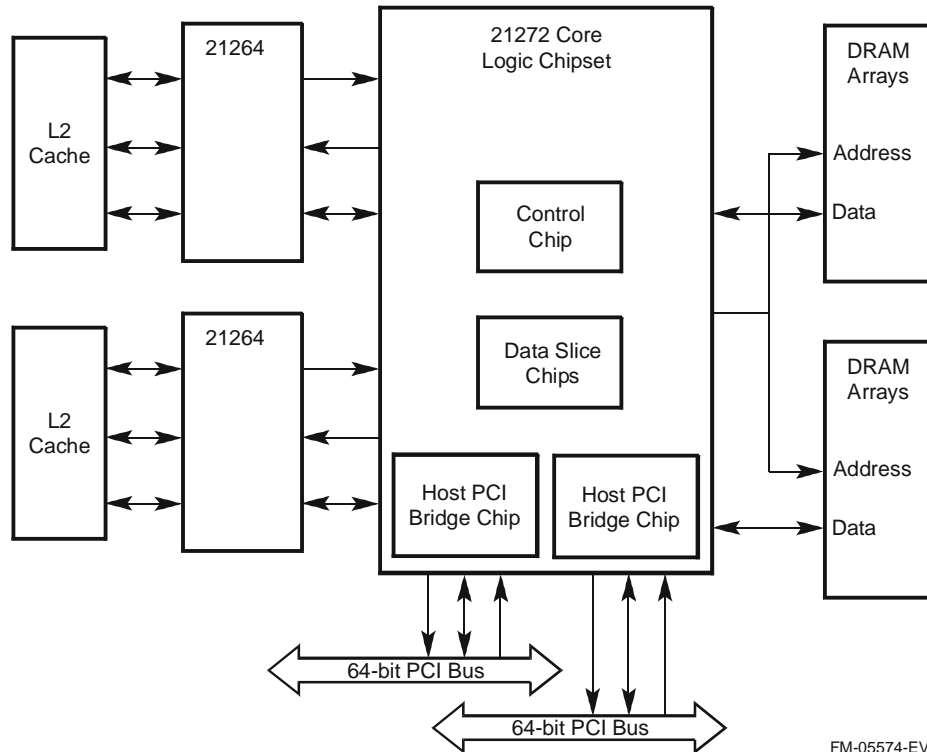

FM-05574-EV67

This chapter contains the 21264/EV68A microprocessor logic symbol and provides information about signal names, their function, and their location. This chapter also describes the mechanical specifications of the 21264/EV68A. It is organized as follows:

- The 21264/EV68A logic symbol
- The 21264/EV68A signal names and functions
- Lists of the signal pins, sorted by name and PGA location
- The specifications for the 21264/EV68A mechanical package
- The top and bottom views of the 21264/EV68A pinouts

3.1 21264/EV68A Microprocessor Logic Symbol

Figure 3–1 show the logic symbol for the 21264/EV68A chip.

21264/EV68A Microprocessor Logic Symbol

Figure 3–1 21264/EV68A Microprocessor Logic Symbol

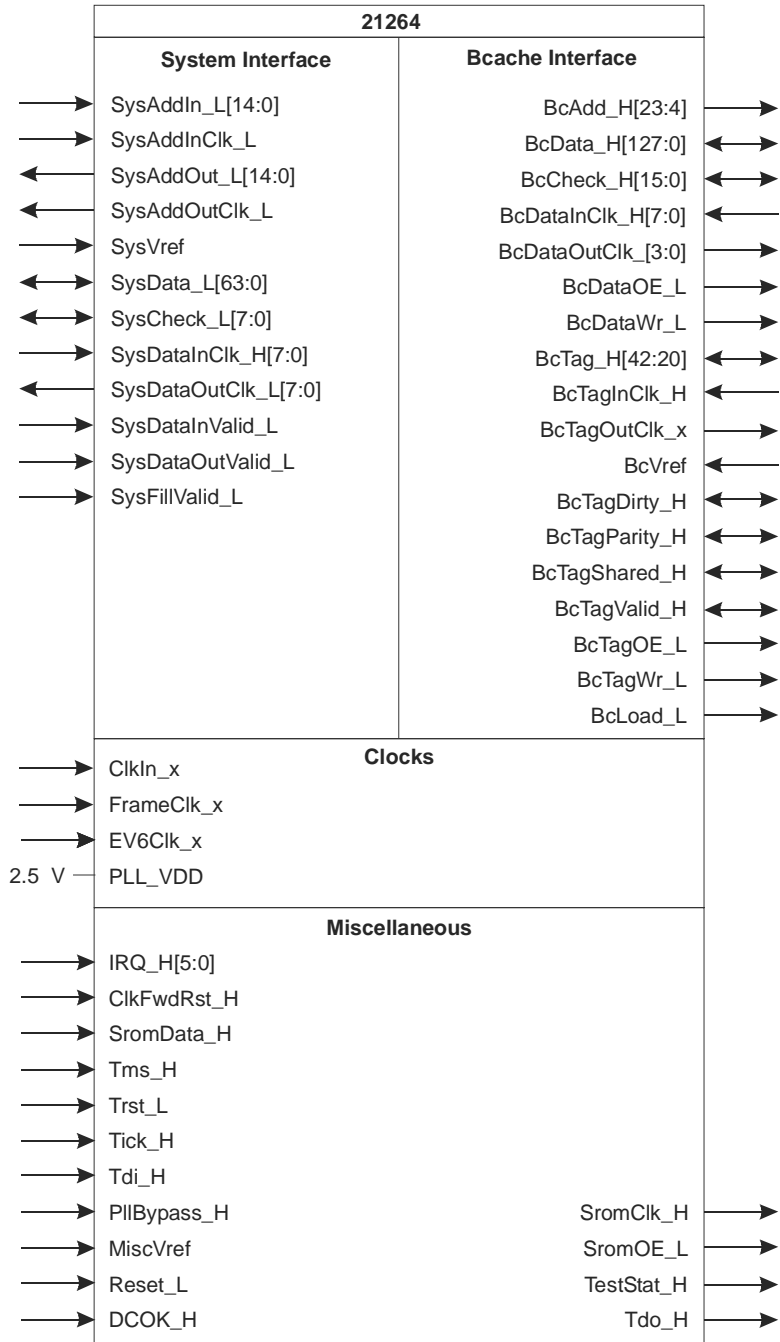

FM-05646b

3.2 21264/EV68A Signal Names and Functions

Table 3–1 defines the 21264/EV68A signal types referred to in this section.

Table 3–1 Signal Pin Types Definitions

Signal Type	Definition
Inputs	
I_DC_REF	Input DC reference pin
I_DA	Input differential amplifier receiver
I_DA_CLK	Input clock pin
Outputs	
O_OD	Open drain output driver
O_OD_TP	Open drain driver for test pins
O_PP	Push/pull output driver
O_PP_CLK	Push/pull output clock driver
Bidirectional	
B_DA_OD	Bidirectional differential amplifier receiver with open drain output
B_DA_PP	Bidirectional differential amplifier receiver with push/pull output
Other	
Spare	Reserved to COMPAQ ¹
NoConnect	No connection — Do not connect to these pins for any revision of the 21264/EV68A. These pins must float.

¹ All Spare connections are Reserved to COMPAQ to maintain compatibility between passes of the chip. Designers should not use these pins.

Table 3–2 lists all signal pins in alphabetic order and provides a full functional description of the pins. Table 3–4 lists the signal pins and their corresponding pin grid array (PGA) locations in alphabetic order for the signal type. Table 3–5 lists the pin grid array locations in alphabetical order.

Table 3–2 21264/EV68A Signal Descriptions

Signal	Type	Count	Description
BcAdd_H[23:4]	O_PP	20	These signals provide the index to the Bcache.
BcCheck_H[15:0]	B_DA_PP	16	ECC check bits for BcData_H[127:0] .
BcData_H[127:0]	B_DA_PP	128	Bcache data signals.
BcDataInClk_H[7:0]	I_DA	8	Bcache data input clocks. These clocks are used with high speed SDRAMs, such as DDRs, that provide a clock-out with data-output pins to optimize Bcache read bandwidths. The 21264/EV68A internally synchronizes the data to its logic with clock forward receive circuits similar to the system interface.
BcDataOE_L	O_PP	1	Bcache data output enable. The 21264/EV68A asserts this signal during Bcache read operations.

Table 3–2 21264/EV68A Signal Descriptions (Continued)

Signal	Type	Count	Description
BcDataOutClk_H[3:0] BcDataOutClk_L[3:0]	O_PP	8	Bcache data output clocks. These free-running clocks are differential copies of the Bcache clock and are derived from the 21264/EV68A GCLK. Their period is a multiple of the GCLK and is fixed for all operations. They can be configured so that their rising edge lags BcAdd_H[23:4] by 0 to 2 GCLK cycles. The 21264/EV68A synchronizes tag output information with these clocks.
BcDataWr_L	O_PP	1	Bcache data write enable. The 21264/EV68A asserts this signal when writing data to the Bcache data arrays.
BcLoad_L	O_PP	1	Bcache burst enable.
BcTag_H[42:20]	B_DA_PP	23	Bcache tag bits.
BcTagDirty_H	B_DA_PP	1	Tag dirty state bit. During cache write operations, the 21264/EV68A will assert this signal if the Bcache data has been modified.
BcTagInClk_H	I_DA	1	Bcache tag input clock. The 21264/EV68A uses this input clock to latch the tag information on Bcache read operations. This clock is used with high-speed SDRAMs, such as DDRs, that provide a clock-out with data-output pins to optimize Bcache read bandwidths. The 21264/EV68A internally synchronizes the data to its logic with clock forward receive circuits similar to the system interface.
BcTagOE_L	O_PP	1	Bcache tag output enable. This signal is asserted by the 21264/EV68A for Bcache read operations.
BcTagOutClk_H BcTagOutClk_L	O_PP	2	Bcache tag output clock. These clocks “echo” the clock-forwarded BcDataOutClk_x[3:0] clocks.
BcTagParity_H	B_DA_PP	1	Tag parity state bit.
BcTagShared_H	B_DA_PP	1	Tag shared state bit. The 21264/EV68A will write a 1 on this signal line if another agent has a copy of the cache line.
BcTagValid_H	B_DA_PP	1	Tag valid state bit. If set, this line indicates that the cache line is valid.
BcTagWr_L	O_PP	1	Tag RAM write enable. The 21264/EV68A asserts this signal when writing a tag to the Bcache tag arrays.
BcVref	I_DC_REF	1	Bcache tag reference voltage.
ClkFwdRst_H	I_DA	1	Systems assert this synchronous signal to wake up a powered-down 21264/EV68A. The ClkFwdRst_H signal is clocked into a 21264/EV68A register by the captured FrameClk_x signals. Systems must ensure that the timing of this signal meets 21264/EV68A requirements (see Section 4.7.2).
ClkIn_H ClkIn_L	I_DA_CLK	2	Differential input signals provided by the system.
DCOK_H	I_DA	1	dc voltage OK. Must be deasserted until dc voltage reaches proper operating level. After that, DCOK_H is asserted.
EV6Clk_H EV6Clk_L	O_PP_CLK	2	Provides an external test point to measure phase alignment of the PLL.

Table 3–2 21264/EV68A Signal Descriptions (Continued)

Signal	Type	Count	Description
FrameClk_H FrameClk_L	I_DA_CLK	2	A skew-controlled differential 50% duty cycle copy of the system clock. It is used by the 21264/EV68A as a reference, or framing, clock.
IRQ_H[5:0]	I_DA	6	These six interrupt signal lines may be asserted by the system. The response of the 21264/EV68A is determined by the system software.
MiscVref	I_DC_REF	1	Voltage reference for the miscellaneous pins (see Table 3–3).
PlIBypass_H	I_DA	1	When asserted, this signal will cause the two input clocks (ClkIn_x) to be applied to the 21264/EV68A internal circuits, instead of the 21264/EV68A global clock (GCLK).
PLL_VDD	2.5 V	1	2.5-V dedicated power supply for the 21264/EV68A PLL.
Reset_L	I_DA	1	System reset. This signal protects the 21264/EV68A from damage during initial power-up. It must be asserted until DCOK_H is asserted. After that, it is deasserted and the 21264/EV68A begins its reset sequence.
SromClk_H	O_OD_TP	1	Serial ROM clock. Supplies the clock that causes the SROM to advance to the next bit. The cycle time for this clock is 256 times the cycle time of the GCLK (internal 21264/EV68A clock).
SromData_H	I_DA	1	Serial ROM data. Input data line from the SROM.
SromOE_L	O_OD_TP	1	Serial ROM enable. Supplies the output enable to the SROM.
SysAddIn_L[14:0]	I_DA	15	Time-multiplexed command/address/ID/Ack from system to the 21264/EV68A.
SysAddInClk_L	I_DA	1	Single-ended forwarded clock from system for SysAddIn_L[14:0] and SysFillValid_L .
SysAddOut_L[14:0]	O_OD	15	Time-multiplexed command/address/ID/mask from the 21264/EV68A to the system bus.
SysAddOutClk_L	O_OD	1	Single-ended forwarded clock output for SysAddOut_L[14:0] .
SysCheck_L[7:0]	B_DA_OD	8	Quadword ECC check bits for SysData_L[63:0] .
SysData_L[63:0]	B_DA_OD	64	Data bus for memory and I/O data.
SysDataInClk_H[7:0]	I_DA	8	Single-ended system-generated clocks for clock forwarded input system data.
SysDataInvalid_L	I_DA	1	When asserted, marks a valid data cycle for data transfers to the 21264/EV68A.
SysDataOutClk_L[7:0]	O_OD	8	Single-ended 21264/EV68A-generated clocks for clock forwarded output system data.
SysDataOutValid_L	I_DA	1	When asserted, marks a valid data cycle for data transfers from the 21264/EV68A.
SysFillValid_L	I_DA	1	When asserted, this bit indicates validation for the cache fill delivered in the previous system SysDc command.

Table 3–2 21264/EV68A Signal Descriptions (Continued)

Signal	Type	Count	Description
SysVref	I_DC_REF	1	System interface reference voltage.
Tck_H	I_DA	1	IEEE 1149.1 test clock.
Tdi_H	I_DA	1	IEEE 1149.1 test data-in signal.
Tdo_H	O_OD_TP	1	IEEE 1149.1 test data-out signal.
TestStat_H	O_OD_TP	1	Test status pin. System reset drives the test status pin low. The TestStat_H pin is forced high at the start of the Icache BiST. If the Icache BiST passes, the pin is deasserted at the end of the BiST operation; otherwise, it remains high. The 21264/EV68A generates a timeout reset signal if an instruction is not retired within one billion cycles. The 21264/EV68A signals the timeout reset event by outputting a 256 GCLK cycle wide pulse on TestStat_H .
Tms_H	I_DA	1	IEEE 1149.1 test mode select signal.
Trst_L	I_DA	1	IEEE 1149.1 test access port (TAP) reset signal.

Table 3–3 lists signals by function and provides an abbreviated description.

Table 3–3 21264/EV68A Signal Descriptions by Function

Signal	Type	Count	Description
BcVref Domain			
BcAdd_H[23:4]	O_PP	20	Bcache index.
BcCheck_H[15:0]	B_DA_PP	16	ECC check bits for BcData_H[127:0] .
BcData_H[127:0]	B_DA_PP	128	Bcache data.
BcDataInClk_H[7:0]	I_DA	8	Bcache data input clocks.
BcDataOE_L	O_PP	1	Bcache data output enable.
BcDataOutClk_H[3:0] BcDataOutClk_L[3:0]	O_PP	8	Bcache data output clocks.
BcDataWr_L	O_PP	1	Bcache data write enable.
BcLoad_L	O_PP	1	Bcache burst enable.
BcTag_H[42:20]	B_DA_PP	23	Bcache tag bits.
BcTagDirty_H	B_DA_PP	1	Tag dirty state bit.
BcTagInClk_H	I_DA	1	Bcache tag input clock.
BcTagOE_L	O_PP	1	Bcache tag output enable.
BcTagOutClk_H BcTagOutClk_L	O_PP	2	Bcache tag output clocks.
BcTagParity_H	B_DA_PP	1	Tag parity state bit.
BcTagShared_H	B_DA_PP	1	Tag shared state bit.
BcTagValid_H	B_DA_PP	1	Tag valid state bit.
BcTagWr_L	O_PP	1	Tag RAM write enable.

Table 3–3 21264/EV68A Signal Descriptions by Function (Continued)

Signal	Type	Count	Description
BcVref	I_DC_REF	1	Tag data input reference voltage.
SysVref Domain			
SysAddIn_L[14:0]	I_DA	15	Time-multiplexed SysAddIn, system-to-21264/EV68A.
SysAddInClk_L	I_DA	1	Single-ended forwarded clock from system for SysAddIn_L[14:0] and SysFillValid_L .
SysAddOut_L[14:0]	O_OD	15	Time-multiplexed SysAddOut, 21264/EV68A-to-system.
SysAddOutClk_L	O_OD	1	Single-ended forwarded-clock.
SysCheck_L[7:0]	B_DA_OD	8	Quadword ECC check bits for SysData_L[63:0] .
SysData_L[63:0]	B_DA_OD	64	Data bus for memory and I/O data.
SysDataInClk_H[7:0]	I_DA	8	Single-ended system-generated clocks for clock forwarded input system data.
SysDataInvalid_L	I_DA	1	When asserted, marks a valid data cycle for data transfers to the 21264/EV68A.
SysDataOutClk_L[7:0]	O_OD	8	Single-ended 21264/EV68A-generated clocks for clock forwarded output system data.
SysDataOutValid_L	I_DA	1	When asserted, marks a valid data cycle for data transfers from the 21264/EV68A.
SysFillValid_L	I_DA	1	Validation for fill given in previous SysDC command.
SysVref	I_DC_REF	1	System interface reference voltage.
Clocks and PLL			
ClkIn_H ClkIn_L	I_DA_CLK	2	Differential input signals provided by the system.
EV6Clk_H EV6Clk_L	O_PP_CLK	2	Provides an external test point to measure phase alignment of the PLL.
FrameClk_H FrameClk_L	I_DA_CLK	2	A skew-controlled differential 50% duty cycle copy of the system clock. It is used by the 21264/EV68A as a reference, or framing, clock.
PLL_VDD	2.5 V	1	2.5-V dedicated power supply for the 21264/EV68A PLL.
MiscVref Domain			
ClkFwdRst_H	I_DA	1	Systems assert this synchronous signal to wake up a powered-down 21264/EV68A. The ClkFwdRst_H signal is clocked into a 21264/EV68A register by the captured FrameClk_x signals.
DCOK_H	I_DA	1	dc voltage OK. Must be deasserted until dc voltage reaches proper operating level. After that, DCOK_H is asserted.
IRQ_H[5:0]	I_DA	6	These six interrupt signal lines may be asserted by the system.
MiscVref	I_DC_REF	1	Reference voltage for miscellaneous pins.
PIIBypass_H	I_DA	1	When asserted, this signal will cause the input clocks (ClkIn_x) to be applied to the 21264/EV68A internal circuits, instead of the 21264/EV68A's global clock (GCLK).

Pin Assignments

Table 3–3 21264/EV68A Signal Descriptions by Function (Continued)

Signal	Type	Count	Description
Reset_L	I_DA	1	System reset. This signal protects the 21264/EV68A from damage during initial power-up. It must be asserted until DCOK_H is asserted. After that, it is deasserted and the 21264/EV68A begins its reset sequence.
SromClk_H	O_OD_TP	1	Serial ROM clock.
SromData_H	I_DA	1	Serial ROM data.
SromOE_L	O_OD_TP	1	Serial ROM enable.
Tck_H	I_DA	1	IEEE 1149.1 test clock.
Tdi_H	I_DA	1	IEEE 1149.1 test data-in signal.
Tdo_H	O_OD_TP	1	IEEE 1149.1 test data-out signal.
TestStat_H	O_OD_TP	1	Test status pin.
Tms_H	I_DA	1	IEEE 1149.1 test mode select signal.
Trst_L	I_DA	1	IEEE 1149.1 test access port (TAP) reset signal.

3.3 Pin Assignments

The 21264/EV68A package has 587 pins aligned in a pin grid array (PGA) design. There are 380 functional signal pins, 1 dedicated 2.5-V pin for the PLL, 112 ground **VSS** pins, and 94 **VDD** pins. Table 3–4 lists the signal pins and their corresponding pin grid array (PGA) locations in alphabetical order for the signal type. Table 3–5 lists the pin grid array locations in alphabetical order.

Table 3–4 Pin List Sorted by Signal Name

Signal Name	PGA Location	Signal Name	PGA Location	Signal Name	PGA Location
BcAdd_H_10	B30	BcAdd_H_11	D30	BcAdd_H_12	C31
BcAdd_H_13	H28	BcAdd_H_14	G29	BcAdd_H_15	A33
BcAdd_H_16	E31	BcAdd_H_17	D32	BcAdd_H_18	B34
BcAdd_H_19	A35	BcAdd_H_20	B36	BcAdd_H_21	H30
BcAdd_H_22	C35	BcAdd_H_23	E33	BcAdd_H_4	B28
BcAdd_H_5	E27	BcAdd_H_6	A29	BcAdd_H_7	G27
BcAdd_H_8	C29	BcAdd_H_9	F28	BcCheck_H_0	F2
BcCheck_H_1	AB4	BcCheck_H_10	AW1	BcCheck_H_11	BD10
BcCheck_H_12	E45	BcCheck_H_13	AC45	BcCheck_H_14	AT44
BcCheck_H_15	BB36	BcCheck_H_2	AT2	BcCheck_H_3	BC11
BcCheck_H_4	M38	BcCheck_H_5	AB42	BcCheck_H_6	AU43
BcCheck_H_7	BC37	BcCheck_H_8	M8	BcCheck_H_9	AA3
BcData_H_0	B10	BcData_H_1	D10	BcData_H_10	L3
BcData_H_100	D42	BcData_H_101	D44	BcData_H_102	H40
BcData_H_103	H42	BcData_H_104	G45	BcData_H_105	L43

Table 3–4 Pin List Sorted by Signal Name (Continued)

Signal Name	PGA Location	Signal Name	PGA Location	Signal Name	PGA Location
BcData_H_106	L45	BcData_H_107	N45	BcData_H_108	T44
BcData_H_109	U45	BcData_H_11	M2	BcData_H_110	W45
BcData_H_111	AA43	BcData_H_112	AC43	BcData_H_113	AD44
BcData_H_114	AE41	BcData_H_115	AG45	BcData_H_116	AK44
BcData_H_117	AL43	BcData_H_118	AM42	BcData_H_119	AR45
BcData_H_12	T2	BcData_H_120	AP40	BcData_H_121	BA45
BcData_H_122	AV42	BcData_H_123	BB44	BcData_H_124	BB42
BcData_H_125	BC41	BcData_H_126	BA37	BcData_H_127	BD40
BcData_H_13	U1	BcData_H_14	V2	BcData_H_15	Y4
BcData_H_16	AC1	BcData_H_17	AD2	BcData_H_18	AE3
BcData_H_19	AG1	BcData_H_2	A5	BcData_H_20	AK2
BcData_H_21	AL3	BcData_H_22	AR1	BcData_H_23	AP2
BcData_H_24	AY2	BcData_H_25	BB2	BcData_H_26	AW5
BcData_H_27	BB4	BcData_H_28	BB8	BcData_H_29	BE5
BcData_H_3	C5	BcData_H_30	BB10	BcData_H_31	BE7
BcData_H_32	G33	BcData_H_33	C37	BcData_H_34	B40
BcData_H_35	C41	BcData_H_36	C43	BcData_H_37	E43
BcData_H_38	G41	BcData_H_39	F44	BcData_H_4	C3
BcData_H_40	K44	BcData_H_41	N41	BcData_H_42	M44
BcData_H_43	P42	BcData_H_44	U43	BcData_H_45	V44
BcData_H_46	Y42	BcData_H_47	AB44	BcData_H_48	AD42
BcData_H_49	AE43	BcData_H_5	E3	BcData_H_50	AF42
BcData_H_51	AJ45	BcData_H_52	AK42	BcData_H_53	AN45
BcData_H_54	AP44	BcData_H_55	AN41	BcData_H_56	AW45
BcData_H_57	AU41	BcData_H_58	AY44	BcData_H_59	BA43
BcData_H_6	H6	BcData_H_60	BC43	BcData_H_61	BD42
BcData_H_62	BB38	BcData_H_63	BE41	BcData_H_64	C11
BcData_H_65	A7	BcData_H_66	C9	BcData_H_67	B6
BcData_H_68	B4	BcData_H_69	D4	BcData_H_7	E1
BcData_H_70	G5	BcData_H_71	D2	BcData_H_72	H4
BcData_H_73	G1	BcData_H_74	N5	BcData_H_75	L1
BcData_H_76	N1	BcData_H_77	U3	BcData_H_78	W5
BcData_H_79	W1	BcData_H_8	J3	BcData_H_80	AB2
BcData_H_81	AC3	BcData_H_82	AD4	BcData_H_83	AF4
BcData_H_84	AJ3	BcData_H_85	AK4	BcData_H_86	AN1
BcData_H_87	AM4	BcData_H_88	AU5	BcData_H_89	BA1

Pin Assignments

Table 3–4 Pin List Sorted by Signal Name (Continued)

Signal Name	PGA Location	Signal Name	PGA Location	Signal Name	PGA Location
BcData_H_9	K2	BcData_H_90	BA3	BcData_H_91	BC3
BcData_H_92	BD6	BcData_H_93	BA9	BcData_H_94	BC9
BcData_H_95	AY12	BcData_H_96	A39	BcData_H_97	D36
BcData_H_98	A41	BcData_H_99	B42	BcDataInClk_H_0	E7
BcDataInClk_H_1	R3	BcDataInClk_H_2	AH2	BcDataInClk_H_3	BC5
BcDataInClk_H_4	F38	BcDataInClk_H_5	U39	BcDataInClk_H_6	AH44
BcDataInClk_H_7	AY40	BcDataOE_L	A27	BcDataOutClk_H_0	J5
BcDataOutClk_H_1	AU3	BcDataOutClk_H_2	J43	BcDataOutClk_H_3	AR43
BcDataOutClk_L_0	K4	BcDataOutClk_L_1	AV4	BcDataOutClk_L_2	K42
BcDataOutClk_L_3	AT42	BcDataWr_L	D26	BcLoad_L	F26
BcTag_H_20	E13	BcTag_H_21	H16	BcTag_H_22	A11
BcTag_H_23	B12	BcTag_H_24	D14	BcTag_H_25	E15
BcTag_H_26	A13	BcTag_H_27	G17	BcTag_H_28	C15
BcTag_H_29	H18	BcTag_H_30	D16	BcTag_H_31	B16
BcTag_H_32	C17	BcTag_H_33	A17	BcTag_H_34	E19
BcTag_H_35	B18	BcTag_H_36	A19	BcTag_H_37	F20
BcTag_H_38	D20	BcTag_H_39	E21	BcTag_H_40	C21
BcTag_H_41	D22	BcTag_H_42	H22	BcTagDirty_H	C23
BcTagInClk_H	G19	BcTagOE_L	H24	BcTagOutClk_H	C25
BcTagOutClk_L	D24	BcTagParity_H	B22	BcTagShared_H	G23
BcTagValid_H	B24	BcTagWr_L	E25	BcVref	F18
ClkFwdRst_H	BE11	ClkIn_H	AM8	ClkIn_L	AN7
DCOK_H	AY18	EV6Clk_H	AM6	EV6Clk_L	AL7
FrameClk_H	AV16	FrameClk_L	AW15	IRQ_H_0	BA15
IRQ_H_1	BE13	IRQ_H_2	AW17	IRQ_H_3	AV18
IRQ_H_4	BC15	IRQ_H_5	BB16	MiscVref	AV22
NoConnect	BB14	NoConnect	BD2	PLL_VDD	AV8
PIlBypass_H	BD12	Reset_L	BD16	Spare	AJ1
Spare	V38	Spare	AT4	Spare	BE9
Spare	F8	Spare	BD4	Spare	AJ43
Spare	AR3	Spare	T4	Spare	E39
Spare	BA39	Spare	BC21	SromClk_H	AW19
SromData_H	BC17	SromOE_L	BE17	SysAddIn_L_0	BD30
SysAddIn_L_1	BC29	SysAddIn_L_10	BB24	SysAddIn_L_11	AV24
SysAddIn_L_12	BD24	SysAddIn_L_13	BE23	SysAddIn_L_14	AW23
SysAddIn_L_2	AY28	SysAddIn_L_3	BE29	SysAddIn_L_4	AW27

Table 3–4 Pin List Sorted by Signal Name (Continued)

Signal Name	PGA Location	Signal Name	PGA Location	Signal Name	PGA Location
SysAddIn_L_5	BA27	SysAddIn_L_6	BD28	SysAddIn_L_7	BE27
SysAddIn_L_8	AY26	SysAddIn_L_9	BC25	SysAddInClk_L	BB26
SysAddOut_L_0	AW33	SysAddOut_L_1	BE39	SysAddOut_L_10	BE33
SysAddOut_L_11	AW29	SysAddOut_L_12	BC31	SysAddOut_L_13	AV28
SysAddOut_L_14	BB30	SysAddOut_L_2	BD36	SysAddOut_L_3	BC35
SysAddOut_L_4	BA33	SysAddOut_L_5	AY32	SysAddOut_L_6	BE35
SysAddOut_L_7	AV30	SysAddOut_L_8	BB32	SysAddOut_L_9	BA31
SysAddOutClk_L	BD34	SysCheck_L_0	L7	SysCheck_L_1	AA5
SysCheck_L_2	AK8	SysCheck_L_3	BA13	SysCheck_L_4	L39
SysCheck_L_5	AA41	SysCheck_L_6	AM40	SysCheck_L_7	AY34
SysData_L_0	F14	SysData_L_1	G13	SysData_L_10	P6
SysData_L_11	T8	SysData_L_12	V8	SysData_L_13	V6
SysData_L_14	W7	SysData_L_15	Y6	SysData_L_16	AB8
SysData_L_17	AC7	SysData_L_18	AD8	SysData_L_19	AE5
SysData_L_2	F12	SysData_L_20	AH6	SysData_L_21	AH8
SysData_L_22	AJ7	SysData_L_23	AL5	SysData_L_24	AP8
SysData_L_25	AR7	SysData_L_26	AT8	SysData_L_27	AV6
SysData_L_28	AV10	SysData_L_29	AW11	SysData_L_3	H12
SysData_L_30	AV12	SysData_L_31	AW13	SysData_L_32	F32
SysData_L_33	F34	SysData_L_34	H34	SysData_L_35	G35
SysData_L_36	F40	SysData_L_37	G39	SysData_L_38	K38
SysData_L_39	J41	SysData_L_4	H10	SysData_L_40	M40
SysData_L_41	N39	SysData_L_42	P40	SysData_L_43	T38
SysData_L_44	V40	SysData_L_45	W41	SysData_L_46	W39
SysData_L_47	Y40	SysData_L_48	AB38	SysData_L_49	AC39
SysData_L_5	G7	SysData_L_50	AD38	SysData_L_51	AF40
SysData_L_52	AH38	SysData_L_53	AJ39	SysData_L_54	AL41
SysData_L_55	AK38	SysData_L_56	AN39	SysData_L_57	AP38
SysData_L_58	AR39	SysData_L_59	AT38	SysData_L_6	F6
SysData_L_60	AY38	SysData_L_61	AV36	SysData_L_62	AW35
SysData_L_63	AV34	SysData_L_7	K8	SysData_L_8	M6
SysData_L_9	N7	SysDataInClk_H_0	D8	SysDataInClk_H_1	P4
SysDataInClk_H_2	AF6	SysDataInClk_H_3	AY6	SysDataInClk_H_4	E37
SysDataInClk_H_5	R43	SysDataInClk_H_6	AG41	SysDataInClk_H_7	AV40
SysDataInvalid_L	BD22	SysDataOutClk_L_0	G11	SysDataOutClk_L_1	U7
SysDataOutClk_L_2	AG7	SysDataOutClk_L_3	AY8	SysDataOutClk_L_4	H36

Pin Assignments

Table 3–4 Pin List Sorted by Signal Name (Continued)

Signal Name	PGA Location	Signal Name	PGA Location	Signal Name	PGA Location
SysDataOutClk_L_5	R41	SysDataOutClk_L_6	AH40	SysDataOutClk_L_7	AW39
SysDataOutValid_L	BB22	SysFillValid_L	BC23	SysVref	BA25
Tck_H	BE19	Tdi_H	BA21	Tdo_H	BB20
TestStat_H	BA19	Tms_H	BD18	Trst_L	AY20

Table 3–5 Pin List Sorted by PGA Location

PGA Location	Signal Name	PGA Location	Signal Name	PGA Location	Signal Name
A11	BcTag_H_22	A13	BcTag_H_26	A17	BcTag_H_33
A19	BcTag_H_36	A27	BcDataOE_L	A29	BcAdd_H_6
A33	BcAdd_H_15	A35	BcAdd_H_19	A39	BcData_H_96
A41	BcData_H_98	A5	BcData_H_2	A7	BcData_H_65
AA3	BcCheck_H_9	AA41	SysCheck_L_5	AA43	BcData_H_111
AA5	SysCheck_L_1	AB2	BcData_H_80	AB38	SysData_L_48
AB4	BcCheck_H_1	AB42	BcCheck_H_5	AB44	BcData_H_47
AB8	SysData_L_16	AC1	BcData_H_16	AC3	BcData_H_81
AC39	SysData_L_49	AC43	BcData_H_112	AC45	BcCheck_H_13
AC7	SysData_L_17	AD2	BcData_H_17	AD38	SysData_L_50
AD4	BcData_H_82	AD42	BcData_H_48	AD44	BcData_H_113
AD8	SysData_L_18	AE3	BcData_H_18	AE41	BcData_H_114
AE43	BcData_H_49	AE5	SysData_L_19	AF4	BcData_H_83
AF40	SysData_L_51	AF42	BcData_H_50	AF6	SysDataInClk_H_2
AG1	BcData_H_19	AG41	SysDataInClk_H_6	AG45	BcData_H_115
AG7	SysDataOutClk_L_2	AH2	BcDataInClk_H_2	AH38	SysData_L_52
AH40	SysDataOutClk_L_6	AH44	BcDataInClk_H_6	AH6	SysData_L_20
AH8	SysData_L_21	AJ1	Spare	AJ3	BcData_H_84
AJ39	SysData_L_53	AJ43	Spare	AJ45	BcData_H_51
AJ7	SysData_L_22	AK2	BcData_H_20	AK38	SysData_L_55
AK4	BcData_H_85	AK42	BcData_H_52	AK44	BcData_H_116
AK8	SysCheck_L_2	AL3	BcData_H_21	AL41	SysData_L_54
AL43	BcData_H_117	AL5	SysData_L_23	AL7	EV6Clk_L
AM4	BcData_H_87	AM40	SysCheck_L_6	AM42	BcData_H_118
AM6	EV6Clk_H	AM8	ClkIn_H	AN1	BcData_H_86
AN39	SysData_L_56	AN41	BcData_H_55	AN45	BcData_H_53
AN7	ClkIn_L	AP2	BcData_H_23	AP38	SysData_L_57
AP40	BcData_H_120	AP44	BcData_H_54	AP8	SysData_L_24

Table 3–5 Pin List Sorted by PGA Location (Continued)

PGA Location	Signal Name	PGA Location	Signal Name	PGA Location	Signal Name
AR1	BcData_H_22	AR3	Spare	AR39	SysData_L_58
AR43	BcDataOutClk_H_3	AR45	BcData_H_119	AR7	SysData_L_25
AT2	BcCheck_H_2	AT38	SysData_L_59	AT4	Spare
AT42	BcDataOutClk_L_3	AT44	BcCheck_H_14	AT8	SysData_L_26
AU3	BcDataOutClk_H_1	AU41	BcData_H_57	AU43	BcCheck_H_6
AU5	BcData_H_88	AV10	SysData_L_28	AV12	SysData_L_30
AV16	FrameClk_H	AV18	IRQ_H_3	AV22	MiscVref
AV24	SysAddIn_L_11	AV28	SysAddOut_L_13	AV30	SysAddOut_L_7
AV34	SysData_L_63	AV36	SysData_L_61	AV4	BcDataOutClk_L_1
AV40	SysDataInClk_H_7	AV42	BcData_H_122	AV6	SysData_L_27
AV8	PLL_VDD	AW1	BcCheck_H_10	AW11	SysData_L_29
AW13	SysData_L_31	AW15	FrameClk_L	AW17	IRQ_H_2
AW19	SromClk_H	AW23	SysAddIn_L_14	AW27	SysAddIn_L_4
AW29	SysAddOut_L_11	AW33	SysAddOut_L_0	AW35	SysData_L_62
AW39	SysDataOutClk_L_7	AW45	BcData_H_56	AW5	BcData_H_26
AY12	BcData_H_95	AY18	DCOK_H	AY2	BcData_H_24
AY20	Trst_L	AY26	SysAddIn_L_8	AY28	SysAddIn_L_2
AY32	SysAddOut_L_5	AY34	SysCheck_L_7	AY38	SysData_L_60
AY40	BcDataInClk_H_7	AY44	BcData_H_58	AY6	SysDataInClk_H_3
AY8	SysDataOutClk_L_3	B10	BcData_H_0	B12	BcTag_H_23
B16	BcTag_H_31	B18	BcTag_H_35	B22	BcTagParity_H
B24	BcTagValid_H	B28	BcAdd_H_4	B30	BcAdd_H_10
B34	BcAdd_H_18	B36	BcAdd_H_20	B4	BcData_H_68
B40	BcData_H_34	B42	BcData_H_99	B6	BcData_H_67
BA1	BcData_H_89	BA13	SysCheck_L_3	BA15	IRQ_H_0
BA19	TestStat_H	BA21	Tdi_H	BA25	SysVref
BA27	SysAddIn_L_5	BA3	BcData_H_90	BA31	SysAddOut_L_9
BA33	SysAddOut_L_4	BA37	BcData_H_126	BA39	Spare
BA43	BcData_H_59	BA45	BcData_H_121	BA9	BcData_H_93
BB10	BcData_H_30	BB14	NoConnect	BB16	IRQ_H_5
BB2	BcData_H_25	BB20	Tdo_H	BB22	SysDataOutValid_L
BB24	SysAddIn_L_10	BB26	SysAddInClk_L	BB30	SysAddOut_L_14
BB32	SysAddOut_L_8	BB36	BcCheck_H_15	BB38	BcData_H_62
BB4	BcData_H_27	BB42	BcData_H_124	BB44	BcData_H_123
BB8	BcData_H_28	BC11	BcCheck_H_3	BC15	IRQ_H_4
BC17	SromData_H	BC21	Spare	BC23	SysFillValid_L

Pin Assignments

Table 3–5 Pin List Sorted by PGA Location (Continued)

PGA Location	Signal Name	PGA Location	Signal Name	PGA Location	Signal Name
BC25	SysAddIn_L_9	BC29	SysAddIn_L_1	BC3	BcData_H_91
BC31	SysAddOut_L_12	BC35	SysAddOut_L_3	BC37	BcCheck_H_7
BC41	BcData_H_125	BC43	BcData_H_60	BC5	BcDataInClk_H_3
BC9	BcData_H_94	BD10	BcCheck_H_11	BD12	PIlBypass_H
BD16	Reset_L	BD18	Tms_H	BD2	NoConnect
BD22	SysDataInValid_L	BD24	SysAddIn_L_12	BD28	SysAddIn_L_6
BD30	SysAddIn_L_0	BD34	SysAddOutClk_L	BD36	SysAddOut_L_2
BD4	Spare	BD40	BcData_H_127	BD42	BcData_H_61
BD6	BcData_H_92	BE11	ClkFwdRst_H	BE13	IRQ_H_1
BE17	SromOE_L	BE19	Tck_H	BE23	SysAddIn_L_13
BE27	SysAddIn_L_7	BE29	SysAddIn_L_3	BE33	SysAddOut_L_10
BE35	SysAddOut_L_6	BE39	SysAddOut_L_1	BE41	BcData_H_63
BE5	BcData_H_29	BE7	BcData_H_31	BE9	Spare
C11	BcData_H_64	C15	BcTag_H_28	C17	BcTag_H_32
C21	BcTag_H_40	C23	BcTagDirty_H	C25	BcTagOutClk_H
C29	BcAdd_H_8	C3	BcData_H_4	C31	BcAdd_H_12
C35	BcAdd_H_22	C37	BcData_H_33	C41	BcData_H_35
C43	BcData_H_36	C5	BcData_H_3	C9	BcData_H_66
D10	BcData_H_1	D14	BcTag_H_24	D16	BcTag_H_30
D2	BcData_H_71	D20	BcTag_H_38	D22	BcTag_H_41
D24	BcTagOutClk_L	D26	BcDataWr_L	D30	BcAdd_H_11
D32	BcAdd_H_17	D36	BcData_H_97	D4	BcData_H_69
D42	BcData_H_100	D44	BcData_H_101	D8	SysDataInClk_H_0
E1	BcData_H_7	E13	BcTag_H_20	E15	BcTag_H_25
E19	BcTag_H_34	E21	BcTag_H_39	E25	BcTagWr_L
E27	BcAdd_H_5	E3	BcData_H_5	E31	BcAdd_H_16
E33	BcAdd_H_23	E37	SysDataInClk_H_4	E39	Spare
E43	BcData_H_37	E45	BcCheck_H_12	E7	BcDataInClk_H_0
F12	SysData_L_2	F14	SysData_L_0	F18	BcVref
F2	BcCheck_H_0	F20	BcTag_H_37	F26	BcLoad_L
F28	BcAdd_H_9	F32	SysData_L_32	F34	SysData_L_33
F38	BcDataInClk_H_4	F40	SysData_L_36	F44	BcData_H_39
F6	SysData_L_6	F8	Spare	G1	BcData_H_73
G11	SysDataOutClk_L_0	G13	SysData_L_1	G17	BcTag_H_27
G19	BcTagInClk_H	G23	BcTagShared_H	G27	BcAdd_H_7
G29	BcAdd_H_14	G33	BcData_H_32	G35	SysData_L_35

Table 3–5 Pin List Sorted by PGA Location (Continued)

PGA Location	Signal Name	PGA Location	Signal Name	PGA Location	Signal Name
G39	SysData_L_37	G41	BcData_H_38	G45	BcData_H_104
G5	BcData_H_70	G7	SysData_L_5	H10	SysData_L_4
H12	SysData_L_3	H16	BcTag_H_21	H18	BcTag_H_29
H22	BcTag_H_42	H24	BcTagOE_L	H28	BcAdd_H_13
H30	BcAdd_H_21	H34	SysData_L_34	H36	SysDataOutClk_L_4
H4	BcData_H_72	H40	BcData_H_102	H42	BcData_H_103
H6	BcData_H_6	J3	BcData_H_8	J41	SysData_L_39
J43	BcDataOutClk_H_2	J5	BcDataOutClk_H_0	K2	BcData_H_9
K38	SysData_L_38	K4	BcDataOutClk_L_0	K42	BcDataOutClk_L_2
K44	BcData_H_40	K8	SysData_L_7	L1	BcData_H_75
L3	BcData_H_10	L39	SysCheck_L_4	L43	BcData_H_105
L45	BcData_H_106	L7	SysCheck_L_0	M2	BcData_H_11
M38	BcCheck_H_4	M40	SysData_L_40	M44	BcData_H_42
M6	SysData_L_8	M8	BcCheck_H_8	N1	BcData_H_76
N39	SysData_L_41	N41	BcData_H_41	N45	BcData_H_107
N5	BcData_H_74	N7	SysData_L_9	P4	SysDataInClk_H_1
P40	SysData_L_42	P42	BcData_H_43	P6	SysData_L_10
R3	BcDataInClk_H_1	R41	SysDataOutClk_L_5	R43	SysDataInClk_H_5
T2	BcData_H_12	T38	SysData_L_43	T4	Spare
T44	BcData_H_108	T8	SysData_L_11	U1	BcData_H_13
U3	BcData_H_77	U39	BcDataInClk_H_5	U43	BcData_H_44
U45	BcData_H_109	U7	SysDataOutClk_L_1	V2	BcData_H_14
V38	Spare	V40	SysData_L_44	V44	BcData_H_45
V6	SysData_L_13	V8	SysData_L_12	W1	BcData_H_79
W39	SysData_L_46	W41	SysData_L_45	W45	BcData_H_110
W5	BcData_H_78	W7	SysData_L_14	Y4	BcData_H_15
Y40	SysData_L_47	Y42	BcData_H_46	Y6	SysData_L_15

Pin Assignments

Table 3–6 lists the 21264/EV68A ground and power (**VSS** and **VDD**, respectively) pin list.

Table 3–6 Ground and Power (VSS and VDD) Pin List

Signal	PGA Location									
VSS	A15	A21	A25	A3	A31	A37	A43	A9	AA1	AA39
	AA45	AA7	AC41	AC5	AE1	AE39	AE45	AE7	AG3	AG39
	AG43	AG5	AJ41	AJ5	AL1	AL39	AL45	AN3	AN43	AN5
	AR41	AR5	AU1	AU39	AU45	AU7	AW21	AW25	AW3	AW31
	AW37	AW41	AW43	AW7	AW9	AY14	BA11	BA17	BA23	BA29
	BA35	BA41	BA5	BA7	BC1	BC13	BC19	BC27	BC33	BC39
	BC45	BC7	BE15	BE21	BE25	BE3	BE31	BE37	BE43	C1
	C13	C19	C27	C33	C39	C45	C7	DS8	E11	E17
	E23	E29	E35	E41	E5	E9	G15	G21	G25	G3
	G31	G37	G43	G9	J1	J39	J45	J7	L41	L5
	N3	N43	R1	R39	R45	R5	R7	T42	U41	U5
	W3	W43	—	—	—	—	—	—	—	—
	VDD	A23	AB40	AB6	AD40	AD6	AF2	AF38	AF44	AF8
AH42		AK40	AK6	AM2	AM38	AM44	AP4	AP42	AP6	AT40
AT6		AV14	AV2	AV20	AV26	AV32	AV38	AV44	AY10	AY16
AY22		AY24	AY30	AY36	AY4	AY42	B14	B2	B20	B26
B32		B38	B44	B8	BB12	BB18	BB28	BB34	BB40	BB6
BD14		BD20	BD26	BD32	BD38	BD44	BD8	D12	D18	D28
D34		D40	D6	F10	F16	F22	F24	F30	F36	F4
F42		H14	H2	H20	H26	H32	H38	H44	K40	K6
M4		M42	P2	P38	P44	P8	T40	T6	V4	V42
Y2		Y38	Y44	Y8	—	—	—	—	—	—

3.4 Mechanical Specifications

This section shows the 21264/EV68A mechanical package dimensions without a heat sink. For heat sink information and dimensions, refer to Chapter 10.

Figure 3–2 shows the package physical dimensions without a heat sink.

Figure 3–2 Package Dimensions

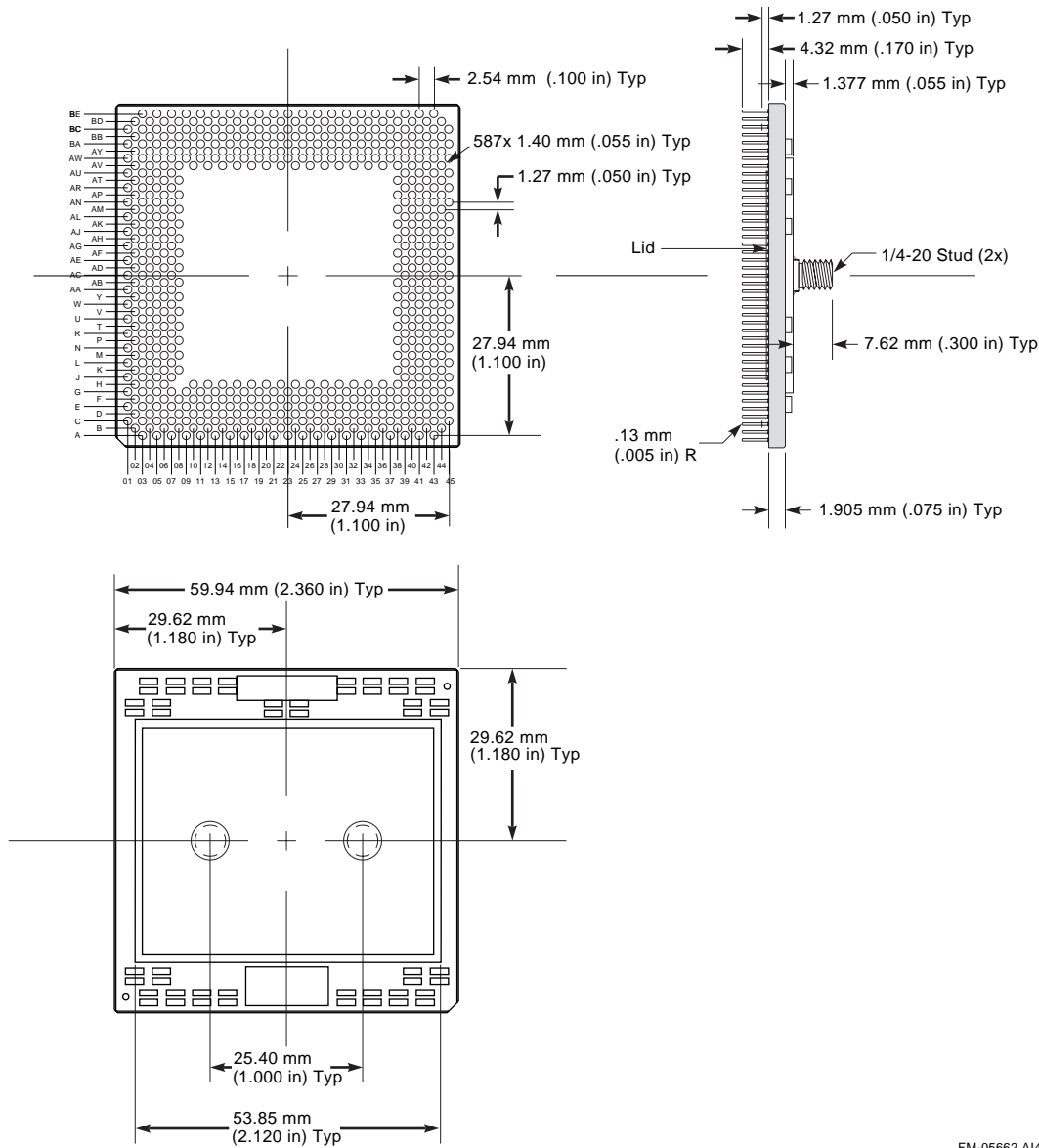

FM-05662.A14

3.5 21264/EV68A Packaging

Figure 3-3 shows the 21264/EV68A pinout from the top view with pins facing down.

Figure 3-3 21264/EV68A Top View (Pin Down)

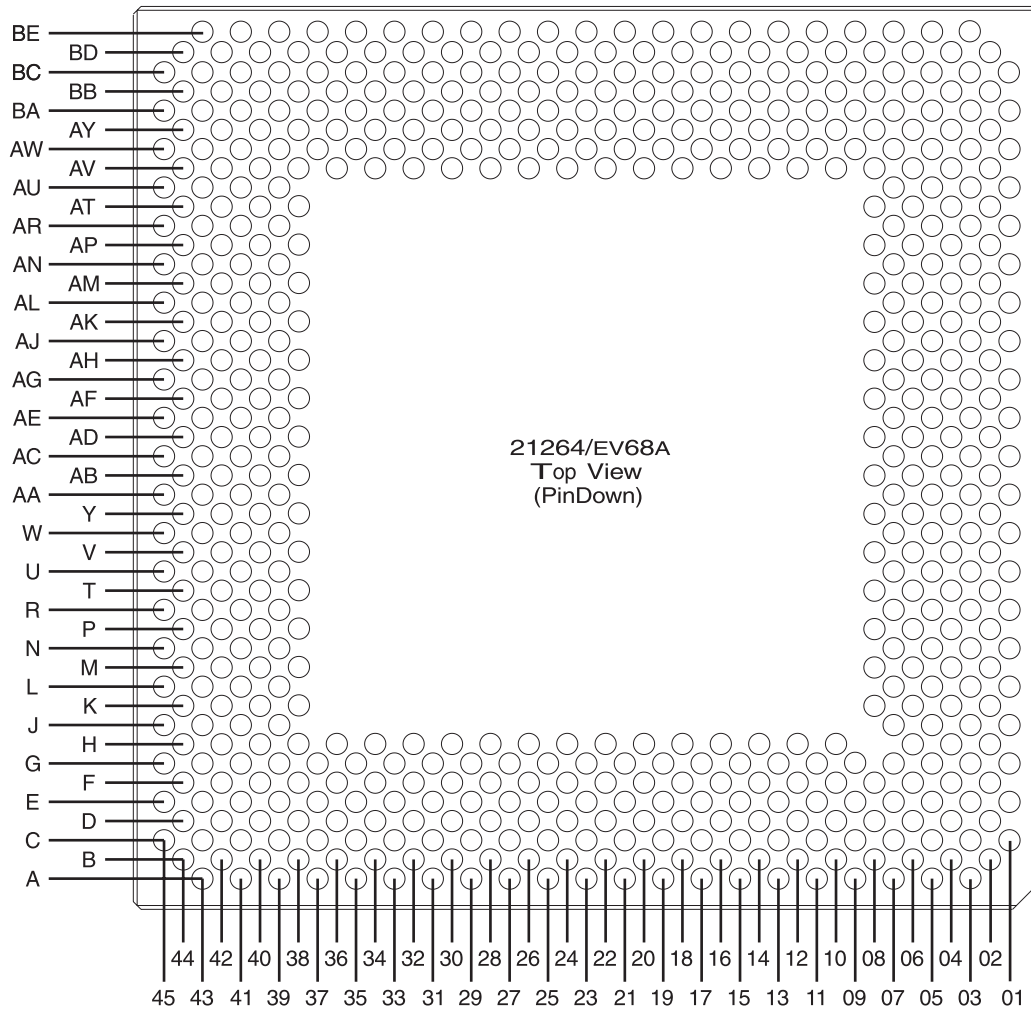

FM-05644

Figure 3-4 shows the 21264/EV68A pinout from the bottom view with pins facing up.

Figure 3-4 21264/EV68A Bottom View (Pin Up)

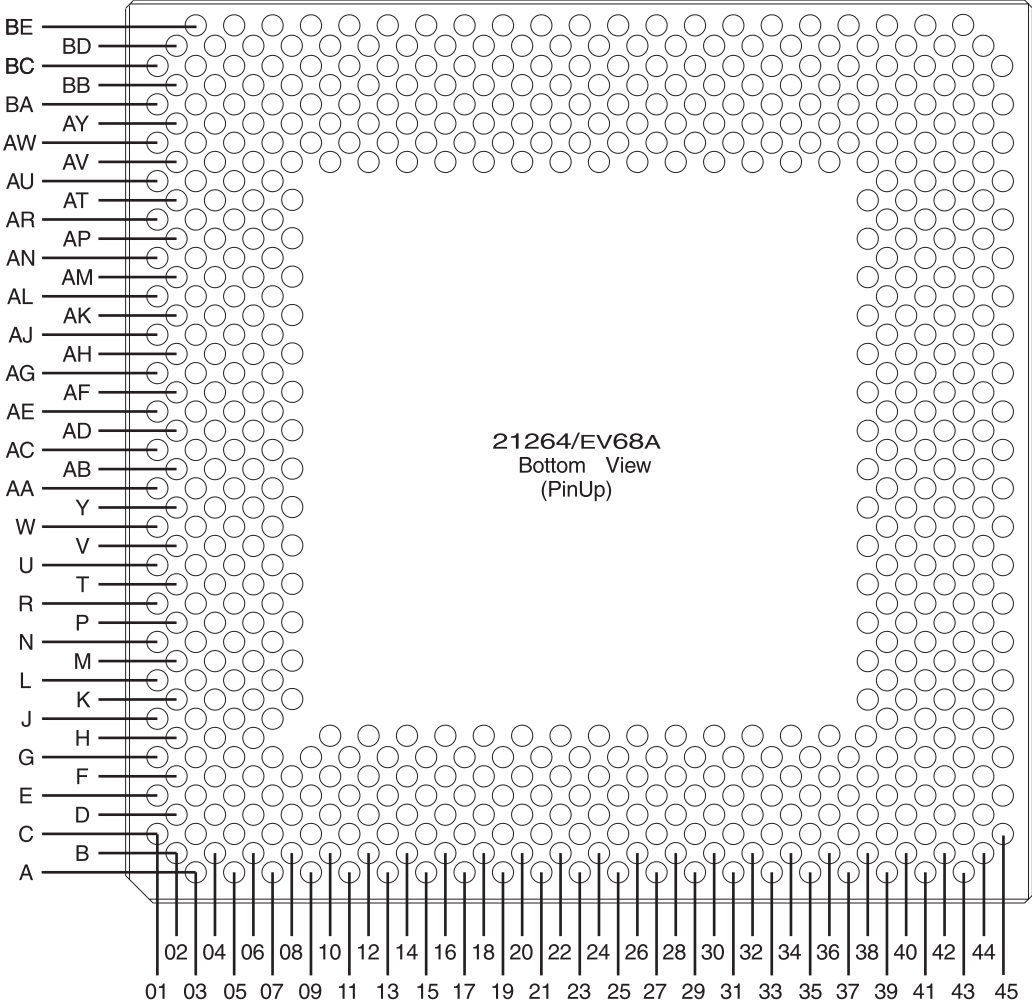

FM-05645

Cache and External Interfaces

This chapter describes the 21264/EV68A cache and external interface, which includes the second-level cache (Bcache) interface and the system interface. It also describes locks, interrupt signals, and ECC/parity generation. It is organized as follows:

- Introduction to the external interfaces
- Physical address considerations
- Bcache structure
- Victim data buffer
- Cache coherency
- Lock mechanism
- System port
- Bcache port
- Interrupts

Chapter 3 lists and defines all 21264/EV68A hardware interface signal pins. Chapter 9 describes the 21264/EV68A hardware interface electrical requirements.

4.1 Introduction to the External Interfaces

A 21264/EV68A-based system can be divided into three major sections:

- 21264/EV68A microprocessor
- Second-level Bcache
- System interface logic
 - Optional duplicate tag store
 - Optional lock register
 - Optional victim buffers

The 21264/EV68A external interface is flexible and mandates few design rules, allowing a wide range of prospective systems. The external interface is composed of the Bcache interface and the system interface.

- Input clocks must have the same frequency as their corresponding output clock. For example, the frequency of **SysAddInClk_L** must be the same as **SysAddOutClk_L**.

Introduction to the External Interfaces

- The Bcache interface includes a 128-bit bidirectional data bus, a 20-bit unidirectional address bus, and several control signals.
 - The **BcDataOutClk_x[3:0]** clocks are free-running and are derived from the internal GCLK. The period of **BcDataOutClk_x[3:0]** is a programmable multiple of GCLK.
 - The Bcache turns the **BcDataOutClk_x[3:0]** clocks around and returns them to the 21264/EV68A as **BcDataInClk_H[7:0]**. Likewise, **BcTagOutClk_x** returns as **BcTagInClk_H**.
 - The Bcache interface supports a 64-byte block size.
- The system interface includes a 64-bit bidirectional data bus, two 15-bit unidirectional address buses, and several control signals.
 - The **SysAddOutClk_L** clock is free-running and is derived from the internal GCLK. The period of **SysAddOutClk_L** is a programmable multiple of GCLK.
 - The **SysAddInClk_L** clock is a turned-around copy of **SysAddOutClk_L**.

Figure 4–1 shows a simplified view of the external interface. The function and purpose of each signal is described in Chapter 3.

Figure 4–1 21264/EV68A System and Bcache Interfaces

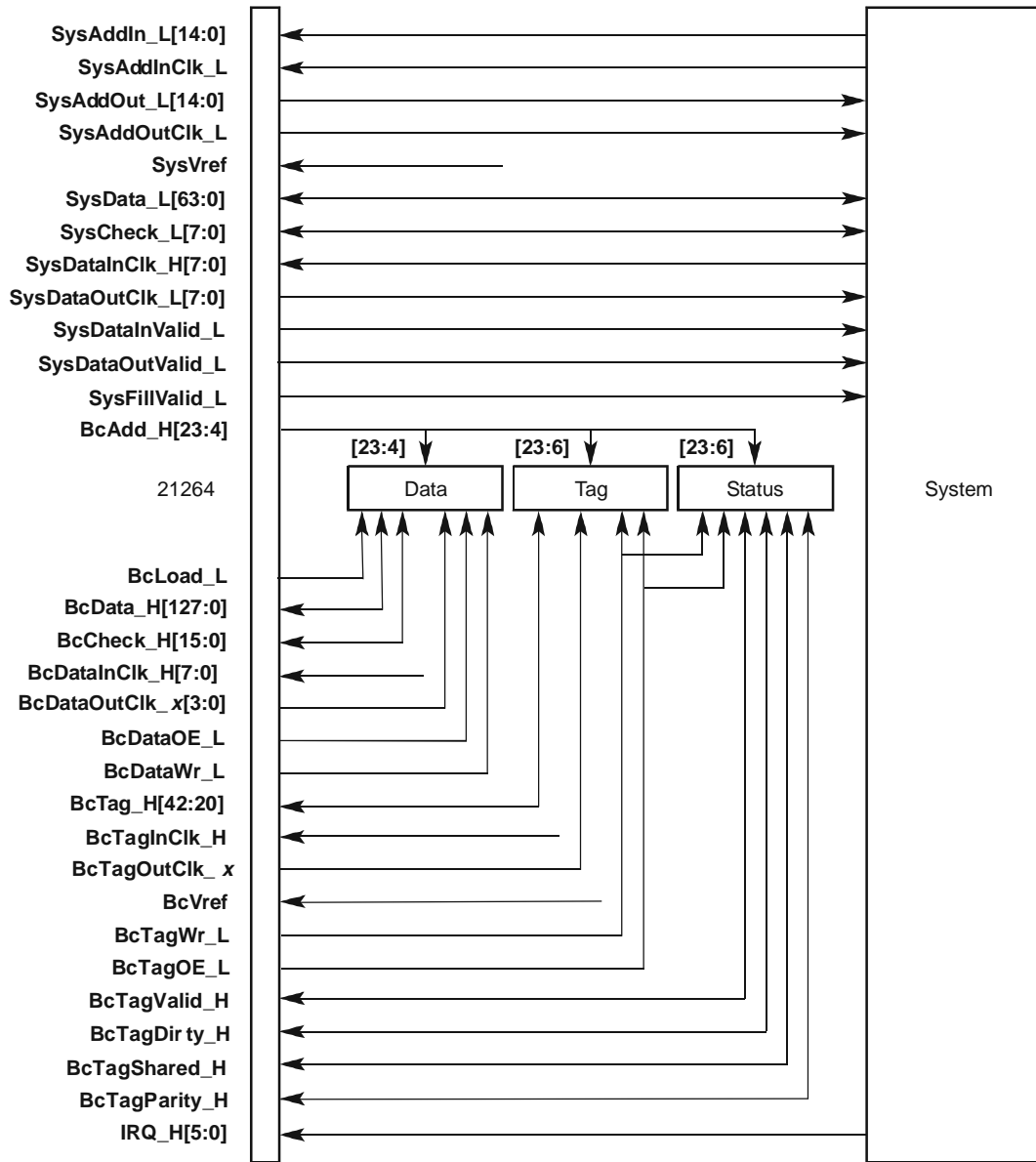

FM-05818B-EV67

4.1.1 System Interface

This section introduces the system (external) bus interface. The system interface is made up of two unidirectional 15-bit address buses, 64 bidirectional data lines, eight bidirectional check bits, two single-ended unidirectional clocks, and a few control pins. The 15-bit address buses provide time-shared address/command/ID in two or four GCLK cycles. The Cbox controls the system interface.

Physical Address Considerations

4.1.1.1 Commands and Addresses

The system sends probe and data movement commands to the 21264/EV68A. The 21264/EV68A can hold up to eight probe commands from the system. The system controls the number of outstanding probe commands and must ensure that the 21264/EV68A 8-entry probe queue does not overflow.

The Cbox contains an 8-entry miss buffer (MAF) and an 8-entry victim buffer (VAF).

A miss occurs when the 21264/EV68A probes the Bcache but does not find the addressed block. The 21264/EV68A can queue eight cache misses to the system in its MAF.

4.1.2 Second-Level Cache (Bcache) Interface

The 21264/EV68A Cbox provides control signals and an interface for a second-level cache, the Bcache. The 21264/EV68A supports a Bcache from 1MB to 16MB, with 64-byte blocks. A 128-bit data bus is used for transfers between the 21264/EV68A and the Bcache. The Bcache must be comprised of synchronous static RAMs (SSRAMs) and must contain either one, two, or three internal registers. All Bcache control and address pins are clocked synchronously on Bcache cycle boundaries. The Bcache clock rate varies as a multiple of the CPU clock cycle in half-cycle increments from 1.5 to 4.0, and in full-cycle increments of 5, 6, 7, and 8 times the CPU clock cycle. The 1.5 multiple is only available in dual-data mode.

4.2 Physical Address Considerations

The 21264/EV68A supports a 44-bit physical address space that is divided equally between memory space and I/O space. Memory space resides in the lower half of the physical address space ($PA[43] = 0$) and I/O space resides in the upper half of the physical address space ($PA[43] = 1$). The 21264/EV68A recognizes these spaces internally.

The 21264/EV68A-generated external references to memory space are always of a fixed 64-byte size, though the internal access granularity is byte, word, longword, or quadword. All 21264/EV68A-generated external references to memory or I/O space are physical addresses that are either successfully translated from a virtual address or produced by PALcode. Speculative execution may cause a reference to nonexistent memory. Systems must check the range of all addresses and report nonexistent addresses to the 21264/EV68A.

Table 4–1 describes the translation of internal references to external interface references. The first column lists the instructions used by the programmer, including load (LDx) and store (STx) instructions of several sizes. The column headings are described here:

- DcHit (block was found in the Dcache)
- DcW (block was found in a writable state in the Dcache)
- BcHit (block was found in the Bcache)
- BcW (block was found in a writable state in the Bcache)
- Status and Action (status at end of instruction and action performed by the 21264/EV68A)

Prefetches (LDL, LDF, LDG, LDT, LDBU, LDWU) to R31 use the LDx flow, and prefetch with modify intent (LDS) uses the STx flow. If the prefetch target is addressed to I/O space, the upper address bit is cleared, converting the address to memory space (PA[42:6]). Notes follow the table.

Table 4–1 Translation of Internal References to External Interface Reference

Instruction	DcHit	DcW	BcHit	BcW	Status and Action
LDx Memory	1	X	X	X	Dcache hit, done.
LDx Memory	0	X	1	X	Bcache hit, done.
LDx Memory	0	X	0	X	Miss, generate RdBlk command.
LDx I/O	X	X	X	X	RdBytes, RdLWs, or RdQWs based on size.
Istream Memory	1	X	X	X	Dcache hit, Istream serviced from Dcache.
Istream Memory	0	X	1	X	Bcache hit, Istream serviced from Bcache.
Istream Memory	0	X	0	X	Miss, generate RdBlkI command.
STx Memory	1	1	X	X	Store Dcache hit and writable, done.
STx Memory	1	0	X	X	Store hit and not writable, set dirty flow (note 1).
STx Memory	0	X	1	1	Store Bcache hit and writable, done.
STx Memory	0	X	1	0	Store hit and not writable, set-dirty flow (note 1).
STx Memory	0	X	0	X	Miss, generate RdBlkMod command.
STx I/O	X	X	X	X	WrBytes, WrLWs, or WrQWs based on size.
STx_C Memory	0	X	X	X	Fail STx_C.
STx_C Memory	1	0	X	X	STx_C hit and not writable, set dirty flow (note 1).
STx_C I/O	X	X	X	X	Always succeed and WrQws or WrLws are generated, based on the size.
WH64 Memory	1	1	X	X	Hit, done.
WH64 Memory	1	0	X	X	WH64 hit not writable, set dirty flow (note 1).
WH64 Memory	0	X	1	1	WH64 hit dirty, done.
WH64 Memory	0	X	1	0	WH64 hit not writable, set dirty flow (note 1).
WH64 Memory	0	X	0	X	Miss, generate InvalToDirty command (note 2).
WH64 I/O	X	X	X	X	NOP the instruction. WH64 is UNDEFINED for I/O space.
ECB Memory	X	X	X	X	Generate evict command (note 3).
ECB I/O	X	X	X	X	NOP the instruction. ECB instruction is UNDEFINED for I/O space.
MB/WMB TBFill Flows	X	X	X	X	Generate MB command (note 4). Also see Section 3.2.5.

Physical Address Considerations

Table 4–1 notes:

1. **Set Dirty Flow:** Based on the Cbox CSR SET_DIRTY_ENABLE[2:0], SetDirty requests can be either internally acknowledged (called a SetModify) or sent to the system environment for processing. When externally acknowledged, the shared status information for the cache block is also broadcast. The commands sent externally are SharedToDirty or CleanToDirty. Based on the Cbox CSR ENABLE_STC_COMMAND[0], the external system can be informed of a STx_C generating a SetDirty using the STCChangeToDirty command. See Table 4–16 for more information.
2. **InvalToDirty:** Based on the Cbox CSR INVAL_TO_DIRTY_ENABLE[1:0], InvalToDirty requests can be either internally acknowledged or sent to the system environment as InvalToDirty commands. This Cbox CSR provides the ability to convert WH64 instructions to RdModx operations. See Table 4–15 for more information.
3. **Evict:** There are two aspects to the commands that are generated by an ECB instruction: first, those commands that are generated to notify the system of an evict being performed; second, those commands that are generated by any victim that is created by servicing the ECB.
 - If Cbox CSR ENABLE_EVICT[0] is clear, no command is issued by the 21264/EV68A on the external interface to notify the system of an evict being performed. If Cbox CSR ENABLE_EVICT[0] is set, the 21264/EV68A issues an Evict command on the system interface only if a Bcache index match to the ECB address is found in the 21264/EV68A cache system.

Note that whenever ENABLE_EVICT[0] is true (in the write-many chain), BC_CLEAN_VICTIM must also be true (in the write-once chain). Otherwise, the 21264/EV68A could respond miss to a probe, rather than hit, before an Evict command has been sent off chip, but after the Evict command has removed a (clean) block from the internal caches and the Bcache. That behavior might cause systems that maintain an external duplicate copy of the Bcache tags to become confused, because the system could receive the probe response indicating the miss before it receives the Evict command.
 - The 21264/EV68A can issue the commands CleanVictimBlk and WrVictimBlk for a victim that is created by an ECB. CleanVictimBlk is issued only if Cbox CSR BC_CLEAN_VICTIM is set and there is a Bcache index match valid but not dirty in the 21264/EV68A cache system. WrVictimBlk is issued for any Bcache match of the ECB address that is dirty in the 21264/EV68A cache system.
4. **MB:** Based on the Cbox CSR SYSBUS_MB_ENABLE, the MB command can be sent to the pins.

Each of these CSRs is programmed appropriately, based on the cache coherence protocol used by the system environment. For example, uniprocessor systems would prefer to internally acknowledge most of these transactions. In contrast, multiprocessor systems may require notification and control of any change in cache state. The 21264/EV68A and the external system must cooperate to maintain cache coherence. Section 4.5 explains the 21264/EV68A part of the cache coherency protocol.

4.3 Bcache Structure

The 21264/EV68A Cbox provides control signals and an interface for a second-level cache (Bcache).

The 21264/EV68A supports a Bcache from 1MB to 16MB, with 64-byte blocks. A 128-bit bidirectional data bus is used for transfers between the 21264/EV68A and the Bcache. The Bcache is fully synchronous and the synchronous static RAMs (SSRAMs) must contain either one, two, or three internal registers. All Bcache control and address pins are clocked synchronously on Bcache cycle boundaries. The Bcache clock rate varies as a multiple of the CPU clock cycle in half-cycle increments from 1.5 to 4.0, and in full-cycle increments of 5, 6, 7, and 8 times the CPU clock cycle. The 1.5 multiple is only available in dual-data mode.

4.3.1 Bcache Interface Signals

Figure 4–2 shows the 21264/EV68A system interface signals.

Figure 4–2 21264/EV68A Bcache Interface Signals

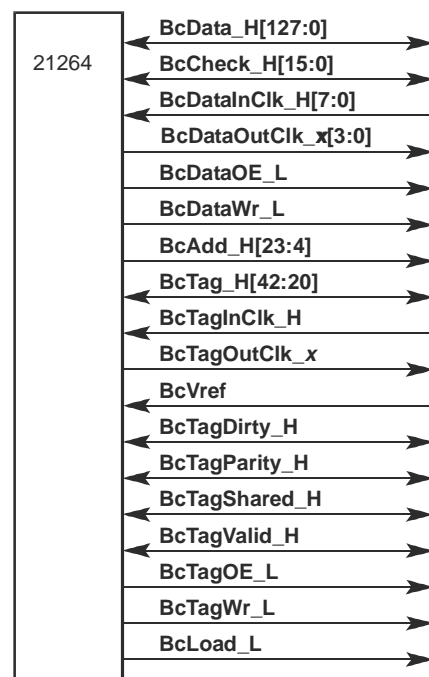

FM-05650

4.3.2 System Duplicate Tag Stores

The 21264/EV68A provides Bcache state support for systems with and without duplicate tag stores, and will take different actions on this basis. The system sets the Cbox CSR DUP_TAG_ENA[0], indicating that it has a duplicate tag store for the Bcache. Systems using the DUP_TAG_ENA[0] bit must also use the Cbox CSR BC_CLEAN_VICTIM[0] bit to avoid deadlock situations.

Systems using a Bcache duplicate tag store can accelerate system performance by:

Victim Data Buffer

- Issuing probes and SysDc fill commands to the 21264/EV68A out-of-order with respect to their order at the system serialization point
- Filtering out all probe misses from the 21264/EV68A cache system

If a probe misses in the 21264/EV68A cache system (Bcache miss and VAF miss), the 21264/EV68A stalls probe processing with the expectation that a SysDc fill will allocate this block. Because of this, in duplicate tag mode, the 21264/EV68A can never generate a probe miss response.

When Cbox CSR DUP_TAG_ENA[0] equals 0, the 21264/EV68A delivers a miss response for probes that do not hit in its cache system.

4.4 Victim Data Buffer

The 21264/EV68A has eight victim data buffers (VDBs). They have the following properties:

- The VDBs are used for both victims (fills that are replacing dirty cache blocks) and for system probes that require data movement. The CleanVictimBlk command (optional) assigns and uses a VDB.
- Each VDB has two valid bits that indicate the buffer is valid for a victim or valid for a probe or valid for both a victim and a probe. Probe commands that match the address of a victim address file (VAF) entry with an asserted probe-valid bit (P) will stall the 21264/EV68A probe queue. No ProbeResponses will be returned until the P bit is clear.
- The release victim buffer (RVB) bit, when asserted, causes the victim valid bit, on the victim data buffer (VDB) specified in the ID field, to be cleared. The RVB bit will also clear the IOWB when systems move data on I/O write transactions. In this case, ID[3] equals one.
- The release probe buffer (RPB) bit, when asserted (with a WriteData or Release-Buffer SysDc command), clears the P bit in the victim buffer entry specified in the ID field.
- Read data commands and victim write commands use IDs 0-7, while IDs 8-11 are used to address the four I/O write buffers.

4.5 Cache Coherency

This section describes the basics and protocols of the 21264/EV68A cache coherency scheme.

4.5.1 Cache Coherency Basics

The 21264/EV68A systems maintain the cache hierarchy shown in Figure 4–3.

Figure 4–3 Cache Subset Hierarchy

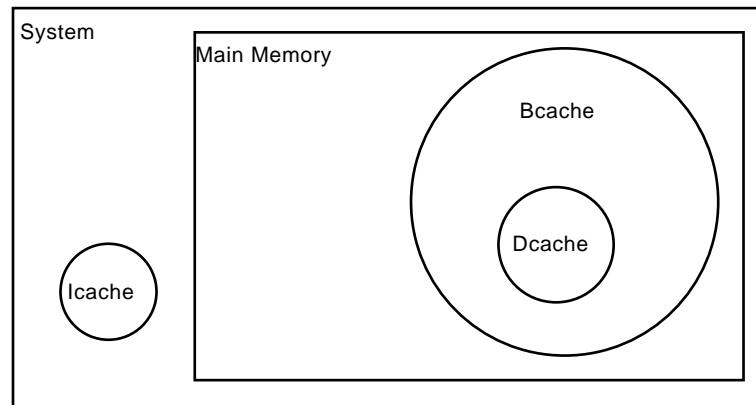

FM-05824.A14

The following tasks must be performed to maintain cache coherency:

- Istream data from memory spaces may be cached in the Icache and Bcache. Icache coherence is not maintained by hardware—it must be maintained by software using the CALL_PAL IMB instruction.
- The 21264/EV68A maintains the Dcache as a subset of the Bcache. The Dcache is set-associative but is kept a subset of the larger externally implemented direct-mapped Bcache.
- System logic must help the 21264/EV68A to keep the Bcache coherent with main memory and other caches in the system.
- The 21264/EV68A requires the system to allow only one change to a block at a time. This means that if the 21264/EV68A gains the bus to read or write a block, no other node on the bus should be allowed to access that block until the data has been moved.
- The 21264/EV68A provides hardware mechanisms to support several cache coherency protocols. The protocols can be separated into two classes: write invalidate cache coherency protocol and flush cache coherency protocol.

4.5.2 Cache Block States

Table 4–2 lists the cache block states supported by the 21264/EV68A.

Table 4–2 21264/EV68A-Supported Cache Block States

State Name	Description
Invalid	The 21264/EV68A does not have a copy of the block.
Clean	This 21264/EV68A holds a read-only copy of the block, and no other agent in the system holds a copy. Upon eviction, the block is not written to memory.

Table 4–2 21264/EV68A-Supported Cache Block States (Continued)

State Name	Description
Clean/Shared	This 21264/EV68A holds a read-only copy of the block, and at least one other agent in the system may hold a copy of the block. Upon eviction, the block is not written to memory.
Dirty	This 21264/EV68A holds a read-write copy of the block, and must write it to memory after it is evicted from the cache. No other agent in the system holds a copy of the block.
Dirty/Shared	This 21264/EV68A holds a read-only copy of the dirty block, which may be shared with another agent. The block must be written back to memory when it is evicted.

4.5.3 Cache Block State Transitions

Cache block state transitions are reflected by 21264/EV68A-generated commands to the system. Cache block state transitions can also be caused by system-generated commands to the 21264/EV68A (probes). Probes control the next state for the cache block. The next state can be based on the previous state of the cache block. Table 4–3 lists the next state for the cache block.

Table 4–3 Cache Block State Transitions

Next State	Action Based on Probe Hit
No change	Do not update cache state. Useful for DMA transactions that sample data but do not want to update tag state.
Clean	Independent of previous state, update next state to Clean.
Clean/Shared	Independent of previous state, update next state to Clean/Shared. This transaction is useful for systems that update memory on probe hits.
T1: Clean ⇒ Clean/Shared Dirty ⇒ Dirty/Shared	Based on the dirty bit, make the block clean or dirty shared. This transaction is useful for systems that do not update memory on probe hits.
T3: Clean ⇒ Clean/Shared Dirty ⇒ Invalid Dirty/Shared ⇒ Clean/Shared	If the block is Clean or Dirty/Shared, change to Clean/Shared. If the block is Dirty, change to Invalid. This transaction is useful for systems that use the Dirty/Shared state as an exclusive state.

The cache state transitions caused by 21264/EV68A-generated commands are under the full control of the system environment using the SysDc (system data control) commands. Table 4–4 lists these commands.

Table 4–4 System Responses to 21264/EV68A Commands

Response Type	21264/EV68A Action
SysDc ReadData	Fill block with the associated data and update tag with clean cache status.
SysDc ReadDataDirty	Fill block with the associated data and update tag with dirty cache status.
SysDc ReadDataShared	Fill block with the associated data and update tag with shared cache status.
SysDc ReadDataShared/Dirty	Fill block with the associated data and update tag with dirty/shared status.
SysDc ReadDataError	Fill block with all-ones reference pattern and update tag with invalid status.
SysDc ChangeToDirtySuccess	Unconditionally update block with dirty cache status.
SysDc ChangeToDirtyFail	Do not update cache status and fail any associated STx_C instructions.

4.5.4 Using SysDc Commands

Note the following:

- The conventional response for RdBlk commands is SysDc ReadData or ReadDataShared.
- The conventional response for a RdBlkMod command is SysDc ReadDataDirty.
- The conventional response for ChangeToDirty commands is ChangeToDirtySuccess or ChangeToDirtyFail.

However, the system environment is not limited to these responses. Table 4–5 shows all 21264/EV68A commands, system responses, and the 21264/EV68A reaction. The 21264/EV68A commands are described in the following list:

- Rdx commands are generated by load or Istream references.
- RdBlkModx commands are generated by store references.
- The ChxToDirty command group includes CleanToDirty, SharedToDirty, and STC-ChangeToDirty commands, which are generated by store references that hit in the 21264/EV68A cache system.
- InvalToDirty commands are generated by WH64 instructions that miss in the 21264/EV68A cache system.
- FetchBlk and FetchBlkSpec are noncached references to memory space that have missed in the 21264/EV68A cache system.
- Rdiox commands are noncached references to I/O address space.
- Evict and STCChangeToDirty commands are generated by ECB and STx_C instructions, respectively.

Table 4–5 shows the system responses to 21264/EV68A commands and 21264/EV68A reactions.

Table 4–5 System Responses to 21264/EV68A Commands and Reactions

21264/EV68A CMD	SysDc	21264/EV68A Action
Rdx	ReadData ReadDataShared	This is a normal fill. The cache block is filled and marked clean or shared based on SysDc.
Rdx	ReadDataShared/Dirty	The cache block is filled and marked dirty/shared. Succeeding store commands cannot update the block without external reference.
Rdx	ReadDataDirty	The cache block is filled and marked dirty.
Rdx	ReadDataError	The cache block access was to NXM address space. The 21264/EV68A delivers an all-ones pattern to any load command and evicts the block from the cache (with associated victim processing). The cache block is marked invalid.
Rdx	ChangeToDirtySuccess ChangeToDirtyFail	Both SysDc responses are illegal for read commands.

Cache Coherency

Table 4–5 System Responses to 21264/EV68A Commands and Reactions (Continued)

21264/EV68A CMD	SysDc	21264/EV68A Action
RdBlkModx	ReadData ReadDataShared ReadDataShared/Dirty	The cache block is filled and marked with a nonwritable status. If the store instruction that generated the RdBlkModx command is still active (not killed), the 21264/EV68A will retry the instruction, generating the appropriate ChangeToDirty command. Succeeding store commands cannot update the block without external reference.
RdBlkModx	ReadDataDirty	The 21264/EV68A performs a normal fill response, and the cache block becomes writable.
RdBlkModx	ChangeToDirtySuccess ChangeToDirtyFail	Both SysDc responses are illegal for read/modify commands.
RdBlkModx	ReadDataError	The cache block command was to NXM address space. The 21264/EV68A delivers an all-ones pattern to any dependent load command, forces a fail action on any pending store commands to this block, and any store to this block is not retried. The Cbox evicts the cache block from the cache system (with associated victim processing). The cache block is marked invalid.
ChxToDirty	ReadData ReadDataShared ReadDataShared/Dirty	The original data in the Dcache is replaced with the filled data. The block is not writable, so the 21264/EV68A will retry the store instruction and generate another ChxToDirty class command. To avoid a potential livelock situation, the STC_ENABLE CSR bit must be set. Any STx_C instruction to this block is forced to fail. In addition, a Shared/Dirty response causes the 21264/EV68A to generate a victim for this block upon eviction.
ChxToDirty	ReadDataDirty	The data in the Dcache is replaced with the filled data. The block is writable, so the store instruction that generated the original command can update this block. Any STx_C instruction to this block is forced to fail. In addition, the 21264/EV68A generates a victim for this block upon eviction.
ChxToDirty	ReadDataError	Impossible situation. The block must be cached to generate a ChxToDirty command. Caching the block is not possible because all NXM fills are filled noncached.
ChToDirty	ChangeToDirtySuccess	Normal response. ChangeToDirtySuccess makes the block writable. The 21264/EV68A retries the store instruction and updates the Dcache. Any STx_C instruction associated with this block is allowed to succeed.
ChxToDirty	ChangeToDirtyFail	The MAF entry is retired. Any STx_C instruction associated with the block is forced to fail. If a STx instruction generated this block, the 21264/EV68A retries and generates either a RdBlkModx (because the reference that failed the ChangeToDirty also invalidated the cache by way of an invalidating probe) or another ChxToDirty command.
InvalToDirty	ReadData ReadDataShared ReadDataShared/Dirty	The block is not writable, so the 21264/EV68A will retry the WH64 instruction and generate a ChxToDirty command.
InvalToDirty	ReadDataError	The 21264/EV68A doesn't send InvalToDirty commands offchip speculatively. This NXM condition is a hard error. Systems should perform a machine check.
InvalToDirty	ReadDataDirty ChangeToDirtySuccess	The block is writable. Done.

Table 4–5 System Responses to 21264/EV68A Commands and Reactions (Continued)

21264/EV68A CMD	SysDc	21264/EV68A Action
InvalToDirty	ChangeToDirtyFail	Illegal. InvalToDirty instructions must provide a cache block.
Fetchx Rdiox	ReadData ReadDataShared ReadDataShared/Dirty ReadDataDirty	The 21264/EV68A delivers the data block, independent of its status, to waiting load instructions and does not cache the block in the 21264/EV68A cache system.
Fetchx	ReadDataError	The cache block address was to an NXM address space. The 21264/EV68A delivers the all-ones patterns to any dependent load instructions and does not cache the block in the 21264/EV68A cache system.
Rdiox	ReadDataError	The cache block access was to NXM address space. The 21264/EV68A delivers an all-ones pattern to any load command and does not cache the block in the 21264/EV68A cache system.
Evict	ChangeToDirtyFail	Retiring the MAF entry is the only legal response.
STCChangeTo Dirty	ReadDataX ChangeToDirtyFail	All fill and ChangeToDirtyFail responses will fail the STx_C requirements.
STCChangeTo Dirty	ChangeToDirtySuccess	The STx_C instruction succeeds.
MB	MBDone	Acknowledgment for MB.

The 21264/EV68A sends a WrVictimBlk command to the system when it evicts a Dirty or Dirty/Shared cache block. The 21264/EV68A may be configured to send a CleanVictimBlk to the system (by way of the Cbox CSR BC_CLEAN_VICTIM[0]) when evicting a clean or shared block. Both commands allocate buffers in the VAF (victim address file). This buffer is a coherent part of the 21264/EV68A cache system. Write data control and deallocation of the VAF can be directly controlled by using the SysDc Write-Data and ReleaseBuffer commands.

4.5.5 Dcache States and Duplicate Tags

Each Dcache block contains an extra state bit (modified bit), beyond those required to support the cache protocol. If set, this bit indicates that the associated block should be written to the Bcache when it is evicted from the Dcache. The modified bit is set in two cases:

1. When a block is filled into the Dcache from memory its modified bit is set, ensuring that it also gets written back into the Bcache at some future time.
2. When the processor writes to a dirty Dcache block the modified bit is set, indicating it should be written to the Bcache when evicted.

The contents of the modified bit are functionally invisible to the external cache environment, but knowledge of the bits function is useful to programmers optimizing the scheduling of the Bcache data bus.

The Cbox contains a duplicate copy of the Dcache tag array. In contrast to the Dcache tag array (DTAG), which is virtually indexed, the Cbox copy of the Dcache tag array (CTAG) is physically-indexed. The Cbox uses the CTAG array entries in the following situations.

Lock Mechanism

1. When the Mbox requests a Dcache fill, the Cbox uses the CTAG array entry to find if the Dcache already contains the requested physical address in another virtually-indexed Dcache line. If it does, the Cbox invalidates that cache line after first writing the data back to the Bcache if it was in the modified state. The Cbox also checks to see if the Dcache contains an address different from the requested address, but maps to the same Bcache line. If it does, the Dcache line is evicted in order to keep the Dcache a subset of the Bcache.
2. When the Ibox requests an Icache fill, the Cbox uses the CTAG array entries to find if the Dcache contains the requested physical address in the modified state. If it does, the Cbox forces the line to be written back to the Bcache before servicing the Icache fill request. The Cbox also checks to see if the Dcache contains an address different from the requested address but which maps to the same Bcache line. In this case the Istream request will miss the Bcache, and the Cbox will service the request by launching a noncached Fetch command to the system port and will not put the Istream block into the Bcache. This mechanism allows the 21264/EV68A to use a cache resident lock flag for LDx_L/STx_C instructions.
3. The Cbox uses the CTAG array entries to find whether probe addresses are held in the Dcache without interrupting load/store instruction processing in the processor core.

4.6 Lock Mechanism

The 21264/EV68A does not contain a dedicated lock register, nor are system components required to do so.

When a load-lock (LDx_L) instruction executes, data is accessed from the Dcache or Bcache. If there is a cache miss, data is accessed from memory with a RdBlk command. Its associated cache line is filled into the Dcache in the clean state, if it is not already there.

When the store-conditional (STx_C) instruction executes, it is allowed to succeed if its associated cache line is still present in the Dcache and can be made writable; otherwise, it fails.

This algorithm is successful because another agent in the system writing to the cache line between the load-lock and the store-conditional cache line would make the cache line invalid. This mechanism's coherence is based on the following four items:

1. LDx_L instructions are processed in-order in relation to the associated STx_C.
2. Once a block is locked by way of an LDx_L instruction, no internal agent can evict the block from the Dcache as a side-effect of its processing.
3. Any external agent that intends to update the contents of the stored block must use an invalidating probe command to inform the 21264/EV68A.
4. The system is the only agent with sufficient information to manage the tasks of fairness and liveness. However, to enable these tasks, the 21264/EV68A only generates external commands for nonspeculative STx_C instructions, and once given a success indication from the system, must faithfully update the Dcache with the STx_C value.

The system is entirely responsible for item number three. The 21264/EV68A plays an active role in items one, two, and four.

4.6.1 In-Order Processing of LD_x_L/ST_x_C Instructions

The 21264/EV68A uses the stWait logic in the IQ to ensure that LD_x_L/ST_x_C pairs are issued in order. The stWait logic treats an Ldx_L instruction like Stx instructions. ST_x_C instructions are always loaded into the IQ with their associate stWait bit set. Thus, a ST_x_C instruction is not issued until the older LD_x_L is out of the IQ.

4.6.2 Internal Eviction of LD_x_L Blocks

The 21264/EV68A prevents the eviction of cache blocks in the Dcache due to either of the following references:

- Istream references with a Bcache index that matches the Dcache block and a Bcache tag that mismatches the Dcache block.

To avoid evictions of LD_x_L blocks, Istream references that match the index of a block in the Dcache are converted to noncached references.

- Ldx or Stx references with a Dcache index that matches the block.

In the Alpha architecture, Dstream references between a LD_x_L/ST_x_C pair force the value of the ST_x_C success flag to be UNPREDICTABLE. The 21264/EV68A forces all ST_x_C instructions that interrupt an LD_x_L/ST_x_C pair to fail in program order.

There should be no Dstream references between LD_x_L/ST_x_C pairs; however, the out-of-order nature of the 21264/EV68A can introduce Dstream references between LD_x_L/ST_x_C pairs. To prevent load or store instructions older than the LD_x_L from evicting the LD_x_L cache block, the Mbox invokes a replay trap on the incoming load or store instruction, which also aborts the LD_x_L. These instructions are issued in program order in the next iteration of the trap retry down the pipeline. To prevent newer load or store instructions from evicting the locked cache line, the Ibox ensures that a ST_x_C is issued before any newer load or store instruction by placing the ST_x_C into the IQ and stalling all subsequent instructions in the map stage of the pipe until the IQ is empty.

Branch instructions between the LD_x_L/ST_x_C pair may be mispredicted, introducing load and store instructions that evict the locked cache block. To prevent that from happening, there is a bit in the instruction fetcher that is set for a LD_x_L reference and cleared on any other memory reference. When this bit is set, the branch predictor predicts all branches to fall through.

4.6.3 Liveness and Fairness

To prevent a livelock condition, the 21264/EV68A processes the ST_x_C as follows:

1. If a ST_x_C misses the Dcache, then no system port transaction is started and the ST_x_C fails.
2. If a ST_x_C hits a block that is not dirty, then a ChangeToDirty (Shared or Clean) is launched after the ST_x_C retires and all older store queue entries are in the writable state. This ensures that once the ChangeToDirty command is launched on behalf of the ST_x_C, the ST_x_C will be executed to completion if the ChangeToDirty command succeeds.

System Port

If the ChangeToDirty command succeeds, the STx_C enters the writable state, and the Mbox locks the Dcache line. The Mbox does not release the Dcache line until the STx_C data is transferred to the Dcache. This ensures that no other agent, by way of a probe, can take the block before the STx_C can update the locked block.

4.6.4 Managing Speculative Store Issues with Multiprocessor Systems

The 21264/EV68A provides two mechanisms to manage an inherent potential side effect of speculative execution with multiprocessor systems — a livelock condition caused by a speculative store that misses in one processor affecting the execution of a LDx_L/STx_C pair in another processor. The potential livelock condition in multiprocessor systems can be effectively controlled by placing processors in a conservative mode, where speculative store MAFs are blocked. The 21264/EV68A manages conservative mode with the Mbox IPR, M_CTL[SMC], described in Table 5–19.

- M_CTL[SMC] can be set to place the 21264/EV68A in full-time conservative mode.
- M_CTL[SMC] can be set to place the 21264/EV68A in periodic conservative mode, timed by two counters: an 8-bit primary counter that tracks branch mispredicts and conditional branch retires, and a backup counter that places the 21264/EV68A in conservative mode for a period of 16K cycles every 2 million cycles.

The 8-bit counter is enabled by placing M_CTL[SMC] in periodic conservative mode. The backup counter takes effect whenever the 8-bit counter is enabled. Further, the backup counter can be reset to 0 by clearing a previously set M_CTL[SMC], allowing synchronization between processors.

4.7 System Port

The system port is the 21264/EV68A's connection to either a memory or I/O controller or to a shared multiprocessor system controller. System port interface signals are shown in Figure 4–4.

The system port supports transactions between the 21264/EV68A and the system. Systems must receive and drive signals that are asserted low. Transaction commands are communicated on signal lines **SysAddOut_L[14:0]** (21264/EV68A-to-system) and **SysAddIn_L[14:0]** (system-to-21264/EV68A). Transaction data is transferred on a bidirectional data bus over pins **SysData_L[63:0]** with ECC on pins **SysCheck_L[7:0]**.

Figure 4–4 System Interface Signals

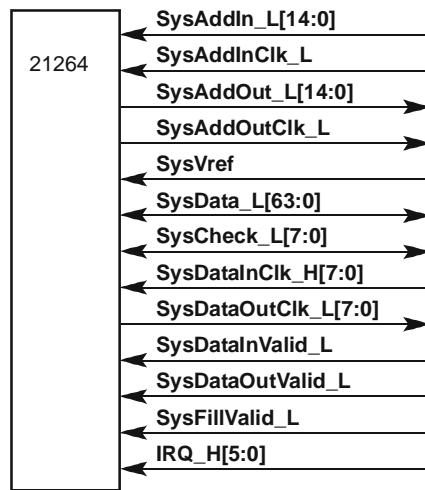

FM-05652-EV67

4.7.1 System Port Pins

Table 3–1 defines the 21264/EV68A signal types referred to in this section. Table 4–6 lists the system port pin groups along with their type, number, and functional description.

Table 4–6 System Port Pins

Pin Name	Type	Count	Description
IRQ_H[5:0]	I_DA	6	These six interrupt signal lines may be asserted by the system.
SysAddIn_L[14:0]	I_DA	15	Time-multiplexed SysAddIn, system-to-21264/EV68A.
SysAddInClk_L	I_DA	1	Single-ended forwarded clock from system for SysAddIn_L[14:0] and SysFillValid_L .
SysAddOut_L[14:0]	O_OD	15	Time-multiplexed SysAddOut, 21264/EV68A-to-system.
SysAddOutClk_L	O_OD	1	Single-ended forwarded clock.
SysVref	I_DC_REF	1	System interface reference voltage.
SysCheck_L[7:0]	B_DA_OD	8	Quadword ECC check bits for SysData_L[63:0] .
SysData_L[63:0]	B_DA_OD	64	Data bus for memory and I/O data.
SysDataInClk_H[7:0]	I_DA	8	Single-ended system-generated clocks for clock forwarded input system data.
SysDataInValid_L	I_DA	1	When asserted, marks a valid data cycle for data transfers to the 21264/EV68A.
SysDataOutClk_L[7:0]	O_OD	8	Single-ended 21264/EV68A-generated clocks for clock forwarded output system data.
SysDataOutValid_L	I_DA	1	When asserted, marks a valid data cycle for data transfers from the 21264/EV68A.
SysFillValid_L	I_DA	1	Validation for fill given in previous SysDc command.

4.7.2 Programming the System Interface Clocks

The system forwarded clocks are free running and derived from the 21264/EV68A GCLK. The period of the system forwarded clocks is controlled by three Cbox CSRs, based on the bit-rate ratio (similar to the Bcache bit-rate ratio) except that all transfers are dual-data.

- SYS_CLK_LD_VECTOR[15:0]
- SYS_BPHASE_LD_VECTOR[3:0]
- SYS_FDBK_EN[7:0]

Table 4–7 lists the programming values used to program the system interface clocks.

Table 4–7 Programming Values for System Interface Clocks

System Transfer	SYS_CLK_LD_VECTOR ¹	SYS_BPHASE_LD_VECTOR ¹	SYS_FDBK_EN ¹
1.5X-DD	9249	5	02
2.0X-DD	3333	0	01
2.5X-DD	8C63	5	02
3.0X-DD	71C7	0	10
3.5X-DD	C387	A	04
4.0X-DD	0F0F	0	01
5.0X-DD	7C1F	0	40
6.0X-DD	F03F	0	10
7.0X-DD	C07F	0	04
8.0X-DD	00FF	0	01

¹ These are hexadecimal values.

In addition to programming of the clock CSRs, the data-sample/drive Cbox CSRs at the pads have to be set appropriately. Table 4–8 shows the programmed values for these system CSRs. In Table 4–8, each system forwarded clock is the inversion of the low-assertion signal at the corresponding pin.

Table 4–8 Program Values for Data-Sample/Drive CSRs

CBOX CSR	Description
SYS_DDM_FALL_EN[0]	Enables the update of 21264/EV68A system outputs based on the falling edge of the system forwarded clock. (Always asserted)
SYS_DDM_RISE_EN[0]	Enables the update of 21264/EV68A system outputs based on the rising edge of the system forwarded clock. (Always asserted)
SYS_DDM_RD_FALL_EN[0]	Enables the sampling of incoming data on the falling edge of the incoming forwarded clock. (Always asserted)

Table 4–8 Program Values for Data-Sample/Drive CSRs (Continued)

CBOX CSR	Description
SYS_DDM_RD_RISE_EN[0]	Enables the sampling of incoming data on the rising edge of the incoming forwarded clock. (Always asserted)
SYS_DDMF_ENABLE	Enables the falling edge of the system forwarded clock. (Always asserted)
SYS_DDMR_ENABLE	Enables the rising edge of the system forwarded clock. (Always asserted)

Table 4–9 lists the program values for CSR SYS_FRAME_LD_VECTOR[4:0] that set the ratio between the forwarded clocks and the frame clock.

Table 4–9 Forwarded Clocks and Frame Clock Ratio

Clock Ratio	Transfer Mode	Value ¹
1:1	All	00
2:1	3.0X, 3.5X, 8.0X	1E
2:1	1.5X, 2.0X, 2.5X 4.0X, 5.0X, 6.0X 7.0X	1F
4:1	8X	15
4:1	1.5X, 4.0X, 5.0X, 6.0X, 7.0X	0B
4:1	3.0X, 3.5X	14
4:1	2.0X, 2.5X	0A

¹ These are hexadecimal values.

4.7.3 21264/EV68A-to-System Commands

This section describes the 21264/EV68A-to-system commands format and operation. The command, address, ID, and mask bits are transmitted in four consecutive cycles on **SysAddOut_L[14:0]**. The 21264/EV68A sends the command information in one of the two following modes as selected by the Cbox CSR bit.

- Bank interleave on cache block boundary mode—SYSBUS_FORMAT[0] = 0
- Page hit mode—SYSBUS_FORMAT[0] = 1

The physical address (PA) bits arrangements for the two modes is shown in Tables 4–10 and 4–11. The purpose of the two modes is to give the system the PA bits that allow it to select the memory bank and drive the RAS address as soon as possible.

4.7.3.1 Bank Interleave on Cache Block Boundary Mode

Table 4–10 shows the command format for the bank interleave on cache block boundary mode of operation (21264/EV68A-to-system).

Table 4–10 Bank Interleave on Cache Block Boundary Mode of Operation

	SysAddOut_L[14:2]		SysAddOut_L[1]	SysAddOut_L[0]
Cycle 1	M1	Command[4:0]	PA[34:28]	PA[36]
				PA[38]

Table 4–10 Bank Interleave on Cache Block Boundary Mode of Operation (Continued)

	SysAddOut_L[14:2]				SysAddOut_L[1]	SysAddOut_L[0]
Cycle 2	PA[27:22], PA[12:6]				PA[35]	PA[37]
Cycle 3	M2	Mask[7:0]	CH	ID[2:0]	PA[40]	PA[42]
Cycle 4	RV	PA[21:13], PA[5:3]			PA[39]	PA[41]

4.7.3.2 Page Hit Mode

Table 4–11 shows the command format for page hit mode (21264/EV68A-to-system).

Table 4–11 Page Hit Mode of Operation

	SysAddOut_L[14:2]				SysAddOut_L[1]	SysAddOut_L[0]
Cycle 1	M1	Command[4:0]	PA[31:25]		PA[32]	PA[33]
Cycle 2	PA[24:12]				PA[11]	PA[34]
Cycle 3	M2	Mask[7:0]	CH	ID[2:0]	PA[35]	PA[37]
Cycle 4	RV	PA[34:32], PA[11:3]			PA[36]	PA[38]

Table 4–12 describes the field definitions for Tables 4–10 and 4–11.

Table 4–12 21264/EV68A-to-System Command Fields Definitions

SysAddOut Field	Definition
M1	When set, reports a miss to the system for the oldest probe. When clear, has no meaning.
Command[4:0]	The 5-bit command field is defined in Table 4–14.
SysAddOut[1:0]	This field is needed for systems with greater than 32GB of memory, up to a maximum of 8 Terabyte (8TB). Cost-focused systems can tie these bits high and use a 13-bit command/address field.
M2	When set, reports that the oldest probe has missed in cache. Also, this bit is set for system-to-21264/EV68A probe commands that hit but have no data movement (see the CH bit, below). When clear, has no meaning. M1 and M2 are not asserted simultaneously. Reporting probe results as soon as possible is critical to high-speed operation, so when a result is known the 21264/EV68A uses the earliest opportunity to send an M signal to the system. M bit assertion can occur either in a valid command or a NZNOP.
ID[2:0]	The ID number for the MAF, VDB, or WIOB associated with the command.
RV	If set, validates this command. In speculative read mode (optional), RV = 1 validates the command and RV = 0 indicates a NOP. For all nonspeculative commands RV = 1.
Mask[7:0]	The byte, LW, or QW mask field for the corresponding I/O commands.
CH	The cache hit bit is asserted, along with M2, when probes with no data movement hit in the Dcache or Bcache. This response can be generated by a probe that explicitly indicates no data movement or a ReadIfDirty command that hits on a valid but clean or shared block.

System designers can minimize pin count for systems with a small memory by configuring both the bank interleave on cache block boundary mode and the page hit mode formats into a *short bus* format. The pin **SysAddOut_L[1]** and/or **SysAddOut_L[0]** are not used (selected by Cbox CSR SYS_BUS_SIZE[1:0]). Table 4–13 lists the values for SYSBUS_FORMAT and SYS_BUS_SIZE[1:0] and shows the maximum physical memory size.

Table 4–13 Maximum Physical Address for Short Bus Format

SYSBUS_FORMAT	SYSBUS_SIZE[1:0]	Maximum PA	Comment
0	00	42	Bank interleave + full address
0	01	36	Bank interleave + SysAddOut_L[0] unused
0	10	Illegal	Illegal combination
0	11	34	Bank interleave + both SysAddOut_L[1:0] are used for I/O
1	00	38	Page hit mode + full address
1	01	36	Page hit mode + SysAddOut_L[0] unused
1	10	Illegal	Illegal combination
1	11	34	Page hit mode + both SysAddOut_L[1:0] are unused

Because addresses above the maximum PA are not visible to the external system, any memory transaction generated to addresses above the maximum PA are detected and converted to transactions to NXM (nonexistent memory) and processed internally by the 21264/EV68A.

4.7.4 21264/EV68A-to-System Commands Descriptions

Table 4–14 describes the 21264/EV68A-to-system commands.

Table 4–14 21264/EV68A-to-System Commands Descriptions

Command	Command [4:0]	Function
NOP	00000	The 21264/EV68A drives this command on idle cycles during reset. After the clock forward reset period, the first NZNOP is generated and this command is no longer generated.
ProbeResponse	00001	Returns probe status and ID number of the VDB entry holding the requested cache block.
NZNOP	00010	This nonzero NOP helps to parse the command packet.
VDBFlushRequest	00011	VDB flush request. The 21264/EV68A sends this command to the system when an internally generated transaction Bcache index matches a Bcache victim or probe in the VDB. The system should flush VDB entries associated with all probe and WrVictimBlk transactions that occurred before this command.
MB ¹	00111	Indicates an MB was issued, optional when Cbox CSR SYSBUS_MB_ENA[0] is set.
ReadBlk	10000	Memory read.

Table 4–14 21264/EV68A-to-System Commands Descriptions (Continued)

Command	Command [4:0]	Function
ReadBlkMod	10001	Memory read with modify intent.
ReadBlkI	10010	Memory read for Istream.
FetchBlk	10011	Noncached memory read.
ReadBlkSpec ²	10100	Speculative memory read (optional).
ReadBlkModSpec ²	10101	Speculative memory read with modify intent (optional).
ReadBlkSpecI ²	10110	Memory read for Istream (optional).
FetchBlkSpec ²	10111	Speculative memory noncached ReadBlk (optional).
ReadBlkVic ³	11000	Memory read with a victim (optional).
ReadBlkModVic ³	11001	Memory read with modify intent, with a victim (optional).
ReadBlkVicI ³	11010	Memory read for Istream with a victim (optional).
WrVictimBlk	00100	Write-back of dirty block.
CleanVictimBlk	00101	Address of a clean victim (optional).
Evict ⁴	00110	Invalidate evicted block at the given Bcache index (optional).
ReadBytes	01000	I/O read, byte mask.
ReadLWs	01001	I/O read, longword mask.
ReadQWs	01010	I/O read, quadword mask.
WrBytes	01100	I/O write, byte mask.
WrLWs	01101	I/O write, longword mask.
WrQWs	01110	I/O write, quadword mask.
CleanToDirty ⁶	11100	Sets a block dirty that was previously clean (optional for duplicate tags).
SharedToDirty ⁶	11101	Sets a block dirty that was previously shared (optional for multiprocessor systems).
STCChangeToDirty ⁶	11110	Sets a block dirty that was previously clean or shared for a STx_C instruction (optional for multiprocessor systems).
InvalToDirtyVic ^{3,5}	11011	Invalid to dirty with a victim (optional).
InvalToDirty ⁵	11111	WH64 Acts like a ReadBlkMod without the fill cycles (optional).

Table 4–14 footnotes:

1. Systems can optionally enable MB instructions to the external system by asserting Cbox CSR SYSBUS_MB_ENABLE. This mode is described in Section 2.12.1.
2. To minimize load-to-use memory latency, systems can optionally enable speculative transactions to memory space by asserting the Cbox CSR SPEC_READ_ENABLE[0]. If the Cbox system command queue is empty, a bypass between the Bcache interface and the system interface is enabled (in combination with this mode). When the next new transaction is delivered by the Mbox, the Cbox starts MAF memory references to the system interface before the results of Bcache hit is known. The RV bit is deasserted on a Bcache hit, or in BC_RDVICTIM[0] mode (see footnote 3, below), and for Bcache miss transactions that generate a victim (clean or dirty). Otherwise, the RV bit is asserted.
3. Systems can optionally enable RdBlkVic, RdBlkModVic, and InvalToDirtyVic commands using Cbox CSR BC_RDVICTIM[0]. In this mode of operation RdBlk x Vic command cycles are always followed immediately by the WrVictimBlk commands. Also, when CleanVictimBlk commands are enabled, they immediately follow RdBlkVic, RdBlkModVic, and InvalToDirtyVic commands.
4. Systems can optionally enable Evict commands by asserting the Cbox CSR ENABLE_EVICT. In this mode, all ECB instructions will generate an Evict command, and in combination with BC_RDVICTIM[0] mode, the WriteVictim or CleanVictim (when Cbox CSR BC_CLEAN_VICTIM[0] is asserted) is associated with the Evict command is atomically sent after the Evict command.
5. Optionally, systems can enable InvalToDirty commands by programming Cbox CSR INVAL_TO_DIRTY_ENABLE[1:0]. Table 4–15 shows how to program INVAL_TO_DIRTY_ENABLE[1:0].
6. Optionally, systems can enable CleanToDirty or SharedToDirty commands by using Cbox CSR SET_DIRTY_ENABLE[2:0]. These three bits control the Cbox action upon a block that was hit in the Dcache with a status of dirty/shared, clean/shared, or clean respectively.

Table 4–15 Programming INVAL_TO_DIRTY_ENABLE[1:0]

INVAL_TO_DIRTY_ENABLE[1:0]	Cbox Action
X0	WH64 instructions are converted to RdModx commands at the interface. Beyond this point, no other agent sees the WH64 instruction. This mode is useful for microprocessors that do not want to support InvalToDirty transactions.
01	WH64 instructions are enabled, but they are acknowledged within the 21264/EV68A.
11	WH64 instructions are enabled, and generate InvalToDirty transactions at the 21264/EV68A pins.

Table 4–16 Programming SET_DIRTY_ENABLE[2:0]

SET_DIRTY_ENABLE [2,0] (DS,CS,C)	Cbox Action
000	Everything acknowledged internally (uniprocessor).
001	Only clean blocks generate external acknowledge (CleanToDirty commands only).
010	Only clean/shared blocks generate external acknowledge (SharedToDirty command only).
011	Clean and clean/shared blocks generate external acknowledge.
100	Only dirty/shared blocks generate external acknowledge (SharedToDirty commands only).
101	Only dirty/shared and clean blocks generate external acknowledge.
110	Only dirty/shared and clean/shared blocks generate external acknowledge.
111	All transactions generate external acknowledge.

Systems that require an explicit indication of ChangeToDirty status changes initiated by STx_C instructions can assert Cbox CSR STC_ENABLE[0]. When this register field = 000, CleanToDirty and SharedToDirty commands are used. The distinction between a ChangeToDirty command generated by a STx_C instruction and one generated by a STx instruction is important to systems that want to service ChangeToDirty commands with dirty data from a source processor. In this case, the distinction between a locked exclusive instruction and a normal instruction is critical to avoid livelock for a LDx_L/STx_C sequence.

4.7.5 ProbeResponse Commands (Command[4:0] = 00001)

The 21264/EV68A responds to system probes that did not miss with a 4-cycle transfer on SysAddOut_L[14:0]. As shown in Table 4–14, the Command[4:0] field for a ProbeResponse command equals 00001. Table 4–17 shows the format of the 21264/EV68A ProbeResponse command.

Table 4–17 21264/EV68A ProbeResponse Command

	SysAddOut_L[14:2]						SysAddOut_L[1]	SysAddOut_L[0]
Cycle 1	0	00001	Status[1:0]	DM	VS	VDB [2:0]	X	X
Cycle 2	0				MS	MAF [2:0]	X	X
Cycle 3	0	X					X	X
Cycle 4	X						X	X

Table 4–18 describes the ProbeResponse command fields.

Table 4–18 ProbeResponse Fields Descriptions

ProbeResponse Field	Description										
Command[4:0]	The value 00001 identifies the command as a ProbeResponse.										
DM	Indicates that data movement should occur (copy of probe valid bit). See Section 4.4.										
VS	Write victim sent bit.										
VDB[2:0]	ID number of the VDB entry containing the requested cache block. This field is valid when either the DM bit or the VS bit equals 1.										
MS	MAF address sent.										
MAF[2:0]	This field indicates the SharedToDirty, CleanToDirty, or STCChangetoDirty MAF entry that matched the full probe address.										
Status[1:0]	Result of probe: <table border="1"> <thead> <tr> <th>Status[1:0]</th> <th>Probe state</th> </tr> </thead> <tbody> <tr> <td>00</td> <td>HitClean</td> </tr> <tr> <td>01</td> <td>HitShared</td> </tr> <tr> <td>10</td> <td>HitDirty</td> </tr> <tr> <td>11</td> <td>HitSharedDirty</td> </tr> </tbody> </table>	Status[1:0]	Probe state	00	HitClean	01	HitShared	10	HitDirty	11	HitSharedDirty
Status[1:0]	Probe state										
00	HitClean										
01	HitShared										
10	HitDirty										
11	HitSharedDirty										

The system uses the SysDc signal lines to retrieve data for probes that requested a cache block from the 21264/EV68A. See Section 4.7.7.2 for more information about 2-cycle data transfer commands. Probes that respond with M1, M2, or CH=1 will not be reported to the system in a probe response command.

4.7.6 SysAck and 21264/EV68A-to-System Commands Flow Control

Controlling the flow of 21264/EV68A-to-system commands is a joint task of the 21264/EV68A and the system. The flow is controlled using the A bit, which is asserted by the system, and the Cbox CSR SYSBUS_ACK_LIMIT[4:0] counter. The counter has the following properties:

- The 21264/EV68A increments its command-outstanding counter when it sends a command to the system. The 21264/EV68A decrements the counter by one each time the A bit (**SysAddIn_L[14]**) is asserted in a system-to-21264/EV68A command. The A bit is transmitted during cycle four of a probe mode command or during cycle two of a SysDc command.
- The 21264/EV68A stops sending new commands when the counter hits the maximum count specified by Cbox CSR SYSBUS_ACK_LIMIT[4:0]. When this counter is programmed to zero, the CMD_ACK count is ignored (unlimited commands are allowed in-flight).
- Because RdBlk_xVic and WrVictimBlk commands are atomic when the CSR BC_RDVICTIM[0] is set, the 21264/EV68A does not send a RdBlk_xVic command if the SYSBUS_ACK_LIMIT[4:0] is equal to one less than the maximum outstanding count. The limit cannot be programmed with a value of one when RdBlk_xVic commands are enabled unless the Cbox CSR RDVIC_ACK_INHIBIT command is also asserted (see Table 5–24).

- There is no mechanism for the system to reject a 21264/EV68A-to-system command. ProbeResponse, VDBFlushReq, NOP, NZNOP, and RdBlkxSpec (with a clear RV bit) commands do not require a response from the system. Systems must provide adequate resources for responses to all probes sent to the 21264/EV68A.
- Systems that program the Cbox CSR BC_RDVICTIM[0] to immediately follow victim write transactions with read transactions and allocate combined resources for the pair, may find it useful to increment the SYSBUS_ACK_LIMIT[4:0] counter only once for the pair. These systems may assert Cbox CSR RDVIC_ACK_INHIBIT, which does not increment the SYSBUS_ACK_LIMIT[4:0] count for RdBlkVic, RdBlkModVic, and RdBlkVicI commands.
- Systems that maintain victim data buffers may find it useful to limit the number of outstanding WrVictimBlk commands. This can be accomplished by using the Cbox CSR SYSBUS_VIC_LIMIT[2:0]. When the number of outstanding WrVictim commands or CleanVictim commands reaches this programmed limit, the Cbox stops generating victim commands on the system port. Because victim and read commands are atomic when BC_RDVICTIM[0] = 1, the RdBlkxVic commands are stalled when the victim limit is reached. Programming the SYSBUS_VIC_LIMIT[2:0] to zero disables this limit.

4.7.7 System-to-21264/EV68A Commands

The system can send either probes (4-cycle) or data movement (2-cycle) commands to the 21264/EV68A. Signal pin **SysAddIn_L[14]** in the first command cycle indicates the type of command being sent (1 = probe, 0 = data transfer). Sections 4.7.7.1 and 4.7.7.2 describe the formats of the two types of commands.

4.7.7.1 Probe Commands (Four Cycles)

Probes are always 4-cycle commands that contain a field to indicate a valid SysDc command. The format of the 4-cycle command is shown below.

Note: The **SysAddIn_L[1:0]** signal lines are optional and are used for memory designs greater than 32GB. The position of the address bits matches the selected format of the SysAddOut bus. The example below shows the bank interleave format.

Table 4–19 shows the format of the system-to-21264/EV68A probe commands.

Table 4–19 System-to-21264/EV68A Probe Commands

	SysAddIn_L[14:2]				SysAddIn_L[1]	SysAddIn_L[0]
Cycle 1	1	Probe[4:0]		PA[34:28]	PA[36]	PA[38]
Cycle 2	PA[27:22], PA[12:6]				PA[35]	PA[37]
Cycle 3	0	SysDc[4:0]	RVB	RPB	A	ID[3:0]
Cycle 4	C	PA[21:13], PA[5:3]			PA[39]	PA[41]

Table 4–20 describes the system-to-21264/EV68A probe commands fields descriptions.

Table 4–20 System-to-21264/EV68A Probe Commands Fields Descriptions

SysAddIn_L[14:0]	
Field	Description
Probe[4:0]	Probe type and next tag state (see Tables 4–21 and 4–22).
SysDc[4:0]	Controls data movement in and out of the 21264/EV68A. See Table 4–24 for a list of data movement types.
RVB	Clears the victim or I/O write buffer (IOWB) valid bit specified in ID[3:0].
RPB	Clears probe valid bit specified in ID[2:0].
A	Command acknowledge. When set, the 21264/EV68A decrements its command outstanding counter (SYSBUS_ACK_LIMIT[4:0]).
ID[3:0]	Identifies the victim data buffer (VDB) number or the I/O write buffer (IOWB) number. Bit [3] is only asserted for the IOWB.
C	Commit bit. This bit decrements the uncommitted event counter (MB_CNTR) used for MB acknowledge.

The probe command field Probe[4:0] has two sections, Probe[4:3] and Probe[2:0].

Table 4–21 lists the data movement selected by Probe[4:3].

Table 4–21 Data Movement Selection by Probe[4:3]

Probe[4:3]	Data Movement Function
00	NOP
01	Read if hit, supply data to system if block is valid.
10	Read if dirty, supply data to system if block is valid/dirty.
11	Read anyway, supply data to the system at index of probe.

Table 4–22 lists the next cache block state selected by Probe[2:0].

Table 4–22 Next Cache Block State Selection by Probe[2:0]

Probe[2:0]	Next Tag State
000	NOP
001	Clean
010	Clean/Shared
011	Transition ³ ₁ : Clean ⇒ Clean/Shared Dirty ⇒ Invalid Dirty/Shared ⇒ Clean/Shared
100	Dirty/Shared

Table 4–22 Next Cache Block State Selection by Probe[2:0] (Continued)

Probe[2:0]	Next Tag State
101	Invalid
110	Transition1 ² : Clean ⇒ Clean/Shared Dirty ⇒ Dirty/Shared
111	Reserved

¹ Transition3 is useful in nonduplicate tag systems that want to give writable status to the reader and do not know if the block is clean or dirty.

² Transition1 is useful in nonduplicate tag systems that do not update memory on ReadBlk hits to a dirty block in another processor.

The 21264/EV68A holds pending probe commands in a 8-entry deep probe queue. The system must count the number of probes that have been sent and ensure that the probes do not overrun the 21264/EV68A queue. The 21264/EV68A removes probes from the internal probe queue when the probe response is sent.

The 21264/EV68A expects to hit in cache on a probe response, so it always fetches a cache block from the Bcache on system probes. This can become a performance problem for systems that do not monitor the Bcache tags, so the 21264/EV68A provides Cbox CSR PRB_TAG_ONLY[0], which only accesses Bcache tags for system probes. For a Bcache hit, the 21264/EV68A retries the probe reference to get the associated data. In this mode, the 21264/EV68A has a cache-hit counter that maintains some history of past cache hits in order to fetch the data with the tag in the cases where streamed transactions are being performed to the host processor.

4.7.7.2 Data Transfer Commands (Two Cycles)

Data transfer commands use a 2-cycle format on **SysAddIn_L[14:0]**. The SysDc[4:0] field indicates success or failure for ChangeToDirty and MB commands, and error conditions as shown in Table 4–24.

The pattern of data is controlled by the **SysDataInValid_L** and **SysDataOutValid_L** signals. These signals are valid each cycle of data transfer, indicating any gaps in the data cycle pattern. The **SysDataInValid_L** and **SysDataOutValid_L** signals are described in Section 4.7.8.4. Table 4–23 shows the format of the data transfer command.

Table 4–23 Data Transfer Command Format

	SysAddIn_L[14:2]						SysAddIn_L[1]	SysAddIn_L[0]
Cycle 1	0	SysDc[4:0]	RVB	RPB	A	ID[3:0]	X	X
Cycle 2	C	X					X	X

Table 4–24 describes the SysDc[4:0] field.

Table 4–24 SysDc[4:0] Field Description

SysDc[4:0] Command	SysDc[4:0]	Description
NOP	00000	NOP, SysData is ignored by the 21264/EV68A.
ReadDataError	00001	Data is returned for read commands. The system drives the SysData bus, I/O, or memory NXM.
ChangeToDirtySuccess	00100	No data. SysData is ignored by the 21264/EV68A. This command is also used for the InvalToDirty response.
ChangeToDirtyFail	00101	No data. SysData is ignored by the 21264/EV68A. This command is also used for the Evict response.
MBDone	00110	Memory barrier operation completed.
ReleaseBuffer	00111	Command to alert the 21264/EV68A that the RVB, RPB, and ID field are valid.
ReadData (System Wrap)	100xx	Data returned for read commands. The system drives SysData. The system uses SysDc[1:0] to control the wrap order. See Section 4.7.8.6 for a description of the data wrapping scheme.
ReadDataDirty (System Wrap)	101xx	Data is returned for Rdx and RdModx commands. The ending tag status is dirty. The system uses SysDc[1:0] to define the wrap order.
ReadDataShared (System Wrap)	110xx	Data is returned for read commands. The system drives the data. The tag is marked shared. The system uses SysDc[1:0] to control the wrap order.
ReadDataShared/Dirty (System Wrap)	111xx	Data is returned for the RdBlk command. The ending tag status is Shared/Dirty. The system uses SysDc[1:0] to control the wrap order.
WriteData	010xx	Data is sent for 21264/EV68A write commands or system probes. The 21264/EV68A drives during the SysData cycles. The lower two bits of the command specify the octaword address around which the 21264/EV68A wraps the data.

The A bit in the first cycle indicates that the command is acknowledged. When A = 1, the 21264/EV68A decrements its command outstanding counter, but the A bit is not necessarily related to the current SysDc command.

Probe commands can combine a SysDc command along with MBDone. In that event, the probe is considered ahead of the SysDc command. If the SysDc command allows the 21264/EV68A to retire an instruction before an MB, or allows the 21264/EV68A itself to retire an MB (SysDc is MBDone), that MB will not complete until the probe is executed.

The system can select the ending cache status for a cache fill operation by specifying the status in one of the following SysDc commands:

ReadData (Clean)	ReadDataShared (Clean/Shared)
ReadDataDirty (Dirty)	ReadDataShared/Dirty (Shared/Dirty)

The system returns ReadDataShared or ReadData for ReadBlk commands, and ReadDataDirty for a ReadMod command. However, other combinations are possible, but should be used only after a careful study of the situation.

The `ChangeToDirtySuccess` and `ChangeToDirtyFail` commands cannot be issued in the shadow of `SysDc` cache fill commands (`ReadDataError`, `ReadData`, `ReadDataDirty`, `ReadDataShared`, and `ReadDataShared/Dirty`). Each cache fill command allocates eight cycles on the `SysData` bus. Systems are required to ensure that any future `SysDc` commands do not cause conflicts with those eight `SysData` bus cycles. In addition, the system must not issue `ChangeToDirtySuccess` or `ChangeToDirtyFail` commands in the six `SysAddrIn` cycles after any of the `ReadData`x commands because doing so will overload internal MAF resources in the 21264/EV68A.

Because of an internal 21264/EV68A constraint, a minimum memory latency of $4 \times \text{BCACHE_CLK_PERIOD}$ is imposed. This latency is measured from A3 of the outgoing command (the last cycle) to the delivery of the `SysDc` command to the processor.

4.7.8 Data Movement In and Out of the 21264/EV68A

There are two modes of operation for data movement in and out of the 21264/EV68A: fast mode and fast mode disable. The data movement mode is selected using `Cbox CSR FAST_MODE_DISABLE[0]`. Fast data mode allows movement of data from the 21264/EV68A to bypass protocol and achieve the lowest possible latency for probe's data, write victim data, and I/O write data. Rules and conditions for the two modes are listed and described in Sections 4.7.8.2 and 4.7.8.3. Before discussing data movement operation, 21264/EV68A clock basics are described in Section 4.7.8.1.

4.7.8.1 21264/EV68A Clock Basics

The 21264/EV68A uses a clock forwarding technique to achieve very high bandwidth on its pin interfaces. The clock forwarding technique has three main principles:

1. Local point-to-point transfers can be made safely, and at very high bandwidth, if the sender can provide the receiver with a forward clock (`FWD_CLK`) to latch the transmitted data at the receiver.
 - The `SysAddOutClk_L` and `SysDataOutClk_L[7:0]` pins provide the forwarding clocks for transfers out of the 21264/EV68A.
 - The `SysAddInClk_L` and `SysDataInClk_H[7:0]` pins provide the forwarding clocks for transfers into the 21264/EV68A.
2. If only one state element was used to capture the transmitted data, and the skew between the two clock systems was greater than the bit-rate of the transfer, the data valid time of the transmitted data would not be sufficient to safely transfer the latched data into the receiver's clock domain. In order to avoid this problem, the receiver provides a queue that is manipulated in the transmitter's time domain. Using this queue, the data valid window of the transmitted data is extended (to an arbitrary size based on the queue size), and the transfer to the receiver's clock domain can be safely made by delaying the unloading of this queue element beyond the skew between the two clock domains. The internal clock that unloads this queue is labelled `INT_FWD_CLK`. `INT_FWD_CLK` is timed at both the rising and falling edges of the external clock, thus appearing to run at twice the external clock's frequency.
3. The first two points provide the steady state basis for clock forwarded transfers; however, both the sender and receiver must be correctly initialized to enable coherent and predictable transfers. This clock initialization is performed during system initialization using the `ClkFwdRst_H` and `FrameClk_H` signals.

If both the sender and the receiver are sampling at the same rate, these three principles are sufficient to safely make point-to-point transfers using clock forwarding. However, it is often desirable for systems to align clock-forwarded transactions on a slower SYSCLK that is the basis of all non-processor system transactions.

The 21264/EV68A supports three ratios for SYSCLK to INT_FWD_CLK: one-to-one (1-1), two-to-one (2-1), and four-to-one (4-1). Using one of these ratios, the 21264/EV68A starts transactions on SYSCLK boundaries. This ratio is programmed into the 21264/EV68A using the Cbox CSR SYS_FRAME_LD_VECTOR[4:0]. This ratio is independent of the frequency of **FrameClk_H**.

For data movement, the 21264/EV68A reacts to SysDc commands when they are resolved into the 21264/EV68A's clock domain. This occurs when the 21264/EV68A's INT_FWD_CLK unloads the SysDc command from the clock forwarding queue. This moment is determined by the amount of delay programmed into the clock forwarding silo (by way of Cbox CSR SYS_RCV_MUX_CNT_PRESET[1:0]). Thus, all the timing relationships are relative to this unload point in time, which will be referred to as the point the command is perceived by 21264/EV68A.

4.7.8.2 Fast Data Mode

The 21264/EV68A is the default driver of the bidirectional SysData bus¹. As the 21264/EV68A is processing WrVictim, ProbeResponse (only the hit case), and IOWB commands to the system, accompanying data is made available at the clock-forwarded bus.

Because there is a bandwidth difference between address (4 cycles) and data (8 cycles) transfers, the 21264/EV68A tries to fully use fast data mode by delaying the next SysAddOut write command until a fast data mode slot is available on the SysDataOut bus.

SysDc commands (cache fill or explicit write commands) that collide with the fast data on the SysData bus have higher priority, and so may interrupt the successful completion of the fast transfer. Systems are responsible for detecting and replaying all interrupted fast transfers. There are no gaps in a fast transfer and no data wrapping (the first cycle contains QW0, addressed by PA[5:3] = 000).

The system must release victim buffers, and probe buffers and IOWB entries by sending a SysDc command with the appropriate RVB/RPB bit for both successful fast data transfers and for transfers that have been replayed. Fast data transfers have two parts:

1. SysAddOut command with the probe response, WrVictim, or Wr(I/O)
2. Data

The command precedes data by at least one SYSCLK period. Table 4–25 shows the number of SYSCLK cycles between SysAddOut and SysData for all system clock ratios (clock forwarded bit times) and system framing clock multiples.

¹ The SysData bus contains SysData_L[63:0] and SysCheck_L[7:0].

Table 4–25 SYSCLK Cycles Between SysAddOut and SysData

System framing clock ratio	GCLK/INT_FWD_CLK (Data Rate Ratio)									
	1.5X	2.0X	2.5X	3.0X	3.5X	4.0X	5.0X	6.0X	7.0X	8.0X
1	4	3	2	2	2	2	1	1	1	1
2	2	2	1	1	1	1	1	1	1	1
4	1	1	1	1	1	1	1	1	1	1

Figure 4–5 show a simple example of a fast transfer. The data rate ratio is 1.5X with a 4:1 SYSCLK to INT_FWD_CLK ratio.

Figure 4–5 Fast Transfer Timing Example

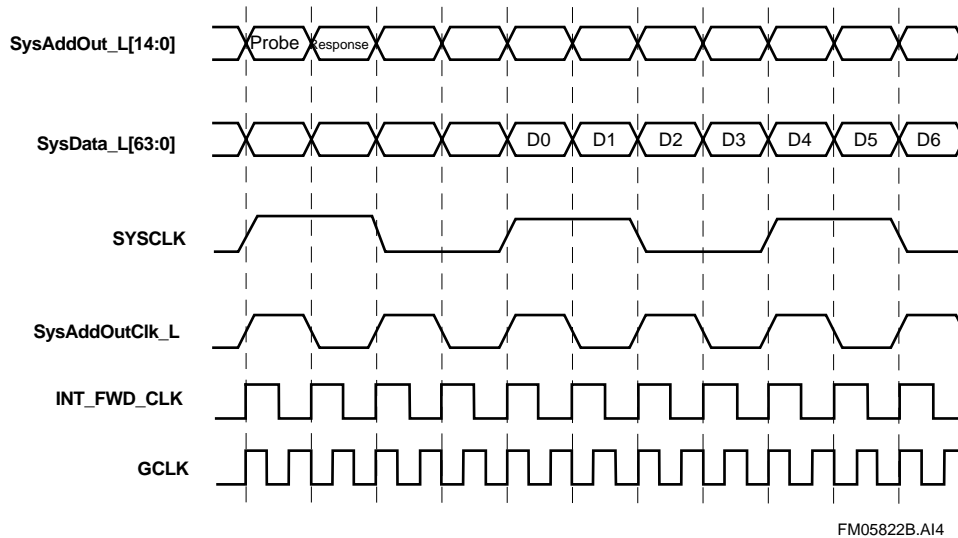

FM05822B.AI4

In fast data mode, movement of data into the 21264/EV68A requires turning around the SysData bus that is being actively driven by the 21264/EV68A. Given a SysDc fill command (ReadDataError, ReadData, ReadDataShared, ReadDataShared/Dirty, ReadDataDirty), the 21264/EV68A responds as follows:

1. Three GCLK cycles after perceiving the SysDc fill command, the 21264/EV68A turns off its drivers, interrupting any ongoing fast data write transactions.
2. The 21264/EV68A drivers stay off until the last piece of fill data is received, or a new SysDc write command overrides the current SysDc fill command. It is the responsibility of the external system to schedule SysDc fill or write commands so that there is no conflict on the SysData bus.
3. The 21264/EV68A samples fill data in the GCLK clock domain, 10 + SYSDC_DELAY GCLK cycles after perceiving the SysDc fill command. The Cbox CSR SYSDC_DELAY[4:0] provides GCLK granularity for precisely placing fills into the processor pipeline discussed in Section 2.2.

Table 4–26 shows four example configurations and shows their use of the SYSDC_DELAY[4:0].

Table 4–26 Cbox CSR SYSDC_DELAY[4:0] Examples

System	Bit Rate	System Framing Clock Ratio ¹	SYSDC_DELAY
System 1	1.5X	4:1	5 (3 SYSCLK cycles)
System 2	2.0X	2:1	2 (3 SYSCLK cycles)
System 3	2.5X	2:1	0 (2 SYSCLK cycles)
System 4	4X	2:1	6 (2 SYSCLK cycles)

¹ The system framing clock ratio is the number of INT_FWD_CLK cycles per SYSCLK cycles.

System 1 has six GCLKs to every SYSCLK and only sends 4-cycle commands to the 21264/EV68A. Thus, a period of three SYSCLKs between the SysDc command and data leaves a period of 15 GCLKs between SysDc and data (SysDc is in the middle of the 4-cycle command). A SYSDC_DELAY[4:0] of five would align sampling and receipt of SysData.

System 2 has four GCLKs in every SYSCLK, so leading data by three SYSCLK cycles, and programming the SYSDC_DELAY[4:0] to two, aligns sampling and receiving.

Timing for systems 3 and 4 is derived in a similar manner.

Note: The maximum valid value for SYSDC_DELAY must be less than the minimum number of GCLK cycles between two consecutive SYSDC commands to the 21264/EV68A.

If a fast data transfer is interrupted and fails to complete, the system must use the conventional protocol to send a SysDc WriteData command to the 21264/EV68A, removing the desired data buffer. Section 4.7.8.3 describes the timing events for transferring data from the 21264/EV68A to the system.

4.7.8.3 Fast Data Disable Mode

The system controls all data movement to and from the 21264/EV68A. Movement of data into and out of the 21264/EV68A is preceded by a SysDc command. The 21264/EV68A drivers are only enabled for the duration of an 8-cycle transfer of data from the 21264/EV68A to the system. Systems must ensure that there is no overlap of enabled drivers and that there is adequate settle time on the SysData bus.

Given a SysDc fill command, the 21264/EV68A samples data $10 + \text{SYSDC_DELAY}$ GCLK cycles after the command is perceived within the 21264/EV68A clock domain. Because there is no linkage with the output driver, fills into the 21264/EV68A are not affected by the SYS_RCV_MUX_PRESET[1:0] value.

In both modes, given a SysDc write command, the 21264/EV68A looks for the next SYSCLK edge 8.5 cycles after perceiving the SysDc write command in its clock domain. Because the SysDc write command must be perceived before its use, SysDc write commands are dependent upon the amount of delay introduced by Cbox CSR SYS_RCV_MUX_CNT_PRESET[1:0].

Table 4–27 lists information for the four timing examples. In Table 4–27, note the following:

- SysDc write commands are not affected by the SYSDC_DELAY parameter.
- The SYS_RCV_MUX_PRESET adds delay at the rate of one INT_FWD_CLK at a time. For example, adding the delay of one bit time to system 1 adds 1.5 GCLK cycles to the delay and drives the SysDc write command-to-data relationship from one to two SYSCLKs.
- For write transfers, the 21264/EV68A drivers are enabled on the preceding GCLK BPHASE, before the start of a write transfer, and disabled on the succeeding GCLK BPHASE at the end of the write transfer. The write data is enveloped by the 21264/EV68A drivers to guarantee that every data transfer has the same data valid window.

Table 4–27 Four Timing Examples

System	Bit Rate	System Framing Clock Ratio ¹	Write Data
System 1	1.5X	4:1	2 SYSCLKs
System 2	2.0X	2:1	3 SYSCLKs
System 3	2.5X	2:1	2 SYSCLKs
System 4	4X	2:1	2 SYSCLKs

¹ The system framing clock ratio is the number of INT_FWD_CLK cycles per SYSCLK cycles.

The four examples described here assume no skew for the 2.0X and 4.0X cases and one bit time of skew for the 1.5X and 2.5X cases.

For system 1, the distance between SysDc and the first SYSCLK is nine GCLK cycles but the additional delay of one bit time (1.5 GCLKs) puts the actual delay after perceiving the SysDc command to 7.5 GCLKS, which misses the 8.5 cycle constraint. Therefore, the 21264/EV68A drives data two SYSCLKs after receiving the SysDc write command.

For system two, the distance between SysDc and the second SYSCLK is eight GCLK cycles, which also misses the 8.5 cycle constraint, so the 21264/EV68A drives data three SYSCLK cycles after receiving the SysDc write command (12 cycles).

The other two cases are derived in a similar manner.

4.7.8.4 SysDataInValid_L and SysDataOutValid_L

The SysDataValid signals (**SysDataInValid_L** and **SysDataOutValid_L**) are driven by the system and control the rate of data delivery to and from the 21264/EV68A.

SysDataInValid_L

The **SysDataInValid_L** signal controls the flow of data into the 21264/EV68A, and may be used to introduce an arbitrary number of cycles between octaword transfers into the 21264/EV68A. The rules for using **SysDataInValid_L** follow:

1. The **SysDataInValid_L** signal must be asserted for both cycles of a SysDc fill command, and two quadwords of data must be delivered to the 21264/EV68A in succeeding bit-clock cycles with the appropriate timing in reference to the SysDc fill command (SYSDC_DELAY + 10 CPU cycles).
2. Any number of bubble cycles can be introduced within the fill by deasserting **SysDataInValid_L** between octaword transfers.
3. The transfer of fill data can continue by asserting **SysDataInValid_L** for at least two bit-clock cycles, and delivering data SYSDC_DELAY + 10 CPU cycles after the assertion of **SysDataInValid_L**.
4. The 21264/EV68A must see **SysDataInValid_L** asserted for eight data cycles in order to complete a fill. When the eighth cycle of an asserted **SysDataInValid_L** is perceived by the 21264/EV68A, the transfer is complete.
5. Systems that do not use **SysDataInValid_L** may tie the pin to the asserted state.

If SYSDC_DELAY is greater than the bit-time of a transfer, the **SysDataInValid_L** signal must be internally pipelined. To enable the correct sampling of **SysDataInValid_L**, the 21264/EV68A provides a delay, with Cbox CSR DATA_VALID_DELAY[1:0], that is equal to SYSDC_DELAY[4:0]/bit-time. For example, consider system 1 in Table 4–26, which has a SYSDC_DELAY of five GCLKs. Running at a bit-time of 1.5X, the DATA_VALID_DELAY[1,0] is programmed with a value of three.

SysDataOutValid_L

Systems that use a ratio of 1:1 for SYSCLK:INT_FWD_CLK may control the flow of data out of the 21264/EV68A by using **SysDataOutValid_L** as follows:

1. The **SysDataOutValid_L** pin must be asserted for at least the first cycle of the SysDc write command that initiates a write transfer.
2. Any number of bubble cycles may be introduced between quadword transfers by deasserting **SysDataOutValid_L**.
3. The 21264/EV68A must see the **SysDataOutValid_L** signal asserted for eight data cycles to complete a write transaction, and when the eighth cycle of an asserted **SysDataOutValid_L** is perceived by the 21264/EV68A, the transfer is complete.

4.7.8.5 SysFillValid_L

The **SysFillValid_L** pin, when asserted, validates the current memory and I/O data transfer into the 21264/EV68A. The system designer may tie this pin to the asserted state (validating all fills), or use it to enable or cancel fills as they progress. The 21264/EV68A samples **SysFillValid_L** at D1 time (when the 21264/EV68A samples the second data cycle).

If **SysFillValid_L** is asserted at D1 time, the fill will continue uninterrupted. If it is not asserted, the 21264/EV68A cancels the fill, but expects all eight QWs of data to arrive at its system bus before continuing to the next fill. Also, the 21264/EV68A maintains the state of the MAF, expecting another valid fill to the same MAF entry. Figure 4–6 illustrates **SysFillValid_L** timing.

Figure 4–6 SysFillValid_L Timing

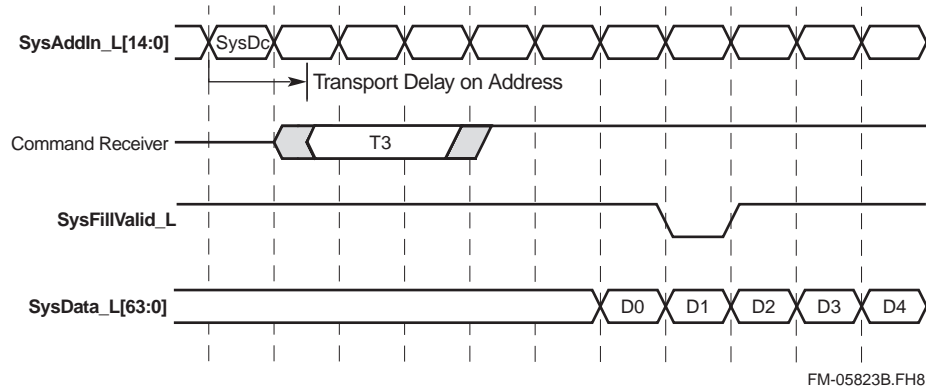

FM-05823B.FH8

4.7.8.6 Data Wrapping

All data movement between the 21264/EV68A and the system is composed of 64 bytes in eight cycles on the data bus. All 64 bytes of memory data are valid. This applies to memory read transactions, memory write transactions, and system probe read transactions. The wrap order is interleaved. The internal data bus, which delivers data to the functional units and the Dcache, is 16 bytes wide, and so, no transfers happen until two data cycles occur on the interface.

Table 4–28 lists the rules for data wrapping. I/O read and write addresses on the SysAddOut bus point to the desired byte, word, LW, or QW, with a combination of SysAddOut_L[5:3] and the mask field [7:0].

Table 4–28 Data Wrapping Rules

Command	Significant Address Bits	Mask Type	Rules
ReadQW and WrQW	SysAddOut_L[5:3]	QW	SysAddOut_L[5:3] contains the exact PA bits of the first LDQ or STQ to the block. The mask bits point to the valid QWs merged in ascending order.
ReadLW and WrLW	SysAddOut_L[5:3]	LW	SysAddOut_L[5:3] contain the exact PA bits of the first LDL or STL to the block. The mask bits point to the valid LWs merged in ascending order within one hexword.
LDByte/Word and STByte/Word	SysAddOut_L[5:3]	Byte	SysAddOut_L[5:3] contain the exact QW PA bits of the LDByte/Word or STByte/Word instruction. The mask bits point to the valid byte in the QW.

The order in which data is provided to the 21264/EV68A (for a memory or I/O fill) or moved from the 21264/EV68A (write victims or probe reads) can be determined by the system. The system chooses to reflect back the same low-order address bits and the corresponding octaword found in the SysAddOut field or the system chooses any other starting point within the block.

SysDc commands for the ReadData, ReadDataShared, and WriteData groups require that systems define the position of the first QW by inserting the appropriate value of SysAddOut_L[5:3] into bits [1:0] of the command field. The recommended starting

point is the QW pointed to by the 21264/EV68A; however, some systems may find it more beneficial to begin the transfer elsewhere. The system must always indicate the starting point to the 21264/EV68A. The wrap order for subsequent QWs is interleaved.

Table 4–29 defines the method for systems to specify wrap and deliver data.

Table 4–29 System Wrap and Deliver Data

Source/ Destination	SysDc[4:2]	SysDc[1:0]	Size	Rules
Memory	100 (ReadData)	SysAddOut_L[5:4]	Block (64 Bytes)	See Note 1
Memory	101(ReadDataDirty)	SysAddOut_L[5:4]	Block (64 Bytes)	See Note 1
Memory	110 (ReadDataShared)	SysAddOut_L[5:4]	Block (64 Bytes)	See Note 1
Memory	111(Read DataShared/Dirty)	SysAddOut_L[5:4]	Block (64 Bytes)	See Note 1
Memory	010 (WriteData)	SysAddOut_L[5:4]	Block (64 Bytes)	See Note 1
I/O	100 (ReadData)	SysAddOut_L[5:4]	QW (8-64 Bytes)	See Note 1
I/O	100 (ReadData)	SysAddOut_L[4:3]	LW(4-32 Bytes)	See Note 2
I/O	100 (ReadData)	SysAddOut_L[4:3]	Byte/Word	See Note 2
I/O	010 (WriteData)	SysAddOut_L[5:4]	QW (8-64 Bytes)	See Note 1
I/O	010 (WriteData)	SysAddOut_L[5:4]	LW(4-32 Bytes)	See Note 1
I/O	010 (WriteData)	SysAddOut_L[5:4]	Byte/Word	See Note 1

Note 1: Transfers to and from the 21264/EV68A have eight data cycles for a total of eight quadwords. The starting point is defined by the system. The preferred starting point is the one pointed to by **SysAddOut_L[5:4]**. Systems can insert the **SysAddOut_L[5:4]** into the **SysDc[1:0]** field of the command. See Table 4–30 for the wrap order.

Note 2: LW and byte/word read transfers differ from all other transfers. The system unloads only four QWs of data into eight data cycles by sending each QW twice (referred to as double-pumped data transfer). The first QW returned is determined by **SysAddOut_L[4:3]**. The system again may elect to choose its own starting point for the transfer and insert that value into **SysDc[1:0]**. See Table 4–31 for the wrap order.

Table 4–30 defines the interleaved scheme for the wrap order.

Table 4–30 Wrap Interleave Order

	PA Bits [5:3] of Transferred QW			
First quadword	000	010	100	110
Second quadword	001	011	101	111
Third quadword	010	000	110	100
Fourth quadword	011	001	111	101
Fifth quadword	100	110	000	010

Table 4–30 Wrap Interleave Order (Continued)

	PA Bits [5:3] of Transferred QW			
Sixth quadword	101	111	001	011
Seventh quadword	110	100	010	000
Eighth quadword	111	101	011	001

Table 4–31 defines the wrap order for double-pumped data transfers.

Table 4–31 Wrap Order for Double-Pumped Data Transfers

	PA [5:3] of Transferred QW			
First quadword	x00	x01	x10	x11
Second quadword	x00	x01	x10	x11
Third quadword	x01	x00	x11	x10
Fourth quadword	x01	x00	x11	x10
Fifth quadword	x10	x11	x00	x01
Sixth quadword	x10	x11	x00	x01
Seventh quadword	x11	x10	x01	x00
Eighth quadword	x11	x10	x01	x00

4.7.9 Nonexistent Memory Processing

Like its predecessors, the 21264/EV68A can generate references to nonexistent (NXM) memory or I/O space. However, unlike the earlier Alpha microprocessor implementations, the 21264/EV68A can generate speculative references to memory space. To accommodate the speculative nature of the 21264/EV68A, the system must not generate or lock error registers because of speculative references. The 21264/EV68A translates all memory references through the translation lookaside buffer (TLB) and, in some cases, the 21264/EV68A may generate speculative references (instruction execution down mispredicted paths) to NXM space. In these cases, the system sends a SysDc ReadDataError and the 21264/EV68A does the following:

- Delivers an all-ones pattern to all load instructions to the NXM address
- Force-fails all store instructions to the NXM address (much like a STx_C failure)
- Invalidates the cache block at the same index by way of an atomic Evict command

Table 4–32 shows each 21264/EV68A command, with NXM addresses, and the appropriate system response.

Table 4–32 21264/EV68A Commands with NXM Addresses and System Response

21264/EV68A Command NXM Address	System/21264/EV68A Response
ProbeResponse	Probe responses for addresses to NXM space are of UNPREDICTABLE status. Although the final status of a ReadDataError is Invalid, the 21264/EV68A fills the block Valid/Clean and uses an atomic Evict command to invalidate the block. Systems that send probes to NXM space to the 21264/EV68A must disregard the probe result.
RdBlk RdBlkSpec RdBlkVic	Load references to NXM space can be speculative. In this case, systems should respond with a SysDc ReadDataError fill that the 21264/EV68A uses to service the original load/Istream command. If the original load command was speculative, the 21264/EV68A will remove the load instruction that generated the NXM command, and start processing instructions down the correctly predicted path. If the command was not speculative, there must be an error in the operating system mapping of a virtual address to an illegal physical address, and the 21264/EV68A provides an all ones pattern as a signature for this bug. The NXM block is not cached in the Dcache or Bcache.
RdBlkI RdBlkSpecI RdBlkVicI	Istream references to NXM space can be speculative. In this case, systems should respond with a SysDc ReadDataError fill, which the 21264/EV68A will use to service and execute the original Istream reference. If the original Istream reference was speculative, the 21264/EV68A will remove the instructions started after the mispredicted instruction that generated the NXM reference, and start instruction processing down the correctly predicted path. If the reference was not speculative, there must be an error in the operating system mapping of a virtual address to an illegal physical address, and the 21264/EV68A provides an all ones pattern as a signature for this bug. The NXM block is not cached in the Bcache, but can be cached in the Icache.
RdBlkMod RdBlkModSpec RdBlkModVic	Store instructions to NXM space initiate RdBlkMod commands. Again, speculative store instructions are removed. Nonspeculative store instructions are forced to fail, much like STx_C instructions that fail. The NXM block is not cached in the Dcache or Bcache.
WrVictimBlk	Dirty Victims to NXM space are illegal. Systems should perform a machine check, with the 21264/EV68A indicating a severe error.
CleanVictimBlk	The 21264/EV68A can generate CleanVictimBlk commands to NXM space if the Cbox CSR BC_CLEAN_VICTIM[0] bit is asserted and a SysDc ReadDataError has been generated. Systems that use clean victims must faithfully deallocate the CleanVictim VAF entry.
Evict	If the Cbox CSR ENABLE_EVICT is asserted, the 21264/EV68A will generate Evict commands to NXM space. Systems may use this command to invalidate their duplicate tags. Systems must respond with SysDc ChangeToDirtyFail to retire the NXM MAF entry.
RdBytes RdLWs RdQWs	Load instructions to I/O space are not speculative, so an I/O reference to NXM space is an error. Systems must respond with ReadDataError and should generate a machine check to indicate an operating system error.
WrBytes WrLWs WrQWs	Store instructions to I/O space are not speculative, so an I/O reference to NXM space is an error. Systems must respond by deallocating the appropriate IOWB entries, and should generate a machine check to indicate an operating system error.
FetchBlk FetchBlkSpec	Loads to noncached memory in NXM space may be speculative. Systems must respond with a SysDc ReadDataError to retire the MAF entry.

Table 4–32 21264/EV68A Commands with NXM Addresses and System Response (Continued)

21264/EV68A Command NXM Address	System/21264/EV68A Response
CleanToDirty SharedToDirty STCChangeToDirty	ChangeToDirty commands to NXM space are impossible in the 21264/EV68A because all NXM references to memory space are atomically filled with an Invalid cache status.
InvalToDirty InvalToDirtyVic	InvalToDirty commands are not speculative, so InvalToDirty commands to NXM space indicate an operating system error. Systems should respond with a SysDc ReadDataError, and should generate a machine check to indicate error.

4.7.10 Ordering of System Port Transactions

This section describes ordering of system port transactions. The two classes of transactions are listed here:

- 21264/EV68A commands and system probes
- System probes and SysDc transfers

4.7.10.1 21264/EV68A Commands and System Probes

This section describes the interaction of 21264/EV68A-generated commands and system-generated probes that reference the same cache block. Some definitions are presented here:

- ProbeResponses generated by the 21264/EV68A respond to all system-generated probe commands. System-generated data transfer commands respond to all 21264/EV68A-generated data transfer commands.
- The victim address file (VAF) and victim data buffer (VDB) entries each have independent valid bits for both a victim and a probe.
- Probe results indicate a hit on a VAF/VDB and when a WrVictim command has been sent to the system. Systems can decide whether to move the buffer once or twice.
- ProbeResponses are issued in the order that the system-generated probes were received; however, there is no requirement for the system to retain order when issuing release buffer commands.
- Probe processing can stall inside the 21264/EV68A when the probe entry index matches PA[19:6] of a previous probe entry in the VAF.
- The 21264/EV68A reserves one VAF entry for probe processing, so that VAF-full conditions cannot stall the processing of probes at the head of the queue.

Table 4–33 lists all interactions between pending internal 21264/EV68A commands and the Probe[2:0] command field, Next Cache Block State, described in Table 4–22.

Table 4–33 shows the 21264/EV68A response to system probe and in-flight command interaction. In the table, note the following:

- ReadBlkVic and ReadBlkModVic commands do not appear in Table 4–33. If there is interaction between the probe and the victim, it is the same as a WrVictimBlk command.

- Probes that invalidate locked blocks do not generate a ReadBlkMod command. The 21264/EV68A fails the STx_C instruction as defined in the *Alpha Architecture Handbook, Version 4*.
- All read commands (RdBlk, RdBlkMod, Fetch, InvalToDirty) do not interact because the 21264/EV68A does not yet own the block.

Table 4–33 21264/EV68A Response to System Probe and In-Flight Command Interaction

Pending Internal 21264/EV68A Command	21264/EV68A Response to System Probe and In-Flight Command Interaction
ReadBlk ReadBlkMod FetchBlk InvalToDirty WrVictimBlk	This case assumes that a WrVictimBlk command has been sent to the system and another agent has performed a load/store instruction to the same address. The 21264/EV68A provides VAF hit information with the probe response so that the system can manage the race condition between the WrVictimBlk command from this processor and a possible WrVictimBlk command from the probing processor. This race condition can be managed by either forcing the completion of the WrVictimBlk command to memory before allowing the progress by the probing processor, or by killing the WrVictimBlk command in this processor.
CleanToDirty SharedToDirty	This case assumes that a SetDirty command has been sent to the system environment because of a store instruction that hit in the 21264/EV68A caches and that another processor has performed a load/store instruction to the same address. The 21264/EV68A provides MAF hit information so that the system can correctly respond to the Set/Dirty command. If the next state of the probe was Invalid (the other processor performed a store instruction), and the probe reached the system serialization point before the Set/Dirty command, the system must either fail the Set/Dirty command or provide the updated data from the other processor.
STCChangeToDirty	This case is similar to case 2, except that the initiating instruction for the Set/Dirty command is a STx_C. An address match with an invalidating probe must fail the Set/Dirty command. Delivering the updated data from the other processor is not an option because of the requirements of the LDx_L/STx_C instruction pair.

Bcache Port

4.7.10.2 System Probes and SysDc Commands

Ordering of cache transactions at the system serialization point must be reflected in the 21264/EV68A cache system. Table 4–34 shows the rules that a system must follow to control the order of cache status update within the 21264/EV68A cache structures (including the VAF) at the 21264/EV68A pins.

Table 4–34 Rules for System Control of Cache Status Update Order

First	Second	Rule
Probe	Probe	To control the sequence of cache status updates between probes, systems can present the probes in order to the 21264/EV68A, and the 21264/EV68A will update the appropriate cache state (including the VAF) in order.
Probe	SysDc MAF	To ensure that a probe updates the internal cache status before a SysDc MAF transaction (including fills and ChangeToDirtySuccess commands), systems must wait for the probe response before presenting the SysDc MAF command to the 21264/EV68A. To ensure that a probe updates a VAF entry before a SysDc VAF (release buffer), systems must wait for the probe response.
Probe	SysDc VAF	Same as Probe/SysDc MAF, above.
SysDc MAF	Probe	To ensure that a SysDc MAF command updates the 21264/EV68A cache system before a probe to the same address, systems must deliver the D1 (the second QW of data delivered to the 21264/EV68A) before or in the same cycle as the A3 of the probe (the last cycle of the 4-cycle probe command). This rule also applies to ChangeToDirtySuccess commands that have a virtual D0 and D1 transaction.
SysDc MAF	SysDc MAF	SysDc MAF transactions can be ordered into the 21264/EV68A by ordering them appropriately at the 21264/EV68A interface.
SysDc MAF	SysDc VAF	SysDc MAF transactions and SysDc VAF transactions cannot interact within the 21264/EV68A because the 21264/EV68A does not generate MAF transactions to the same address as existing VAF transactions.
SysDc VAF	Probe	To ensure that a SysDc VAF invalidates a VAF entry before a probe to the same address, the SysDc VAF command must precede the first cycle of the 4-cycle probe command.
SysDc VAF	SysDc MAF	SysDc MAF transactions and SysDc VAF transactions cannot interact within the 21264/EV68A because the 21264/EV68A does not generate MAF transactions to the same address as existing VAF transactions.
SysDc VAF	SysDc VAF	SysDc VAF transactions can be ordered into the 21264/EV68A by ordering them appropriately at the 21264/EV68A interface.

4.8 Bcache Port

The 21264/EV68A supports a second-level cache (Bcache) with 64-byte blocks. The Bcache size can be 1MB, 2MB, 4MB, 8MB, or 16MB. The Bcache port has a 144-bit data bus that is used for data transfers between the 21264/EV68A and the Bcache. All Bcache control and address signal lines are clocked synchronously on Bcache clock cycle boundaries.

The Bcache supports the following multiples of the GCLK period: 1.5X (dual-data mode only), 2X, 2.5X, 3X, 3.5X, 4X, 5X, 6X, 7X, and 8X. However, the 21264/EV68A imposes a maximum Bcache clock period based on the SYSCLK ratio. Table 4–35 lists the range of maximum Bcache clock periods. Section 4.7.8.2 describes fast mode.

Table 4–35 Range of Maximum Bcache Clock Ratios

SYSCLK Ratio	Bcache Clock Ratio with Fast Mode Enabled	Bcache Clock Ratio with Fast Mode Disabled
1.5X	4.0X	7.0X
2.0X	4.0X	7.0X
2.5X	5.0X	8.0X
3.0X	6.0X	8.0X
3.5X	7.0X	8.0X
4.0X	7.0X	8.0X
5.0X	8.0X	8.0X
6.0X	8.0X	8.0X
7.0X	8.0X	8.0X
8.0X	8.0X	8.0X

The 21264/EV68A provides a range of programmable Cbox CSRs to manipulate the Bcache port pins so that a variety of industry-standard SSRAMs can communicate efficiently with the 21264/EV68A. The following SSRAMs can be used:

- Nonburst mode Reg/Reg late-write SSRAMs
- Burst mode Reg/Reg late-write dual-data SSRAMs

4.8.1 Bcache Port Pins

Table 3–1 defines the 21264/EV68A signal types referred to in this section. Table 4–36 lists the Bcache port pin groups along with their type, number, reference clock, and functional description.

Table 4–36 Bcache Port Pins

Pin Name	Type	Count	Reference Clock	Description
BcAdd_H[23:4]	O_PP	20	Int_Index_BcClk	Bcache index
BcCheck_H[15:0]	B_DA_PP	16	Int_Data_BcClk ⇒ output BcDataInClk_H ⇒ input	ECC check bits for BcData
BcData_H[127:0]	B_DA_PP	128	Int_Data_BcClk ⇒ output BcDataInClk_H ⇒ input	Bcache data
BcDataInClk_H[7:0]	I_DA	8	NA	Bcache data input clocks
BcDataOE_L	O_PP	1	Int_Index_BcClk	Bcache data output enable/chip select
BcDataOutClk_H[3:0] BcDataOutClk_L[3:0]	O_PP	8	NA	Bcache data clocks— high and low version

Bcache Port

Table 4–36 Bcache Port Pins (Continued)

Pin Name	Type	Count	Reference Clock	Description
BcDataWr_L	O_PP	1	Int_Index_BcClk	Bcache data write enable
BcLoad_L	O_PP	1	Int_Index_BcClk	Bcache burst enable
BcTag_H[42:20]	B_DA_PP	23	Int_Data_BcClk ⇒ output BcTagInClk_H ⇒ input	Bcache tag data
BcTagDirty_H	B_DA_PP	1	Int_Data_BcClk ⇒ output BcTagInClk_H ⇒ input	Bcache tag dirty bit
BcTagInClk_H	I_DA	1	NA	Tag input data reference clock
BcTagOE_L	O_PP	1	Int_Index_BcClk	Bcache tag output enable/chip select
BcTagOutClk_H BcTagOutClk_L	O_PP	2	NA	Bcache tag clock— high and low versions
BcTagParity_H	B_DA_PP	1	Int_Data_BcClk ⇒ output BcTagInClk_H ⇒ input	Bcache tag parity bit
BcTagShared_H	B_DA_PP	1	Int_Data_BcClk ⇒ output BcTagInClk_H ⇒ input	Bcache tag shared bit
BcTagValid_H	B_DA_PP	1	Int_Data_BcClk ⇒ output BcTagInClk_H ⇒ input	Bcache tag valid bit
BcVref	I_DC_REF	1	NA	Input reference voltage for tag data
BcTagWr_L	O_PP	1	Int_Index_BcClk	Bcache data write enable

4.8.2 Bcache Clocking

For clocking, the Bcache port pins can be divided into three groups.

1. The Bcache index pins (address and control) are referenced to Int_Add_BcClk, an internal version of the Bcache forwarded clock. The index pins are valid for the whole period of the Int_Add_BcClk. The index pins are:

BcAdd_H[23:4]
BcDataOE_L
BcDataWr_L
BcLoad_L
BcTagOE_L
BcTagWr_L

2. The data pins, when driven as outputs, are referenced to Int_Data_BcClk, another internal version of the Bcache forwarded clock. The data pins, when used as inputs, can be referenced to the incoming Bcache clocks, **BcDataInClk_H[7:0]** and **BcTagInClk_H**. Int_Data_BcClk can be delayed relative to Int_Add_BcClk from 0 to 3 GCLK cycles by using Cbox CSR BC_CPU_CLK_DELAY[1:0]. The data pins are:

BcCheck_H[15:0]
BcData_H[127:0]
BcTag_H[42:20]
BcTagDirty_H
BcTagParity_H

BcTagShared_H
BcTagValid_H

- The Bcache clock pins (**BcDataOutClk_x[3:0]** and **BcTagOutClk_x**) clock the index and data pins at the SSRAMs. These clocks can be delayed from **Int_Data_BcClk** from 0 to 2 GCLK phases (half cycles) using Cbox CSR **BC_CPU_CLK_DELAY[1:0]**.

Table 4–37 provides the **BC_CPU_CLK_DELAY[1:0]** values, which is the delay from **BC_ADDRESS** to **BC_WRITE_DATA** (and **BC_CLOCK_OUT**) in GCLK cycles.

Table 4–37 BC_CPU_CLK_DELAY[1:0] Values

BC_CPU_CLK_DELAY[1:0] Value	GCLK Cycles of Delay
0	0
1	1
2	2
3	3

In the 21264/EV68A topology, the index pins are loaded by all the SSRAMs, while the clock and data pins see a limit load. This arrangement requires a relatively large amount of delay between the index pins and the Bcache clock pins to meet the setup constraints at the SSRAMs. The 21264/EV68A Cbox CSRs can provide a programmable amount of delay between the index and clock pins by using Cbox CSRs **BC_CPU_CLK_DELAY[1:0]** and **BC_CLK_DELAY[1:0]**.

Table 4–38 provides the **BC_CLK_DELAY[1:0]** values, which is the delay from **BC_WRITE_DATA** to **BC_CLOCK_OUT**, in GCLK phases.

Table 4–38 BC_CLK_DELAY[1:0] Values

BC_CLK_DELAY[1:0] Value	GCLK Phases
0	Invalid (turns off BC_CLOCK_OUT)
1	0
2	1
3	2

With **BC_CPU_CLK_DELAY[1:0]** and **BC_CLK_DELAY[1:0]**, a 500-MHz 21264/EV68A can provide up to 8 ns ($3 \times 2 + 2$) of delay between the index and the outgoing forwarded clocks. The relative loading difference between the data and the clock is minimal, so Cbox CSR **BC_CLK_DELAY[1:0]** alone is sufficient to provide the delay needed for the setup constraint at the Bcache data register.

4.8.2.1 Setting the Period of the Cache Clock

The free running Bcache clocks are derived from the 21264/EV68A GCLK. The period of the Bcache clocks is programmed using the following three Cbox CSRs:

- BC_CLK_LD_VECTOR[15:0]**
- BC_BPHASE_LD_VECTOR[3:0]**

Bcache Port

3. BC_FDBK_EN[7:0]

To program these three CSRs, the programmer must know the bit-rate of the Bcache data, and whether only the rising edge or both edges of the clock are used to latch data. For example, a 200-MHz late-write SSRAM has a data period of 5 ns. For a 2-ns GCLK, the READCLK_RATIO must be set to 2.5X. This part is called a 2.5X SD (single-data part).

Table 4–39 shows how the three CSRs are programmed for single-data devices.

Table 4–39 Program Values to Set the Cache Clock Period (Single-Data)

Bcache Transfer	BC_CLK_LD_VECTOR ¹	BC_BPHASE_LD_VECTOR ¹	BC_FDBK_EN ¹
2.0X-SD	5555	0	01
2.5X-SD	94A5	3	02
3.0X-SD	9249	A	02
3.5X-SD	4C99	C	04
4.0X-SD	3333	0	01
5.0X-SD	8C63	5	02
6.0X-SD	71C7	0	10
7.0X-SD	C387	A	04
8.0X-SD	0F0F	0	01

¹ These are hexadecimal values.

With the exception of the 2.5X-SD and 3.5X-SD cases, the clock waveform generated by the 21264/EV68A for the forwarded clocks has a 50-50 duty cycle. In the 2.5X-SD case, the 21264/EV68A produces an asymmetric clock that is high for two GCLK phases and low for three phases. Likewise, for the 3.5X-SD case, the 21264/EV68A produces an asymmetric clock that is high for three GCLK phases and low for four GCLK phases. Also, for both of these cases, the 21264/EV68A will only start transactions on the rising edge of the GCLK and the Bcache clock. The 1.5X-SD case is not supported.

A dual-data rate (DDR) SSRAM's data rate is derived in a similar manner, except that because both edges of the clock are used, the SSRAM clock generated is 2X the period of the data. This part is called a 2.5X DDR SSRAM.

Table 4–40 shows how the three CSRs are programmed for dual-data devices.

Table 4–40 Program Values to Set the Cache Clock Period (Dual-Data Rate)

Bcache Transfer	BC_CLK_LD_VECTOR ¹	BC_BPHASE_LD_VECTOR ¹	BC_FDBK_EN ¹
1.5X-DD	9249	A	02
2.0X-DD	3333	0	01
2.5X-DD	8C63	5	02
3.0X-DD	71C7	0	10

Table 4–40 Program Values to Set the Cache Clock Period (Dual-Data Rate) (Continued)

Bcache Transfer	BC_CLK_LD_VECTOR ¹	BC_BPHASE_LD_VECTOR ¹	BC_FDBK_EN ¹
3.5X-DD	C387	A	04
4.0X-DD	0F0F	0	01
5.0X-DD	7C1F	0	40
6.0X-DD	F03F	0	10
7.0X-DD	C07F	0	04
8.0X-DD	00FF	0	01

¹ These are hexadecimal values.

In addition to programming the clock CSRs, the data-sample/drive Cbox CSRs, at the pads, must be set appropriately. Table 4–41 lists these CSRs and provides their programmed value.

Table 4–41 Data-Sample/Drive Cbox CSRs

CBOX CSR	Description
BC_DDM_FALL_EN[0]	Enables the update of the 21264/EV68A's Bcache outputs referenced to the falling edge of the Bcache forwarded clock. Dual-data RAMs assert this CSR.
BC_TAG_DDM_FALL_EN[0]	Enables the update of the 21264/EV68A's Bcache tag outputs referenced to the falling edge of the Bcache forwarded clock. Always deasserted.
BC_DDM_RISE_EN[0]	Enables the update of the 21264/EV68A's Bcache outputs referenced to the rising edge of the Bcache forwarded clock. Always asserted.
BC_TAG_DDM_RISE_EN[0]	Enables the update of the 21264/EV68A's Bcache tag outputs referenced to the rising edge of the Bcache forwarded clock. Always asserted.
BC_DDMF_ENABLE[0]	Enables the rising edge of the Bcache forwarded clock. Always asserted.
BC_DDMR_ENABLE[0]	Enables the falling edge of the Bcache forwarded clock. Always asserted.
BC_FRM_CLK[0]	Forces the 21264/EV68A to only start Bcache transactions on the rising edge of Bcache clocks that also coincide with the rising edge of GCLK. Must be asserted for all dual-data parts and single-data parts at 2.5X and 3.5X.
BC_CLKFWD_ENABLE[0]	Enables clock forward enable. Always asserted.

4.8.3 Bcache Transactions

The Cbox uses the programmed clock values to start data read, tag read, data write, and tag write transactions on the rising edge of a Bcache clock. The Cbox can also be configured to introduce a programmable number of bubbles when changing between write and read commands. The following three sections describe these Bcache transactions.

4.8.3.1 Bcache Data Read and Tag Read Transactions

The 21264/EV68A always reads four pieces of data (64 bytes) from the Bcache during a data read transaction, and always interrogates the tag array on the first cycle. Once started, data read transactions are never cancelled. Assuming that the appropriate values

have been programmed for the Bcache clock period, and with satisfactory delay parameters for the SSRAM setup/hold Bcache address latch requirements, a Bcache read command proceeds through the 21264/EV68A Cbox as follows:

1. When the 21264/EV68A clocks out the first address value on the Bcache index pins with the appropriate `Int_Add_BcClk` value, the Cbox loads the values of Cbox CSR `BC_LAT_DATA_PATTERN[31:0]` and Cbox CSR `BC_LAT_TAG_PATTERN[23:0]` into two shift registers, which shift during every GCLK cycle.
2. The address and control pins are latched into the SSRAMs. During the next cycle, the SSRAMs provide data and tag information to the 21264/EV68A.
3. Using the returning forwarded clocks (`BcDataInClk_H[7:0]`, `BcTagInClk_H`), the data/tag information is loaded into the 21264/EV68A clock forwarding queue for the Bcache.
4. Based on the value of `BC_RCV_MUX_PRESET_CNT[1,0]` (the unload pointer), the result of a Bcache write command is loaded into a 21264/EV68A GCLK (BPHASE) register.
5. The Cbox CSR `BC_LAT_DATA_PATTERN[31:0]` and `BC_LAT_TAG_PATTERN[23:0]` contain the GCLK frequency at which the output of the clock forward FIFO can be consumed by the processor. This provides GCLK granularity for the Bcache interface, so that the 21264/EV68A can minimize latency to the Bcache. When the values based on these Cbox CSRs are shifted down to the bottom of the shift register, the processor samples the Bcache data and delivers it to the consumers of load data in the 21264/EV68A functional units.

For example, when a 2.5X-SD SSRAM has a latency of eight GCLK cycles from `BcAdd_H[23:4]` to the output of Bcache FIFO, Cbox CSR `BC_LAT_DATA_PATTERN[31:0]` is programmed to 948_{16} and Cbox CSR `BC_LAT_TAG_PATTERN[23:0]` is programmed to 8_{16} . The data pattern contains the placement for four pieces of data and the aggregate rate of the data is 2.5X. In addition, bit one of the `BC_LAT_DATA_PATTERN` is placed at a GCLK latency of six GCLK cycles, which is the minimum latency supported by the 21264/EV68A. The `BC_LAT_TAG_PATTERN` contains the placement of the tag data to the 21264/EV68A.

A shift of one to the left increases the latency of the Bcache transfer to nine GCLK cycles, and a shift to the right reduces the latency of the Bcache transfer to seven GCLK cycles.

The Cbox performs isolated tag read transactions in response to system probe commands. In addition, when using burst-mode SSRAMs, the Cbox can combine a separate tag read transaction with the tail end of a data read transaction, thus optimizing Bcache bandwidth. A Bcache tag read transaction proceeds exactly like a Bcache data read transaction, except that only the `BC_LAT_TAG_PATTERN` is used to update the tag shift register.

4.8.3.2 Bcache Data Write Transactions

During a data write transaction, the 21264/EV68A always writes four pieces of data (64 bytes of data and 8 bytes of ECC) to the Bcache, and always writes the tag array during the first cycle. Once started, data write operations are never cancelled. Given the appro-

appropriate programming of the Bcache clock period and delay parameters to satisfy SSRAM setup/hold requirements of the Bcache address latch, a Bcache write transaction proceeds through the Cbox as follows:

1. The Cbox transmits the index and write control signals during an Int_Adr_BcClk edge.
2. The data is placed on Bcache data, tag, and tag status pins on the appropriate Int_Data_BcClk edge from 0 to 7 Bcache bit-times later, based on the Cbox CSR BC_LATE_WRITE_NUM[2:0]. The BC_LATE_WRITE_NUM[2:0] supports the late-write SSRAM, which optimize Bcache data bus bandwidth by minimizing bubbles between read and write transactions. For example, single-data late-write SSRAMs would need this CSR programmed to a value of one, and dual-data late-write SSRAMs would need this CSR programmed to a value of two.
3. The difference between the data delivery (Int_Data_BcClk) and forwarded clocks out provides the setup for the data at the Bcache data flip-flop.
4. For Bcache writes, the 21264/EV68A drivers are enabled on the GCLK BPHASE preceding the start of a write transfer, and disabled on the succeeding GCLK BPHASE at the end of a write transfer. Thus, the write data is enveloped by the 21264/EV68A drivers to guarantee that every data transfer has the same data-valid window.

4.8.3.3 Bubbles on the Bcache Data Bus

When changing between read and write transactions on the bidirectional bus, it is often necessary to introduce NOP cycles (bubbles) to allow the bus to settle and to drain the Bcache read pipeline. The Cbox provides two CSRs, BC_RD_WR_BUBBLES[5:0] and BC_WR_RD_BUBBLES[3:0], to help control the bubbles between read and write transactions.

The optimum parameters for these CSRs are determined by formulas that include the following terms:

Term	Description						
bcfrm	<p>Bcache frame clock.</p> <ul style="list-style-type: none"> • In dual-data mode, bcfrm is twice the ratio. • In single-data mode, the value for bcfrm is determined by whether the ratio is even or odd: <ul style="list-style-type: none"> – When the ratio is even, bcfrm is equal to the ratio. – When the ratio is odd, bcfrm is twice the ratio. <p>For example, in single-data mode:</p> <table style="margin-left: 40px;"> <thead> <tr> <th>Ratio</th> <th>Bcfrm</th> </tr> </thead> <tbody> <tr> <td>2</td> <td>2</td> </tr> <tr> <td>2.5</td> <td>5</td> </tr> </tbody> </table>	Ratio	Bcfrm	2	2	2.5	5
Ratio	Bcfrm						
2	2						
2.5	5						
GCLK	The processor clock.						

Term	Description
Ratio	The number of GCLK cycles per peak Bcache bandwidth transfer. For example, a ratio of 2.5 means the peak Bcache bandwidth is 16 bytes for every 2.5 GCLK cycles.
rd_wr	The minimum spacing required between the read and write indices at the data/tag pins, expressed as GCLK cycles.
wr_rd	The minimum spacing required between the write and read indices at the data/tag pins, expressed as GCLK cycles.

The Relationship Between Write-to-Read — BC_WR_RD_BUBBLES and wr_rd

The following formulas calculate the relationship between the Cbox CSR BC_WR_RD_BUBBLES and wr_rd:

$$\text{wr_rd} = (\text{BC_WR_RD_BUBBLES} - 1) * \text{bcfrm}$$

or

$$\text{BC_WR_RD_BUBBLES} = ((\text{wr_rd} + \text{bcfrm} - 1) / \text{bcfrm}) + 1$$

There is never a need to use a value of 0 or 1 for BC_WR_RD_BUBBLES.

If $\text{wr_rd} = 4 * \text{ratio}$, then value 3 would be the minimum BC_WR_RD_BUBBLES value when $\text{bcfrm} = 2 * \text{ratio}$, and value 5 would be the minimum BC_WR_RD_BUBBLES value when $\text{bcfrm} = \text{ratio}$.

There is a special case for $\text{ratio} = 2.0$ in single-data mode. In this case, the formula is:

$$\text{wr_rd} = (\text{BC_WR_RD_BUBBLES} - 2) * \text{bcfrm}$$

The Relationship Between Read-to-Write — BC_RD_WR_BUBBLES and rd_wr

Use the following formula to calculate the value for the Cbox CSR BC_RD_WR_BUBBLES that produces the minimum rd_wr restriction:

$$\text{BC_RD_WR_BUBBLES} = \text{rd_wr} - 6$$

Note that a value for BC_RD_WR_BUBBLES of zero really means 64 GCLK cycles. In that case, amend the formula. For example, it is impossible to have $\text{rd_wr} = 6$ in the 1.5x dual-data rate mode case.

4.8.4 Pin Descriptions

This section describes the characteristics of the Bcache interface pins.

4.8.4.1 BcAdd_H[23:4]

The **BcAdd_H[23:4]** pins are high drive outputs that provides the index for the Bcache. The 21264/EV68A supports Bcache sizes of 1MB, 2MB, 4MB, 8MB, and 16MB. Table 4–42 lists the values to be programmed into Cbox CSRs **BC_ENABLE[0]** and **BC_SIZE[3:0]** to support each size of the Bcache.

Table 4–42 Programming the Bcache to Support Each Size of the Bcache

BC_ENABLE[0]	BC_SIZE[3:0]	Bcache Size
1	0000	1MB
1	0001	2MB
1	0011	4MB
1	0111	8MB
1	1111	16MB

When the Cbox CSR **BC_BANK_ENABLE[0]** is not set, the unused **BcAdd_H[23:4]** pins are tied to zero. For example, when configured as a 4MB cache, the 21264/EV68A never changes **BcAdd_H[23:22]** from logic zero, and when **BC_BANK_ENABLE[0]** is asserted, the 21264/EV68A drives the complement of the MSB index on the next higher **BcAdd_H** pin.

4.8.4.2 Bcache Control Pins

The Bcache control pins (**BcLoad_L**, **BcDataWr_L**, **BcDataOE_L**, **BcTagWr_L**, **BcTagOE_L**) are controlled using Cbox CSRs **BC_BURST_MODE_ENABLE[0]** and **BC_PENTIUM_MODE[0]**.

Table 4–43 shows the four combinations of Bcache control pin behavior obtained using the two CSRs.

Table 4–43 Programming the Bcache Control Pins

BC_PENTIUM_MODE	BC_BURST_MODE_ENABLE	RAM_TYPE
0	0	RAM_TYPE A
0	1	RAM_TYPE B
1	0	Unsupported
1	1	Unsupported

Table 4–44 lists the combination of control pin assertion for **RAM_TYPE A**.

Table 4–44 Control Pin Assertion for RAM_TYPE A

TYPE_A	NOP	RA0	RA1	RA2	RA3	NOP	NOP	WA0	WA1	WA2	WA3	NOP
BcLoad_L	H	H	H	H	H	H	H	H	H	H	H	H
BcDataOE_L	H	L	L	L	L	H	H	L	L	L	L	H
BcDataWr_L	H	H	H	H	H	H	H	L	L	L	L	H
BcTagOE_L	H	L	H	H	H	H	H	L	H	H	H	H
BcTagWr_L	H	H	H	H	H	H	H	L	H	H	H	H

Bcache Port

Table 4–45 lists the combination of control pin assertion for RAM_TYPE B.

Table 4–45 Control Pin Assertion for RAM_TYPE B

TYPE_B	NOP	RA0	RA1	RA2	RA3	NOP	NOP	WA0	WA1	WA2	WA3	NOP
BcLoad_L	H	L	H	H	H	H	H	L	H	H	H	H
BcDataOE_L	H	L	L	L	L	H	H	L	L	L	L	H
BcDataWr_L	L	H	H	H	H	L	L	L	L	L	L	L
BcTagOE_L	H	L	H	H	H	H	H	L	H	H	H	H
BcTagWr_L	H	H	H	H	H	H	H	L	H	H	H	H

Table 4–46 lists the combination of control pin assertion for RAM_TYPE C.

Table 4–46 Control Pin Assertion for RAM_TYPE C

TYPE_C	NOP	RA0	RA1	RA2	RA3	NOP	NOP	WA0	WA1	WA2	WA3	NOP
BcLoad_L	H	H	H	H	H	H	H	H	H	H	H	H
BcDataOE_L	H	H	L	L	L	L	L	H	H	H	H	H
BcDataWr_L	H	H	H	H	H	H	H	L	L	L	L	H
BcTagOE_L	H	L	L	H	H	H	H	H	H	H	H	H
BcTagWr_L	H	H	H	H	H	H	H	L	H	H	H	H

Table 4–47 lists the combination of control pin assertion for RAM_TYPE D.

Table 4–47 Control Pin Assertion for RAM_TYPE D

TYPE_D	NOP	RA0	RA1	RA2	RA3	NOP	NOP	WA0	WA1	WA2	WA3	NOP
BcLoad_L	H	L	H	H	H	H	H	L	H	H	H	H
BcDataOE_L	H	H	L	L	L	L	L	H	H	H	H	H
BcDataWr_L	H	H	H	H	H	H	H	L	L	L	L	H
BcTagOE_L	H	H	L	L	H	H	H	H	H	H	H	H
BcTagWr_L	H	H	H	H	H	H	H	L	H	H	H	H

Notes:

1. The NOP condition for RAM_TYPE B is consistent with bursting nonPentium style SSRAMs.
2. In both RAM_TYPE A and RAM_TYPE B, the pins **BcDataOE_L** and **BcTagOE_L** function changes from output-enable control to chip-select control.
3. In both RAM_TYPE C and RAM_TYPE D SSRAMs, the pins **BcDataOE_L** and **BcTagOE_L** function as an asynchronous output enable that envelopes the Bcache read data by providing an extra cycle of output enable.

Using these Cbox CSRs, late-write nonbursting and dual-data rate SSRAMs can be connected to the 21264/EV68A as described in Appendix E.

4.8.4.3 BcDataInClk_H and BcTagInClk_H

The **BcDataInClk_H[7:0]** and **BcTagInClk_H** pins are used to capture tag data and data from the Bcache data and tag RAMs respectively. Dual-data rate SSRAMs provide a clock output with the data output pins to minimize skew between the data and clock, thus allowing maximum bandwidth. The 21264/EV68A internally synchronizes the data to its GCLK with clock forward receive circuitry similar to that in the system interface. For nonDDR SSRAMs, systems can connect the Bcache data and tag output clock pins to the Bcache data and tag input clock pins.

4.8.5 Bcache Banking

Bcache banking is possible by decoding the index MSB (as determined by Cbox CSR BC_SIZE[3:0]) and asserting Cbox CSR BC_BANK_ENABLE[0]. To facilitate banking, the 21264/EV68A provides the complement of the MSB bit in the next higher unused index bit. For example, when configured as an 8MB cache with banking enabled, the 21264/EV68A drives the inversion of PA[22] on **BcAdd_H[23]** for use as a chip enable in a banked configuration. Because there is no higher index bit available for 16MB caches, this scheme only works for cache sizes of 1MB, 2MB, 4MB, and 8MB.

Setting BC_RD_RD_BUBBLE to 1 introduces one Bcache clock cycle of delay between consecutive read transactions, regardless of whether or not they are read transactions to the same bank.

Setting BC_WR_WR_BUBBLE to 1 introduces one Bcache clock cycle of delay between consecutive write transactions, regardless of whether or not they are write transactions to the same bank.

Setting BC_SJ_BANK_ENABLE to 1 introduces one Bcache clock cycle of delay between consecutive read transactions to a different bank (based on the MSB of the index), even if BC_RD_RD_BUBBLE is set to 0. No additional delay is inserted between consecutive read transactions to the same bank or between consecutive write transactions.

4.8.6 Disabling the Bcache for Debugging

The Bcache is a required component for a 21264/EV68A-based system. However, for debug purposes, the 21264/EV68A can be operated with the Bcache disabled. The Bcache can be disabled by clearing all of the BC_ENABLE bits in the Cbox WRITE_MANY CSR. When disabling the Bcache, the following additional steps must be taken:

1. The various Bcache control bits in the Cbox WRITE_ONCE chain must be programmed to a valid combination (normally the same settings that would be used if the Bcache were enabled).
2. The Bcache must still be initialized (using BC_INIT mode) during the reset PAL flow, after which the Bcache should be left disabled.
3. Error Detection and Correction should be disabled by clearing DC_DAT_ERR_EN (bit 7 of the DC_CTL IPR), or the following bits in the Cbox WRITE_ONCE chain must be programmed to the indicated values:

```
BC_CLK_DELAY[1:0]      = 0x1
BC_CPU_CLK_DELAY[1:0] = 0x1
```

Interrupts

```
BC_CPU_LATE_WRITE_NUM[1:0] = 0x1
BC_LATE_WRITE_NUM[2:0]     = 0x0
BC_LATE_WRITE_UPPER        = 0
DUP_TAG_ENABLE             = 0
```

4.9 Interrupts

The system may request interrupts by way of the **IRQ_H[5:0]** pins. These six interrupt sources are identical. They may be asynchronous, are level sensitive, and can be individually masked by way of the EIE field of the CM_IER IPR. The system designer determines how these signals are used and selects their relative priority.

Internal Processor Registers

This chapter describes 21264/EV68A internal processor registers (IPRs). They are separated into the following circuit logic groups: Ebox, Ibox, Mbox, and Cbox.

The gray areas in register figures indicate reserved fields. Bit ranges that are coupled with the field name specify those bits in that named field that are included in the IPR. For example, in Figure 5–2, the field named COUNTER[31:4] contains bits 31 through 4 of the COUNTER field from Section 5.1.1. The bit range of COUNTER[31:4] in the IPR is also listed in the column *Extent* in Table 5–2. In many cases, such as this one, the bit ranges correspond. However, the bit range of the named field need not always correspond to the *Extent* in the IPR. For example, in Figure 5–14, the field VA[47:13] resides in IPR IVA_FORM[37:3] under the stated conditions.

The register contents after initialization are listed in Section 7.8.

Table 5–1 lists the 21264/EV68A internal processor registers.

Table 5–1 Internal Processor Registers

Register Name	Mnemonic	Index (Binary)	Score- Board Bit	Access	MT/MF Issued from Ebox Pipe	Latency for MFPR (Cycles)
Ebox IPRs						
Cycle counter	CC	1100 0000	5	RW	1L	1
Cycle counter control	CC_CTL	1100 0001	5	W0	1L	—
Virtual address	VA	1100 0010	4, 5, 6, 7	RO	1L	1
Virtual address control	VA_CTL	1100 0100	5	W0	1L	—
Virtual address format	VA_FORM	1100 0011	4, 5, 6, 7	RO	1L	1
Ibox IPRs						
ITB tag array write	ITB_TAG	0000 0000	6	W0	0L	—
ITB PTE array write	ITB_PTE	0000 0001	4, 0	W0	0L	—
ITB invalidate all process (ASM=0)	ITB_IAP	0000 0010	4	W0	0L	—
ITB invalidate all	ITB_IA	0000 0011	4	W0	0L	—
ITB invalidate single	ITB_IS	0000 0100	4, 6	W0	0L	—
ProfileMePC	PMPC	0000 0101	—	RO	—	—
Exception address	EXC_ADDR	0000 0110	—	RO	0L	3

Table 5–1 Internal Processor Registers (Continued)

Register Name	Mnemonic	Index (Binary)	Score-Board Bit	Access	MT/MF Issued from Ebox Pipe	Latency for MFPR (Cycles)
Instruction VA format	IVA_FORM	0000 0111	5	RO	0L	3
Current mode	CM	0000 1001	4	RW	0L	3
Interrupt enable	IER	0000 1010	4	RW	0L	3
Interrupt enable and current mode	IER_CM	0000 10xx	4	RW	0L	3
Software interrupt request	SIRR	0000 1100	4	RW	0L	3
Interrupt summary	ISUM	0000 1101	—	RO	—	—
Hardware interrupt clear	HW_INT_CLR	0000 1110	4	WO	0L	—
Exception summary	EXC_SUM	0000 1111	—	RO	0L	3
PAL base address	PAL_BASE	0001 0000	4	RW	0L	3
Ibox control	I_CTL	0001 0001	4	RW	0L	3
Ibox status	I_STAT	0001 0110	4	RW	0L	3
Icache flush	IC_FLUSH	0001 0011	4	W	0L	—
Icache flush ASM	IC_FLUSH_ASM	0001 0010	4	WO	0L	—
Clear virtual-to-physical map	CLR_MAP	0001 0101	4, 5, 6, 7	WO	0L	—
Sleep mode	SLEEP	0001 0111	4, 5, 6, 7	WO	0L	—
Process context register	PCTX	01xn nmm ¹	4	W	0L	3
Process context register	PCTX	01xx xxxx	4	R	0L	3
Performance counter control	PCTR_CTL	0001 0100	4	RW	0L	3
Mbox IPRs						
DTB tag array write 0	DTB_TAG0	0010 0000	2, 6	WO	0L	—
DTB tag array write 1	DTB_TAG1	1010 0000	1, 5	WO	1L	—
DTB PTE array write 0	DTB_PTE0	0010 0001	0, 4	WO	0L	—
DTB PTE array write 1	DTB_PTE1	1010 0001	3, 7	WO	0L	—
DTB alternate processor mode	DTB_ALTMODE	0010 0110	6	WO	1L	—
DTB invalidate all process (ASM = 0)	DTB_IAP	1010 0010	7	WO	1L	—
DTB invalidate all	DTB_IA	1010 0011	7	WO	1L	—
DTB invalidate single (array 0)	DTB_IS0	0010 0100	6	WO	0L	—
DTB invalidate single (array 1)	DTB_IS1	1010 0100	7	WO	1L	—
DTB address space number 0	DTB_ASN0	0010 0101	4	WO	0L	—
DTB address space number 1	DTB_ASN1	1010 0101	7	WO	1L	—
Memory management status	MM_STAT	0010 0111	—	RO	0L	3
Mbox control	M_CTL	0010 1000	6	WO	0L	—
Dcache control	DC_CTL	0010 1001	6	WO	0L	—
Dcache status	DC_STAT	0010 1010	6	RW	0L	3

Table 5–1 Internal Processor Registers (Continued)

Register Name	Mnemonic	Index (Binary)	Score-Board Bit	Access	MT/MF Issued from Ebox Pipe	Latency for MFPR (Cycles)
Cbox IPRs						
Cbox data	C_DATA	0010 1011	6	RW	0L	3
Cbox shift control	C_SHFT	0010 1100	6	WO	0L	0

¹When n equals 1, that process context field is selected (FPE, PPCE, ASTRR, ASTER, ASN).

5.1 Ebox IPRs

This section describes the internal processor registers that control Ebox functions.

5.1.1 Cycle Counter Register – CC

The cycle counter register (CC) is a read-write register. The lower half of CC is a counter that, when enabled by way of CC_CTL[32], increments once each CPU cycle. The upper half of the register is 32 bits of register storage that may be used as a counter offset as described in the *Alpha Architecture Handbook, Version 4* under Processor Cycle Counter (PCC) Register.

A HW_MTPR instruction to the CC writes the upper half of the register and leaves the lower half unchanged. The RPCC instruction returns the full 64-bit value of the register. Figure 5–1 shows the cycle counter register.

Figure 5–1 Cycle Counter Register

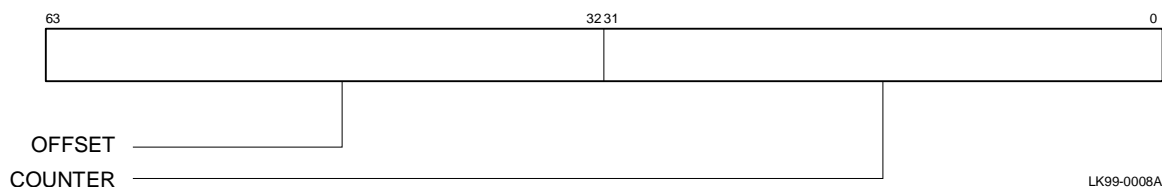

5.1.2 Cycle Counter Control Register – CC_CTL

The cycle counter control register (CC_CTL) is a write-only register through which the lower half of the CC register may be written and its associated counter enabled and disabled. Figure 5–2 shows the cycle counter control register.

Figure 5–2 Cycle Counter Control Register

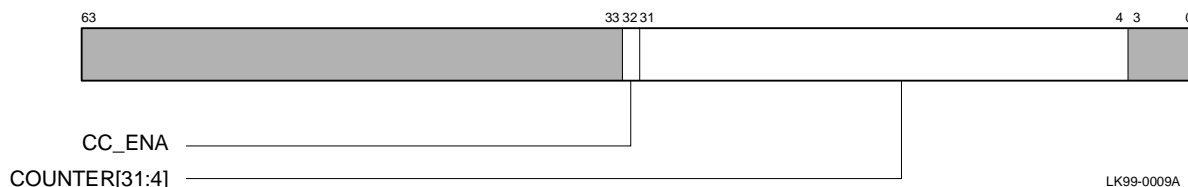

Table 5–2 describes the CC_CTL register fields.

Table 5–2 Cycle Counter Control Register Fields Description

Name	Extent	Type	Description
Reserved	[63:33]	—	—
CC_ENA	[32]	WO	Counter Enable. When set, this bit allows the cycle counter to increment.
COUNTER[31:4]	[31:4]	WO	CC[31:4] may be written by way of this field. Write transactions to CC_CTL result in CC[3:0] being cleared.
Reserved	[3:0]	—	—

5.1.3 Virtual Address Register – VA

The virtual address register (VA) is a read-only register. When a DTB miss or fault occurs, the associated effective virtual address is written into the VA register. VA is not written when a LD_VPTE gets a DTB miss or Dstream fault. Figure 5–3 shows the virtual address register.

Figure 5–3 Virtual Address Register

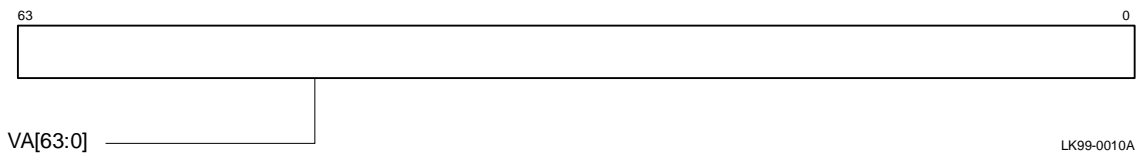

5.1.4 Virtual Address Control Register – VA_CTL

The virtual address control register (VA_CTL) is a write-only register that controls the way in which the faulting virtual address stored in the VA register is formatted when it is read by way of the VA_FORM register. It also contains control bits that affect the behavior of the memory pipe virtual address sign extension checkers and the behavior of the Ebox extract, insert, and mask instructions. Figure 5–4 shows the virtual address control register.

Figure 5–4 Virtual Address Control Register

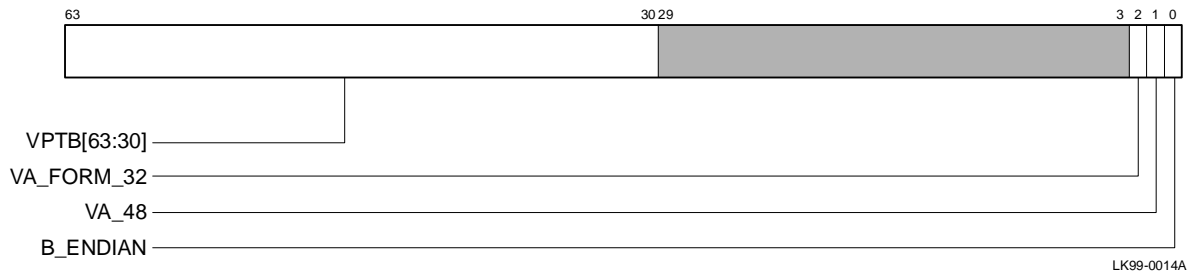

Table 5–3 describes the virtual address control register fields.

Table 5–3 Virtual Address Control Register Fields Description

Name	Extent	Type	Description
VPTB[63:30]	[63:30]	WO	Virtual Page Table Base. See the VA_FORM register section for details.
Reserved	[29:3]	—	—
VA_FORM_32	[2]	WO	This bit is used to control address formatting when reading the VA_FORM register. See the section on the VA_FORM register for details.
VA_48	[1]	WO,0	This bit controls the format applied to effective virtual addresses by the VA_FORM register and the memory pipe virtual address sign extension checkers. When VA_48 is clear, the 43-bit virtual address format is used, and when VA_48 is set, the 48-bit virtual address format is used. When VA_48 is set, the sign extension checkers generate an access control violation (ACV) if VA[63:0] ≠ SEXT(VA[47:0]). When VA_48 is clear, the sign extension checkers generate an ACV if VA[63:0] ≠ SEXT(VA[42:0]).
B_ENDIAN	[0]	WO	Big Endian Mode. When set, the shift amount (Rbv[2:0]) is inverted for EXTxx, INSxx, and MSKxx instructions. The lower bits of the physical address for Dstream accesses are inverted based upon the length of the reference as follows: Byte: Invert bits [2:0] Word: Invert bits [2:1] Longword: Inverts bit [2]

5.1.5 Virtual Address Format Register – VA_FORM

The virtual address format register (VA_FORM) is a read-only register. It contains the virtual page table entry address derived from the faulting virtual address stored in the VA register. It also contains the virtual page table base and associated control bits stored in the VA_CTL register.

Figure 5–5 shows VA_FORM when VA_CTL(VA_48) equals 0 and VA_CTL(VA_FORM_32) equals 0.

Figure 5–5 Virtual Address Format Register (VA_48 = 0, VA_FORM_32 = 0)

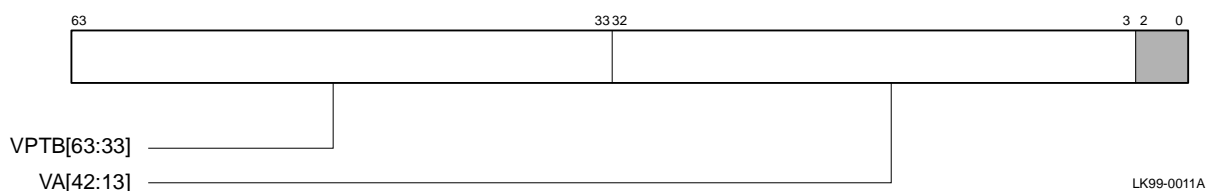

Figure 5–6 shows VA_FORM when VA_CTL(VA_48) equals 1 and VA_CTL(VA_FORM_32) equals 0.

Figure 5–6 Virtual Address Format Register (VA_48 = 1, VA_FORM_32 = 0)

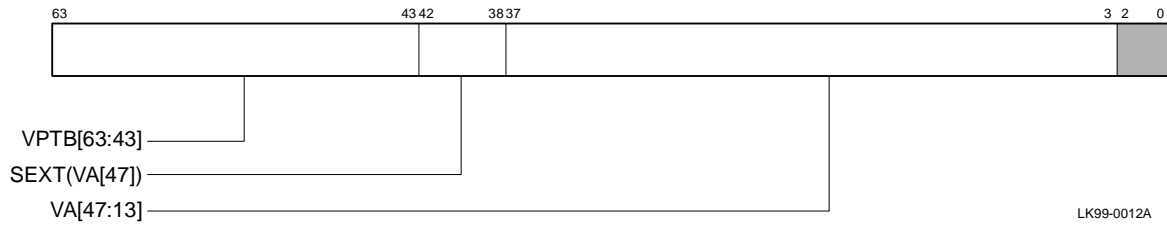
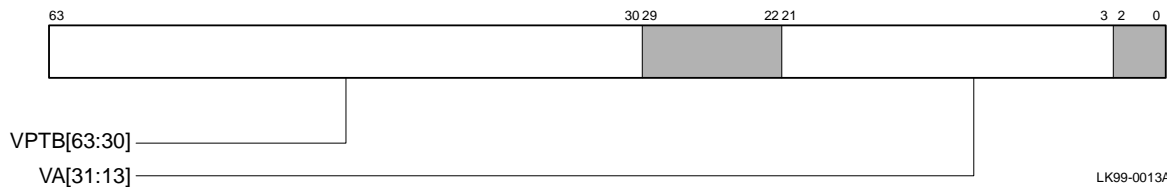

Figure 5–7 shows VA_FORM when VA_CTL(VA_48) equals 0 and VA_CTL(VA_FORM_32) equals 1.

Figure 5–7 Virtual Address Format Register (VA_48 = 0, VA_FORM_32 = 1)



5.2 Ibox IPRs

This section describes the internal processor registers that control Ibox functions.

5.2.1 ITB Tag Array Write Register – ITB_TAG

The ITB tag array write register (ITB_TAG) is a write-only register. The ITB tag array is written by way of this register. A write transaction to ITB_TAG writes a register outside the ITB array. When a write to the ITB_PTE register is retired, the contents of both the ITB_TAG and ITB_PTE registers are written into the ITB entry. The specific ITB entry that is written is determined by a round-robin algorithm; the algorithm writes to entry number 0 as the first entry after the 21264/EV68A is reset. Figure 5–8 shows the ITB tag array write register.

Figure 5–8 ITB Tag Array Write Register

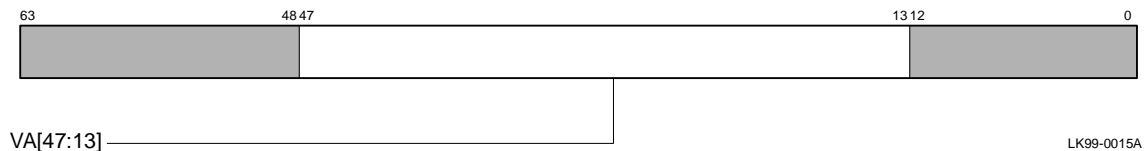

5.2.2 ITB PTE Array Write Register – ITB_PTE

The ITB PTE array write register (ITB_PTE) is a write-only register through which the ITB PTE array is written. A round-robin allocation algorithm is used. A write to the ITB_PTE array, when retired, results in both the ITB_TAG and ITB_PTE arrays being written. The specific entry that is written is chosen by the round-robin algorithm described above. Figure 5–9 shows the ITB PTE array write register.

Figure 5–9 ITB PTE Array Write Register

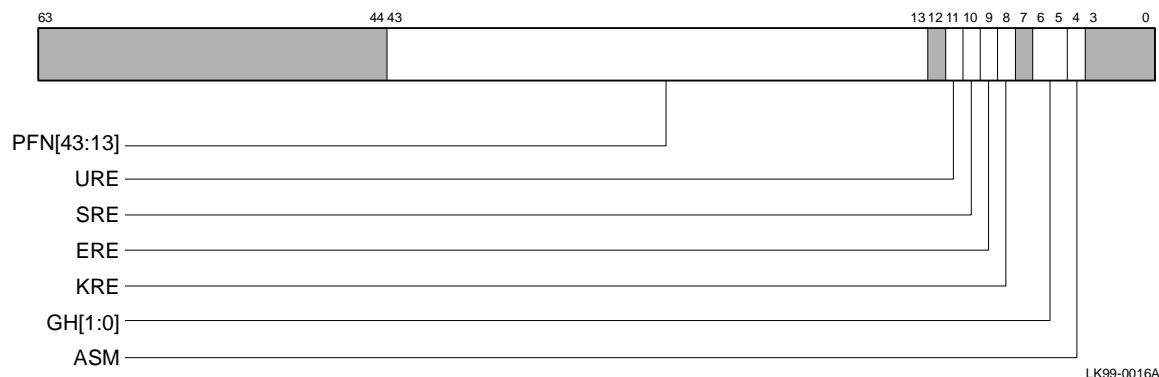

5.2.3 ITB Invalidate All Process (ASM=0) Register – ITB_IAP

The ITB invalidate all process register (ITB_IAP) is a pseudo register that, when written to, invalidates all ITB entries whose ASM bit is clear. An explicit write to IC_FLUSH_ASM is required to flush the Icache of blocks with ASM equal to zero.

5.2.4 ITB Invalidate All Register – ITB_IA

The ITB invalidate all register (ITB_IA) is a pseudo register that, when written to, invalidates all ITB entries. An explicit write to IC_FLUSH is required to flush the Icache.

5.2.5 ITB Invalidate Single Register – ITB_IS

The ITB invalidate single register (ITB_IS) is a write-only register. Writing a virtual page number to this register invalidates any ITB entry that meets one of the following criteria:

- The ITB entry's virtual page number matches ITB_IS[47:13] (or fewer bits if granularity hint bits are set in the ITB entry) and its ASN field matches the address space number supplied in PCTX[46:39].
- The ITB entry's virtual page number matches ITB_IS[47:13] and its ASM bit is set.

Figure 5–10 shows the ITB invalidate single register.

Figure 5–10 ITB Invalidate Single Register

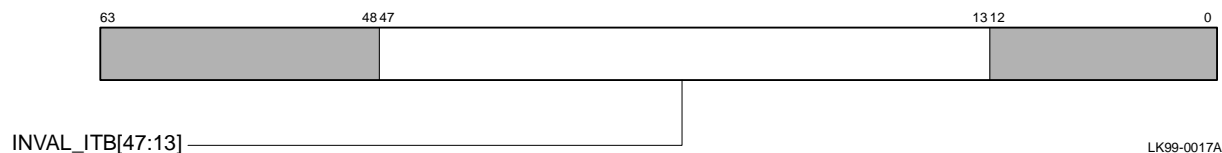

Note: Because the Icache is virtually indexed and tagged, it is normally not necessary to flush the Icache when paging. Therefore, a write to ITB_IS will not flush the Icache.

5.2.6 ProfileMe PC Register – PMPC

The ProfileMe PC register (PMPC) is a read-only register that contains the PC of the last profiled instruction. Additional information is available in the I_STAT and PCTR_CTL register descriptions.

Usage of PMPC in performance monitoring is described in Section 6.10.

Figure 5–11 shows the ProfileMe PC register.

Figure 5–11 ProfileMe PC Register

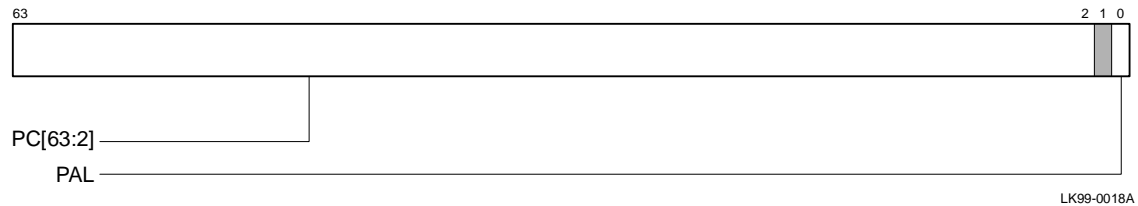

Table 5–4 describes the ProfileMe PC register fields.

Table 5–4 ProfileMe PC Fields Description

Name	Extent	Type	Description
PC[63:2]	[63:2]	RO	Address of the profiled instruction
Reserved	[1]	RO	Read as zero
PAL	[0]	RO	Indicates that the PC field contains a physical-mode PALmode address

5.2.7 Exception Address Register – EXC_ADDR

The exception address register (EXC_ADDR) is a read-only register that is updated by hardware when it encounters an exception or interrupt.

EXC_ADDR[0] is set if the associated exception occurred in PALmode. The exception actions are listed here:

- If the exception was a fault or a synchronous trap, EXC_ADDR contains the PC of the instruction that triggered the fault or trap.
- If the exception was an interrupt, EXC_ADDR contains the PC of the next instruction that would have executed if the interrupt had not occurred.

Figure 5–12 shows the exception address register.

Figure 5–12 Exception Address Register

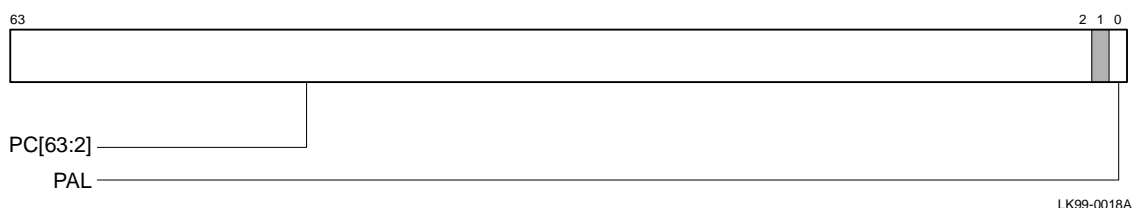

5.2.8 Instruction Virtual Address Format Register — IVA_FORM

The instruction virtual address format register (IVA_FORM) is a read-only register. It contains the virtual PTE address derived from the faulting virtual address stored in the EXC_ADDR register, and from the virtual page table base, VA_48 and VA_FORM_32 bits, stored in the I_CTL register.

Figure 5–13 shows IVA_FORM when I_CTL(VA_48) equals 0 and I_CTL(VA_FORM_32) equals 0.

Figure 5–13 Instruction Virtual Address Format Register (VA_48 = 0, VA_FORM_32 = 0)

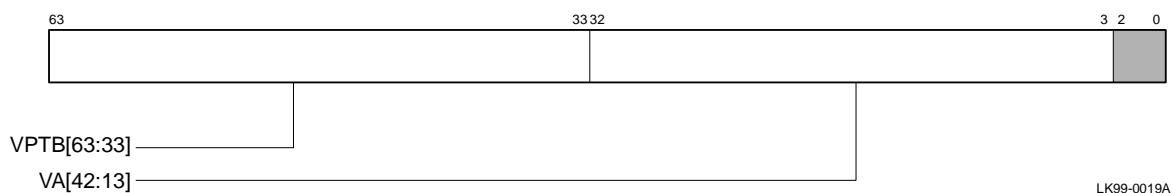

Figure 5–14 shows IVA_FORM when I_CTL(VA_48) equals 1 and I_CTL(VA_FORM_32) equals 0.

Figure 5–14 Instruction Virtual Address Format Register (VA_48 = 1, VA_FORM_32 = 0)

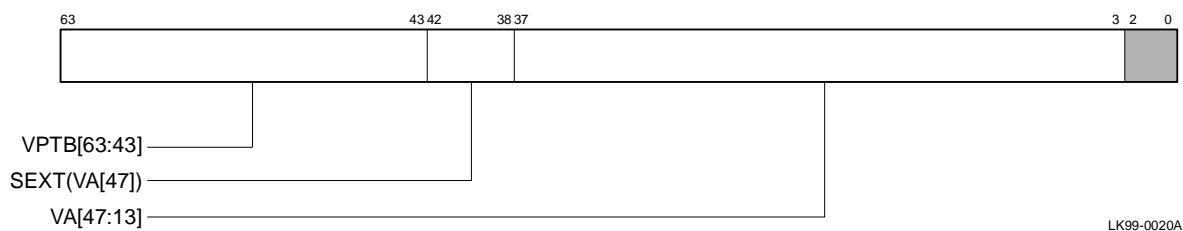
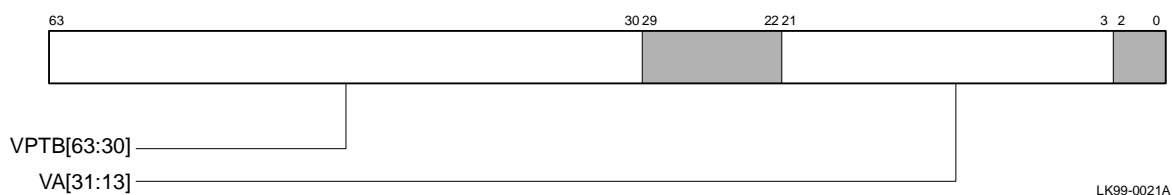

Figure 5–15 shows IVA_FORM when I_CTL(VA_48) equals 0 and I_CTL(VA_FORM_32) equals 1.

Figure 5–15 Instruction Virtual Address Format Register (VA_48 = 0, VA_FORM_32 = 1)



5.2.9 Interrupt Enable and Current Processor Mode Register – IER_CM

The interrupt enable and current processor mode register (IER_CM) contains the interrupt enable and current processor mode bit fields. These bit fields can be written either individually or together with a single HW_MTPR instruction. When bits [7:2] of the IPR index field of a HW_MTPR instruction contain the value 000010₂, this register is selected. Bits [1:0] of the IPR index indicate which bit fields are to be written: bit[1] corresponds to the IER field and bit[0] corresponds to the processor mode field. A HW_MFPR instruction to this register returns the values in both fields. Figure 5–16 shows the interrupt enable and current processor mode register.

Figure 5–16 Interrupt Enable and Current Processor Mode Register

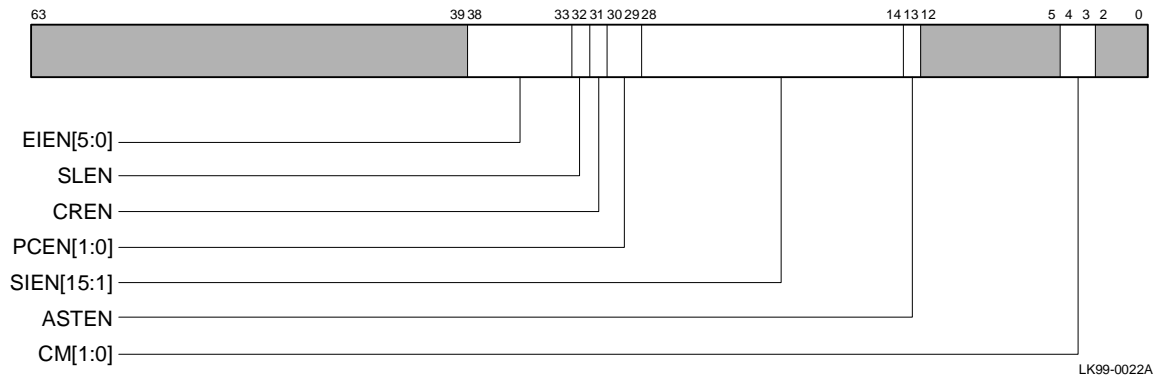

Table 5–5 describes the interrupt enable and current processor mode register fields.

Table 5–5 IER_CM Register Fields Description

Name	Extent	Type	Description
Reserved	[63:39]	—	—
EIEN[5:0]	[38:33]	RW	External Interrupt Enable
SLEN	[32]	RW	Serial Line Interrupt Enable
CREN	[31]	RW	Corrected Read Error Interrupt Enable
PCEN[1:0]	[30:29]	RW	Performance Counter Interrupt Enables
SIEN[15:1]	[28:14]	RW	Software Interrupt Enables
ASTEN	[13]	RW	AST Interrupt Enable When set, enables those AST interrupt requests that are also enabled by the value in ASTER.
Reserved	[12:5]	—	—
CM[1:0]	[4:3]	RW	Current Mode 00 Kernel 01 Executive 10 Supervisor 11 User
Reserved	[2:0]	—	—

5.2.10 Software Interrupt Request Register – SIRR

The software interrupt request register (SIRR) is a read-write register containing bits to request software interrupts. To generate a particular software interrupt, its corresponding bits in SIRR and IER[SIER] must both be set. Figure 5–17 shows the software interrupt request register.

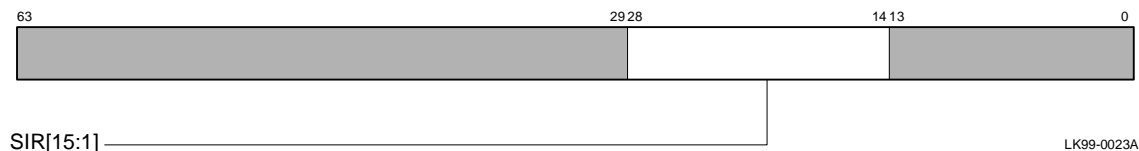
Figure 5–17 Software Interrupt Request Register

LK99-0023A

Table 5–6 describes the software interrupt request register fields.

Table 5–6 Software Interrupt Request Register Fields Description

Name	Extent	Type	Description
Reserved	[63:29]	—	—
SIR[15:1]	[28:14]	RW	Software Interrupt Requests
Reserved	[13:0]	—	—

5.2.11 Interrupt Summary Register – ISUM

The interrupt summary register (ISUM) is a read-only register that records all pending hardware, software, and AST interrupt requests that have their corresponding enable bit set.

If a new interrupt (hardware, serial line, crd, or performance counters) occurs simultaneously with an ISUM read, the ISUM read returns zeros. That condition is normally assumed to be a passive release condition. The interrupt is signaled again when the PALcode returns to native mode. The effects of this condition can be minimized by reading ISUM twice and ORing the results.

Usage of ISUM in performance monitoring is described in Section 6.10. Figure 5–18 shows the interrupt summary register.

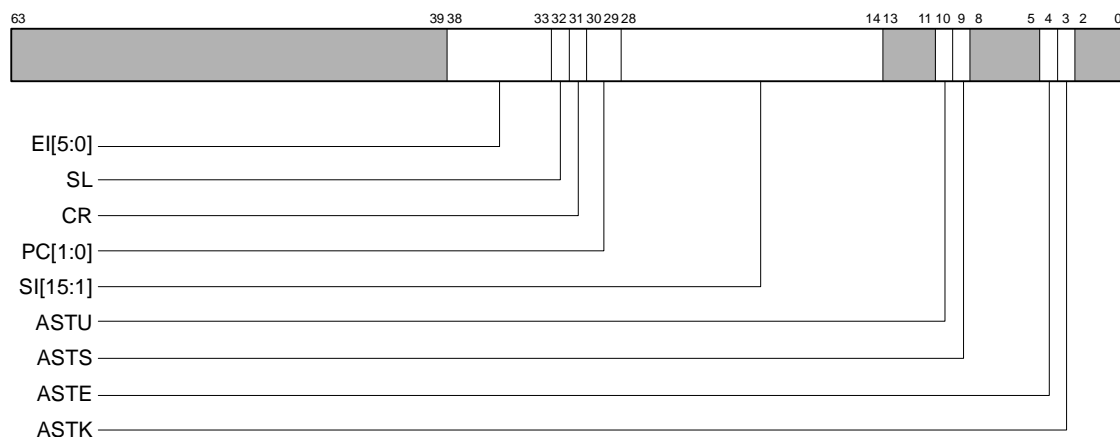
Figure 5–18 Interrupt Summary Register

LK99-0024A

Table 5–7 describes the interrupt summary register fields.

Table 5–7 Interrupt Summary Register Fields Description

Name	Extent	Type	Description
Reserved	[63:39]	—	—
EI[5:0]	[38:33]	RO	External Interrupts
SL	[32]	RO	Serial Line Interrupt
CR	[31]	RO	Corrected Read Error Interrupts
PC[1:0]	[30:29]	RO	Performance Counter Interrupts PC0 when PC[0] is set. PC1 when PC[1] is set.
SI[15:1]	[28:14]	RO	Software Interrupts
Reserved	[13:11]	—	—
ASTU, ASTS	[10],[9]	RO	AST Interrupts For each processor mode, the bit is set if an associated AST interrupt is pending. This includes the mode's ASTER and ASTRR bits and whether the processor mode value held in the IER_CM register is greater than or equal to the value for the mode.
Reserved	[8:5]	—	—
ASTE, ASTK	[4],[3]	RO	AST Interrupts For each processor mode, the bit is set if an associated AST interrupt is pending. This includes the mode's ASTER and ASTRR bits and whether the processor mode value held in the IER_CM register is greater than or equal to the value for the mode.
Reserved	[2:0]	—	—

5.2.12 Hardware Interrupt Clear Register – HW_INT_CLR

The hardware interrupt clear register (HW_INT_CLR) is a write-only register used to clear edge-sensitive interrupt requests. See Section D.31 for more information about the PALcode restriction concerning this register. Figure 5–19 shows the hardware interrupt clear register.

Figure 5–19 Hardware Interrupt Clear Register

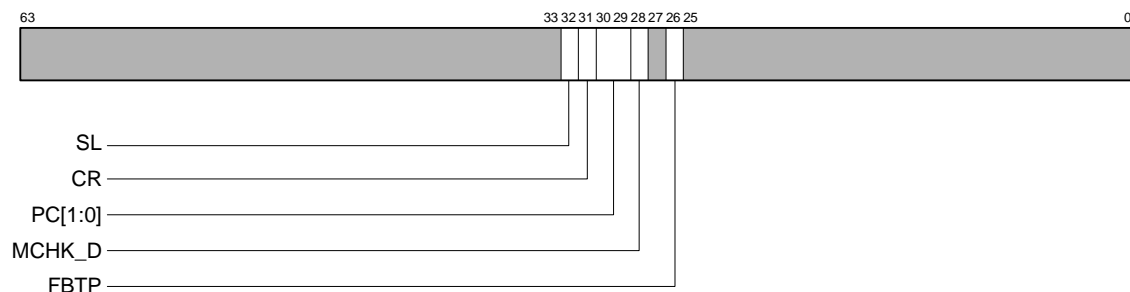

LK99-0025A

Table 5–8 describes the hardware interrupt clear register fields.

Table 5–8 Hardware Interrupt Clear Register Fields Description

Name	Extent	Type	Description
Reserved	[63:33]	—	—
SL	[32]	W1C	Clears serial line interrupt request
CR	[31]	W1C	Clears corrected read error interrupt request
PC[1:0]	[30:29]	W1C	Clears performance counter interrupt requests
MCHK_D	[28]	W1C	Clears Dstream machine check interrupt request
Reserved	[27]	—	—
FBTP	[26]	W1S	Forces the next Bcache hit that fills the Icache to generate bad Icache fill parity
Reserved	[25:0]	—	—

5.2.13 Exception Summary Register – EXC_SUM

The exception summary register (EXC_SUM) is a read-only register that contains information about instructions that have triggered traps. The register is updated at trap delivery time. Its contents are valid only if it is read (by way of a HW_MFPR) in the first fetch block of the exception handler. There are three types of traps for which this register captures related information:

- **Arithmetic traps:** The instruction generated an exceptional condition that should be reported to the operating system, and/or the FPCR status bit associated with this condition is clear and should be set by PALcode. Additionally, the REG field contains the register number of the destination specifier for the instruction that triggered the trap.
- **Istream ACV:** The BAD_IVA bit of this register indicates whether the offending Istream virtual address is latched into the EXC_ADDR register or the VA register.
- **Dstream exceptions:** The REG field contains the register number of either the source specifier (for stores) or the destination specifier (for loads) of the instruction that triggered the trap.

Figure 5–20 shows the exception summary register.

Figure 5–20 Exception Summary Register

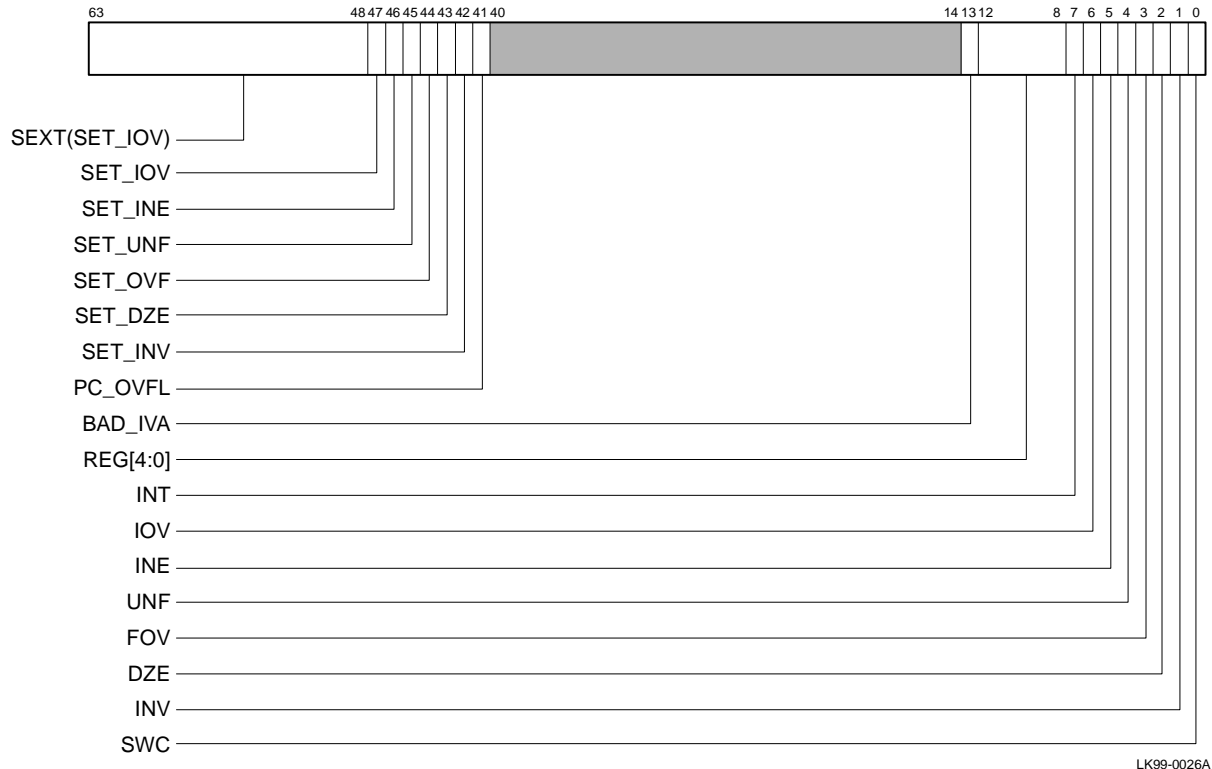

LK99-0026A

Table 5–9 describes the exception summary register fields.

Table 5–9 Exception Summary Register Fields Description

Name	Extent	Type	Description
SEXT(SET_IOV)	[63:48]	RO, 0	Sign-extended value of bit 47, SET_IOV.
SET_IOV	[47]	RO	PALcode should set FPCR[IOV].
SET_INE	[46]	RO	PALcode should set FPCR[INE].
SET_UNF	[45]	RO	PALcode should set FPCR[UNF].
SET_OVF	[44]	RO	PALcode should set FPCR[OVF].
SET_DZE	[43]	RO	PALcode should set FPCR[DZE].
SET_INV	[42]	RO	PALcode should set FPCR[INV].
PC_OVFL	[41]	RO	Indicates that EXC_ADDR was improperly sign extended for 48-bit mode over/underflow IACV.
Reserved	[40:14]	RO, 0	Reserved for COMPAQ.
BAD_IVA	[13]	RO	Bad Istream VA. This bit should be used by the IACV PALcode routine to determine whether the offending I-stream virtual address is latched in the EXC_ADDR register or the VA register. If BAD_IVA is clear, EXC_ADDR contains the address; if BAD_IVA is set, VA contains the address.

Table 5–9 Exception Summary Register Fields Description (Continued)

Name	Extent	Type	Description
REG[4:0]	[12:8]	RO	Destination register of load or operate instruction that triggered the trap OR source register of store that triggered the trap. These bits may contain the Rc field of an operate instruction or the Ra field of a load or store instruction. The value is UNPREDICTABLE if the trap was triggered by an ITB miss, interrupt, OPCDEC, or other non load/st/operate.
INT	[7]	RO	Set to indicate Ebox integer overflow trap, clear to indicate Fbox trap condition.
IOV	[6]	RO	Indicates Fbox convert-to-integer overflow or Ebox integer overflow trap.
INE	[5]	RO	Indicates floating-point inexact error trap.
UNF	[4]	RO	Indicates floating-point underflow trap.
FOV	[3]	RO	Indicates floating-point overflow trap.
DZE	[2]	RO	Indicates divide by zero trap.
INV	[1]	RO	Indicates invalid operation trap.
SWC	[0]	RO	Indicates software completion possible. This bit is set if the instruction that triggered the trap contained the /S modifier.

5.2.14 PAL Base Register – PAL_BASE

The PAL base register (PAL_BASE) is a read-write register that contains the base physical address for PALcode. Its contents are cleared by chip reset but are not cleared after waking up from sleep mode or from fault reset. Figure 5–21 shows the PAL base register.

Figure 5–21 PAL Base Register

Table 5–10 describes the PAL base register fields.

Table 5–10 PAL Base Register Fields Description

Name	Extent	Type	Description
Reserved	[63:44]	RO, 0	Reserved for COMPAQ.
PAL_BASE[43:15]	[43:15]	RW	Base physical address for PALcode.
Reserved	[14:0]	RO, 0	Reserved for COMPAQ.

5.2.15 Ibox Control Register – I_CTL

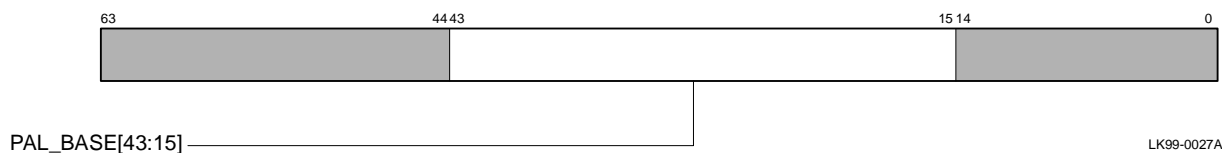
The Ibox control register (I_CTL) is a read-write register that controls various Ibox functions. Its contents are cleared by chip reset. Figure 5–22 shows the Ibox control register.

Figure 5–22 Ibox Control Register

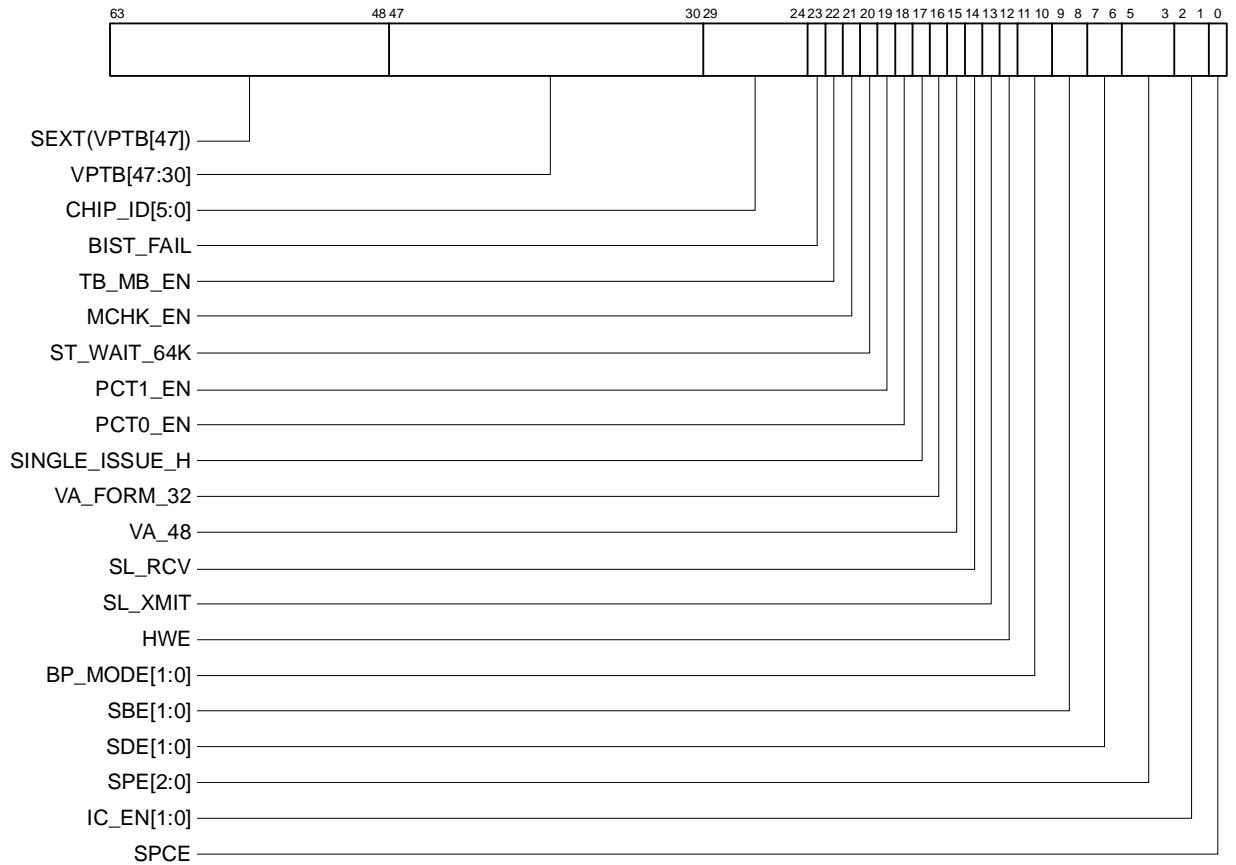

LK99-0029A

Table 5–11 describes the Ibox control register fields.

Table 5–11 Ibox Control Register Fields Description

Name	Extent	Type	Description
SEXT(VPTB[47])	[63:48]	RW,0	Sign extended VPTB[47].
VPTB[47:30]	[47:30]	RW,0	Virtual Page Table Base. See Section 5.1.5 for details.
CHIP_ID[5:0]	[29:24]	RO	This is a read-only field that supplies the revision ID number for the 21264/EV68A part. 21264/EV68A pass 2.1 ID is 010010 ₂ .
BIST_FAIL	[23]	RO,0	Indicates the status of BiST (clear = pass, set = fail), described in Section 11.5.1.
TB_MB_EN	[22]	RW,0	When set, the hardware ensures that the virtual-mode loads in DTB and ITB fill flows that access the page table and the subsequent virtual mode load or store that is being retried are ‘ordered’ relative to another processor’s stores. This must be set for multiprocessor systems in which no MB instruction is present in the TB fill flow, unless there are other mechanisms present that ensure coherency.
MCHK_EN	[21]	RW,0	Machine check enable — set to enable machine checks.

Table 5–11 Ibox Control Register Fields Description (Continued)

Name	Extent	Type	Description
ST_WAIT_64K	[20]	RW,0	The stWait table is used to reduce load/store order traps. When set, the stWait table is cleared after 64K cycles. When clear, the stWait table is cleared after 16K cycles. See Section 2.11.
PCT1_EN	[19]	RW,0	Enable performance counter #1. If this bit is one, the performance counter will count if either the system (SPCE) or process (PPCE) performance counter enable is asserted.
PCT0_EN	[18]	RW,0	Enable performance counter #0. If this bit is one, the performance counter will count if EITHER the system (SPCE) or process (PPCE) performance counter enable is set.
SINGLE_ISSUE_H	[17]	RW,0	When set, this bit forces instructions to issue only from the bottom-most entries of the IQ and FQ.
VA_FORM_32	[16]	RW,0	This bit controls address formatting on a read of the IVA_FORM register.
VA_48	[15]	RW,0	This bit controls the format applied to effective virtual addresses by the IVA_FORM register and the Ibox virtual address sign extension checkers. When VA_48 is clear, 43-bit virtual address format is used, and when VA_48 is set, 48-bit virtual address format is used. The effect of this bit on the IVA_FORM register is identical to the effect of VA_CTL[VA_48] on the VA_FORM register. See Section 5.1.5. When VA_48 is set, the sign extension checkers generate an ACV if $va[63:0] \neq \text{SEXT}(va[47:0])$. When VA_48 is clear, the sign extension checkers generate an ACV if $va[63:0] \neq \text{SEXT}(va[42:0])$. This bit also affects DTB_DOUBLE traps. If set, the DTB double miss traps vector to the DTB_DOUBLE_4 entry point. DTB_DOUBLE PALcode flow selection is not affected by VA_CTL[VA_48].
SL_RCV	[14]	RO	See Section 11.2.
SL_XMIT	[13]	WO	When set, drives a value on SromClk_H . See Section 11.2.
HWE	[12]	RW,0	If set, allow PALRES intructions to be executed in kernel mode. Note that modification of the ITB while in kernel mode/native mode may cause UNPREDICTABLE behavior.
BP_MODE[1:0]	[11:10]	RW,0	Branch Prediction Mode Selection. BP_MODE[1], if set, forces all branches to be predicted to fall through. If clear, the dynamic branch predictor is chosen. BP_MODE[0]. If set, the dynamic branch predictor chooses local history prediction. If clear, the dynamic branch predictor chooses local or global prediction based on the state of the chooser.
SBE[1:0]	[9:8]	RW,0	Stream Buffer Enable. The value in this bit field specifies the number of Istream buffer prefetches (besides the demand-fill) that are launched after an Icache miss. If the value is zero, only demand requests are launched.

Table 5–11 Ibox Control Register Fields Description (Continued)

Name	Extent	Type	Description
SDE[1:0]	[7:6]	RW,0	PALshadow Register Enable. Enables access to the PALshadow registers. If SDE[1] is set, R4-R7 and R20-R23 are used as PALshadow registers. SDE[0] does not affect 21264/EV68A operation.
SPE[2:0]	[5:3]	RW,0	Super Page Mode Enable. Identical to the SPE bits in the Mbox M_CTL SPE[2:0]. See Section 5.3.9.
IC_EN[1:0]	[2:1]	RW,3	Icache Set Enable. At least one set must be enabled. The entire cache may be enabled by setting both bits. Zero, one, or two Icache sets can be enabled. This bit does not clear the Icache, but only disables fills to the affected set.
SPCE	[0]	RW,0	System Performance Counting Enable. Enables performance counting for the entire system if individual counters (PCTR0 or PCTR1) are enabled by setting PCT0_EN or PCT1_EN, respectively. Performance counting for individual processes can be enabled by setting PCTX[PPCE]. See Section 5.2.21 for more information. See Section 6.10 for information about performance counting.

5.2.16 Ibox Status Register – I_STAT

The Ibox status register (I_STAT) is a read/write-1-to-clear register that contains Ibox status information.

Usage of I_STAT in performance monitoring is described in Section 6.10.

Figure 5–23 shows the Ibox status register.

Figure 5–23 Ibox Status Register

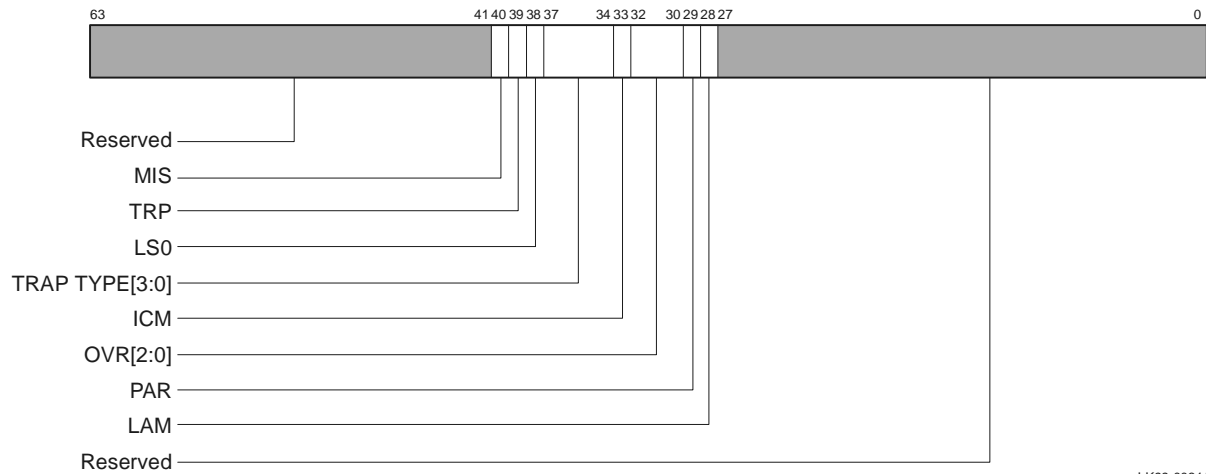

LK99-0031A

Table 5–12 describes the Ibox status register fields.

Table 5–12 Ibox Status Register Fields Description

Name	Extent	Type	Description
Reserved	[63:41]	RO	Reserved for COMPAQ.
MIS	[40]	RO	ProfileMe Mispredict Trap. If the I_STAT[TRP] bit is set, this bit indicates that the profiled instruction caused a mispredict trap. JSR/JMP/RET/COR or HW_JSR/HW_JMP/HW_RET/HW_COR mispredicts do not set this bit but can be recognized by the presence of one of these instructions at the PMPC location with the I_STAT[TRP] bit set. This identification is exact in all cases except error condition traps. Hardware corrected Icache parity or Dcache ECC errors, and machine check traps can occur on any instruction in the pipeline.
TRP	[39]	RO	ProfileMe Trap. This bit indicates that the profiled instruction caused a trap. The trap type field, PMPC register, and instruction at the PMPC location are needed to distinguish all trap types.
LS0	[38]	RO	ProfileMe Load-Store Order Trap. If the profiled instruction caused a replay trap, this bit indicates that the precise trap cause was an Mbox load-store order replay trap. If clear, this bit indicates that the replay trap was any one of the following: <ul style="list-style-type: none"> Mbox load-load order Mbox load queue full Mbox store queue full Mbox wrong size trap (such as, STL → LDQ) Mbox Bcache alias (2 physical addresses map to same Bcache line) Mbox Dcache alias (2 physical addresses map to same Dcache line) Icache parity error Dcache ECC error

Table 5–12 Ibox Status Register Fields Description (Continued)

Name	Extent	Type	Description																																										
TRAP TYPE[3:0]	[37:34]	RO	<p>ProfileMe Trap Types. If the profiled instruction caused a trap (indicated by I_STAT[TRP]), this field indicates the trap type as listed here:</p> <table border="1"> <thead> <tr> <th>Value</th> <th>Trap Type</th> </tr> </thead> <tbody> <tr><td>0</td><td>Replay</td></tr> <tr><td>1</td><td>Invalid (unused)</td></tr> <tr><td>2</td><td>DTB Double miss (3 level page tables)</td></tr> <tr><td>3</td><td>DTB Double miss (4 level page tables)</td></tr> <tr><td>4</td><td>Floating point disabled</td></tr> <tr><td>5</td><td>Unaligned Load/Store</td></tr> <tr><td>6</td><td>DTB Single miss</td></tr> <tr><td>7</td><td>Dstream Fault</td></tr> <tr><td>8</td><td>OPCDEC</td></tr> <tr><td>9</td><td>Invalid (use PMPC, described below)</td></tr> <tr><td>10</td><td>Machine Check</td></tr> <tr><td>11</td><td>Invalid (use PMPC, described below)</td></tr> <tr><td>12</td><td>Arithmetic</td></tr> <tr><td>13</td><td>Invalid (use PMPC, described below)</td></tr> <tr><td>14</td><td>MT_FPCR</td></tr> <tr><td>15</td><td>Reset</td></tr> </tbody> </table> <p>Traps due to ITB miss, Istream access violation, or interrupts are not reported in the trap type field because they do not cause pipeline aborts. Instead, these traps cause pipeline redirection and can be distinguished by examining the PMPC value for the presence of the corresponding PAL-code entry offset addresses indicated below. In these cases, the ProfileMe interrupt will normally be delivered when exiting the trap PALcode flow and the EXC_ADDR register will contain the original PC that encountered the redirect trap.</p> <table border="1"> <thead> <tr> <th>PMPC[14:0]</th> <th>Trap</th> </tr> </thead> <tbody> <tr><td>0581</td><td>ITB miss</td></tr> <tr><td>0481</td><td>Istream Access Violation</td></tr> <tr><td>0681</td><td>Interrupt</td></tr> </tbody> </table>	Value	Trap Type	0	Replay	1	Invalid (unused)	2	DTB Double miss (3 level page tables)	3	DTB Double miss (4 level page tables)	4	Floating point disabled	5	Unaligned Load/Store	6	DTB Single miss	7	Dstream Fault	8	OPCDEC	9	Invalid (use PMPC, described below)	10	Machine Check	11	Invalid (use PMPC, described below)	12	Arithmetic	13	Invalid (use PMPC, described below)	14	MT_FPCR	15	Reset	PMPC[14:0]	Trap	0581	ITB miss	0481	Istream Access Violation	0681	Interrupt
Value	Trap Type																																												
0	Replay																																												
1	Invalid (unused)																																												
2	DTB Double miss (3 level page tables)																																												
3	DTB Double miss (4 level page tables)																																												
4	Floating point disabled																																												
5	Unaligned Load/Store																																												
6	DTB Single miss																																												
7	Dstream Fault																																												
8	OPCDEC																																												
9	Invalid (use PMPC, described below)																																												
10	Machine Check																																												
11	Invalid (use PMPC, described below)																																												
12	Arithmetic																																												
13	Invalid (use PMPC, described below)																																												
14	MT_FPCR																																												
15	Reset																																												
PMPC[14:0]	Trap																																												
0581	ITB miss																																												
0481	Istream Access Violation																																												
0681	Interrupt																																												
ICM	[33]	RO	<p>ProfileMe Icache Miss. This bit indicates that the profiled instruction was contained in an aligned 4-instruction Icache fetch block that requested a new Icache fill stream.</p>																																										
OVR[2:0]	[32:30]	RO	<p>ProfileMe Counter 0 Overcount. This bit indicates a value (0-7) that must be subtracted from the counter 0 result to obtain an accurate count of the number of instructions retired in the interval beginning three cycles after the profiled instruction reaches pipeline stage 2 and ending four cycles after the profiled instruction is retired.</p>																																										
PAR	[29]	W1C	<p>Icache Parity Error. This bit indicates that the Icache encountered a parity error on instruction fetch. When a parity error is detected, the Icache is flushed, a replay trap back to the address of the error instruction is generated, and a correctable read interrupt is requested. See also I_STAT[LAM].</p>																																										
LAM	[28]	RO	<p>When set, indicates that an error in the line predictor set I_STAT[PAR]. I_STAT[LAM] is set only when I_STAT[PAR] is set; is subsequently cleared when I_STAT[PAR] is cleared (when a 1 is written to I_STAT[PAR]).</p>																																										
Reserved	[28:0]	RO	Reserved for COMPAQ.																																										

5.2.17 Icache Flush Register – IC_FLUSH

The Icache flush register (IC_FLUSH) is a pseudo register. Writing to this register invalidates all Icache blocks. The cache is flushed when the next HW_RET/STALL instruction is retired. See Section D.20 for more information.

5.2.18 Icache Flush ASM Register – IC_FLUSH_ASM

The Icache flush ASM register (IC_FLUSH_ASM) is a pseudo register. Writing to this register invalidates all Icache blocks with their ASM bit clear.

5.2.19 Clear Virtual-to-Physical Map Register – CLR_MAP

The clear virtual-to-physical map register (CLR_MAP) is a pseudo register that, when written, results in the clearing of the current map of virtual to physical registers. This register must only be written after there are no register-borne dependencies present and there are no unretired instructions. See an example in the PALcode restrictions.

5.2.20 Sleep Mode Register – SLEEP

The sleep mode register (SLEEP) is a pseudo register that, when written, results in the PLL speed being reduced and the chip entering a low-power mode. This register must only be written after a sequence of code has been run which saves all necessary state to DRAM, flushes the caches, and unmask certain interrupts so the chip can be woken up. See Section 7.3 for details.

5.2.21 Process Context Register – PCTX

The process context register (PCTX) contains information associated with the context of a process. Any combination of the bit fields within this register may be written with a single HW_MTPR instruction. When bits [7:6] of the IPR index field of a HW_MTPR instruction contain the value 01₂, this register is selected. Bits [4:0] of the IPR index indicate which bit fields are to be written. Usage of PCTX in performance monitoring is described in Section 6.10.

Table 5–13 lists the correspondence between IPR index bits and register fields.

Table 5–13 IPR Index Bits and Register Fields

IPR Index Bit	Register Field
0	ASN
1	ASTER
2	ASTRR
3	PPCE
4	FPE

A HW_MFPR from this register returns the values in all of its component bit fields.

Figure 5–24 shows the process context register.

Figure 5–24 Process Context Register

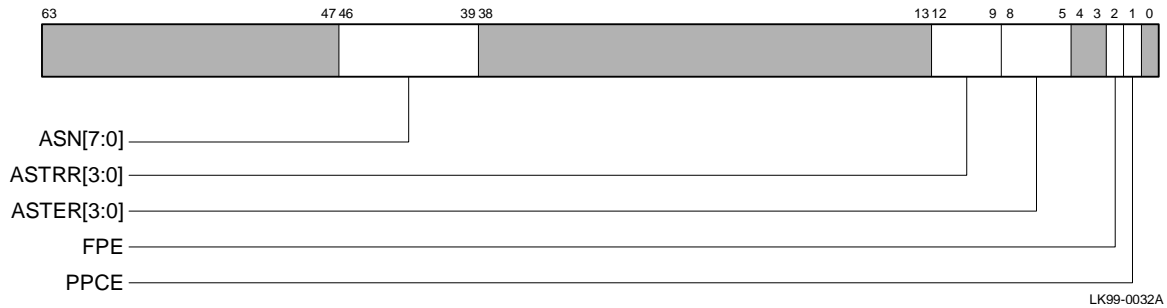

Table 5–14 describes the process context register fields.

Table 5–14 Process Context Register Fields Description

Name	Extent	Type	Description								
Reserved	[63:47]	—	—								
ASN[7:0]	[46:39]	RW	Address space number.								
Reserved	[38:13]	—	—								
ASTRR[3:0]	[12:9]	RW	AST request register—used to request AST interrupts in each of the four processor modes. To generate a particular AST interrupt, its corresponding bits in ASTRR and ASTER must be set, along with the ASTE bit in IER. Further, the value of the current mode bits in the PS register must be equal to or higher than the value of the mode associated with the AST request. The bit order with this field is: <table style="margin-left: 20px;"> <tr><td>User Mode</td><td>12</td></tr> <tr><td>Supervisor Mode</td><td>11</td></tr> <tr><td>Executive Mode</td><td>10</td></tr> <tr><td>Kernel Mode</td><td>9</td></tr> </table>	User Mode	12	Supervisor Mode	11	Executive Mode	10	Kernel Mode	9
User Mode	12										
Supervisor Mode	11										
Executive Mode	10										
Kernel Mode	9										
ASTER[3:0]	[8:5]	RW	AST enable register—used to individually enable each of the four AST interrupt requests. The bit order with this field is: <table style="margin-left: 20px;"> <tr><td>User Mode</td><td>8</td></tr> <tr><td>Supervisor Mode</td><td>7</td></tr> <tr><td>Executive Mode</td><td>6</td></tr> <tr><td>Kernel Mode</td><td>5</td></tr> </table>	User Mode	8	Supervisor Mode	7	Executive Mode	6	Kernel Mode	5
User Mode	8										
Supervisor Mode	7										
Executive Mode	6										
Kernel Mode	5										
Reserved	[4:3]	—	—								

Table 5–14 Process Context Register Fields Description (Continued)

Name	Extent	Type	Description
FPE	[2]	RW,1	Floating-point enable—if clear, floating-point instructions generate FEN exceptions. This bit is set by hardware on reset.
PPCE	[1]	RW	<p>Process performance counting enable.</p> <p>Enables performance counting for an individual process with counters PCTR0 or PCTR1, which are enabled by setting PCT0_EN or PCT1_EN, respectively.</p> <p>Performance counting for the entire system can be enabled by setting I_CTL[SPCE]. See Section 5.2.15 for more information.</p> <p>See Section 6.10 for information about performance counting.</p>
Reserved	[0]	—	—

5.2.22 Performance Counter Control Register – PCTR_CTL

The performance counter control register (PCTR_CTL) is a read-write register that controls the function of the performance counters for either aggregate counting or ProfileMe sampling counting.

Usage of PCTR_CTL in performance monitoring is described in Section 6.10.

Figure 5–25 shows the performance counter control register.

Figure 5–25 Performance Counter Control Register

Table 5–15 describes the performance counter control register fields.

Table 5–15 Performance Counter Control Register Fields Description

Name	Extent	Type	Description
SEXT(PCTR0_CTL[47])	[63:48]	RO	When read, this field is sign extended from PCTR_CTL[47]. Writes to this field are ignored.

Table 5–15 Performance Counter Control Register Fields Description (Continued)

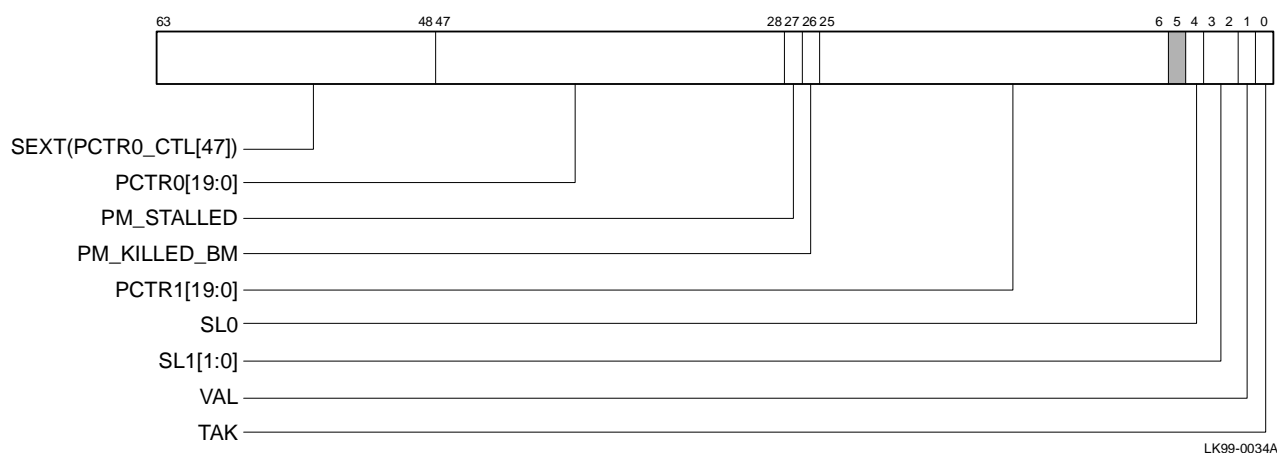
Name	Extent	Type	Description
PCTR0[19:0]	[47:28]	RW	<p>Performance counter 0. PCTR0 is enabled by I_CTL[PCT0_EN] and either I_CTL[SPCE] or PCTX[PPCE].</p> <p>In Aggregate mode: When enabled, PCTR0 is incremented at each cycle by the selected input. (See Section 6.10.2 for more information.) On overflow, if enabled by IER_CM[PCEN0], ISUM[PC0] is set and an interrupt is triggered.</p> <p>In ProfileMe mode: On overflow, a count window is opened and PCTR0 is incremented as described in Section 6.10.3. When the count window overflows, if enabled by IER_CM[PCEN0], ISUM[PC0] is set and an interrupt is triggered.</p> <p>See Table 5–16 for counter modes.</p>
PM_STALLED	[27]	RO	The profiled instruction stalled for at least one cycle between the fetch and map stages of the pipeline.
PM_KILLED_BM	[26]	RO	The profiled instruction was killed during or before the cycle in which it was mapped.
PCTR1[19:0]	[25:6]	RW	<p>Performance counter 1. PCTR1 is enabled by I_CTL[PCT1_EN] and either I_CTL[SPCE] or PCTX[PPCE].</p> <p>In Aggregate mode: When enabled, PCTR1 is incremented at each cycle by the selected input. (See Section 6.10.2 for more information.) On overflow, if enabled by IER_CM[PCEN1], ISUM[PC1] is set and an interrupt is triggered.</p> <p>In ProfileMe mode, how PCTR1 is incremented is described in Section 6.10.3.</p> <p>In either case, PCTR1 is incremented no more than 1 per cycle.</p> <p>See Table 5–16 for counter modes.</p>
Reserved	[5]	RO	Reads to this field return zero. Writes to this field are ignored.
SL0	[4]	RW	<p>Selector 0. 0 = Aggregate counting mode 1 = ProfileMe mode See Table 5–16 for more information.</p>
SL1[1:0]	[3:2]	RW	<p>Selector 1. Selects counter PCTR0 and PCTR1 modes. See Table 5–16 for more information.</p>

Table 5–15 Performance Counter Control Register Fields Description (Continued)

Name	Extent	Type	Description
VAL	[1]	RO	Profiled instruction valid. When set, indicates a nontrapping profiled instruction retired valid. When clear, indicates that a nontrapping profiled instruction was killed after the cycle in which it was mapped. Valid retire/abort status for a trapping profiled instruction is determined by the trap type (see I_STAT[TRAP_TYPE]).
TAK	[0]	RO	ProfileMe conditional branch taken. Indicates program branch direction, if the profiled instruction is a conditional branch.

Table 5–16 Performance Counter Control Register Input Select Fields

SL0[4]	SL1[3:2]	Mode	PCTR0	PCTR1
0	00	Aggregate	Retired instructions	Cycle counting
0	01	Aggregate	Cycle counting	Not defined
0	10	Aggregate	Retired instructions	Bcache miss or long latency probes
0	11	Aggregate	Cycle counting	Mbox replay traps
1	00	ProfileMe	Retired instructions	Cycle counting
1	01	ProfileMe	Cycle counting	Inum retire delay
1	10	ProfileMe	Retired instructions	Bcache miss or long latency probes
1	11	ProfileMe	Cycle counting	Mbox replay traps

5.3 Mbox IPRs

This section describes the internal processor registers that control Mbox functions.

5.3.1 DTB Tag Array Write Registers 0 and 1 – DTB_TAG0, DTB_TAG1

The DTB tag array write registers 0 and 1 (DTB_TAG0 and DTB_TAG1) are write-only registers through which the two memory pipe DTB tag arrays are written. Write transactions to DTB_TAG0 and DTB_TAG1 write data to registers outside the DTB arrays. When write transactions to the corresponding DTB_PTE registers are retired, the contents of both the DTB_TAG and DTB_PTE registers are written into their respective DTB arrays, at locations determined by the round-robin allocation algorithm. Figure 5–26 shows the DTB tag array write registers 0 and 1.

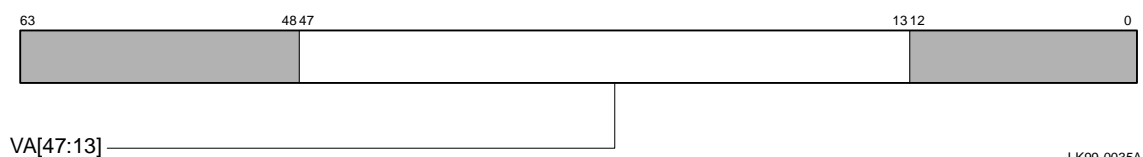
Figure 5–26 DTB Tag Array Write Registers 0 and 1

LK99-0035A

5.3.2 DTB PTE Array Write Registers 0 and 1 – DTB_PTE0, DTB_PTE1

The DTB PTE array write registers 0 and 1 (DTB_PTE0 and DTB_PTE1) are registers through which the DTB PTE arrays are written. The entries to be written are chosen by a round-robin allocation scheme. Write transactions to the DTB_PTE registers, when retired, result in both the DTB_TAG and DTB_PTE arrays being written. Figure 5–27 shows the DTB PTE array write registers 0 and 1.

Figure 5–27 DTB PTE Array Write Registers 0 and 1

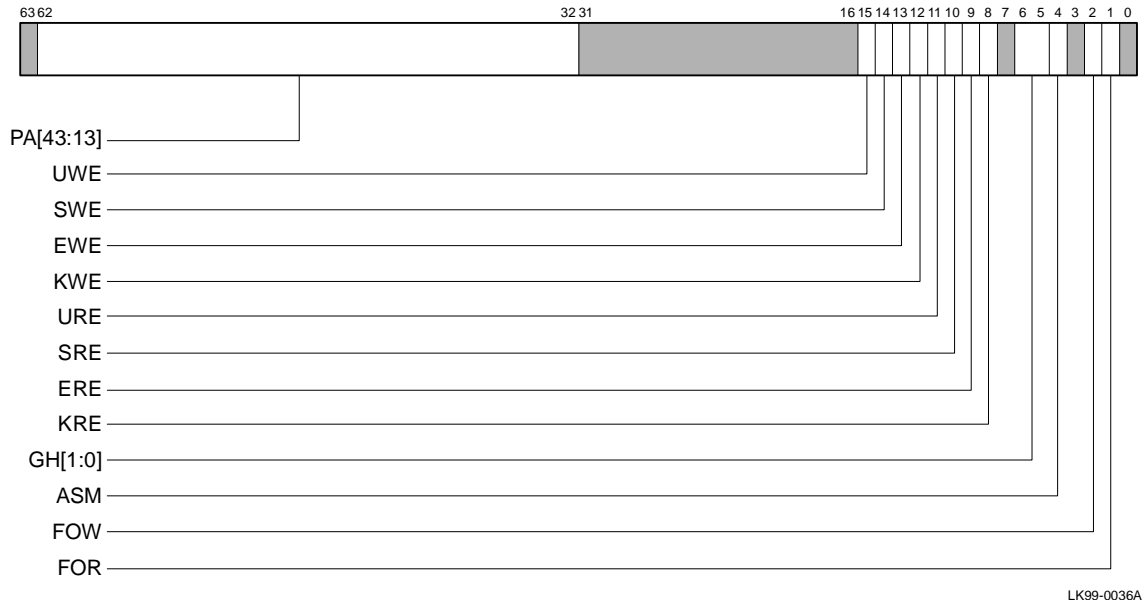

5.3.3 DTB Alternate Processor Mode Register – DTB_ALTMODE

The DTB alternate processor mode register (DTB_ALTMODE) is a write-only register whose contents specify the alternate processor mode used by some HW_LD and HW_ST instructions. Figure 5–28 shows the DTB alternate processor mode register.

Figure 5–28 DTB Alternate Processor Mode Register

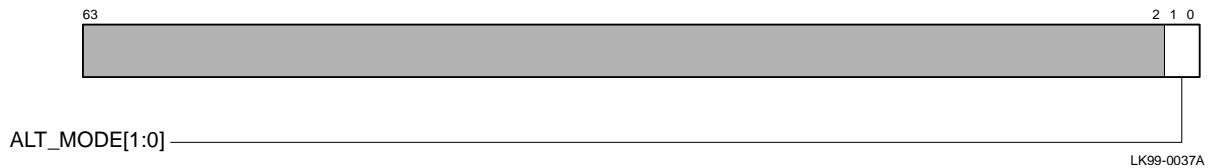

Table 5–17 describes the DTB_ALTMODE register fields.

Table 5–17 DTB Alternate Processor Mode Register Fields Description

Name	Extent	Type	Description
Reserved	[63:2]	—	—

Table 5–17 DTB Alternate Processor Mode Register Fields Description (Continued)

Name	Extent	Type	Description										
ALT_MODE[1:0]	[1:0]	WO	Alt_Mode: <table border="1"> <thead> <tr> <th>ALT_MODE[1:0]</th> <th>Mode</th> </tr> </thead> <tbody> <tr> <td>00</td> <td>Kernel</td> </tr> <tr> <td>01</td> <td>Executive</td> </tr> <tr> <td>10</td> <td>Supervisor</td> </tr> <tr> <td>11</td> <td>User</td> </tr> </tbody> </table>	ALT_MODE[1:0]	Mode	00	Kernel	01	Executive	10	Supervisor	11	User
ALT_MODE[1:0]	Mode												
00	Kernel												
01	Executive												
10	Supervisor												
11	User												

5.3.4 Dstream TB Invalidate All Process (ASM=0) Register – DTB_IAP

The Dstream translation buffer invalidate all process (ASM=0) register (DTB_IAP) is a write-only pseudo register. Write transactions to this register invalidate all DTB entries in which the address space match (ASM) bit is clear.

5.3.5 Dstream TB Invalidate All Register – DTB_IA

The Dstream translation buffer invalidate all register (DTB_IA) is a write-only pseudo register. Write transactions to this register invalidate all DTB entries and reset the DTB not-last-used pointer to its initial state.

5.3.6 Dstream TB Invalidate Single Registers 0 and 1 – DTB_IS0,1

The Dstream translation buffer invalidate single registers (DTB_IS0 and DTB_IS1) are write-only pseudo registers through which software may invalidate a single entry in the DTB arrays. Writing a virtual page number to one of these registers invalidates any DTB entry in the corresponding memory pipeline which meets one of the following criteria:

- The DTB entry's virtual page number matches DTB_IS[47:13] and its ASN field matches DTB_ASN[63:56].
- The DTB entry's virtual page number matches DTB_IS[47:13] and its ASM bit is set.

Figure 5–29 shows the Dstream translation buffer invalidate single registers.

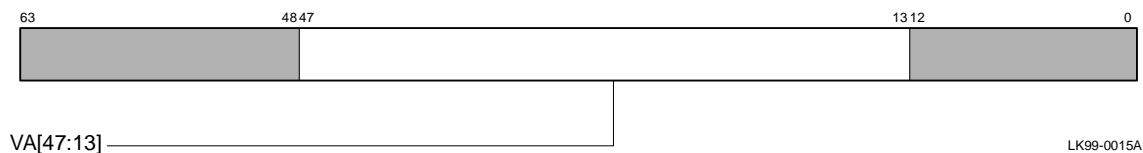
Figure 5–29 Dstream Translation Buffer Invalidate Single Registers

5.3.7 Dstream TB Address Space Number Registers 0 and 1 – DTB_ASN0,1

The Dstream translation buffer address space number registers (DTB_ASN0 and DTB_ASN1) are write-only registers that should be written with the address space number (ASN) of the current process. Figure 5–30 shows the Dstream translation buffer address space number registers 0 and 1.

Figure 5–30 Dstream Translation Buffer Address Space Number Registers 0 and 1

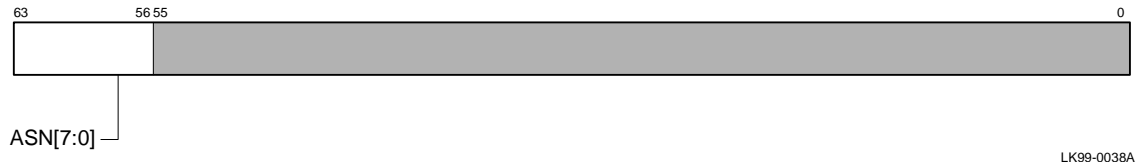

5.3.8 Memory Management Status Register – MM_STAT

The memory management status register (MM_STAT) is a read-only register. When a Dstream TB miss or fault occurs, information about the error is latched in MM_STAT. MM_STAT is not updated when a LD_VPTE gets a DTB miss instruction. Figure 5–31 shows the memory management status register.

Figure 5–31 Memory Management Status Register

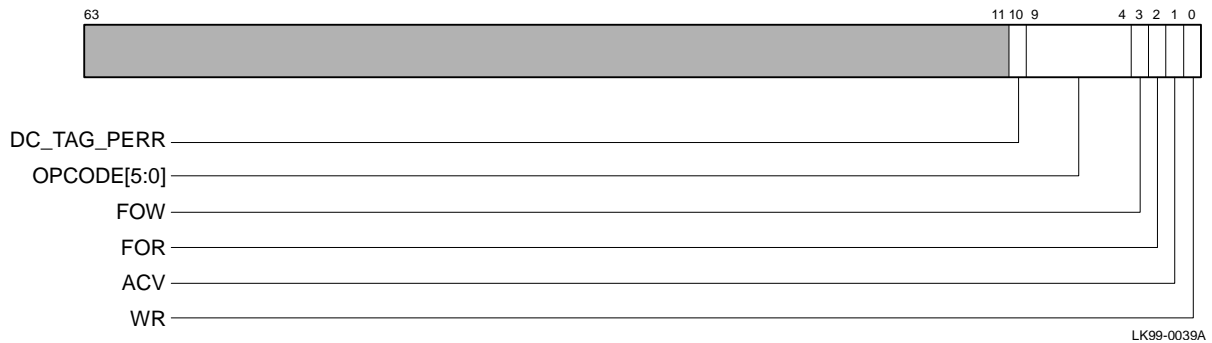

Table 5–18 describes the memory management status register fields.

Table 5–18 Memory Management Status Register Fields Description

Name	Extent	Type	Description
Reserved	[63:11]	—	—
DC_TAG_PERR	[10]	RO	This bit is set when a Dcache tag parity error occurred during the initial tag probe of a load or store instruction. The error created a synchronous fault to the D_FAULT PALcode entry point and is correctable. The virtual address associated with the error is available in the VA register.
OPCODE[5:0]	[9:4]	RO	Opcode of the instruction that caused the error. HW_LD is displayed as 3 and HW_ST is displayed as 7.
FOW	[3]	RO	This bit is set when a fault-on-write error occurs during a write transaction and PTE[FOW] was set.

Table 5–18 Memory Management Status Register Fields Description (Continued)

Name	Extent	Type	Description
FOR	[2]	RO	This bit is set when a fault-on-read error occurs during a read transaction and PTE[FOR] was set.
ACV	[1]	RO	This bit is set when an access violation occurs during a transaction. Access violations include a bad virtual address.
WR	[0]	RO	This bit is set when an error occurs during a write transaction.

Note: The Ra field of the instruction that triggered the error can be obtained from the Ibox EXC_SUM register.

5.3.9 Mbox Control Register – M_CTL

The Mbox control register (M_CTL) is a write-only register. Its contents are cleared by chip reset. Figure 5–32 shows the Mbox control register.

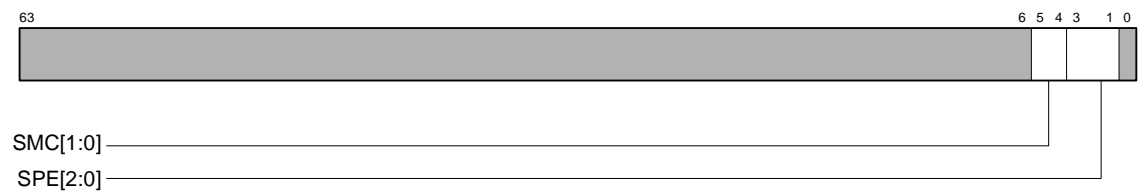
Figure 5–32 Mbox Control Register

LK99-0040A

Table 5–19 describes the Mbox control register fields.

Table 5–19 Mbox Control Register Fields Description

Name	Extent	Type	Description
Reserved	[63:6]	—	—
SMC[1:0]	[5:4]	WO,0	Speculative miss control (see Section 4.6.4). Bits Meaning When Set 00 Allow full-time speculation. 01 Force full-time conservative mode. Make retries wait until retire, force all new stores that do not hit dirty to retry, and cause prefetches with modify intent (see Section 2.6.2) to behave like normal prefetches. 10 Place 21264/EV68A in periodic conservative mode by using an 8-bit counter to add by 4 each time a branch mispredict happens and subtract by one each time a conditional branch retires. Enter conservative mode if the MSB of the counter is set. 11 Place 21264/EV68A in periodic conservative mode by using an 8-bit counter to add by 8 each time a branch mispredict happens and subtract by one each time a conditional branch retires. Enter conservative mode if the MSB of the counter is set.
SPE[2:0]	[3:1]	WO,0	Superpage mode enables. SPE[2], when set, enables superpage mapping when VA[47:46] = 2. In this mode, VA[43:13] are mapped directly to PA[43:13] and VA[45:44] are ignored. SPE[1], when set, enables superpage mapping when VA[47:41] = 7E ₁₆ . In this mode, VA[40:13] are mapped directly to PA[40:13] and PA[43:41] are copies of PA[40] (sign extension). SPE[0], when set, enables superpage mapping when VA[47:30] = 3FFFE ₁₆ . In this mode, VA[29:13] are mapped directly to PA[29:13] and PA[43:30] are cleared.
Reserved	[0]	—	—

Note: Superpage accesses are only allowed in kernel mode. Non-kernel mode references to superpages result in access violations.

5.3.10 Dcache Control Register – DC_CTL

The Dcache control register (DC_CTL) is a write-only register that controls Dcache activity. The contents of DC_CTL are initialized by chip reset as indicated. Figure 5–33 shows the Dcache control register.

Figure 5–33 Dcache Control Register

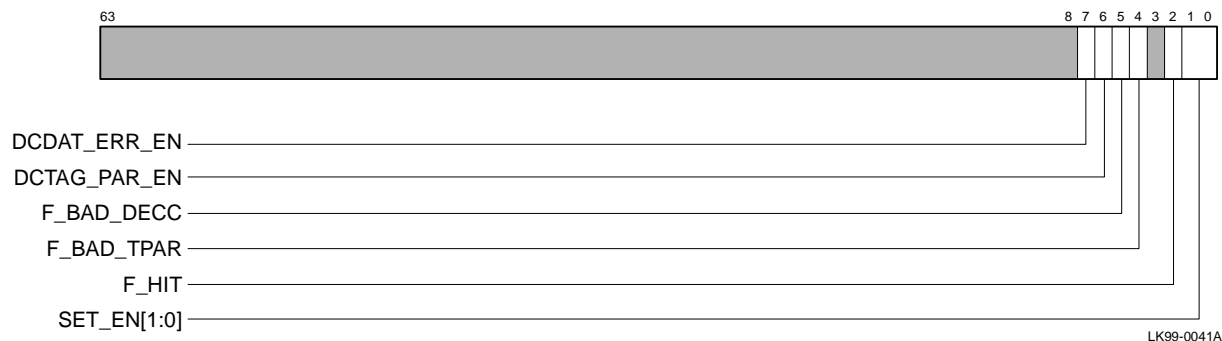

Table 5–20 describes the Dcache control register fields.

Table 5–20 Dcache Control Register Fields Description

Name	Extent	Type	Description
Reserved	[63:8]	—	—
DCDAT_ERR_EN	[7]	WO,0	Dcache data ECC and parity error enable.
DCTAG_PAR_EN	[6]	WO,0	Dcache tag parity enable.
F_BAD_DECC	[5]	WO,0	Force Bad Data ECC. When set, ECC data is <i>not</i> written into the cache along with the block that is loaded by a fill or store. Writing data that is different from that already in the block will cause bad ECC to be present. Since the old ECC value will remain, the ECC will be <i>bad</i> .
F_BAD_TPAR	[4]	WO,0	Force Bad Tag Parity. When set, this bit causes bad tag parity to be put into the Dcache tag array during Dcache fill operations.
Reserved	[3]	—	—
F_HIT	[2]	WO,0	Force Hit. When set, this bit causes all memory space load and store instructions to hit in the Dcache, independent of the Dcache tag address compare. F_HIT does not force the status of the block to register as DIRTY (the tag status bits are still consulted), so stores may still generate offchip activity. In this mode, only one of the two sets may be enabled, and tag parity checking must be disabled (set DCTAG_PER_EN to zero).
SET_EN[1:0]	[1:0]	WO,3	Dcache Set Enable. At least one set must be enabled.

5.3.11 Dcache Status Register – DC_STAT

The Dcache status register (DC_STAT) is a read-write register. If a Dcache tag parity error or data ECC error occurs, information about the error is latched in this register. Figure 5–34 shows the Dcache status register.

Cbox CSRs and IPRs

Figure 5–34 Dcache Status Register

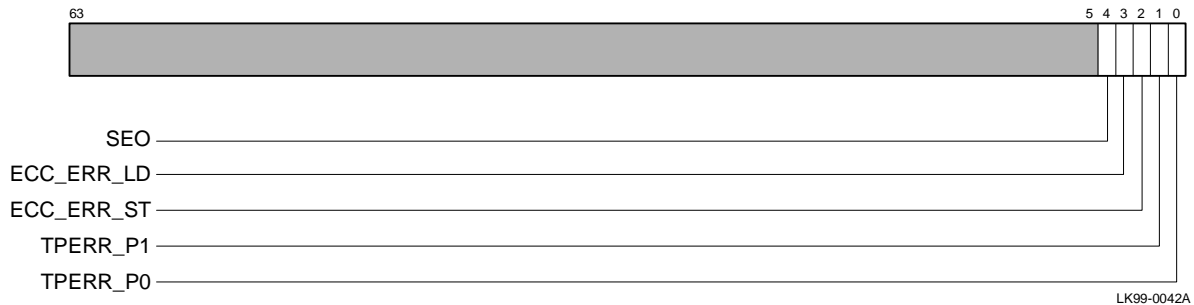

Table 5–21 describes the Dcache status register fields.

Table 5–21 Dcache Status Register Fields Description

Name	Extent	Type	Description
Reserved	[63:5]	—	—
SEO	[4]	W1C	Second error occurred. When set, this bit indicates that a second Dcache store ECC error occurred within 6 cycles of the previous Dcache store ECC error.
ECC_ERR_LD	[3]	W1C	ECC error on load. When set, this bit indicates that a single-bit ECC error occurred while processing a load from the Dcache or any fill.
ECC_ERR_ST	[2]	W1C	ECC error on store. When set, this bit indicates that an ECC error occurred while processing a store.
TPERR_P1	[1]	W1C	Tag parity error — pipe 1. When set, this bit indicates that a Dcache tag probe from pipe 1 resulted in a tag parity error. The error is uncorrectable and results in a machine check.
TPERR_P0	[0]	W1C	Tag parity error — pipe 0. When set, this bit indicates that a Dcache tag probe from pipe 0 resulted in a tag parity error. The error is uncorrectable and results in a machine check.

5.4 Cbox CSRs and IPRs

This section describes the Cbox CSRs and IPRs.

The Cbox configuration registers are split into three shift register chains:

- The hardware allocates 367 bits for the WRITE_ONCE chain, of which the 21264/EV68A uses 304 bits. During hardware reset (after BiST), 367 bits are always shifted into the WRITE_ONCE chain from the SROM, MSB first, so that the unused bits are shifted out the end of the WRITE_ONCE chain.
- A 36-bit WRITE_MANY chain that is loaded using MTPR instructions to the Cbox data register. Six bits of information are shifted into the WRITE_MANY chain during each write transaction to the Cbox data register.
- A 60-bit Cbox ERROR_REG chain that is read by using MFFR instructions from the Cbox data register in combination with MTPR instructions to the Cbox shift register. Each write transaction to the Cbox shift register destructively shifts six bits of information out of the Cbox error register.

5.4.1 Cbox Data Register – C_DATA

Figure 5–35 shows the Cbox data register.

Figure 5–35 Cbox Data Register

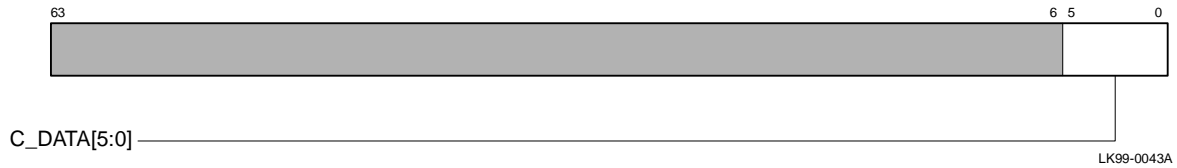

Table 5–22 describes the Cbox data register fields.

Table 5–22 Cbox Data Register Fields Description

Name	Extent	Type	Description
Reserved	[63:6]	—	—
C_DATA[5:0]	[5:0]	RW	Cbox data register. A HW_MTPR instruction to this register causes six bits of data to be placed into a serial shift register. When the HW_MTPR instruction is retired, the data is shifted into the Cbox. After the Cbox shift register has been accessed, performing a HW_MFPR instruction to this register will return six bits of data.

5.4.2 Cbox Shift Register – C_SHFT

Figure 5–36 shows the Cbox shift register.

Figure 5–36 Cbox Shift Register

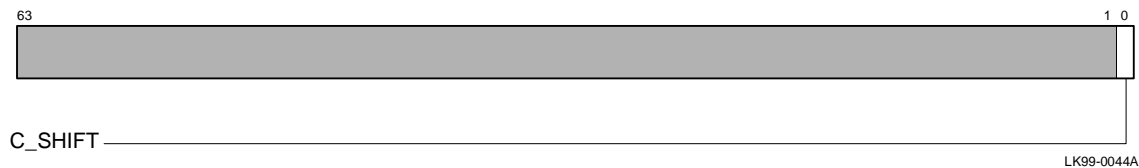

Table 5–23 describes the Cbox shift register fields.

Table 5–23 Cbox Shift Register Fields Description

Name	Extent	Type	Description
Reserved	[63:1]	—	—
C_SHIFT	[0]	W1	Writing a 1 to this register bit causes six bits of Cbox IPR data to shift into the Cbox data register. Software can then use a HW_MFPR read operation to the Cbox data register to read the six bits of data.

5.4.3 Cbox WRITE_ONCE Chain Description

The WRITE_ONCE chain order is contained in Table 5–24. In the table:

- Many CSRs are duplicated for ease of hardware implementation. These CSRs are indicated in italics. They must be written with values that are identical to the values written to the original CSRs.

Cbox CSRs and IPRs

- Only a brief description of each CSR is given. The functional description of these CSRs is contained in Chapter 4.
- The order of multibit vectors is [MSB:LSB], so the LSB is first bit in the Cbox chain.

Table 5–24 describes the Cbox WRITE_ONCE chain order from LSB to MSB.

Table 5–24 Cbox WRITE_ONCE Chain Order

Cbox WRITE_ONCE Chain	Description										
32_BYTE_IO[0]	Enable 32_BYTE I/O mode.										
BC_CLK_RATIO[1]	Asserted when Bcache is at 1.5x ratio.										
SKEWED_FILL_MODE[0]	Must be asserted for Bcache 1.5x ratio; for maximum performance, can also be asserted for 3.0x and 3.5x ratios.										
DCVIC_THRESHOLD[7:0]	Threshold of the number of Dcache victims that will accumulate before streamed write transactions to the Bcache are initiated. The Cbox can accumulate up to six victims for streamed Dcache processing. This register is programmed with the decoded value of the threshold count.										
BC_CLEAN_VICTIM[0]	Enable clean victims to the system interface.										
SYS_BUS_SIZE[1:0]	Size of SysAddOut and SysAddOut buses.										
SYS_BUS_FORMAT[0]	Indicates system bus format.										
SYS_CLK_RATIO[4:1]	Speed of system bus. <table border="1" data-bbox="803 1050 1096 1207"> <thead> <tr> <th>Code</th> <th>Multiplier</th> </tr> </thead> <tbody> <tr> <td>0001</td> <td>1.5X</td> </tr> <tr> <td>0010</td> <td>2.0X</td> </tr> <tr> <td>0100</td> <td>2.5X</td> </tr> <tr> <td>1000</td> <td>3.0X</td> </tr> </tbody> </table>	Code	Multiplier	0001	1.5X	0010	2.0X	0100	2.5X	1000	3.0X
Code	Multiplier										
0001	1.5X										
0010	2.0X										
0100	2.5X										
1000	3.0X										
DUP_TAG_ENABLE[0]	Enable duplicate tag mode in the 21264/EV68A.										
PRB_TAG_ONLY[0]	Enable probe-tag only mode in the 21264/EV68A.										
FAST_MODE_DISABLE[0]	When asserted, disables fast data movement mode.										
BC_RDVICTIM[0]	Enables RdVictim mode on the pins.										
<i>BC_CLEAN_VICTIM[0]</i>	<i>Duplicate CSR.</i>										
RDVIC_ACK_INHIBIT	Enable inhibition of incrementing acknowledge counter for RdVic commands.										
SYSBUS_MB_ENABLE	Enable MB commands offchip.										
SYSBUS_ACK_LIMIT[0:4]	Sysbus acknowledge limit CSR.										
SYSBUS_VIC_LIMIT[0:2]	Limit for victims.										
<i>BC_CLEAN_VICTIM[0]</i>	<i>Duplicate CSR.</i>										
BC_WR_WR_BUBBLE[0]	Write to write GCLK bubble.										
BC_RD_WR_BUBBLES[0:5]	Read to write GCLK bubbles for the Bcache interface.										
BC_RD_RD_BUBBLE[0]	Read to read GCLK bubble for banked Bcaches.										
BC_SJ_BANK_ENABLE	Enable bank mode for Bcache.										

Table 5–24 Cbox WRITE_ONCE Chain Order (Continued)

Cbox WRITE_ONCE Chain	Description
BC_WR_RD_BUBBLES[0:3]	Write to read GCLK bubbles.
<i>DUP_TAG_ENABLE</i>	<i>Duplicate CSR.</i>
<i>SKEWED_FILL_MODE</i>	<i>Duplicate CSR.</i>
<i>BC_RDVICTIM</i>	<i>Duplicate CSR.</i>
<i>SKEWED_FILL_MODE</i>	<i>Duplicate CSR.</i>
<i>BC_RDVICTIM</i>	<i>Duplicate CSR.</i>
<i>BC_CLEAN_VICTIM</i>	<i>Duplicate CSR.</i>
<i>DUP_TAG_MODE</i>	<i>Duplicate CSR.</i>
<i>SKEWED_FILL_MODE</i>	<i>Duplicate CSR.</i>
ENABLE_PROBE_CHECK	Enable error checking during probe processing.
SPEC_READ_ENABLE[0]	Enable speculative references to the system port.
<i>SKEWED_FILL_MODE</i>	<i>Duplicate CSR.</i>
<i>SKEWED_FILL_MODE</i>	<i>Duplicate CSR.</i>
MBOX_BC_PRB_STALL	Must be asserted when BC_RATIO = 4.0X, 5.0X, 6.0X, 7.0X, or 8.0X.
BC_LAT_DATA_PATTERN[0:31]	Bcache data latency pattern.
BC_LAT_TAG_PATTERN[0:23]	Bcache tag latency pattern.
<i>BC_RDVICTIM</i>	<i>Duplicate CSR.</i>
ENABLE_STC_COMMAND[0]	Enable STx_C instructions to the pins.
BC_LATE_WRITE_NUM[0:2]	Number of Bcache clocks to delay the data for Bcache write commands.
BC_CPU_LATE_WRITE_NUM[0:1]	Number of GCLK cycles to delay the Bcache clock/data from index.
BC_BURST_MODE_ENABLE[0]	Burst mode enable signal.
BC_PENTIUM_MODE[0]	Enable Pentium mode RAM behavior.
<i>BC_CLK_RATIO[1]</i>	<i>Duplicate CSR.</i>
BC_FRM_CLK[0]	Force all Bcache transactions to start on rising edges of the A phase of a GCLK.
BC_CLK_DELAY[0:1]	Delay of Bcache clock for 0,0,1,2 GCLK phases.
BC_DDMR_ENABLE[0]	Enables the rising edge of the Bcache forwarded clock (always enabled).
BC_DDMF_ENABLE[0]	Enable the falling edge of the Bcache forwarded clock. (always enabled).
BC_LATE_WRITE_UPPER[0]	Asserted when (BC_LATE_WRITE_NUM > 3) or ((BC_LATE_WRITE_NUM = 3) and (BC_CPU_LATE_WRITE_NUM > 1)).

Table 5–24 Cbox WRITE_ONCE Chain Order (Continued)

Cbox WRITE_ONCE Chain	Description
BC_TAG_DDM_FALL_EN[0]	Enables the update of the 21264/EV68A Bcache tag outputs based on the falling edge of the forwarded clock.
BC_TAG_DDM_RISE_EN[0]	Enables the update of the 21264/EV68A Bcache tag outputs based on the rising edge of the forwarded clock.
BC_CLKFWD_ENABLE[0]	Enable clock forwarding on the Bcache interface.
BC_RCV_MUX_CNT_PRESET[0:1]	Initial value for the Bcache clock forwarding unload pointer FIFO.
<i>BC_LATE_WRITE_UPPER[0]</i>	<i>Duplicate CSR.</i>
SYS_DDM_FALL_EN[0]	Enables the update of the 21264/EV68A system outputs based on the falling edge of the system forwarded clock.
SYS_DDM_RISE_EN[0]	Enables the update of the 21264/EV68A system outputs based on the rising edge of the system forwarded clock.
SYS_CLKFWD_ENABLE[0]	Enables clock forwarding on the system interface.
SYS_RCV_MUX_CNT_PRESET[0:1]	Initial value for the system clock forwarding unload pointer FIFO.
SYS_CLK_DELAY[0:1]	Delay of 0 to 2 phases between the forwarded clock out and address/data.
SYS_DDMR_ENABLE[0]	Enables the rising edge of the system forwarded clock (always enabled).
SYS_DDMF_ENABLE[0]	Enables the falling edge of the system forwarded clock (always enabled).
BC_DDM_FALL_EN[0]	Enables update of data/address on the rising edge of the system forwarded clock.
BC_DDM_RISE_EN[0]	Enables the update of data/address on the falling edge of the system forwarded clock.
<i>BC_CLKFWD_ENABLE</i>	<i>Duplicate CSR.</i>
<i>BC_RCV_MUX_CNT_PRESET[0:1]</i>	<i>Duplicate CSR.</i>
<i>BC_CLK_DELAY[0:1]</i>	<i>Duplicate CSR.</i>
<i>BC_DDMR_ENABLE</i>	<i>Duplicate CSR.</i>
<i>BC_DDMF_ENABLE</i>	<i>Duplicate CSR.</i>
<i>SYS_DDM_FALL_EN</i>	<i>Duplicate CSR.</i>
<i>SYS_DDM_RISE_EN</i>	<i>Duplicate CSR.</i>
<i>SYS_CLKFWD_ENABLE</i>	<i>Duplicate CSR.</i>
<i>SYS_RCV_MUX_CNT_PRESET[0:1]</i>	<i>Duplicate CSR.</i>
<i>SYS_CLK_DELAY[0:1]</i>	<i>Duplicate CSR.</i>
<i>SYS_DDMR_ENABLE</i>	<i>Duplicate CSR.</i>
<i>SYS_DDMF_ENABLE</i>	<i>Duplicate CSR.</i>
<i>BC_DDM_FALL_EN</i>	<i>Duplicate CSR.</i>
<i>BC_DDM_RISE_EN</i>	<i>Duplicate CSR.</i>

Table 5–24 Cbox WRITE_ONCE Chain Order (Continued)

Cbox WRITE_ONCE Chain	Description
<i>BC_CLKFWD_ENABLE</i>	<i>Duplicate CSR.</i>
<i>BC_RCV_MUX_CNT_PRESET[0:1]</i>	<i>Duplicate CSR.</i>
<i>SYS_DDM_FALL_EN</i>	<i>Duplicate CSR.</i>
<i>SYS_DDM_RISE_EN</i>	<i>Duplicate CSR.</i>
<i>SYS_CLKFWD_ENABLE</i>	<i>Duplicate CSR.</i>
<i>SYS_RCV_MUX_CNT_PRESET[0:1]</i>	<i>Duplicate CSR.</i>
<i>SYS_CLK_DELAY[0:1]</i>	<i>Duplicate CSR.</i>
<i>SYS_DDMR_ENABLE</i>	<i>Duplicate CSR.</i>
<i>SYS_DDMF_ENABLE</i>	<i>Duplicate CSR.</i>
<i>BC_DDM_FALL_EN</i>	<i>Duplicate CSR.</i>
<i>BC_DDM_RISE_EN</i>	<i>Duplicate CSR.</i>
<i>BC_CLKFWD_ENABLE</i>	<i>Duplicate CSR.</i>
<i>BC_RCV_MUX_CNT_PRESET[0:1]</i>	<i>Duplicate CSR.</i>
<i>BC_CLK_DELAY[0:1]</i>	<i>Duplicate CSR.</i>
<i>BC_DDMR_ENABLE</i>	<i>Duplicate CSR.</i>
<i>BC_DDMF_ENABLE</i>	<i>Duplicate CSR.</i>
<i>SYS_DDM_FALL_EN</i>	<i>Duplicate CSR.</i>
<i>SYS_DDM_RISE_EN</i>	<i>Duplicate CSR.</i>
<i>SYS_CLKFWD_ENABLE</i>	<i>Duplicate CSR.</i>
<i>SYS_RCV_MUX_CNT_PRESET[0:1]</i>	<i>Duplicate CSR.</i>
<i>SYS_CLK_DELAY[1:0]</i>	<i>Duplicate CSR.</i>
<i>SYS_DDMR_ENABLE</i>	<i>Duplicate CSR.</i>
<i>SYS_DDMF_ENABLE</i>	<i>Duplicate CSR.</i>
<i>BC_DDM_FALL_EN</i>	<i>Duplicate CSR.</i>
<i>BC_DDM_RISE_EN</i>	<i>Duplicate CSR.</i>
<i>BC_CLKFWD_ENABLE</i>	<i>Duplicate CSR.</i>
<i>BC_RCV_MUX_CNT_PRESET[1:0]</i>	<i>Duplicate CSR.</i>
<i>SYS_CLK_DELAY[0:1]</i>	<i>Duplicate CSR.</i>
<i>SYS_DDMR_ENABLE</i>	<i>Duplicate CSR.</i>
<i>SYS_DDMF_ENABLE</i>	<i>Duplicate CSR.</i>
<i>SYS_DDM_FALL_EN</i>	<i>Duplicate CSR.</i>
<i>SYS_DDM_RISE_EN</i>	<i>Duplicate CSR.</i>
<i>SYS_CLKFWD_ENABLE</i>	<i>Duplicate CSR.</i>
<i>SYS_RCV_MUX_CNT_PRESET[0:1]</i>	<i>Duplicate CSR.</i>

Table 5–24 Cbox WRITE_ONCE Chain Order (Continued)

Cbox WRITE_ONCE Chain	Description
CFR_GCLK_DELAY[0:3]	Number of GCLK cycles to delay internal ClkFwdRst.
CFR_EV6CLK_DELAY[0:2]	Number of EV6Clk_x cycles to delay internal ClkFwdRst.
CFR_FRMCLK_DELAY[0:1]	Number of FrameClk_x cycles to delay internal ClkFwdRst.
<i>BC_LATE_WRITE_NUM[0:2]</i>	<i>Duplicate CSR.</i>
<i>BC_CPU_LATE_WRITE_NUM[1:0]</i>	<i>Duplicate CSR.</i>
JITTER_CMD[0]	Add one GCLK cycle to the SYSDC write path.
<i>FAST_MODE_DISABLE[0]</i>	<i>Duplicate CSR.</i>
SYSDC_DELAY[3:0]	Number of GCLK cycles to delay SysDc fill commands before action by the Cbox.
DATA_VALID_DLY[1:0]	Number of Bcache clock cycles to delay signal SysDataInValid before sample by the Cbox.
<i>BC_DDM_FALL_EN</i>	<i>Duplicate CSR.</i>
<i>BC_DDM_RISE_EN</i>	<i>Duplicate CSR.</i>
BC_CPU_CLK_DELAY[0:1]	Delay of Bcache clock for 0, 1, 2, 3 GCLK cycles.
BC_FDBK_EN[0:7]	CSR to program the Bcache forwarded clock shift register feedback points.
BC_CLK_LD_VECTOR[0:15]	CSR to program the Bcache forwarded clock shift register load values.
BC_BPHASE_LD_VECTOR[0:3]	CSR to program the Bcache forwarded clock b-phase enables.
<i>SYS_DDM_FALL_EN</i>	<i>Duplicate CSR.</i>
<i>SYS_DDM_RISE_EN</i>	<i>Duplicate CSR.</i>
SYS_CPU_CLK_DELAY[0:1]	Delay of 0..3 GCLK cycles between the forwarded clock out and address/data.
SYS_FDBK_EN[0:7]	CSR to program the system forwarded clock shift register feedback points.
SYS_CLK_LD_VECTOR[0:15]	CSR to program the system forwarded clock shift register load values.
SYS_BPHASE_LD_VECTOR[0:3]	CSR to program the system forwarded clock b-phase enables.
SYS_FRAME_LD_VECTOR[0:4]	CSR to program the ratio between frame clock and system forwarded clock.
SYSDC_DELAY[4]	Fifth SYSDC_DELAY bit.

5.4.4 Cbox WRITE_MANY Chain Description

The WRITE_MANY chain order is contained in Table 5–25. Note the following:

- Many CSRs are duplicated for ease of hardware implementation. These CSR names are indicated in italics and have two leading asterisks.
- Only a brief description of each CSR is given. The functional description of these CSRs is contained in Chapter 3.

- The order of multibit vectors is [MSB:LSB], so the LSB is first bit in the Cbox chain.

Table 5–25 describes the Cbox WRITE_MANY chain order from LSB to MSB.

Table 5–25 Cbox WRITE_MANY Chain Order

Cbox WRITE_MANY Chain	Description	For Information:
BC_VALID_MODE	Control Bcache block parity calculation	Section 8.8
INIT_MODE[0]	Enable initialize mode	Section 7.6
BC_SIZE[3:0]	Bcache size	Table 4–42
BC_ENABLE[0]	Enable the Bcache	Table 4–42
<i>BC_ENABLE</i>	<i>Duplicate CSR</i>	Table 4–42
<i>BC_SIZE[0:3]</i>	<i>Duplicate CSR</i>	Table 4–42
<i>BC_ENABLE¹</i>	<i>Duplicate CSR</i>	Table 4–42
<i>BC_ENABLE¹</i>	<i>Duplicate CSR</i>	Table 4–42
<i>BC_ENABLE¹</i>	<i>Duplicate CSR</i>	Table 4–42
INVAL_TO_DIRTY_ENABLE[1]	WH64 acknowledges	Table 4–15
ENABLE_EVICT	Enable issue evict	Table 4–1
<i>BC_ENABLE</i>	<i>Duplicate CSR</i>	Table 4–42
INVAL_TO_DIRTY_ENABLE[0]	WH64 acknowledges	Table 4–15
<i>BC_ENABLE</i>	<i>Duplicate CSR</i>	Table 4–42
<i>BC_ENABLE</i>	<i>Duplicate CSR</i>	Table 4–42
<i>BC_ENABLE</i>	<i>Duplicate CSR</i>	Table 4–42
SET_DIRTY_ENABLE[0]	SetDirty acknowledge programming	Table 4–16
<i>INVAL_TO_DIRTY_ENABLE[0]</i>	<i>Duplicate CSR</i>	Table 4–15
SET_DIRTY_ENABLE[2:1]	SetDirty acknowledge programming	Table 4–16
BC_BANK_ENABLE[0]	Enable bank mode for Bcache	Section 4.8.5
<i>BC_SIZE[0:3]</i>	<i>Duplicate CSR</i>	Table 4–42
<i>INIT_MODE</i>	<i>Duplicate CSR</i>	Section 7.6
BC_WRT_STS[0:3]	Write status for Bcache in initialize-mode (Valid, Dirty, Shared, Parity)	Section 7.6

¹ MBZ during initialization mode; see Section 7.6 for information.

Figure 5–37 shows an example of PALcode used to write to the WRITE_MANY chain.

Figure 5–37 WRITE_MANY Chain Write Transaction Example

```

;
; Initialize the Bcache configuration in the Cbox
;
;     BC_VALID_MODE = 1
;     BC_ENABLE = 1

```

Cbox CSRs and IPRs

```
; INIT_MODE = 0
; BC_SIZE = 0xF
; INVALID_TO_DIRTY_ENABLE = 3
; ENABLE_EVICT = 1
; SET_DIRTY_ENABLE = 6
; BC_BANK_ENABLE = 1
; BC_WRT_STS = 0
;
; The value for the write_many chain is based on Table 5-25.
;
; The value is sampled from MSB, 6 bits at a time, as it is written
; to EV6__DATA. Therefore, before the value can be shifted in, it must be
; inverted on a by 6 basis. The code then writes out 6 bits at a time,
; shifting right by 6 after each write.
;
; So the following transformation is done on the write_many value:
;
; [35:30]||[29:24]||[23:18]||[17:12]||[11:06]||[05:00] =>
; [05:00]||[11:06]||[17:12]||[23:18]||[29:24]||[35:30]
;
; WRITE_MANY chain = 0x07FBFFFFD
; value to be shifted in = 0xF7FFEFFC1
;
; Before the chain can be written, I_CTL[SBE] must be disabled,
; and the code must be forced into the Icache.
;
ALIGN_CACHE_BLOCK <^x47FF041F>; align with nops

mb                                ; wait for MEM-OP's to complete
lda    r0, ^x0086(r31)            ; load I_CTL....
hw_mtpr r0, EV6__I_CTL           ; ....SDE=2, IC_EN=3, SBE=0
br     r0, .                      ; create dest address

addq   r0, #17, r0                ; finish computing dest address
hw_mtpr r31, EV6__IC_FLUSH       ; flush the Icache
bne    r31, .                    ; separate retires
hw_jmp_stall (r0)                ; force flush

ALIGN_CACHE_BLOCK <^x47FF041F>    ; align with nops

bc_config:
mb                                ; pull this block in Icache
lda    r1, ^xFFC1(r31)           ; data[15:00] = 0xFFC1
ldah   r0, ^x7FFE(r31)           ; data[31:16] = 0x7FFE
zap    r1, #^x0c, r1             ; clear out bits [31:16]

bis    r1, r0, r1                ; or in bits [31:16]
addq   r31, #6, r0               ; shift in 6 x 6 bits
bc_config_shift_in:
hw_mtpr r1, EV6__DATA           ; shift in 6 bits
subq   r0, #1, r0                ; decrement R0

beq    r0, bc_config_done        ; done if R0 is zero
srl    r1, #6, r1                ; align next 6 bits
br     r31, bc_config_shift_in  ; continue shifting
bc_config_done:
hw_mtpr r31, <EV6__MM_STAT ! 64> ; wait until last shift

beq    r31, bc_config_end        ; predicts fall thru
br     r31, .-4                  ; predict infinite loop
bis    r31, r31, r31             ; nop
bis    r31, r31, r31             ; nop

bc_config_end:
```

5.4.5 Cbox Read Register (IPR) Description

The Cbox read register is read 6 bits at a time. Table 5–26 shows the ordering from LSB to MSB.

Table 5–26 Cbox Read IPR Fields Description

Name	Description
C_SYNDROME_1[7:0]	Syndrome for upper QW in OW of victim that was scrubbed.
C_SYNDROME_0[7:0]	Syndrome for lower QW in OW of victim that was scrubbed.

Table 5–26 Cbox Read IPR Fields Description (Continued)

Name	Description																																						
C_STAT[4:0]	<p>As follows:</p> <table border="0"> <thead> <tr> <th style="text-align: left;">Bits</th> <th style="text-align: left;">Error Status</th> </tr> </thead> <tbody> <tr> <td>0 0 0 0</td> <td>Either no error, or error on a speculative load, or a Bcache victim read due to a Dcache/Bcache miss</td> </tr> <tr> <td>0 0 0 1</td> <td>BC_PERR (Bcache tag parity error)</td> </tr> <tr> <td>0 0 0 1 0</td> <td>DC_PERR (duplicate tag parity error)</td> </tr> <tr> <td>0 0 0 1 1</td> <td>DSTREAM_MEM_ERR</td> </tr> <tr> <td>0 0 1 0 0</td> <td>DSTREAM_BC_ERR</td> </tr> <tr> <td>0 0 1 0 1</td> <td>DSTREAM_DC_ERR</td> </tr> <tr> <td>0 0 1 1 X</td> <td>PROBE_BC_ERR</td> </tr> <tr> <td>0 1 0 0 0</td> <td>Reserved</td> </tr> <tr> <td>0 1 0 0 1</td> <td>Reserved</td> </tr> <tr> <td>0 1 0 1 0</td> <td>Reserved</td> </tr> <tr> <td>0 1 0 1 1</td> <td>ISTREAM_MEM_ERR</td> </tr> <tr> <td>0 1 1 0 0</td> <td>ISTREAM_BC_ERR</td> </tr> <tr> <td>0 1 1 0 1</td> <td>Reserved</td> </tr> <tr> <td>0 1 1 1 X</td> <td>Reserved</td> </tr> <tr> <td>1 0 0 1 1</td> <td>DSTREAM_MEM_DBL¹</td> </tr> <tr> <td>1 0 1 0 0</td> <td>DSTREAM_BC_DBL¹</td> </tr> <tr> <td>1 1 0 1 1</td> <td>ISTREAM_MEM_DBL¹</td> </tr> <tr> <td>1 1 1 0 0</td> <td>ISTREAM_BC_DBL¹</td> </tr> </tbody> </table> <p>¹ When the Cbox WRITE_ONCE chain bit SKEWED_FILL_MODE[0] is clear, the error status is as specified; when set, the error status applies only to first octaword of the fill, and error status for the rest of the fill is generic DOUBLE_BIT_ERROR (1XXXX).</p>	Bits	Error Status	0 0 0 0	Either no error, or error on a speculative load, or a Bcache victim read due to a Dcache/Bcache miss	0 0 0 1	BC_PERR (Bcache tag parity error)	0 0 0 1 0	DC_PERR (duplicate tag parity error)	0 0 0 1 1	DSTREAM_MEM_ERR	0 0 1 0 0	DSTREAM_BC_ERR	0 0 1 0 1	DSTREAM_DC_ERR	0 0 1 1 X	PROBE_BC_ERR	0 1 0 0 0	Reserved	0 1 0 0 1	Reserved	0 1 0 1 0	Reserved	0 1 0 1 1	ISTREAM_MEM_ERR	0 1 1 0 0	ISTREAM_BC_ERR	0 1 1 0 1	Reserved	0 1 1 1 X	Reserved	1 0 0 1 1	DSTREAM_MEM_DBL ¹	1 0 1 0 0	DSTREAM_BC_DBL ¹	1 1 0 1 1	ISTREAM_MEM_DBL ¹	1 1 1 0 0	ISTREAM_BC_DBL ¹
Bits	Error Status																																						
0 0 0 0	Either no error, or error on a speculative load, or a Bcache victim read due to a Dcache/Bcache miss																																						
0 0 0 1	BC_PERR (Bcache tag parity error)																																						
0 0 0 1 0	DC_PERR (duplicate tag parity error)																																						
0 0 0 1 1	DSTREAM_MEM_ERR																																						
0 0 1 0 0	DSTREAM_BC_ERR																																						
0 0 1 0 1	DSTREAM_DC_ERR																																						
0 0 1 1 X	PROBE_BC_ERR																																						
0 1 0 0 0	Reserved																																						
0 1 0 0 1	Reserved																																						
0 1 0 1 0	Reserved																																						
0 1 0 1 1	ISTREAM_MEM_ERR																																						
0 1 1 0 0	ISTREAM_BC_ERR																																						
0 1 1 0 1	Reserved																																						
0 1 1 1 X	Reserved																																						
1 0 0 1 1	DSTREAM_MEM_DBL ¹																																						
1 0 1 0 0	DSTREAM_BC_DBL ¹																																						
1 1 0 1 1	ISTREAM_MEM_DBL ¹																																						
1 1 1 0 0	ISTREAM_BC_DBL ¹																																						
C_STS[3:0]	<p>If C_STAT equals xxx_MEM_ERR or xxx_BC_ERR, then C_STS contains the status of the block as follows; otherwise, the value of C_STS is X:</p> <table border="0"> <thead> <tr> <th style="text-align: left;">Bit Value</th> <th style="text-align: left;">Status of Block</th> </tr> </thead> <tbody> <tr> <td>7:4</td> <td>Reserved</td> </tr> <tr> <td>3</td> <td>Parity</td> </tr> <tr> <td>2</td> <td>Valid</td> </tr> <tr> <td>1</td> <td>Dirty</td> </tr> <tr> <td>0</td> <td>Shared</td> </tr> </tbody> </table>	Bit Value	Status of Block	7:4	Reserved	3	Parity	2	Valid	1	Dirty	0	Shared																										
Bit Value	Status of Block																																						
7:4	Reserved																																						
3	Parity																																						
2	Valid																																						
1	Dirty																																						
0	Shared																																						
C_ADDR[6:42]	Address of last reported ECC or parity error. If C_STAT value is DSTREAM_DC_ERR, only bits 6:19 are valid.																																						

Privileged Architecture Library Code

This chapter describes the 21264/EV68A privileged architecture library code (PALcode). The chapter is organized as follows:

- PALcode description
- PALmode environment
- Required PALcode function codes
- Opcodes reserved for PALcode
- Internal processor register access mechanisms
- PALshadow registers
- PALcode emulation of FPCR
- PALcode entry points
- Translation buffer fill flows
- Performance counter support

6.1 PALcode Description

PALcode is macrocode that provides an architecturally-defined, operating-system-specific programming interface that is common across all Alpha microprocessors. The actual implementation of PALcode differs for each operating system. PALcode runs with privileges enabled, instruction stream (Istream) mapping disabled, and interrupts disabled. PALcode has privilege to use five special opcodes that allow functions such as physical data stream (Dstream) references and internal processor register (IPR) manipulation.

PALcode can be invoked by the following events:

- Reset
- System hardware exceptions (MCHK, ARITH)
- Memory-management exceptions
- Interrupts
- CALL_PAL instructions

PALcode has characteristics that make it appear to be a combination of microcode, ROM BIOS, and system service routines, though the analogy to any of these other items is not exact. PALcode exists for several major reasons:

PALmode Environment

- There are some necessary support functions that are too complex to implement directly in a processor chip's hardware, but that cannot be handled by a normal operating system software routine. Routines to fill the translation buffer (TB), acknowledge interrupts, and dispatch exceptions are some examples. In some architectures, these functions are handled by microcode, but the Alpha architecture is careful not to mandate the use of microcode so as to allow reasonable chip implementations.
- There are functions that must run atomically, yet involve long sequences of instructions that may need complete access to all of the underlying computer hardware. An example of this is the sequence that returns from an exception or interrupt.
- There are some instructions that are necessary for backward compatibility or ease of programming; however, these are not used often enough to dedicate them to hardware, or are so complex that they would jeopardize the overall performance of the computer. For example, an instruction that does a VAX style interlocked memory access might be familiar to someone used to programming on a CISC machine, but is not included in the Alpha architecture. Another example is the emulation of an instruction that has no direct hardware support in a particular chip implementation.

In each of these cases, PALcode routines are used to provide the function. The routines are nothing more than programs invoked at specified times, and read in as Istream code in the same way that all other Alpha code is read. Once invoked, however, PALcode runs in a special mode called PALmode.

6.2 PALmode Environment

PALcode runs in a special environment called PALmode, defined as follows:

- Istream memory mapping is disabled. Because the PALcode is used to implement translation buffer fill routines, Istream mapping clearly cannot be enabled. Dstream mapping is still enabled.
- The program has privileged access to all of the computer hardware. Most of the functions handled by PALcode are privileged and need control of the lowest levels of the system.
- Interrupts are disabled. If a long sequence of instructions need to be executed atomically, interrupts cannot be allowed.

An important aspect of PALcode is that it uses normal Alpha instructions for most of its operations; that is, the same instruction set that nonprivileged Alpha programmers use. There are a few extra instructions that are only available in PALmode, and will cause a dispatch to the OPCDEC PALcode entry point if attempted while not in PALmode. The Alpha architecture allows some flexibility in what these special PALmode instructions do. In the 21264/EV68A, the special PALmode-only instructions perform the following functions:

- Read or write internal processor registers (HW_MFPR, HW_MTPR)
- Perform memory load or store operations without invoking the normal memory-management routines (HW_LD, HW_ST)
- Return from an exception or interrupt (HW_RET)

When executing in PALmode, there are certain restrictions for using the privileged instructions because PALmode gives the programmer complete access to many of the internal details of the 21264/EV68A. Refer to Section 6.4 for information on these special PALmode instructions.

Caution: It is possible to cause unintended side effects by writing what appears to be perfectly acceptable PALcode. As such, PALcode is not something that many users will want to change. Before writing PALcode, at least become familiar with the information in Appendix D.

6.3 Required PALcode Function Codes

Table 6–1 lists opcodes required for all Alpha implementations. The notation used is oo.ffff, where oo is the hexadecimal 6-bit opcode and ffff is the hexadecimal 26-bit function code.

Table 6–1 Required PALcode Function Codes

Mnemonic	Type	Function Code
DRAINA	Privileged	00.0002
HALT	Privileged	00.0000
IMB	Unprivileged	00.0086

6.4 Opcodes Reserved for PALcode

Table 6–2 lists the opcodes reserved by the Alpha architecture for implementation-specific use. These opcodes are privileged and are only available in PALmode.

Table 6–2 Opcodes Reserved for PALcode

Mnemonic	Opcode	Architecture Mnemonic	Function
HW_LD	1B	PAL1B	Dstream load instruction
HW_ST	1F	PAL1F	Dstream store instruction
HW_RET	1E	PAL1E	Return from PALcode routine
HW_MFPR	19	PAL19	Copies the value of an IPR into an integer GPR
HW_MTPR	1D	PAL1D	Writes the value of an integer GPR into an IPR

These instructions generally produce an OPCDEC exception if executed while the processor is not in PALmode. If I_CTL[HWE] is set, these instructions can also be executed in kernel mode. Software that uses these instructions must adhere to the PALcode restrictions listed in this section.

6.4.1 HW_LD Instruction

PALcode uses the HW_LD instruction to access memory outside the realm of normal Alpha memory management and to perform special Dstream load transactions. Data alignment traps are disabled for the HW_LD instruction.

Figure 6–1 shows the HW_LD instruction format.

Opcodes Reserved for PALcode

Figure 6–1 HW_LD Instruction Format

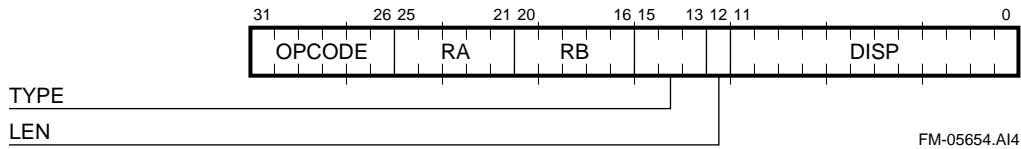

Table 6–3 describes the HW_LD instruction fields.

Table 6–3 HW_LD Instruction Fields Descriptions

Extent	Mnemonic	Value	Description
[31:26]	OPCODE	1B ₁₆	The opcode value.
[25:21]	RA	—	Destination register number.
[20:16]	RB	—	Base register for memory address.
[15:13]	TYPE	000 ₂	Physical — The effective address for the HW_LD instruction is physical.
		001 ₂	Physical/Lock — The effective address for the HW_LD instruction is physical. It is the load lock version of the HW_LD instruction.
		010 ₂	Virtual/VPTE — Flags a virtual PTE fetch (LD_VPTE). Used by trap logic to distinguish a single TB miss from a double TB miss. Kernel mode access checks are performed.
		100 ₂	Virtual — The effective address for the HW_LD instruction is virtual.
		101 ₂	Virtual/WrChk — The effective address for the HW_LD instruction is virtual. Access checks for fault-on-read (FOR), fault-on-write (FOW), read and write protection.
		110 ₂	Virtual/Alt — The effective address for the HW_LD instruction is virtual. Access checks use DTB_ALT_MODE IPR.
		111 ₂	Virtual/WrChk/Alt — The effective address for the HW_LD instruction is virtual. Access checks for FOR, FOW, read and write protection. Access checks use DTB_ALT_MODE IPR.
[12]		LEN	0
	1		Access length is quadword.
[11:0]	DISP	—	Holds a 12-bit signed byte displacement.

6.4.2 HW_ST Instruction

PALcode uses the HW_ST instruction to access memory outside the realm of normal Alpha memory management and to do special forms of Dstream store instructions. Data alignment traps are inhibited for HW_ST instructions. Figure 6–2 shows the HW_ST instruction format.

Figure 6–2 HW_ST Instruction Format

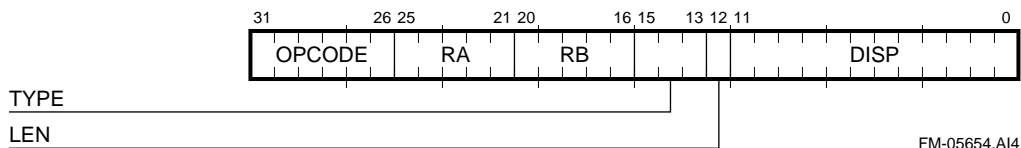

Table 6–4 describes the HW_ST instruction fields.

Table 6–4 HW_ST Instruction Fields Descriptions

Extent	Mnemonic	Value	Description
[31:26]	OPCODE	1F ₁₆	The opcode value.
[25:21]	RA	—	Write data register number.
[20:16]	RB	—	Base register for memory address.
[15:13]	TYPE	000 ₂	Physical — The effective address for the HW_ST instruction is physical.
		001 ₂	Physical/Cond — The effective address for the HW_ST instruction is physical. Store conditional version of the HW_ST instruction. The lock flag is returned in RA. Refer to PALcode restrictions for correct use of this function.
		010 ₂	Virtual — The effective address for the HW_ST instruction is virtual.
		110 ₂	Virtual/Alt — The effective address for the HW_ST instruction is virtual. Access checks use DTB_ALT_MODE IPR.
		All others	Unused.
[12]	LEN	0	Access length is longword.
		1	Access length is quadword.
[11:0]	DISP	—	Holds a 12-bit signed byte displacement.

6.4.3 HW_RET Instruction

The HW_RET instruction is used to return instruction flow to a specified PC. The RB field of the HW_RET instruction specifies an integer GPR, which holds the new value of the PC. Bit [0] of this register provides the new value of PALmode after the HW_RET instruction is executed. Bits [15:14] of the instruction determine the stack action.

Normally the HW_RET instruction succeeds a CALL_PAL instruction, or a trap handler that pushed its PC onto the prediction stack. In this mode, the HINT should be set to ‘10’ to pop the PC and generate a predicted target address for the HW_RET instruction.

In some conditions, the HW_RET instruction is used in the middle of a PALcode flow to cause a group of instructions to retire. In these cases, if the HW_RET instruction does not have a corresponding instruction that pushed a PC onto the stack, the HINT field should be set to ‘00’ to keep the stack from being modified.

In the rare circumstance that the HW_RET instruction might be used like a JSR or JSR_COROUTINE, the stack can be managed by setting the HINT bits accordingly.

See Section D.25 for more information about the HW_RET instruction.

Figure 6–3 shows the HW_RET instruction format.

Opcodes Reserved for PALcode

Figure 6–3 HW_RET Instruction Format

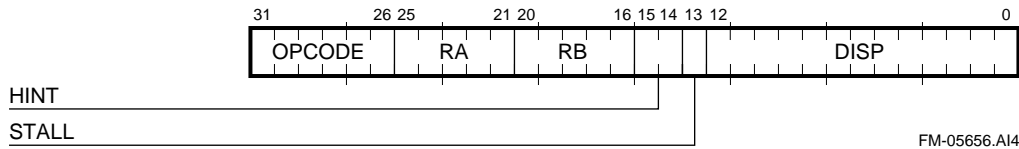

FM-05656.AI4

Table 6–5 describes the HW_RET instruction fields.

Table 6–5 HW_RET Instruction Fields Descriptions

Extent	Mnemonic	Value	Description
[31:26]	OPCODE	1E ₁₆	The opcode value.
[25:21]	RA	—	Register number. It should be R31.
[20:16]	RB	—	Target PC of the HW_RET instruction. Bit [0] of the register's contents determines the new value of PALmode.
[15:14]	HINT	00	HW_JMP — The PC is not pushed onto the prediction stack. The predicted target is PC + (4*DISP[12:0]).
		01	HW_JSR — The PC is pushed onto the prediction stack. The predicted target is PC + (4*DISP[12:0]).
		10	HW_RET — The prediction is popped off the stack and used as the target.
		11	HW_COROUTINE — The prediction is popped off the stack and used as the target. The PC is pushed onto the stack.
[13]	STALL	—	If set, the fetcher is stalled until the HW_RET instruction is retired or aborted. The 21264/EV68A will: <ul style="list-style-type: none"> • Force a mispredict • Kill instructions that were fetched beyond the HW_RET instruction • Refetch the target of the HW_RET instruction • Stall until the HW_RET instruction is retired or aborted <p>If instructions beyond the HW_RET have been issued out of order, they will be killed and refetched.</p>
[12:0]	DISP	—	Holds a 13-bit signed longword displacement.

6.4.4 HW_MFPR and HW_MTPR Instructions

The HW_MFPR and HW_MTPR instructions are used to access internal processor registers. The HW_MFPR instruction reads the value from the specified IPR into the integer register specified by the RA field of the instruction. The HW_MTPR instruction writes the value from the integer GPR, specified by the RB field of the instruction, into the specified IPR. Figure 6–4 shows the HW_MFPR and HW_MTPR instructions format.

Figure 6–4 HW_MFPR and HW_MTPR Instructions Format

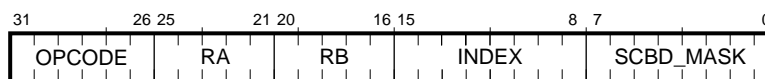

FM-05657.AI4

Table 6–6 describes the HW_MFPR and HW_MTPR instructions fields.

Table 6–6 HW_MFPR and HW_MTPR Instructions Fields Descriptions

Extent	Mnemonic	Value	Description
[31:26]	OPCODE	19 ₁₆	The opcode value for the HW_MFPR instruction.
		1D ₁₆	The opcode value for the HW_MTPR instruction.
[25:21]	RA	—	Destination register for the HW_MFPR instruction. It should be R31 for the HW_MTPR instruction.
[20:16]	RB	—	Source register for the HW_MTPR instruction. It should be R31 for the HW_MFPR instruction.
[15:8]	INDEX	—	IPR index.
[7:0]	SCBD_MASK	—	Specifies which IPR scoreboard bits in the IQ are to be applied to this instruction. If a mask bit is set, it indicates that the corresponding IPR scoreboard bit should be applied to this instruction.

6.5 Internal Processor Register Access Mechanisms

This section describes the hardware and software access mechanisms that are used for the 21264s IPRs.

Because the Ibox reorders and executes instructions speculatively, extra hardware is required to provide software with the correct view of the architecturally-defined state. The Alpha architecture defines two classes of state: general-purpose registers and memory. Register renaming is used to provide architecturally-correct register file behavior. The Ibox and Mbox each have dedicated hardware that provides correct memory behavior to the programmer. Because the internal processor registers are implementation-specific, and their state is not defined by the Alpha architecture, access mechanisms for these registers may be defined that impose restrictions and limitations on the software that uses them.

For every IPR, each instruction type can be classified by how it affects and is affected by the value held by that IPR.

- Explicit readers are HW_MFPR instructions that explicitly read the value of the IPR.
- Implicit readers are instructions whose behavior is affected by the value of the IPR. For example, each load instruction is an implicit reader of the DTB.
- Explicit writers are HW_MTPR instructions that explicitly write a value into the IPR.
- Implicit writers are instructions that may write a value into the IPR as a side effect of execution. For example, a load instruction that generates an access violation is an implicit writer of the VA, MM_STAT, and EXC_ADDR IPRs. In the 21264/EV68A, only instructions that generate an exception will act as implicit IPR writers.

Only certain IPRs, such as those with write-one-to-clear bits, are both implicitly and explicitly written. The read-write semantics of these IPRs is controlled by software.

6.5.1 IPR Scoreboard Bits

In previous Alpha implementations, IPR registers were not scoreboarded in hardware. Software was required to schedule HW_MTPR and HW_MFPR instructions for each machine's pipeline organization in order to ensure correct behavior. This software scheduling task is more difficult in the 21264/EV68A because the Ibox performs dynamic scheduling. Hence, eight extra scoreboard bits are used within the IQ to help maintain correct IPR access order. The HW_MTPR and HW_MFPR instruction formats contain an 8-bit field that is used as an IPR scoreboard bit mask to specify which of the eight IPR scoreboard bits are to be applied to the instruction.

If any of the unmasked scoreboard bits are set when an instruction is about to enter the IQ, then the instruction, and those behind it, are stalled outside the IQ until all the unmasked scoreboard bits are clear and the queue does not contain any implicit or explicit readers that were dependent on those bits when they entered the queue. When all the unmasked scoreboard bits are clear, and the queue does not contain any of those readers, the instruction enters the IQ and the unmasked scoreboard bits are set.

HW_MFPR instructions are stalled in the IQ until all their unmasked IPR scoreboard bits are clear.

When scoreboard bits [3:0] and [7:4] are set, their effect on other instructions is different, and they are cleared in a different manner.

If any of scoreboard bits [3:0] are set when a load or store instruction enters the IQ, that load or store instruction will not be issued from the IQ until those scoreboard bits are clear.

Scoreboard bits [3:0] are cleared when the HW_MTPR instructions that set them are issued (or are aborted). Bits [7:4] are cleared when the HW_MTPR instructions that set them are retired (or are aborted).

Bits [3:0] are used for the DTB_TAG and DTB_PTE register pairs within the DTB fill flows. These bits can be used to order writes to the DTB for load and store instructions. See Sections 5.3.1 and 6.9.1.

Bit [0] is used in both DTB and ITB fill flows to trigger, in hardware, a lightweight memory barrier (TB-MB) to be inserted between a LD_VPTE and the corresponding virtual-mode load instruction that missed in the TB.

6.5.2 Hardware Structure of Explicitly Written IPRs

IPRs that are written by software are physically implemented as two registers. When the HW_MTPR instruction that writes the IPR executes, it writes its value to the *first* register. When the HW_MTPR instruction is retired, the contents of the *first* register are written into the *second* register. Instructions that either implicitly or explicitly read the value of the IPR access the *second* register. Read-after-write and write-after-write dependencies are managed using the IPR scoreboard bits. To avoid write-after-read conflicts, the *second* register is not written until the writer is retired. The writer will not be retired until the previous reader is retired, and the reader is retired after it has read its value from the *second* register.

Some groups of IPRs are built using a single shared *first* register. To prevent write-after-write conflicts, IPRs that share a *first* register also share scoreboard bits.

6.5.3 Hardware Structure of Implicitly Written IPRs

Implicitly written IPRs are physically built using only a single level of register, however the IPR has two hardware states associated with it:

1. Default State—The contents of the register may be written when an instruction generates an exception. If an exception occurs, write a new value into the IPR and go to state 2.
2. Locked State—The contents of the register may only be overwritten by an excepting instruction that is older than the instruction associated with the contents of the IPR. If such an exception occurs, overwrite the value of the IPR. When the triggering instruction, or instruction that is older than the triggering instruction, is killed by the Ibox, go to state 1.

6.5.4 IPR Access Ordering

IPR access mechanisms must allow values to be passed through each IPR from a producer to its intended consumers.

Table 6–7 lists all of the paired instruction orderings between instructions of the four IPR access types. It specifies whether access order must be maintained, and if so, the mechanisms used to ensure correct ordering.

Table 6–7 Paired Instruction Fetch Order

Second Instruction	First Instruction			
	Implicit Reader	Implicit Writer	Explicit Reader	Explicit Writer
Implicit Reader	Read transactions can be reordered.	No IPRs in this class.	Read transactions can be reordered.	A variety of mechanisms are used to ensure order: scoreboard bits to stall issue of reader; HW_RET_STALL to stall reader; double write plus buffer blocks to force retire and allow for propagation delay.
Implicit Writer	No IPRs in this class.	The hardware structure of implicitly written IPRs handles this case.	IPR-specific PALcode restrictions are required for this case. An interlock mechanism must be placed between the explicit reader and the implicit writer (a read transaction).	No IPRs in this class.
Explicit Reader	Read transactions can be reordered.	If the reader is in the PALcode routine invoked by the exception associated with the writer, then ordering is guaranteed.	Read transactions can be reordered.	Scoreboard bits stall issue of reader until writer is retired.

Table 6–7 Paired Instruction Fetch Order (Continued)

Second Instruction	First Instruction			
Explicit Writer	Reader reads second register. Writer cannot write second register until it is retired.	Write-one-to-clear bits, or performance counter special case. For example, performance counter increments are typically not scoreboardd against read transactions.	Reader reads second register. Writer cannot write second register until it is retired.	Scoreboard bits stall second writer in map stage until first writer is retired.

For convenience of implementation, there is no IPR scoreboard bit checking within the same fetch block (octaword-aligned octaword).

- Within one fetch block, there can be only one explicit writer (HW_MTPR) to an IPR in a particular scoreboard group.
- Within one fetch block, an explicit writer (HW_MTPR) to an IPR in a particular scoreboard group cannot be followed by an explicit reader (HW_MFPR) to an IPR in that same scoreboard group.
- Within one fetch block, an explicit writer (HW_MTPR) to an IPR in a particular scoreboard group cannot be followed by an implicit reader to an IPR in that scoreboard group. This case covers writes to DTB_PTE or DTB_TAG followed by a LD, ST, or any memory operation, including HW_RETs without the ‘stall’ bit set.

6.5.5 Correct Ordering of Explicit Writers Followed by Implicit Readers

Across fetch blocks, the correct ordering of the explicit write of the DTB_PTE or DTB_TAG followed by an implicit reader (memory operation) is guaranteed using the IPR scoreboard bits.

However, there are cases where correct ordering of explicit writers followed by implicit readers cannot be guaranteed using the IPR scoreboard mechanism. If the instruction that implicitly reads the IPR does so before the issue stage of the pipeline, the scoreboard mechanism is not sufficient.

For example, modification of the ITB affects instructions before the issue state of the pipeline. In this case, PALcode must contain a HW_RET instruction, with its stall bit set, before any instruction that implicitly reads the IPR(s) in question. This prevents instructions that are newer than the HW_RET instruction from being successfully fetched, issued, and retired until after the HW_RET instruction is retired (or aborted).

There are also cases when the HW_RET with the STALL bit mechanism is not sufficient. There may be additional propagation delay past the retirement of the HW_RET instruction. In these cases, instead of using a HW_RET, a suggested method of ensuring the ordering is coding a group of 5 fetch blocks, where the first contains the HW_MTPR to the IPR, the second contains a HW_MTPR to the same IPR or one in the same scoreboard group, and where the following 3 fetch blocks each contain at least one non-NOP instruction. See Appendix D for a listing of cases where this method is recommended.

6.5.6 Correct Ordering of Explicit Readers Followed by Implicit Writers

Certain IPRs that are updated as a result of faulting memory operations require PALcode assistance to maintain ordering against newer instructions. Consider the following code sequence:

```
HW_MFPR IPR_MM_STAT
LDQ rx, (ry)
```

It is typically the case that these instructions would issue in-order:

- The MFPR is data-ready and both instructions use a lower subcluster. However, the HW_MFPRs (and HW_MTPRs) respond to certain resource-busy indications and do not issue when the MBOX informs the IBOX that a certain set of resources (store bubbles) are busy.
- The LDs respond to a different set of resource-busy indications (load-bubbles) and could issue around the HW_MFPR in the presence of the former. PALcode assistance is required to enforce the issue order.

One totally reliable method is to insert an MB (memory barrier) instruction before the first load that occurs after the HW_MFPR MM_STAT. Another method would be to force a register dependency between the HW_MFPR and the LD.

6.6 PALshadow Registers

The 21264/EV68A contains eight extra virtual integer registers, called shadow registers, which are available to PALcode for use as scratch space and storage for commonly used values. These registers are made available under the control of the SDE[1] field of the I_CTL IPR. These shadow registers overlay R4 through R7 and R20 through R23, when the CPU is in PALmode and SDE[1] is set.

PALcode generally runs with shadow mode enabled. Any PALcode that supports CALL_PAL instructions must run in that mode because the hardware writes a PALshadow register with the return address of CALL_PAL instructions.

PALcode may occasionally be required to toggle shadow mode to obtain access to the overlaid registers. See the PALcode restriction, Updating I_CTL[SDE], in Section D.32.

6.7 PALcode Emulation of the FPCR

The FPCR register contains status and control bits. They are accessed by way of the MT_FPCR and MF_FPCR instructions. The register is physically implemented like an explicitly written IPR. It may be written with a value from the floating-point register file by way of the MT_FPCR instruction. Architecturally-compliant FPCR behavior requires PALcode assistance. The FPCR register must operate as listed here:

1. Correct operation of the status bits, which must be set when a floating-point instruction encounters an exceptional condition, independent of whether a trap for the condition is enabled.
2. Correct values must be returned when the FPCR is read by way of a MF_FPCR instruction.

PALcode Entry Points

3. Correct actions must occur when the FPCR is written by way of a MT_FPCR instruction.

6.7.1 Status Flags

The FPCR status bits in the 21264/EV68A are set with PALcode assistance. Floating-point exceptions, for which the associated FPCR status bit is clear or for which the associated trap is enabled, result in a hardware trap to the ARITH PALcode routine. The EXC_SUM register contains information to allow this routine to update the FPCR appropriately, and to decide whether to report the exception to the operating system.

6.7.2 MF_FPCR

The MF_FPCR is issued from the floating-point queue and executed by the Fbox. No PALcode assistance is required.

6.7.3 MT_FPCR

The MT_FPCR instruction is issued from the floating-point queue. This instruction is implemented as an explicit IPR write operation. The value is written into the *first* latch, and when the instruction is retired, the value is written into the *second* latch. There is no IPR scoreboarding mechanism in the floating-point queue, so PALcode assistance is required to ensure that subsequent readers of the FPCR get the updated value.

After writing the *first* latch, the MT_FPCR instruction invokes a synchronous trap to the MT_FPCR PALcode entry point. The PALcode can return using a HW_RET instruction with its STALL bit set. This sequence ensures that the MT_FPCR instruction will be correctly ordered for subsequent readers of the FPCR.

6.8 PALcode Entry Points

PALcode is invoked at specific entry points, of which there are two classes: CALL_PAL and exceptions.

6.8.1 CALL_PAL Entry Points

CALL_PAL entry points are used whenever the Ibox encounters a CALL_PAL instruction in the Istream. To speed the processing of CALL_PAL instructions, CALL_PAL instructions do not invoke pipeline aborts but are processed as normal jumps to the offset from the contents of the PAL_BASE register, which is specified by the CALL_PAL instruction's function field.

The Ibox fetches a CALL_PAL instruction, bubbles one cycle, and then fetches the instructions at the CALL_PAL entry point. For convenience of implementation, returns from CALL_PAL are aided by a linkage register (much like JSRs). PALshadow register R23 is used as the linkage register. The Ibox loads the PC of the instruction after the CALL_PAL instruction, into the linkage register. Bit [0] of the linkage register is set if the CALL_PAL instruction was executed while the processor was in PALmode.

The Ibox pushes the value of the return PC onto the return prediction stack.

CALL_PAL instructions start at the following offsets:

- Privileged CALL_PAL instructions start at offset 2000_{16} .
- Nonprivileged CALL_PAL instructions start at offset 3000_{16} .

Each CALL_PAL instruction includes a function field that is used to calculate the PC of its associated PALcode entry point. The PALcode OPCDEC exception flow will be invoked if the CALL_PAL function field satisfies any of the following requirements:

- Is in the range of 40_{16} to $7F_{16}$ inclusive
- Is greater than BF_{16}
- Is between 00_{16} and $3F_{16}$ inclusive, and IER_CM[CM] is not equal to the kernel mode value 0

If none of the conditions above are met, the PALcode entry point PC is as follows:

- $PC[63:15] = PAL_BASE[63:15]$
- $PC[14] = 0$
- $PC[13] = 1$
- $PC[12] = CALL_PAL$ function field [7]
- $PC[11:6] = CALL_PAL$ function field [5:0]
- $PC[5:1] = 0$
- $PC[0] = 1$ (PALmode)

6.8.2 PALcode Exception Entry Points

When hardware encounters an exception, Ibox execution jumps to a PALcode entry point at a PC determined by the type of exception. The return PC of the instruction that triggered the exception is placed in the EXC_ADDR register and onto the return prediction stack.

Table 6–8 shows the PALcode exception entry locations and their offset from the PAL_BASE IPR.

Table 6–8 PALcode Exception Entry Locations

Entry Name	Type	Offset ₁₆	Description
DTBM_DOUBLE_3	Fault	100	Dstream TB miss on virtual page table entry fetch. Use three-level flow.
DTBM_DOUBLE_4	Fault	180	Dstream TB miss on virtual page table entry fetch. Use four-level flow.
FEN	Fault	200	Floating point disabled.
UNALIGN	Fault	280	Unaligned Dstream reference.
DTBM_SINGLE	Fault	300	Dstream TB miss.
DFAULT	Fault	380	Dstream fault or virtual address sign check error.
OPCDEC	Fault	400	Illegal opcode or function field: <ul style="list-style-type: none"> • Opcode 1, 2, 3, 4, 5, 6 or 7 • Opcode 19_{16}, $1B_{16}$, $1D_{16}$, $1E_{16}$ or $1F_{16}$, not PALmode or not I_CTL[HWE] • Extended precision IEEE format • Unimplemented function field of opcodes 14_{16} or $1C_{16}$
IACV	Fault	480	Istream access violation or virtual address sign check error.

Translation Buffer (TB) Fill Flows

Table 6–8 PALcode Exception Entry Locations (Continued)

Entry Name	Type	Offset ₁₆	Description
MCHK	Interrupt	500	Machine check.
ITB_MISS	Fault	580	Istream TB miss.
ARITH	Synch. Trap	600	Arithmetic exception or update to FPCR.
INTERRUPT	Interrupt	680	Interrupts: hardware, software, and AST.
MT_FPCR	Synch. Trap	700	Invoked when a MT_FPCR instruction is issued.
RESET/WAKEUP	Interrupt	780	Chip reset or wake-up from sleep mode.

6.9 Translation Buffer (TB) Fill Flows

This section shows the expected PALcode flows for DTB miss and ITB miss. Familiarity with 21264/EV68A IPRs is assumed.

6.9.1 DTB Fill

Figure 6–5 shows single-miss DTB instructions flow.

Figure 6–5 Single-Miss DTB Instructions Flow Example

```
hw_mfprp23, EV6__EXC_ADDR      ; (0L) get exception address
hw_mfprp4, EV6__VA_FORM        ; (4-7,1L) get vpte address
hw_mfprp5, EV6__MM_STAT        ; (0L) get miss info
hw_mfpr p7, EV6__EXC_SUM       ; (0L) get exc_sum for ra

hw_mfpr p6, EV6__VA            ; (4-7,1L) get original va
bic p7, #1, p7                 ; clear double miss flag
xor p4, p6, p4                 ; interlock p4 and p6
xor p4, p6, p4                 ; restore p4

trap_dtbm_single_vpte:
hw_ldq/v p4, (p4)              ; (1L) get vpte
bltp_misc, trap_dltol          ; (xU) <63>=1 => 1-to-1
blbcp4, trap__invalid_dppte    ; (xU) invalid => branch

andp4, #^x80, p7               ; isolate mb bit
xor p7, #^x80, p7              ; flip mb bit

ALIGN_FETCH_BLOCK <^x47FF041F>

PVC_VIOLATE <2>                ; ignore scoreboard violation
hw_mtprp6, EV6__DTB_TAG0       ; (2&6,0L) write tag0
hw_mtpr p6, EV6__DTB_TAG1      ; (1&5,1L) write tag1
hw_mtprp4, <EV6__DTB_PTE0 ! ^x44> ; (0,4,2,6) (0L) write pte0
hw_mtprp4, <EV6__DTB_PTE1 ! ^x22> ; (3,7,1,5) (1L) write pte1
```

```

ASSUME <tb_mb_en + pte_eco> ne 2
.if ne pte_eco
    bne p7, trap__dtbm_single_mb        ; branch for mb
    hw_ret (p23)                        ; return
trap__dtbm_single_mb:
    mb
    hw_ret(p23)                          ; return
.iff
    hw_ret(p23)                          ; return
                                        ; (assumes tb_mb_en on multi-processors)
.endc

```

The following list presents information about the single-miss DTB code example:

- In Figure 6–5, where (x,y) or (y) appear in the comments, *x* specifies the scoreboard bits and *y* specifies the Ebox subcluster.
- r4 –r7 and r20 – r23 are PALshadow registers.
- PALshadow r22 contains a flag that indicates whether the native code is running “1-to-1”, that is, running in a mode where the physical address should be mapped 1-to-1 to the virtual address, rather than being taken from a page table.
- IPR scoreboard bits [3:0] are used to order the restarted load or store instructions for the DTB write transactions.
- MM_STAT and VA will not be overwritten if the LD_VPTE instruction misses the DTB. There is no issue order constraint.
- The code is written to prevent a later execution of the DTB fill instruction from being issued before a previous execution and corrupting the previous write to the TB registers. The correct sequence of executions is accomplished by placing code dependencies on scoreboard bits [7:4] in the path of the successive writers. This prevents the successive writers from being issued before the previous writers are retired.
- When I_CTL[TB_MB_EN] = 1, the issue of MTPR DTB_PTE0 triggers, in hardware, a lightweight memory barrier (TB-MB). The lightweight memory barrier enforces read-ordering of store instructions from another processor (I) to this processor’s (J) page table and this processor’s virtual memory area such that if this processor sees the write to the PTE from (I) it will see the new data.

Processor I	Processor J
Wr Data	LD/ST
MB	<tb miss>
Wr PTE	LD-PTE, write TB LD/ST

Translation Buffer (TB) Fill Flows

- The conditional branch is placed in the code so that all of the MTPR instructions are issued and retired or none of them are issued and retired. This allows the TB fill hardware to update the TB whenever it sees the retiring of PTE1 and to ignore writes to TAG0/TAG1/PTE0/PTE1 in the interim between the issuing of those writes and a retire of PTE1.
- As an alternative to using `I_CTL[TB_MB_EN] = 1` to enforce read ordering, `I_CTL[TB_MB_EN]` can be set to 0 and the PALcode may use a bit in the PTE to indicate whether to do an explicit MB.

The flow example in Figure 6–5 shows the code using `pte_eco` and the code not using `pte_eco`. It assumes the following:

- In a multi-processor configuration, if `pte_eco` is not enabled, it is necessary to enable `tb_mb_en`.
- In a uni-processor configuration, if `pte_eco` is not enabled, it is not necessary to enable `tb_mb_en`.
- At no time should `pte_eco` and `tb_mb_en` both be enabled.
- The value in `DTB_PTEx[GH]` determines whether the scoreboard mechanism alone is sufficient to guarantee all subsequent load/store instructions (implicit readers of the DTB) are ordered relative to the creation of a new DTB entry; whether all subsequent loads and stores to the loaded address will hit in the DTB.
 - If `DTB_PTEx[GH]` is zero, the scoreboard mechanism alone is sufficient.
 - If `DTB_PTEx[GH]` is not zero, the scoreboard mechanism alone is not sufficient (although this is not a problem). In this case, the new DTB entry is not visible to subsequent load/store instructions until after the MTPR `DTB_PTE1` retires.

Issuing a `HW_RET_STALL` instead of a `HW_RET` would guarantee ordering, but is not necessary. Code executes correctly without the stall although execution might result in two passes through the DTB miss flow, rather than one, because the re-execution of the memory operation after the first DTB miss might miss again.

This behavior is functionally correct because DTB loads that tag-match an existing DTB entry are ignored by the 21264/EV68A and the second DTB miss execution will load exactly the same entry as the first.

6.9.2 ITB Fill

Figure 6–6 shows the ITB miss instructions flow.

Figure 6–6 ITB Miss Instructions Flow Example

```
hw_mfpr    r4,    EV6__IVA_FORM           ; (0L) get vpte address
hw_mfpr    r23,   EV6__EXC_ADDR          ; (0L) get exception address
lda        r6,    ^x0FFF(r31)            ; (xU) create mask for prot
bis        r31,  r31, r31                ; (xU) fill out fetch block
trap__itb_miss_vpte:
hw_ldq/v   r4,    (r4)                   ; (xL) get vpte
and        r4,  r6, r5                   ; (xL) get prot bits
bltp_misc, trap__iltol                  ; (xU) 1-to-1 => branch
```



```

srl      r4,    #OSF_PTE__PFN__S, r6           ; (xU) shift PFN to <0>
sll      r6,    #EV6__ITB_PTE__PFN__S, r6     ; (xU) shift PFN into place
and      r4,    #<1@OSF_PTE__FOE__S>, r7      ; (xL) get FOE bit
blbc     r4,    trap__invalid_ipte           ; (xU) invalid => branch
bne      r7,    trap__foe                    ; (xU) FOE => branch
srl      r4,    #7, r7                        ; check for mb bit
bis      r5,    r6, r6                        ; (xL) PTE in ITB format
hw_mtpr  r23,   EV6__ITB_TAG                 ; (6,0L) write tag
hw_mtpr  r6,    EV6__ITB_PTE                 ; (0&4,0L) write PTE

ASSUME <tb_mb_en + pte_eco> ne 2
.if ne pte_eco
    blbc     r7, trap__itb_miss_mb           ; branch for mb
    hw_ret_stall (r23); (0L)
trap__itb_miss_mb:
    mb
.endc
    hw_ret_stall (r23)                       ; (0L)

```

The following list presents information about the ITB miss flow code example:

- In Figure 6–6, where (x,y) or (y) appear in the comments, *x* specifies the scoreboard bits and *y* specifies the Ebox subcluster.
- The ITB is only accessed on Icache misses.
- r4 –r7 and r20 – r23 are PALshadow registers.
- PALshadow r22 contains a flag that indicates whether the native code is running “1-to-1”, that is, running in a mode where the physical address should be mapped 1-to-1 to the virtual address, rather than being taken from a page table.
- The HW_RET instruction should have its STALL bit set to ensure that the restarted Istream does not read the ITB until the ITB is written.

As an alternative to using I_CTL[TB_MB_EN] = 1 to enforce read ordering, I_CTL[TB_MB_EN] can be set to 0 and the PALcode may use a bit in the PTE to indicate whether to do an explicit MB. The flow example in Figure 6–6 assumes this alternative.

6.10 Performance Counter Support

The 21264/EV68A provides hardware support for two methods of obtaining program performance feedback information. The two methods do not require program modification. Instead, performance monitoring utilities make calls to the PALcode to set up the counters and contain interrupt handlers that call PALcode to retrieve the collected data. The first method, Aggregate mode, offers capabilities that are similar to earlier microprocessor performance counters. This mode counts events when enabled, until it overflows, causing an interrupt that can retrieve the collected data. The second method,

Performance Counter Support

ProfileMe mode, supports a new way of statistically sampling individual instructions during program execution. This mode counts events triggered by a targeted inflight instruction.

Counter support uses the hardware registers listed in Table 6–9.

Table 6–9 IPRs Used for Performance Counter Support

Register Name	Mnemonic	Relevant Fields	Described in Section
ProfileMe PC	PMP	All fields	5.2.6
Interrupt enable and current processor mode	IER_CM	PCEN[1:0]	5.2.9
Interrupt summary	ISUM	PC[1:0]	5.2.11
Ibox control	I_CTL	SPCE, PCT0_EN, PCT1_EN	5.2.15
Ibox status	I_STAT	OVR, ICM, TRAP-TYPE, LSO, TRP, MIS	5.2.16
Ibox process context	PCTX	PPCE	5.2.21
Performance counter support	PCTR_CTL	All fields	5.2.22

6.10.1 General Precautions

Initialize both counters, (PCTR_CTL[PCTR0 and PCTR1]), to zero in reset PALcode to avoid spurious interrupts when exiting initial PALcode. Counters must be written twice during initialization to ensure that the overflow latch has been cleared (see the PALcode restrictions in Sections D.28 and D.34).

The counters should never be left within one cycle of overflow when disabled because that can cause some interrupts to be blocked in anticipation of an overflow interrupt (see PALcode restriction 32).

If a counter is at the overflow threshold and a value is written to that counter, the counter signals an overflow interrupt upon leaving PALmode, even if that counter is disabled. To avoid that interrupt, the PALcode should clear the interrupt by writing to HW_INT_CLR.

Interrupts are disabled in PALmode.

As a quirk of the implementation, while counting is disabled, a read of PCTR_CTL can yield value+some increment, where value is the actual value in PCTR_CTL, and increment for PCTR0 is in the range 0..4 (retired instructions in that cycle), and increment for PCTR1 is dependent on SL1.

6.10.2 Aggregate Mode Programming Guidelines

Use the following information to program counters in Aggregate mode.

6.10.2.1 Aggregate Mode Precautions

Counters continue to count after overflow.

Only the counters return useful data. See Table 6–11 for counting modes.

Counters can be read by a PALcode instruction at any time to get the aggregate count.

The legal range for PCTR0 when writing the IPR is $0:(2^{20}-16)$.

The legal range for PCTR1 when writing the IPR is $0:(2^{20}-4)$.

6.10.2.2 Operation

1. Setup

The following IPRs need to be set up by PALcode instructions.

IPR Name	Relevant Fields	Meaning
IER_CM	PCEN[1:0]	Enable Interrupts.
PCTX	PPCE	Enable Process Performance Counting or use I_CTL[SPCE].
PCTR_CTL	SL0	Selects Aggregate or ProfileMe mode; set to 0 for Aggregate mode.
	SL1	Selects PCTR0 and PCTR1 counting modes. See Table 6–11 for more information.
	PCTR0[19:0]	Set counter 0 starting value $[0:(2^{20}-16)]$. See Section 6.10.1 for setup precautions.
	PCTR1[19:0]	Set counter 1 starting value $[0:(2^{20}-4)]$. See Section 6.10.1 for setup precautions.
I_CTL	SPCE	Enable System Performance Counting or use PCTX[PPCE].
	PCT0_EN	Enable performance counter 0.
	PCT1_EN	Enable performance counter 1.

2. Count

If PCTR0 and PCTR1 are enabled, will increment according to modes selected by SL0 and SL1.

3. Overflow

If PCEN[1:0] is enabled, PC[1:0] is set when PCTR0 or PCTR1 overflows.

4. Hardware interrupt

When PC[1:0] is set, the PALcode interrupt routine is entered. Interrupt is acknowledged and PALcode generates an interrupt to the operating system performance monitoring utility.

5. Operating system interrupt handler

The handler should read the IPR PCTR_CTL, as shown in Table 6–10, to note which counter overflowed in the handler's data structures. The handler may read the counter to see how many events have happened since the overflow.

The handler may also choose to write the counters to control the frequency of interrupts.

Table 6–10 Aggregate Mode Returned IPR Contents

IPR	Field	Contents
PCTR_CTL	PCTR0[19:0]	Counter #0 value
	PCTR1[19:0]	Counter #1 value

Performance Counter Support

6.10.2.3 Aggregate Counting Mode Description

6.10.2.3.1 Cycle counting

Counts cycles.

PCTR0 is incremented by the number of cycles counted, that is, 1.

6.10.2.3.2 Retired instructions cycles

PCTR0 is incremented by up to 8 retired instructions per cycle when enabled via I_CTL[PCT0_EN] and either I_CTL[SPCE] or PCTX[PPCE]. On overflow, an interrupt is triggered as ISUM[PC0] if enabled via IER_CM[PCEN0].

The 21264/EV68A can retire up to 11 instructions per cycle, which exceeds PCTR0's maximum increment of 8 per cycle. However, no retires go uncounted because the 21264/EV68A cannot sustain 11 retires per cycle, and the 21264/EV68A corrects PCTR0 in subsequent cycles.

A squashed instruction does not count as a retire.

6.10.2.3.3 Bcache miss or long latency probes cycles

This input counts the number of times the Bcache result was a miss.

Essentially, a long latency probe is a data request from other processes that cause Bcache misses in a system.

This count is phase shifted three cycles early and thus includes events that occurred three cycles before the start and before the end of the ProfileMe window.

6.10.2.3.4 Mbox replay traps cycles

This input counts Mbox replay traps.

6.10.2.4 Counter Modes for Aggregate Mode

Table 6–11 shows the counter modes that are used with Aggregate mode.

Table 6–11 Aggregate Mode Performance Counter IPR Input Select Fields

SL0[4]	SL1[3:2]	PCTR0	PCTR1
0	00	Retired instructions	Cycle counting
0	01	Cycle counting	Not defined
0	10	Retired instructions	Bcache miss or long latency probes
0	11	Cycle counting	Mbox replay traps

6.10.3 ProfileMe Mode Programming Guidelines

Use the following information to program counters in ProfileMe mode.

6.10.3.1 ProfileMe Mode Precautions

Squashed NOPs count as valid fetched instructions.

Counter 1 must be explicitly cleared in the trap handler before each data collection.

The CMOV instruction is decomposed into two valid fetched instructions that, in the absence of stalls, are fetched in consecutive cycles. See Table 6–12 for more information.

Table 6–12 CMOV Decomposed

Instruction	New Instructions
CMOV Ra, Rb--> Rc	CMOV1 Ra, oldRc --> newRc1 CMOV2 newRc1, Rb --> newRc2

6.10.3.2 Operation

1. Setup

The following IPRs need to be set up by using PALcode instructions.

IPR Name	Relevant Fields	Meaning
IER_CM	PCEN[1:0]	Enable Interrupts.
PCTX	PPCE	Enable Process Performance Counting or use I_CTL[SPCE].
PCTR_CTL	SL0	Selects Aggregate or ProfileMe mode; set to 1 for ProfileMe mode.
	SL1	Selects PCTR0 and PCTR1 counting modes. See Table 6–14 for more information.
	PCTR0[19:0]	Set counter 0 value (2^{20-N}). This selects approximately the Nth valid fetched instruction as the profiled instruction. Because writes to PCTR0 are incremented by 0.4, the profiled instruction is one of the (N-4)th to Nth valid fetched instructions. See Section 6.10.1 for more setup precautions.
	PCTR1[19:0]	Set counter 1 value = 0. See Section 6.10.1 for more setup precautions.
I_CTL	SPCE	Enable System Performance Counting or use PCTX[PPCE].
	PCT0_EN	Enable performance counter 0.
	PCT1_EN	Enable performance counter 1.

2. Open window

PCTR0 accumulates up to 4 valid fetched instructions per cycle when enabled via I_CTL[PCT0_EN] and either I_CTL[SPCE] or PCTX[PPCE].

The valid fetched instruction that causes PCTR0 to overflow opens the window and becomes the profiled instruction and covers a period of time near to when the instruction was in flight. The first cycle of the window is the 5th cycle after the instruction was fetched. A residual count of up to 7 valid fetched instructions is accumulated in PCTR0 in the two cycles between overflow and the start of the ProfileMe window. This residual count is returned in I_STAT[overcount(2,0)].

3. Count

If PCTR0 and PCTR1 are enabled, they increment according to modes selected by SL0 & SL1.

4. End window

The last cycle of the window depends on whether the instruction traps, retires, aborts, and/or is squashed by the fetcher.

Performance Counter Support

For instructions that cause a trap, the last cycle in the window is the 2nd cycle after the trap. Mispredicted branches are included in this category.

For nontrapping instructions that retire, the last cycle in the window is the 2nd cycle after the instruction retires.

For instructions that abort, the last cycle in the window is the 2nd cycle after the trap that caused the abort.

For instructions that are squashed (such as TRAPB), the last cycle in the window is approximately the 2nd cycle after the squashed instruction would have aborted or retired.

Every non-squashed valid fetched instruction either aborts or retires, but not both. In either case, the instruction may also trap.

PCTR0 is disabled from counting until PCTR_CTL is next written.

5. Interrupt PALcode

When ISUM field PC[1:0] is set, execution of PCTR0's or PCTR1's interrupt PALcode is performed.

6. Operating system interrupt handler

The handler should first read the IPRs in Table 6–13 and then write PCTR_CTL to set up the next interrupt.

Table 6–13 ProfileMe Mode Returned IPR Contents

IPR Name	Relevant Fields	Meaning
PMPC[63:0]	All	Profiled PC.
I_STAT	ICM	Instruction was in a new Icache fill stream.
	TRP	Instruction caused a trap and was not in the shadow of a younger trapping instruction.
	MIS	Conditional branch mispredict.
	TRAP TYPE	Exception type code.
	LSO	Load-store order replay trap.
	OVR	Counter 0 overcount.
PCTR_CTL	VAL	Instruction retired valid.
	TAK	Branch direction if instruction is a conditional branch.
	PM_STALLED	Instruction stalled for at least one cycle between fetch and map stages of pipeline.
	PM_KILLED_BM	Instruction killed during or before cycle in which it was mapped.
	PCTR0[19:0]	Counter 0 value.
PCTR1[19:0]	Counter 1 value.	

6.10.3.3 ProfileMe Counting Mode Description

6.10.3.3.1 Cycle counting

In ProfileMe mode, either counter counts cycles during the window of the profiled instruction.

6.10.3.3.2 Inum retire delay cycles

This input is used to measure a lower bound on the inum retire delay of the profiled instruction. The maximum final value of PCTR1 is the length of the ProfileMe window minus 2.

Counts cycles that a profiled instruction delayed the retire pointer advance during the ProfileMe window. The 21264/EV68A tracks instructions in the pipeline by allocating them "inums" near the front of the pipeline. All inums are retired in the order in which they were allocated at the end of the pipeline.

Inums are allocated in batches of four, so there may be more inums allocated than there are program instructions in flight. Every inum is retired in order, including those for aborted instructions.

The "retire pointer" points to the next inum to be retired. An inum retires in the cycle that the retire pointer advances past the inum.

Let X and Y be consecutive inums in the allocation order. The "inum retire delay" of Y is [(cycle in which Y retired) – (cycle in which X retired)]. A large inum retire delay indicates a possible performance bottleneck (for example, an instruction stalled on a data cache miss).

6.10.3.3.3 Retired instructions cycles

When counting retired instructions in ProfileMe mode, the final count in PCTR0 may include instructions that retired before the ProfileMe window and may exclude instructions that retired near the end of the ProfileMe window. These discrepancies are caused by a variable delay between the time that an instruction retires and the time that PCTR0 is incremented for that retire. This discrepancy is in the range of plus or minus 4 retired instructions.

6.10.3.3.4 Bcache miss or long latency probes cycles

This input counts the number of times the Bcache result was a miss.

Essentially, a long latency probe is a data request from other processes that cause Bcache misses in a system.

This count is phase shifted three cycles early and thus includes events that occurred three cycles before the start and before the end of the ProfileMe window.

6.10.3.3.5 Mbox replay traps cycles

This input counts Mbox replay traps.

PCTR1 is enabled to count Mbox replay traps that occur during a window that is the ProfileMe window phase-shifted one cycle later. The first replay trap counted would be the 7th cycle after the instruction is fetched.

Performance Counter Support

6.10.3.4 Counter Modes for ProfileMe Mode

Table 6–14 shows the counter modes that are used with ProfileMe mode.

Table 6–14 ProfileMe Mode PCTR_CTL Input Select Fields

SL0[4]	SL1[3:2]	PCTR0	PCTR1
1	00	Retired instructions	Cycle counting
1	01	Cycle counting	Inum retire delay
1	10	Retired instructions	Bcache miss or long latency probes
1	11	Cycle counting	Mbox replay traps

Initialization and Configuration

This chapter provides information on 21264/EV68A-specific microprocessor system initialization and configuration. It is organized as follows:

- Power-up reset flow
- Fault reset flow
- Energy star certification and sleep mode flow
- Warm reset flow
- Array initialization
- Initialization mode processing
- External interface initialization
- Internal processor register (IPR) reset state
- IEEE 1149.1 test port reset
- Reset state machine state transitions
- Phase-locked loop (PLL) functional description

Initialization is controlled by the reset state machine, which is responsible for four major operations. Table 7–1 describes the four major operations.

Table 7–1 21264/EV68A Reset State Machine Major Operations

Operation	Function
Ramp up	Sequence the PLL input and output dividers (X_{div} and Z_{div}) to gradually raise the internal GCLK frequency and generate time intervals for the PLL to re-establish lock.
BiST/SROM	Receive a synchronous transfer on the ClkFwdRst_H pin in order to start built-in self-test and SROM load at a predictable GCLK cycle.
Clock forward interface	Receive a synchronous transfer on the ClkFwdRst_H pin in order to initialize the clock forwarding interface.
Ramp down	Sequence the PLL input and output dividers (X_{div} and Z_{div}) to gradually lower the internal GCLK frequency during sleep mode.

7.1 Power-Up Reset Flow and the Reset_L and DCOK_H Pins

The 21264/EV68A reset sequence is triggered using the two input signals **Reset_L** and **DCOK_H** in a sequence that is described in Section 7.1.1. After **Reset_L** is deasserted, the following sequence of operations takes place:

Power-Up Reset Flow and the Reset_L and DCOK_H Pins

1. The clock forwarding and system clock ratio configuration information is loaded onto the 21264/EV68A. See Section 7.1.2.
2. The internal PLL is ramped up to operating frequency.
3. The internal arrays built-in self-test (BiST) is run, followed by Icache initialization using an external serial ROM (SROM) interface.

The 21264/EV68A systems, unlike the Alpha 21064 and 21164 microprocessor systems, are required to have an SROM. The SROM provides the only means to configure the system port, and the SROM pins can be used as a software-controlled UART.

The Icache must contain PALcode that starts at location 0x780. This code is used to configure the 21264/EV68A IPRs as necessary before causing any offchip read or write commands. This allows the 21264/EV68A to be configured to match the external system implementation.

4. After configuring the 21264/EV68A, control can be transferred to code anywhere in memory, including the noncacheable regions. The Icache can be flushed by a write operation to the ITB invalidate-all register after control is transferred. This transfer of control should be to addresses not loaded in the Icache by the SROM interface or the Icache may provide unexpected instructions.
5. Typically, any state required by the PALcode is initialized and then the console is started (switching out of PALmode and into native mode). The console code initializes and configures the system and boots an operating system from an I/O device such as a disk or the network.

Figure 7–1 shows the sequence of events at power-up, or cold reset. In Figure 7–1, note the following symbols for constraints and information:

Constraints:

- A Setup (A0) and hold (A1) for IRQ's to be latched by DCOK (2 ns for each).
- B Enough time for **Reset_L** to propagate through 5 stages of RESET synchronizer (clocked by the internal framing clock, which is driven by **EV6Clk_x**). Worst case for the 21264/EV68A would be $5 \times 8 \times 15 = 600$ GCLK cycles.
- C Min = 1 FrameClk cycle.

Information:

- a 8 GCLK cycles from DCOK assertion to first “real” **EV6Clk_x** cycle.
- b Approximately 525 GCLK cycles for external framing clock to be sampled and captured.
- c 1 **FrameClk_x** cycle.
- d 3 **FrameClk_x** cycles.
- e Approximately 264 GCLK cycles to prevent first command from appearing too early.
- f Approximately 700,000 GCLK cycles for BiST + approximately 100,000 GCLK cycles fixed time + approximately 50,000 GCLK cycles per line of Icache for SROM load.
- g 16 GCLK cycles.

Figure 7–1 Power-Up Timing Sequence

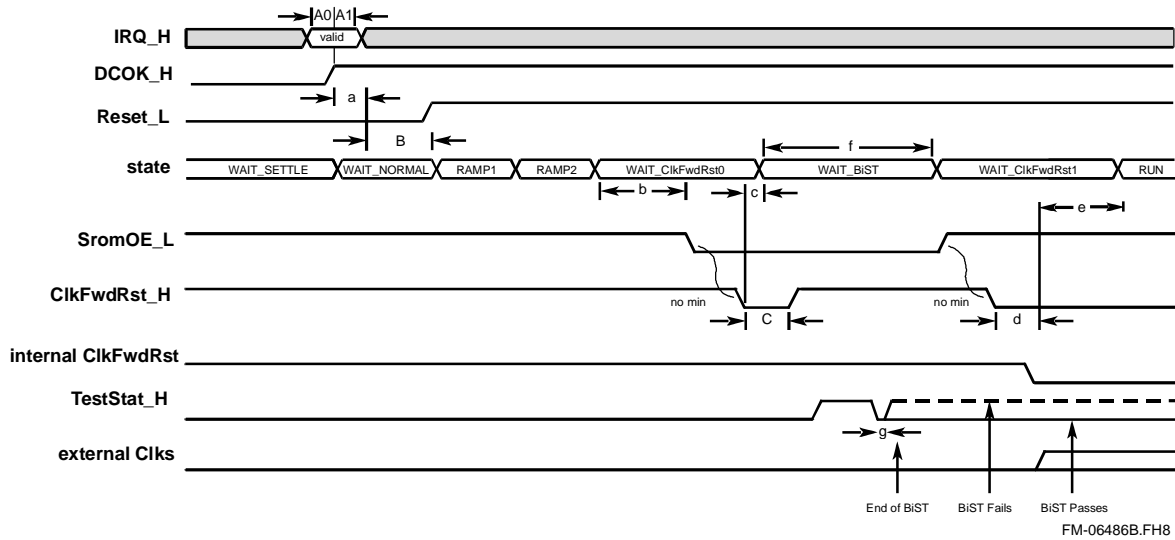

7.1.1 Power Sequencing and Reset State for Signal Pins

Power sequencing and avoiding potential failure mechanisms is described in Section 9.3.

The reset state for the signal pins is listed in Table 7–2.

Table 7–2 Signal Pin Reset State

Signal	Reset State	Signal	Reset State
Bcache			
BcAdd_H[23:4]	Tristated		
BcCheck_H[15:0]	Tristated	BcTagInClk_H	NA (input)
BcData_H[127:0]	Tristated	BcTagOE_L	Tristated
BcDataInClk_H[7:0]	NA (input)	BcTagOutClk_x	Tristated
BcDataOE_L	Tristated	BcTagParity_H	Tristated
BcDataOutClk_x[3:0]	Tristated	BcTagShared_H	Tristated
BcDataWr_L	Tristated	BcTagValid_H	Tristated
BcLoad_L	Tristated	BcTagWr_L	Tristated
BcTag_H[42:20]	Tristated	BcVref	NA (I_DC_REF)
BcTagDirty_H	Tristated		
System Interface			
IRQ_H[5:0]	NA (input)	SysDataInClk_H[7:0]	NA (input)
SysAddIn_L[14:0]	NA (input)	SysDataInvalid_L	NA (input)
SysAddInClk_L	NA (input)	SysDataOutClk_L[7:0]	Tristated

Table 7–2 Signal Pin Reset State (Continued)

Signal	Reset State	Signal	Reset State
SysAddOut_L[14:0]	Initially, during power-up reset, state is not defined. If not during power-up, preserves previous state. Then, after the clock forward reset period (as the external clocks start), signal driven to NZNOP until the reset state machine enters RUN, when it is driven to NOP.	SysDataOutValid_L	NA (input)
SysAddOutClk_L	Tristated	SysFillValid_L	NA (input)
SysCheck_L[7:0]	Tristated	SysVref	NA (I_DC_REF)
SysData_L[63:0]	Tristated		
Clocks			
ClkFwdRst_H	NA (input)	FrameClk_x	NA (input)
ClkIn_H ClkIn_L	NA (input)	PLL_VDD	NA (I_DC_REF)
EV6Clk_H EV6Clk_L	NA (input)		
Miscellaneous			
DCOK_H	Must be deasserted until dc voltage reaches proper operating level.	Tck_H	NA (input)
PIIBypass_H	NA (input)	Tdi_H	NA (input)
Reset_L	NA (input)	Tdo_H	Unspecified
SromClk_H	Tristated	TestStat_H	Tristated
SromData_H	NA (input)	Tms_H	NA (input)
SromOE_L	Tristated	Trst_L	NA (input)

In addition, as power is being ramped, **Reset_L** must be asserted — this allows the 21264/EV68A to reset internal state. Once the target voltage levels are attained, systems should assert **DCOK_H**. This indicates to the 21264/EV68A that internal logic functions can be evaluated correctly and that the power-up sequence should be continued. Prior to **DCOK_H** being asserted, the logic internal to the 21264/EV68A is being reset and the internal clock network is running (either clocked by the PLL VCO, which is at a nominal speed, or by **ClkIn_H**, if the PLL is bypassed).

The reset state machine is in state WAIT_SETTLE.

7.1.2 Clock Forwarding and System Clock Ratio Configuration

When **DCOK_H** is asserted, the 21264/EV68A samples several pins and latches in some initialization state, including the value of the PLL Y_{div} divisor, which specifies the ratio of the system clock to the internal clock (see Section 7.11.2.3), and enables the charge pump on the phase-locked loop.

Table 7–3 summarizes the pins and the suggested/required initialization state. Most of this information is supplied by placing (switch-selectable or hardwired) weak pull-ups or pull-downs on the **IRQ_H** pins. The **IRQ_H** pins are sampled on the rising edge of **DCOK_H**, during which time the 21264/EV68A is in reset and is not generating any system activity. During normal operation, the **IRQ_H** pins supply interrupt requests to the 21264/EV68A.

It is possible to disable the 21264/EV68A PLL and source GCLK directly from **ClkIn_x**. This mode is selected via **PllBypass_H**. The 21264/EV68A still produces a divided-down clock on **EV6Clk_x**; this output clock, which tracks GCLK, can be used in a feedback loop to generate a locked input clock via an external PLL. The input clock can be locked against a slower speed system reference clock.

Table 7–3 Pin Signal Names and Initialization State

Signal Name	Sample Time	Function	Value
PllBypass_H	Continuous input	Select ClkIn_x onto GCLK instead of internal PLL.	0 Bypass ¹ 1 Use PLL
ClkFwdRst_H	Sampling method according to IRQ_H[4]	—	—
Reset_L	Continuous input	—	—
IRQ_H[5]	Rising edge of DCOK_H	Select 1:1 FrameClk mode. Internal FrameClk can be generated two ways: 1 By sampling FrameClk_H . Used if FrameClk_H is slower than ClkIn_H . 2 As a direct copy of EV6Clk_H . Used if FrameClk_H is the same frequency as ClkIn_H or is DC.	0 Sample with FrameClk_H 1 Use a copy of EV6Clk_H
IRQ_H[4]	Rising edge of DCOK_H	Select method of sampling ClkFwdRst_H to produce internal ClkFwdRst — either with external or internal copy of FrameClk_x .	0 Sample with External FrameClk_x 1 Sample with Internal Frameclk
IRQ_H[3:0]	Rising edge of DCOK_H	Select Y_{div} divisor value. This is the divide-down factor between GCLK and EV6Clk_x . When the PLL is in use and the 21264/EV68A is ramped-up to full speed, the VCO adjusts in order to phase-align (and rate-match) EV6Clk_x to ClkIn_x . When the PLL is not in use, and ClkIn_x is bypassed onto GCLK, EV6Clk_x is slower than ClkIn_x by the divisor Y_{div} .	IRQ_H[3:0] Divisor 0011 3 0100 4 0101 5 0110 6 0111 7 0000 8 1000 9 1001 10 1010 11 1011 12 1100 13 1101 14 1110 15 1111 16

Table 7–3 Pin Signal Names and Initialization State (Continued)

Signal Name	Sample Time	Function	Value
DCOK_H	Continuous input	When deasserted, initializes the internal 21264/EV68A reset state machine and keeps the PLL internal oscillator running at a nominal speed. Assertion, which implies power to the 21264/EV68A is good, causes configuration information to be sampled.	—

¹ The maximum permissible instantaneous change in **ClkIn_x** frequency is 333 MHz (to prevent current spikes).

7.1.3 PLL Ramp Up

After the configuration is loaded through the **IRQ_H** pins, the next phase in the power up flow is the internal PLL ramp up sequence. Ramping up of the PLL is required to guarantee that the dynamic change in frequency will not cause the supply on the 21264/EV68A to fall due to the supply loop inductance. Clock control circuitry steps GCLK from power-up/reset clocking to 1/16th operating frequency, to ½ operating frequency, and finally normal operating frequency.

After the assertion of **DCOK_H**, the 21264/EV68A waits for the deassertion of **Reset_L** from the system while the PLL attempts to achieve a lock. The PLL internal ramp dividers are set to divide down the input clock by 16 and the PLL attempts to achieve lock against an effective input frequency of **ClkIn_x**/16. Once lock is achieved, the actual internal frequency (GCLK) is **ClkIn_x***(Y_{div} divisor value)/16. There should be a minimum delay of 100 ms between the assertion of **DCOK_H** and the deassertion of **Reset_L** to allow for this locking. The reset state machine is in the WAIT_NOMINAL state.

After the deassertion of **Reset_L**, the reset state machine goes into the RAMP1 state. The 21264/EV68A ramps the internal frequency, by changing the effective input frequency of the PLL to **ClkIn_x**/2 for a sufficient lock interval (at most, 20 µs at 400 MHz). The state machine then goes into the RAMP2 state, changing the effective input frequency to **ClkIn_x**/1 for an additional lock interval (about 20 µs). The lock periods are generated by the internal duration counter, which is driven by GCLK. The counter counts 4108 GCLK cycles during the **ClkIn_x**/2 lock interval. Note that GCLK is produced by the output of the PLL, which is locking to an input clock which is 1/2 of the operating frequency — therefore, the 4108 cycle interval constitutes a 6-20 µs interval when the operating frequency is 400–1250 MHz. Then, the counter counts 8205 GCLK cycles during the **ClkIn_x**/1 lock interval.

7.1.4 BiST and SRAM Load and the TestStat_H Pin

The 21264/EV68A uses the deassertion of **ClkFwdRst_H** (which must be deasserted for a minimum of one **FrameClk_H** cycle and then reasserted) to begin built-in self-test (BiST). The reset state machine goes into the WAIT_BiST state. Details on BiST are given in Chapter 11. The power-up BiST lasts approximately 700,000 cycles. The result of the self-test is made available on the **TestStat_H** pin. The pin is forced low by the system reset. It is then forced high during BiST.

As BiST completes, the **TestStat_H** pin is held low for 16 GCLK cycles. Then, if BiST succeeds, the pin remains low. Otherwise, it is asserted. After successfully completing BiST, the 21264/EV68A then performs the SROM load sequence (described in Chapter 11). After the SROM load sequence is finished, the 21264/EV68A deasserts **SromOE_L**.

7.1.5 Clock Forward Reset and System Interface Initialization

After the deassertion of **SromOE_L**, the reset state machine enters the WAIT_ClkFwdRst1 state, where the 21264/EV68A waits for the system to deassert **ClkFwdReset_H**. The 21264/EV68A samples the deasserting edge of **ClkFwdReset_H** to take synchronous actions. It uses this synchronous event to reset the clock forwarding interface, start the outgoing clocks, and deassert internal reset. The chip then waits 264 cycles before issuing commands. The reset state machine is then in RUN and the 21264/EV68A begins fetching code at address 0x780.

Table 7–4 lists signals relevant to the power-up flow, provides a short description of each, and any relevant constraints.

Table 7–4 Power-Up Flow Signals and Their Constraints

Signal Name	Description	Constraint
ClkIn_x	Differential clocks that are inputs to PLL or are bypassed onto GCLK directly	Clocks must be running before DCOK_H is asserted.
PLL_VDD	VDD supply to PLL	PLL_VDD must lead VDD .
VDD	VDD supply to the 21264/EV68A chip logic (except PLL)	—
DCOK_H	Logic signal to the 21264/EV68A that the VDD supply is good	—
Reset_L	RESET pin asserted by SYSTEM to the 21264/EV68A	Reset_L must be asserted prior to DCOK_H and must remain asserted for at least 100 ms after DCOK_H is asserted. This allows for PLL settling time. Deassertion of Reset_L causes the 21264/EV68A to ramp divisors to their final value and begin BiST.
ClkFwdRst_H Deassertion #1	Signal asserted by SYSTEM to synchronously commence built-in self-test and SROM load	ClkFwdRst_H must be deasserted after PLL has achieved its lock in its final divisor value (about 20 μs). The deassertion causes built-in self-test to begin on an internal clock cycle that corresponds to one framing clock cycle after ClkFwdRst_H is deasserted. ClkFwdRst_H can be asserted after one frame clock cycle. See Figure 7–1.
ClkFwdRst_H Deassertion #2	Signal asserted by SYSTEM to initialize and reset clock forwarding interfaces	ClkFwdRst_H must be deasserted when the Cbox has loaded configuration information. This occurs as the first part of the serial ROM load, after BiST is run. Once ClkFwdRst_H is deasserted, the interface is initialized and can receive probe requests from the 21264/EV68A.

7.2 Fault Reset Flow

The fault reset sequence of operation is triggered by the assertion of the **ClkFwdRst_H** signal line. Figure 7–2 shows the fault reset sequence of operation. The reset state machine is initially in RUN state. **ClkFwdRst_H** is asserted by the system, which causes the state machine to transition to the WAIT_FAULT_RESET state.

The 21264/EV68A internally resets a minimum amount of internal state. Note the effects of that reset on the IPRs in Table 7–5.

Table 7–5 Effect on IPRs After Fault Reset

IPR	After Reset
PAL_BASE	Maintained (not reset)
I_CTL	Bit value = 3 (both Icaches are enabled)
PCTX[FPE]	Set
WRITE_MANY	Cleared (That is, the WRITE_MANY chain is initialized and the Bcache is turned off.)
EXC_ADDR	Set to an address that is close to the PC

The 21264/EV68A then waits for **ClkFwdRst_H** to deassert twice:

- One deassert to transition directly to the WAIT_ClkFwdRst1 state without performing any BiST
- One deassert to initialize the clock forwarding interface

The 21264/EV68A then begins fetching code at PAL_BASE + 0x780.

Figure 7–2 shows the fault reset sequence of operation. In Figure 7–2, note the following symbols for constraints and information:

Constraints:

A Min = 1 **FrameClk_x** cycle

Information:

- a Approximately 264 GCLK cycles
- b Approximately 525 GCLK cycles for external framing clock to be sampled and captured
- c 1 **FrameClk_x** cycle plus 2 GCLK cycles
- e Next **FrameClk_x** rising edge
- f 3 **FrameClk_x** cycles
- g Approximately 264 GCLK cycles to prevent first command from appearing too early

Figure 7–2 Fault Reset Sequence of Operation

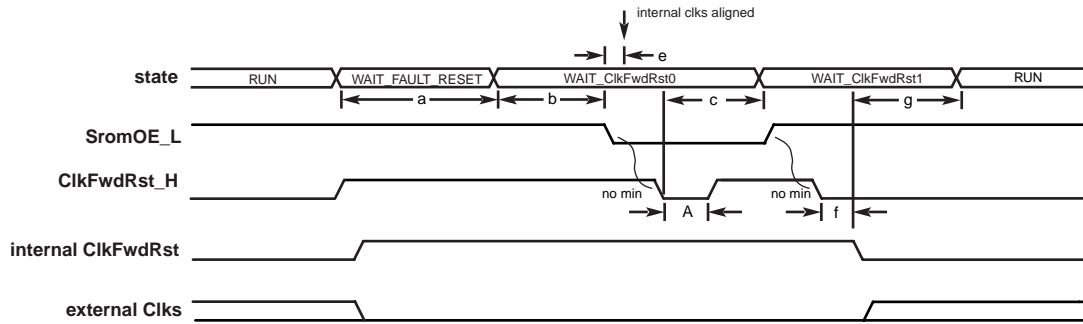

FM-06488B.A14

7.3 Energy Star Certification and Sleep Mode Flow

The 21264/EV68A is Energy Star compliant. Energy Star is a program administered by the Environmental Protection Agency to reduce energy consumption. For compliance, a computer must automatically enter a low power sleep mode using 30 watts or less after a specified period of inactivity. When the system is awakened, the user shall be returned automatically to the same situation that existed prior to entering sleep mode.

During normal operation, the 21264/EV68A encounters inactive periods and enters a mode that saves the entire active processor state to memory.

The PALcode is responsible for saving all necessary state to DRAM and flushing the caches.

The sleep mode sequence of operations is triggered by the PALcode twice performing a HW_MTPR to the Ibox SLEEP IPR. The first write prevents the assertion of **ClkFwdRst_H** from fault-resetting the chip.

The PALcode then informs the system, in an implementation-dependent way, that it may assert **ClkFwdRst_H**.

On the second HW_MTPR to the SLEEP IPR, the PLL begins to ramp down and the 21264/EV68A can then respond to the **ClkFwdRst_H** that was asserted by the system, causing the outgoing clocks from the 21264/EV68A to stop.

The PLL ramp-down sequence takes exactly the same amount of time as the ramp up sequence described in Section 7.1.3. The same internal duration counter is used and the reset state machine transitions through the DOWN1, DOWN2, and DOWN3 states which have similar PLL divisor ratios and clock speeds to the RAMP2, RAMP1, and WAIT_NOMINAL states.

After the PLL has finished ramping down, the reset state machine enters the WAIT_INTERRUPT state. Note the effects of the entry into that state on the IPRs listed in Table 7–6.

Table 7–6 Effect on IPRs After Transition Through Sleep Mode

IPR	Effects After Transition Through Sleep Mode
PAL_BASE	Maintained (not reset)
I_CTL	Bit value = 3 (both Icaches are enabled)
PCTX[FPE]	Set
WRITE_MANY	Cleared (That is, the WRITE_MANY chain is initialized and the Bcache is turned off.)

Note that Interrupt enables are maintained during sleep mode, enabling the 21264/EV68A to wake up. The 21264/EV68A waits for either an unmasked clock interrupt or an unmasked device interrupt from the system.

When an enabled interrupt occurs, the PLL ramps back to full frequency. Subsequent to that, the 21264/EV68A performs a built-in self-initialization (BiSI), a shortened built-in self-test, which initializes the internal arrayed structures. The SROM is not reloaded. Instead, the 21264/EV68A begins fetching code from the system at address PAL_BASE + 0x780.

Figure 7–3 shows the sleep mode sequence of operations. In Figure 7–3, note the following constraint and informational symbols:

Constraints:

A Min = 1 **FrameClk_x** cycle

Informational symbols:

- a Approximately 525 GCLK cycles for external framing clock to be sampled and captured
- b Next **FrameClk_x** rising edge
- c 1 **FrameClk_x** cycle
- d 3 **FrameClk_x** cycles
- e Approximately 264 GCLK cycles to prevent first command from appearing too early
- f Approximately 8192 GCLK cycles for BiSI
- g 16 GCLK cycles

Figure 7–3 Sleep Mode Sequence of Operation

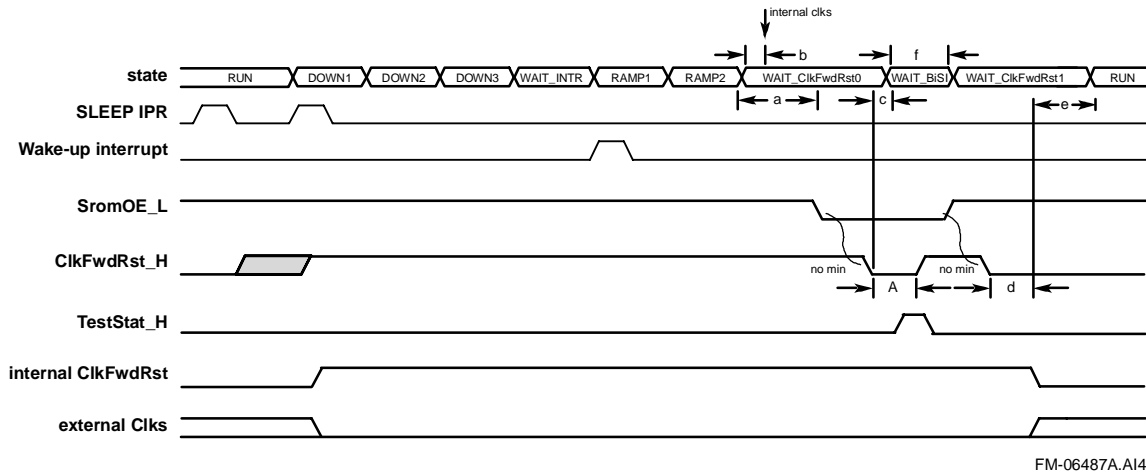

FM-06487A.A14

Table 7–7 describes each signal and constraint for the sleep mode sequence.

Table 7–7 Signals and Constraints for the Sleep Mode Sequence

Signal Name	Description	Constraint
ClkFwdRst_H	Signal asserted by the system to initialize and reset clock forwarding interfaces	ClkFwdRst_H must be asserted by the system when entering sleep mode. The system deasserts ClkFwdRst_H no sooner than one FrameClk_H cycle after sourcing an interrupt to the 21264/EV68A.
Forwarded clocks	Bit clocks forwarded to/from the 21264/EV68A	Clocks stop running under ClkFwdRst_H .
System interrupt	Asynchronous interrupt which causes the 21264/EV68A to exit sleep mode	—

7.4 Warm Reset Flow

The warm reset sequence of operation is triggered by the assertion of the **Reset_L** signal line. The reset state machine is initially in RUN state. The 21264/EV68A then, by default, ramps down the PLL (similar to the sleep flow sequence) and the reset state machine ends up in the WAIT_RESET state.

Note the effects of entry into that state on the IPRs listed in Table 7–8.

Table 7–8 Effect on IPRs After Warm Reset

IPR	Effects After Warm Reset
PAL_BASE	Cleared
L_CTL	Cleared
PCTX[FPE]	Set
WRITE_MANY	Cleared (That is, the WRITE_MANY chain is initialized and the Bcache is turned off.)

Array Initialization

The 21264/EV68A waits until **Reset_L** is deasserted before transitioning from the WAIT_RESET state. The 21264/EV68A ramps up the PLL until the state machine enters the WAIT_ClkFwdRst0 state. Note that the system must assert **ClkFwdRst_H** before the state machine enters the WAIT_ClkFwdRst0 state. Then, similarly to the other flows, **SromOE_L** is asserted and the system waits for the deassertion of **ClkFwdRst_H**.

On the deassertion of **ClkFwdRst_H**, the 21264/EV68A performs BiST and the SROM loading procedure.

After BiST and SROM loading have completed, **SromOE_L** deasserts and the 21264/EV68A waits for **ClkFwdRst_H** to deassert before starting the external clocks and, like the other flows, waits for 264 cycles before starting instructions.

7.5 Array Initialization

The following arrays are initialized by BiST:

- Icache and Icache tag
- Dcache, Dcache tag, and Duplicate Dcache tag
- Branch history table

The external second-level cache (Bcache) is disabled by **Reset_L**.

The Bcache must be initialized by PALcode before it is enabled.

7.6 Initialization Mode Processing

The initialization mode allows the 21264/EV68A to generate and manipulate cache blocks before the system interface has been initialized. Within the 21264/EV68A, the Cbox configuration registers are divided into the WRITE_ONCE and the WRITE_MANY shift register chains (see Sections 5.4.3 and 5.4.4). The WRITE_ONCE chain is loaded from the SROM during reset processing, and contains information such as the clock forwarding setup values. The WRITE_MANY chain can be written many times using MTPR instructions.

The WRITE_MANY chain contains the following CSRs that are important to initialization mode, which must be set to the values in Table 7–9 to initialize the Bcache.

Table 7–9 WRITE_MANY Chain CSR Values for Bcache Initialization

WRITE_MANY Chain CSRs	Required Value at Initialization Mode
BC_ENABLE	1 The duplicate bits for BC_ENABLE in [14:12] must be 0 during initialization mode.
BC_SIZE[3:0]	The exact size or maximum size of the Bcache.
INVAL_TO_DIRTY_ENABLE[1:0]	1
SET_DIRTY_ENABLE[2:0]	0
INIT_MODE	1

Table 7–9 WRITE_MANY Chain CSR Values for Bcache Initialization (Continued)

WRITE_MANY Chain CSRs	Required Value at Initialization Mode
EVICT_ENABLE	0
BC_WRT_STS[3:0]	0
BC_BANK_ENABLE	0

Except for INIT_MODE, all the CSR registers have been described in earlier sections. When asserted, INIT_MODE has the following behavior:

- Cache block updates to the Dcache set the block to the Clean state.
- Updates to the Bcache use the BC_WRT_STS[3:0] bits.
- WrVictimBlk command generation to the system interface are squashed.

Using the INVAL_TO_DIRTY_ENABLE and INIT_MODE registers, initialization code loaded from the SROM can generate and delete blocks inside the 21264/EV68A without system interaction. This behavior is very useful for initialization and startup processing, when the system interfaces are not fully functional. Figure 7–4 shows a code example for initializing Bcache.

Figure 7–4 Example for Initializing Bcache

```

Reset chip and load Icache with this code
set init_mode                ;now all WrVictims are ignored
                              ;bc_enable_a                1
                              ;zeroblk_enable_a           1
                              ;set_dirty_enable_a         0
                              ;init_mode_a                1
                              ;enable_evict_a             0
                              ;bc_wrt_sts_a               0
                              ;bc_bank_enable_a           0
                              ;bc_size_a                  15

                              ;now all writes to Bcache actually invalidate
                              ;the Bcache. (if space was needed for scratch
                              ;pad, the status bits could just as
                              ;well be Valid)

for 2 X bc_size              ;This loop generates legal ECC data, and
    { WH64 address }         ;invalidate tags which are written to the
                              ;Bcache for all but the final 64KB of address.

turn_off_bcache:            ;bc_enable_a                0
                              ;init_mode_a                0
                              ;bc_size_a                  0
                              ;zeroblk_enable_a           1
                              ;enable_evict_a             0
                              ;set_dirty_enable_a         0
                              ;bc_bank_enable_a           0
                              ;bc_wrt_sts_a               0

```

External Interface Initialization

```

SweepMemory:                ;Write good parity/ecc to memory by
                             ; writing a all memory locations. This is
                             ;done by WH64 of memory addresses

turn_on_bcache:             ;bc_enable_a           0
                             ;bc_size_a           Actual Bcache size
                             ;zeroblk_enable_a     3
                             ;set_dirty_enable_a    6
                             ;init_mode_a          0
                             ;enable_evict_a       0
                             ;bc_wrt_sts_a         0
                             ;bc_bank_enable_a     0

for 2 X bc_size              ;This loop generates legal ECC data, and
    { WH64 address }        ;invalidate tags which are written to the
                             ;Bcache for all but the final 64KB of address.

for 2 X dcache size         ;and cleans up the Dcache also.
    { ECB address }

(done)

```

In addition to initialization, the dynamic programming ability of the WRITE_MANY chain provides the basic tools to build various other software flows such as dynamically changing the Bcache enable/size parameters for performance testing.

7.7 External Interface Initialization

After reset, the system interface is in the default configuration dictated by the reset state of the IPR bits that select the configuration options.

The response to system interface commands and internally generated memory accesses is determined by this default configuration. System environments that are not compatible with the default configuration must use the SROM Icache load feature to initially load and execute a PALcode program to configure the external system interface unit IPRs as needed.

7.8 Internal Processor Register Power-Up Reset State

Many IPR bits are not initialized by reset. They are located in error-reporting registers and other IPR states. They must be initialized by initialization PALcode. Tables 7–5, 7–6, and 7–8, list the effects on IPRs by fault reset, transition through sleep mode, and warm reset, respectively. Table 7–10 lists the state of all internal processor registers (IPRs) immediately following power-up reset. The table also specifies which registers need to be initialized by power-up PALcode.

Table 7–10 Internal Processor Registers at Power-Up Reset State

Mnemonic	Register Name	Reset State	Comments
Ibox IPRs			
ITB_TAG	ITB tag array write	X	—
ITB_PTE	ITB PTE array write	X	—

Table 7–10 Internal Processor Registers at Power-Up Reset State (Continued)

Mnemonic	Register Name	Reset State	Comments
ITB_IAP	ITB invalidate-all (ASM=0)	X	—
ITB_IA	ITB invalidate all	X	Must be written to in PALcode.
ITB_IS	ITB invalidate single	X	—
PMPC	ProfileMePC	X	—
EXC_ADDR	Exception address	X	—
IWA_FORM	Instruction VA format	X	—
IER_CM	Interrupt enable current mode	X	Must be written to in PALcode.
SIRR	Software interrupt request	X	—
ISUM	Interrupt summary	X	—
HW_INT_CLR	Hardware interrupt clear	X	Must be cleared in PALcode.
EXC_SUM	Exception summary	X	—
PAL_BASE	PAL base address	Cleared	—
I_CTL	Ibox control	IC_EN = 3	All other bits are cleared on reset.
I_STAT	Ibox status	X	Must be cleared in PALcode.
IC_FLUSH	Icache flush	X	—
CLR_MAP	Clear virtual-to-physical map	X	—
SLEEP	Sleep mode	X	—
PCTX	Ibox process context	PCTX[FPE] is set. All other bits are X.	
PCTR_CTL	Performance counter control	X	Must be cleared in PALcode.
Ebox IPRs			
CC	Cycle counter	X	Must be cleared in PALcode.
CC_CTL	Cycle counter control	X	Must be cleared in PALcode.
VA	Virtual address	X	—
VA_FORM	Virtual address format	X	—
VA_CTL	Virtual address control	X	Must be cleared in PALcode.
Mbox IPRs			
DTB_TAG0	DTB tag array write 0	Cleared	—
DTB_TAG1	DTB tag array write 1	Cleared	—
DTB_PTE0	DTB PTE array write 0	Cleared	—
DTB_PTE1	DTB PTE array write 1	Cleared	—
DTB_ALTMODE	DTB alternate processor mode	X	PALcode must initialize.
DTB_IAP	DTB invalidate all process ASM = 0	X	—
DTB_IA	DTB invalidate all process	X	Must be written to in PALcode.

Table 7–10 Internal Processor Registers at Power-Up Reset State (Continued)

Mnemonic	Register Name	Reset State	Comments
DTB_IS0	DTB invalidate single (array 0)	X	—
DTB_IS1	DTB invalidate single (array 1)	X	—
DTB_ASN0	DTB address space number 0	Cleared	—
DTB_ASN1	DTB address space number 1	Cleared	—
MM_STAT	Memory management status	X	—
M_CTL	Mbox control	Cleared	—
DC_CTL	Dcache control	DC_CTL[7:2] are cleared at reset. DC_CTL[1:0] are set at power up.	
DC_STAT	Dcache status	X	Must be cleared in PALcode.
Cbox IPRs			
C_DATA	Cbox data	X	Must be read in PALcode.
C_SHFT	Cbox shift control	X	—

7.9 IEEE 1149.1 Test Port Reset

Signal **Trst_L** must be asserted when powering up the 21264/EV68A. **Trst_L** must not be deasserted prior to assertion of **DCOK_H**. **Trst_L** can remain asserted during normal operation of the 21264/EV68A.

7.10 Reset State Machine

The state diagram in Figure 7–5 summarizes how the 21264/EV68A transitions into running code. Each state is described in Table 7–11. Table 7–11 describes outputs and approximate state transition equations. Note that there are implicit transitions from each state to an appropriate down-ramp state when **Reset_L** is asserted.

Figure 7–5 21264/EV68A Reset State Machine State Diagram

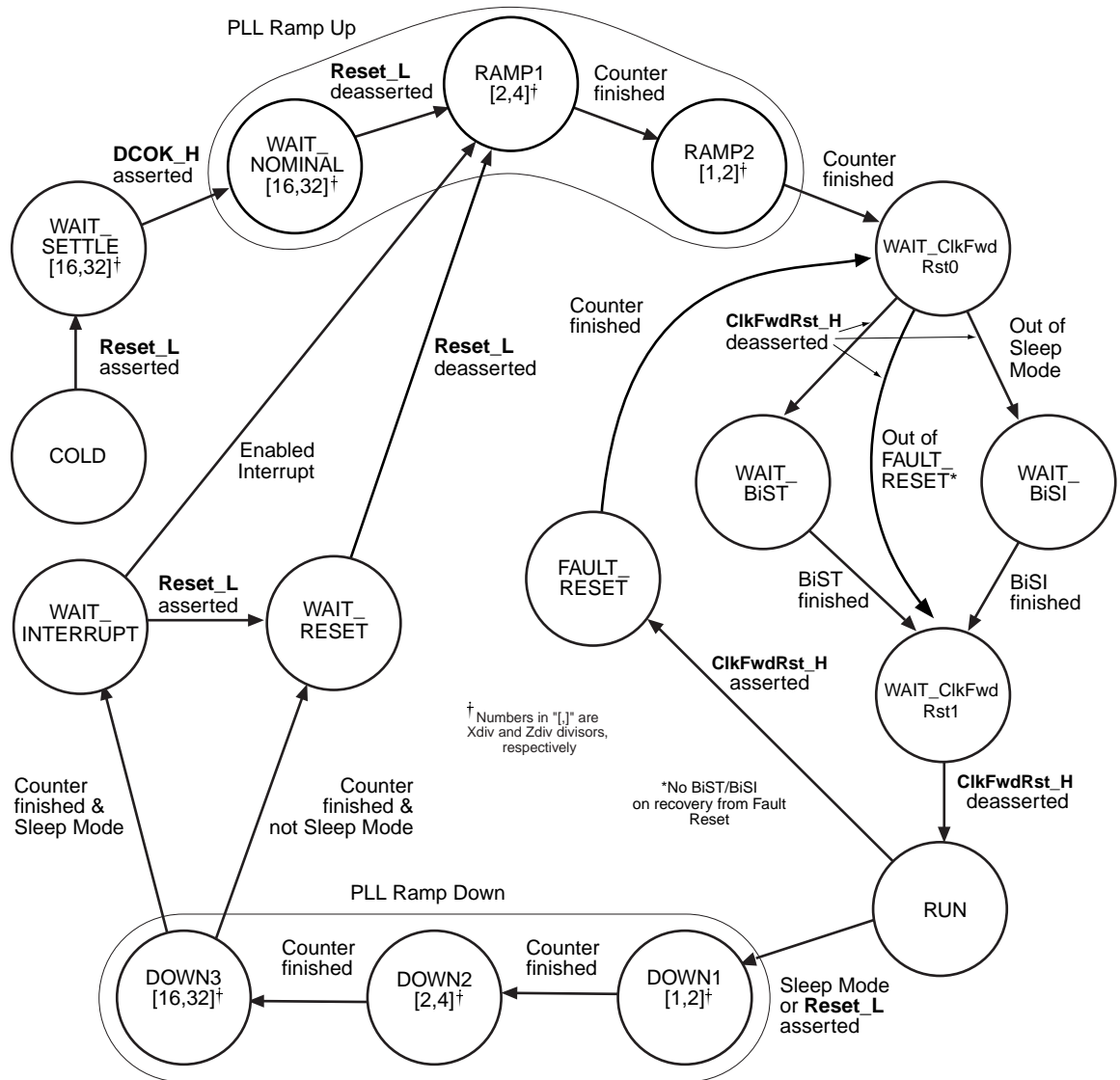

LKG-10982A-98WF

Table 7–11 21264/EV68A Reset State Machine State Descriptions

State Name	Description
COLD	Chip cold. Transitioned to WAIT_SETTLE with assertion of Reset_L , PLL_VDD , and VDD .
WAIT_SETTLE	PLL_VDD asserted; PLL at minimum frequency.
WAIT_NOMINAL	Triggered by assertion of DCOK_H . PLL achieves a lock at X _{div} and Z _{div} divisors equal 16 and 32, respectively.
RAMP1	Triggered by Reset_L deassertion; X _{div} and Z _{div} divisors are changed to 2 and 4, respectively, increasing the internal GCLK frequency. An internal duration counter is initialized to count 4108 GCLK cycles.

Reset State Machine

Table 7–11 21264/EV68A Reset State Machine State Descriptions (Continued)

State Name	Description
RAMP2	Triggered by the duration counter reaching 4108 cycles, the X_{div} and Z_{div} divisors are changed to 1 and 2, respectively, and the frequency is increased. The duration counter is reloaded to count 8205-cycles.
WAIT_ClkFwdRst0	Triggered by the duration counter reaching 8205 cycles (or by the deassertion of Reset_L while in the WAIT_RESET state). 21264/EV68A asserts SromOE_L and waits for SYSTEM to deassert ClkFwdReset_H . The deassertion must be synchronous to a falling edge of FrameClk_H . 21264/EV68A uses this deassertion to begin BiST and SROM load at a predictable time. 21264/EV68A samples and generates an internal, aligned copy of FrameClk_H , and, in turn, uses this clock to sample ClkFwdReset_H .
WAIT_BiST	BiST and SROM load is started. The SROM first loads the Write-once chain and then reads the number of bits of Icache data to load.
WAIT_BiSI	This state is entered when 'waking up' from sleep mode. 21264/EV68A receives an external interrupt, ramps the PLL, synchronously samples a transition on ClkFwdReset_H , and runs built-in self-initialization to clear the internal caches. Built-in self-test is not performed and the SROM is not loaded.
WAIT_ClkFwdRst1	Entered when the appropriate amount of BiST and SROM loading has been completed. 21264/EV68A deasserts SromOE_L and waits for SYSTEM to deassert ClkFwdReset_H . The deassertion must be synchronous to a rising edge of FrameClk_H . 21264/EV68A uses this synchronous event to reset the clock forwarding interface and deassert internal reset. 21264/EV68A subsequently begins running code (either preloaded in the SROM or located in memory) and begins system transactions.
RUN	Chip is running software, interface is reset, and system transactions can be processed. From power-up, the Icache sets are enabled and contain bootstrap code loaded from the SROM; 21264/EV68A executes code from Icache. From wake-up, the Icache sets are disabled and 21264/EV68A fetches and executes code from DRAM.
WAIT_RESET	Triggered by duration counter reaching 264 cycles, or when Reset_L is asserted when in WAIT_INTERRUPT state. 21264/EV68A waits in this state until Reset_L is deasserted, at which point, the PLL starts to ramp up again.
FAULT_RESET	ClkFwdReset is asserted while the 21264/EV68A is running. The 21264/EV68A internally resets a minimum amount of internal state, waits for clock forward reset deassertion, and begins fetching code at PAL_BASE + 0x780.
DOWN1	21264/EV68A was in a state in which GCLK was at its highest speed and Reset_L was asserted. Internal chip functions are reset and the internal duration counter is set to 8205 cycles. The purpose of this sequence is to down-ramp the clocks in anticipation of power being removed. If power is not removed (that is, reset is being toggled), 21264/EV68A ramps the clocks back to the original speed. This state is also entered when software writes the I_CTL internal processor register to sleep mode.

Table 7–11 21264/EV68A Reset State Machine State Descriptions (Continued)

State Name	Description
DOWN2	Triggered by duration counter reaching 8205 cycles, the PLL ramps GCLK frequency down by the first divider ratio (X_{div} and Z_{div} equal 2 and 4, respectively). This has the effect of halving the GCLK frequency. The duration counter is set to 4108 cycles.
DOWN3	Triggered by duration counter reaching 4108 cycles, the PLL ramps frequency down by the second divider ratio (X_{div} and Z_{div} equal 16 and 32, respectively). This has the effect of reducing the frequency by a factor of 16 (of the original frequency). The internal counter is set to 264 cycles.
WAIT_INTERRUPT	Triggered by duration counter reaching 264 cycles, the 21264/EV68A waits for either an unmasked clock interrupt or unmasked device interrupt from system. The interrupts are wired to the interrupt request and enable internal registers. When an enabled interrupt occurs, the PLL ramps back to full frequency. Subsequent to that, the built-in self-init (BiSI) initializes arrayed structures. The SROM is not reloaded; instead, the 21264/EV68A begins fetching code from the SYSTEM.

7.11 Phase-Lock Loop (PLL) Functional Description

The PLL multiplies the clock frequency of a differential input reference clock and aligns the phase of its output to that differential input clock. Thus, the 21264/EV68A can communicate synchronously on clock boundaries with clock periods that are defined by the system.

7.11.1 Differential Reference Clocks

A skew-controlled, ac-coupled differential clock is provided to the PLL by way of **ClkIn_x**. **ClkIn_x** are input signals to a differential amplifier. The frequency of **ClkIn_x** can range from 80 MHz to 200 MHz. **ClkIn_x** can be sourced by a variety of components that include PECL fanout parts or system PLLs. **ClkIn_x** are also the primary clock source for the 21264/EV68A when in PLL bypass mode.

7.11.2 PLL Output Clocks

The following sections summarize the PLL output clocks.

7.11.2.1 GCLK

The PLL provides an output clock, GCLK, with a frequency that can range from 400 MHz to 1.25 GHz under full-speed conditions. GCLK is the nominal onchip clock that is distributed to the entire 21264/EV68A chip.

7.11.2.2 Differential 21264/EV68A Clocks

The **EV6Clk_x** output pads provide an external test point to measure the PLL phase alignment. They do not provide a clock source. **EV6Clk_x** are square-wave signals that drive rail-to-rail continually from 0 to VDD.

7.11.2.3 Nominal Operating Frequency

Under normal operating conditions, the frequency of the PLL output clock, GCLK, is a simple function of the Y_{div} divider value.

Phase-Lock Loop (PLL) Functional Description

Table 7–12 shows the allowable **ClkIn_x** frequencies for a given operating frequency of the 21264/EV68A and the Y_{div} divider. For example, to set the 21264/EV68A GCLK frequency to 500 MHz with a **ClkIn_x** frequency of 166.7 MHz, the system must select a Y_{div} divider of 3 by placing the value 0011₂ on pins **IRQ_H[3:0]**.

Table 7–12 Differential Reference Clock Frequencies in Full-Speed Lock

GCLK		Reference Clock Frequency (MHz) for Y_{div} Dividers ¹													
Period (ns)	Frequency (MHz)	3 ²	4	5	6	7	8	9	10	11	12	13	14	15	16
2.5	400	133.3	100	80	—	—	—	—	—	—	—	—	—	—	—
2.4	416.7	138.9	104.2	83.3	—	—	—	—	—	—	—	—	—	—	—
2.3	434.8	144.9	108.7	87.0	—	—	—	—	—	—	—	—	—	—	—
2.2	454.5	151.2	113.6	90.9	—	—	—	—	—	—	—	—	—	—	—
2.1	476.2	158.7	119.0	95.2	—	—	—	—	—	—	—	—	—	—	—
2.0	500	166.7	125.0	100	83.3	—	—	—	—	—	—	—	—	—	—
1.9	526.3	175.4	131.6	105.3	87.7	—	—	—	—	—	—	—	—	—	—
1.8	555.6	185.2	138.9	111.1	92.6	—	—	—	—	—	—	—	—	—	—
1.7	588.2	196.1	147.1	117.6	98.0	84.0	—	—	—	—	—	—	—	—	—
1.6	625	—	156.3	125.0	104.2	89.3	—	—	—	—	—	—	—	—	—
1.5	666.7	—	166.7	133.3	111.1	95.2	83.3	—	—	—	—	—	—	—	—
1.4	714.3	—	178.6	142.9	119.1	102.0	89.3	—	—	—	—	—	—	—	—
1.3	769.2	—	192.3	153.8	128.2	109.9	96.2	85.5	—	—	—	—	—	—	—
1.2	833.3	—	—	166.7	138.9	119.0	104.2	92.6	83.3	—	—	—	—	—	—
1.1	909.1	—	—	181.8	151.5	129.9	113.6	101	90.9	—	—	—	—	—	—
1.0	1000	—	—	200	166.7	142.9	125	111.1	100	90.9	83.3	—	—	—	—
0.9	1111.1	—	—	—	185.2	158.7	138.9	123.5	111.1	101.0	92.6	85.5	—	—	—
0.8	1250	—	—	—	—	178.6	156.3	138.9	125	113.6	104.2	96.2	89.3	83.3	—

¹ Divider 16 is out of range for the 21264/EV68A and reserved for future use. Valid reference clock (**ClkIn_x**) frequencies for the 21264/EV68A are specified in the range from 80 to 200. Divider values that are out of that range are displayed as a dash “—”.

² Dividers of 1 and 2 are to be used only in a PLL test mode.

7.11.2.4 Power-Up/Reset Clocking

During the power-up/reset sequence, when not in PLL bypass mode, there may be a period of time when **ClkIn_x** is not yet running, but there is a voltage on **PLL_VDD**. The signal **DCOK_H** is deasserted until power is good throughout the system. The 10% to 90% rise time of **DCOK_H** should be less than 2 ns. The deasserted state of **DCOK_H** and the presence of **PLL_VDD** causes the PLL to generate a global clock that is distributed throughout the 21264/EV68A with a frequency range of 1 MHz to 500 MHz. The presence of the global clock during this period avoids permanent damage to the 21264/EV68A.

Error Detection and Error Handling

This chapter gives an overview of the 21264/EV68A error detection and error handling mechanisms, and is organized as follows:

- Data error correction code
- Icache data or tag parity error
- Dcache tag parity error
- Dcache data correctable ECC error
- Dcache store second error
- Dcache duplicate tag parity error
- Bcache tag parity error
- Bcache data correctable ECC error
- Memory/system port data correctable ECC error
- Bcache data correctable ECC error on a probe
- Double-bit fill errors
- Error case summary

Table 8–1 summarizes the 21264/EV68A error detection.

Table 8–1 21264/EV68A Error Detection Mechanisms

Component	Error Detection Mechanism
Bcache tag	Parity protected.
Bcache data array	Quadword-ECC protected.
Dcache tag array	Parity protected.
Dcache duplicate tag array	Parity protected.
Dcache data array	Quadword-ECC protected, however this mode of operation is only supported in systems that have ECC enabled on both the system and Bcache ports.
Icache tag array	Parity protected.
Icache data array	Parity protected.
System port data bus	Quadword-ECC protected.

8.1 Data Error Correction Code

The 21264/EV68A supports a quadword error correction code (ECC) for the system data bus. ECC is generated by the 21264/EV68A for all memory write transactions (WrVictimBlk) emitted from the 21264/EV68A and for all probe data. ECC is also checked on every memory read transaction for single-bit correction and double-bit error detection. Bcache data is checked for fills to the Dcache and Icache, and for Bcache-to-system transfers that are initiated by a probe (if enabled by the CSR ENABLE_PROBE_CHECK).

The 21264/EV68A ECC implementation corrects single-bit errors in hardware.

I/O write transaction data will not have a valid ECC (the ECC bits must be ignored by the system). Also, ECC checking is not performed on I/O read data.

Error detection and correction can be enabled/disabled by way of Mbox IPR DC_CTL[DCDAT_ERR_EN].

Table 8–2 shows the ECC code.

Table 8–2 64-Bit Data and Check Bit ECC Code

	11	1111	1111	2222	2222	2233	3333	3333	4444	4444	4455	5555	5555	6666	CCCC	CCCC		
	0123	4567	8901	2345	6789	0123	4567	8901	2345	6789	0123	4567	8901	2345	6789	0123	4567	
CB0	0111	0100	1101	0010	0111	0100	1101	0010	1000	1011	0010	1101	1000	1011	0010	1101	1000	0000
CB1	1110	1010	1010	1000	1110	1010	1010	1000	1110	1010	1010	1000	1110	1010	1010	1000	0100	0000
CB2	1001	1001	0110	0101	1001	1001	0110	0101	1001	1001	0110	0101	1001	1001	0110	0101	0010	0000
CB3	1100	0111	0001	1100	1100	0111	0001	1100	1100	0111	0001	1100	1100	0111	0001	1100	0001	0000
CB4	0011	1111	0000	0011	0011	1111	0000	0011	0011	1111	0000	0011	0011	1111	0000	0011	0000	1000
CB5	0000	0000	1111	1111	0000	0000	1111	1111	0000	0000	1111	1111	0000	0000	1111	1111	0000	0100
CB6	1111	1111	0000	0000	0000	0000	1111	1111	1111	1111	0000	0000	0000	0000	1111	1111	0000	0010
CB7	1111	1111	0000	0000	0000	0000	1111	1111	0000	0000	1111	1111	1111	1111	0000	0000	0000	0001

8.2 Icache Data or Tag Parity Error

The following actions are performed when an Icache data or tag parity error occurs.

1. When the hardware detects an error during an Icache read transaction, it traps and replays the instructions that were fetched during the error, then flushes the entire Icache so the re-fetched instructions do not come directly from the Icache.
2. I_STAT[PAR] is set.
3. A corrected read data (CRD) interrupt is posted, when enabled. (Pass 3 only)

8.3 Dcache Tag Parity Error

The primary copies of the Dcache tags are used only when servicing 21264/EV68A-generated load and store instructions. There are correctable and uncorrectable forms of this error. If an issued load or store instruction detects a Dcache tag parity error, the following actions are performed:

1. MM_STAT[DC_TAG_PERR] is set.
2. A Dstream fault (DFAULT) is taken.

3. The virtual address associated with the error is available in the VA register.
4. The PALcode flushes the error block by temporarily disabling DC_CTL[DCTAG_PAR_EN] and evicting the block using two HW_LD instructions. The onchip duplicate tag provides the correct victim address and cache coherence state.

If a retried load instruction detects the Dcache tag parity error, the memory reference may have already been retired, so the EXC_ADDR is not available. In this case, the error is uncorrectable and the Mbox performs the following actions:

- Either DC_STAT[TPERR_P0] or DC_STAT[TPERR_P1] is set, indicating the source of the error.
- When enabled, a machine check (MCHK) is posted. The MCHK is taken when not in PALmode.

8.4 Dcache Data Single-Bit Correctable ECC Error

The following operations may cause Dcache data ECC errors:

- Load instructions
- Stores of less than quadword length
- Dcache victim read transactions

The hardware flow used for Dcache data ECC errors depends on the event that caused the error.

8.4.1 Load Instruction

Loads that read data from the Dcache may do so either in the same cycle as the Dcache tag probe (typical case) or in some subsequent cycle (load-queue retry). The hardware functional flows for these two error cases differ slightly.

When a load instruction reads the Dcache data array in the same cycle as the tag array, if an ECC error occurs on the LSD ECC error detectors, then the Ibox stops retiring instructions and does not resume retiring until after hardware recovers from the error.

If an ECC error occurs on the LSD ECC error detectors, when a load instruction reads the Dcache tag array before it reads the Dcache data array, then the load instruction may have already been retired. In either case:

- The incorrect data is written into the load instruction's destination register; however, the load queue retains the state associated with the load instruction.
- A consumer of the load instruction's data may be issued before the error is recognized; however, the Ibox will invoke a replay trap at an instruction that is older than (or equal to) any instruction that consumes the load instruction's data, and then stalls the replayed Istream in the map stage of the pipeline until the error is corrected.
- Given a READ_ERR read-type from the Mbox for the error load instruction, the Cbox scrubs the block in the Dcache by evicting the block into the victim buffer (thereby scrubbing it) and writing it back into the Dcache as follows:
 - C_STAT[DSTREAM_DC_ERR] is set.

Dcache Store Second Error

- C_ADDR contains bits [19:6] of the Dcache address of the block that contains the error (bits [42:20] of the physical address are not updated).
- DC_STAT[ECC_ERR_LD] is set.
- The load queue retries the load and rewrites the register.
- A corrected read data (CRD) error interrupt is posted, when enabled.

Note: Errors in speculative load instructions cause a CRD error interrupt to be posted but the data is not scrubbed by hardware. The PALcode cannot perform a scrub because C_STAT is zero and C_ADDR does not contain the address of the error.

8.4.2 Store Instruction (Quadword or Smaller)

A store instruction that is a quadword or smaller could invoke a Dcache ECC error, since the original quadword must be read to calculate the new check bits.

- The Mbox scrubs the original quadword and replays the write transaction.
- DC_STAT[ECC_ERR_ST] is set.
- A corrected read data (CRD) error interrupt is posted, when enabled.

8.4.3 Dcache Victim Extracts

- Dcache victims with an ECC error are scrubbed as they are written into the victim data buffer.
- No status is logged.
- No exception is posted.

8.5 Dcache Store Second Error

A second store instruction error is logged when it occurs close behind the first. Neither error is corrected.

- DC_STAT[ECC_ERR_ST] is set.
- DC_STAT[SEO] is set.
- When enabled, a machine check (MCHK) is posted. The MCHK is taken when not in PALmode.

8.6 Dcache Duplicate Tag Parity Error

The Dcache duplicate tag has the *correct* version of the Dcache coherence state for the 21264/EV68A, allowing it to be used for correct tag/status data when the Dcache tags generate a parity error. These tags are parity protected also; however, the Dcache duplicate tag cell is designed to be much more tolerant of soft errors. The parity generators for the duplicate tags are enabled whenever the Cbox performs a physically-indexed read transaction of eight locations in the tag array. If an error is generated, the following actions are taken:

- Dcache duplicate tag parity errors are not recoverable.

- C_STAT[DC_PERR] is set.
- C_ADDR contains bits [42:6] of the Dcache duplicate tag address of the block that contains the error.
- When enabled, a machine check (MCHK) is posted. The MCHK is taken when not in PALmode.

8.7 Bcache Tag Parity Error

The Bcache tag parity is checked on all Bcache tag references, including references invoked by system probes. If an error is detected, the following actions are taken:

- Bcache tag parity errors are not recoverable.
- C_STAT[BC_PERR] is set.
- C_ADDR contains bits [42:6] of the Bcache address of the block that contains the error.
- When enabled, a machine check (MCHK) is posted. The MCHK is taken when not in PALmode.

8.8 Controlling Bcache Block Parity Calculation

Parity is calculated for either valid Bcache blocks or all Bcache blocks. The calculation is controlled by the value in Cbox CSR BC_VALID_MODE in the WRITE_MANY chain, as follows:

- If the MSB of BcTag_H is less than the value of Maximum PA in Table 4–13, then BC_VALID_MODE=1 and parity is calculated for only valid Bcache blocks.
- If the MSB of BcTag_H is greater than or equal to the value of Maximum PA in Table 4–13, then BC_VALID_MODE=0 and parity is calculated for all Bcache blocks.

For example, if BcTag_H[38:20] and Maximum PA is 36, then 38 is greater than or equal to 36 and BC_VALID_MODE=0 and parity is calculated for all Bcache blocks.

8.9 Bcache Data Single-Bit Correctable ECC Error

The following actions may trigger Bcache data ECC errors:

- Icache fill, data possibly used by Icache
- Dcache fill, data possibly used by load instruction
- Bcache victim during an ECB instruction or during a Dcache/Bcache miss

The recovery mechanism depends on the action that triggered the error.

8.9.1 Icache Fill from Bcache

For an Icache fill, the LSD ECC checkers detect the error, and bad Icache data parity is generated for the octaword that contains the quadword in error. If an error is detected, the following actions are taken:

- The hardware flushes the Icache.
- C_STAT[ISTREAM_BC_ERR] is set.

Bcache Data Single-Bit Correctable ECC Error

- C_ADDR contains bits [42:6] of the Bcache fill address of the block that contains the error.
- C_SYNDROME_0[7:0] and C_SYNDROME_1[7:0] contain the syndrome of quadword 0 and 1, respectively, of the octaword subblock that contains the error.
- A machine check (MCHK) is posted and taken immediately. The PALcode machine check handler performs a scrubbing operation as described in Section D.36 to ensure that the origination point of the error is corrected.

Note: A corrected read data (CRD) error interrupt is also posted in case this error is in a speculative path and the MCHK is removed. The CRD PALcode reads the status, to detect this condition, and scrubs the block. In the normal MCHK flow, the PALcode clears the pending CRD error.

8.9.2 Dcache Fill from Bcache

If the quadword in error is not used to satisfy a load instruction, a hardware recovery flow is not invoked. The quadword in error, and its associated check bits, are written into the Dcache. However, status is logged as shown in the bulleted list below, and a corrected read data (CRD) error interrupt is posted, when enabled. PALcode may elect to correct the error by scrubbing the block. If the error is not corrected by PALcode when it occurs, the error will be detected and corrected by a later load/victim operation.

If the quadword in error is used to satisfy a load instruction, then the flow is very similar to that used for a Dcache ECC error. The LSD ECC checker detects the error and the 21264/EV68A performs the following actions:

- The load instruction's destination register is written with incorrect data; however, the load queue will retain the state associated with the load instruction.
- A consumer of the load instruction's data may be issued before the error is recognized. The Ibox will invoke a replay trap at an instruction that is older than (or equal to) any instruction that consumes the load instruction's data. The 21264/EV68A then stalls the replayed Istream in the map stage of the pipeline, until the error is corrected.
- With a READ_ERR read type from the Mbox for the load instruction in error, the Cbox scrubs the block in the Dcache by evicting the block into the victim buffer and writing it back into the Dcache.
- C_STAT[DSTREAM_BC_ERR] is set.
- C_ADDR contains bits [42:6] of the Bcache fill address of the block that contains the error.
- C_SYNDROME_0[7:0] and C_SYNDROME_1[7:0] contain the syndrome of quadword 0 and 1, respectively, of the octaword subblock that contains the error.
- The load queue retries the load instruction and rewrites the register.
- DC_STAT[ECC_ERR_LD] is set.
- A corrected read data (CRD) error interrupt is posted, when enabled.

Memory/System Port Single-Bit Data Correctable ECC Error

Note: Errors in speculative load instructions cause a CRD error to be posted but the data is not scrubbed by hardware. The PALcode cannot perform a scrub operation because C_STAT is zero and C_ADDR does not contain the address of the block in error.

8.9.3 Bcache Victim Read

A victim from the Bcache is written directly to the system port, without correction. The ECC parity checker on the LSD detects the error and posts a corrected read data (CRD) error interrupt. The Cbox error register is not updated.

8.9.3.1 Bcache Victim Read During a Dcache/Bcache Miss

While the Bcache is servicing a Dcache miss and that Bcache access is also a miss, and an error occurs during that Bcache data access, the Cbox does not latch the error information. However, the Mbox correction state machine is activated and it invokes a CRD error despite the fact that no correction is performed.

The Bcache access error is written out to memory and is subsequently detected and corrected by the next consumer of the data.

- No correction is made.
- No status is logged (C_STAT = 0).
- A CRD error interrupt is posted, when enabled.

8.9.3.2 Bcache Victim Read During an ECB Instruction

A victim from the Bcache that occurs while an ECB instruction is being executed is written directly to the system port without correction. No Cbox registers are set and no exception is taken.

8.10 Memory/System Port Single-Bit Data Correctable ECC Error

The following actions may cause memory/system port data ECC errors:

- Icache fill—data possibly used by Icache
- Dcache fill—data possibly used by a load instruction

The recovery mechanism depends on the event that caused the error.

8.10.1 Icache Fill from Memory

For an Icache fill the LSD ECC generators detect the error, and bad Icache data parity is generated for the octaword that contains the quadword in error.

- The hardware flushes the Icache.
- C_STAT[ISTREAM_MEM_ERR] is set.
- C_ADDR contains bits [42:6] of the system memory fill address of the block that contains the error.
- C_SYNDROME_0[7:0] and C_SYNDROME_1[7:0] contain the syndrome of quadword 0 and 1, respectively, of the octaword subblock that contains the error.

Memory/System Port Single-Bit Data Correctable ECC Error

- A machine check (MCHK) is posted and taken immediately. The PALcode machine check handler performs a scrubbing operation as described in Section D.36 to ensure that the origination point of the error is corrected.

Note: Also, a corrected read data (CRD) error is posted, when enabled, in case this error is in a speculative path and the MCHK is removed. The CRD error PALcode reads the status to detect this condition and scrubs the block. In the normal MCHK flow, the PALcode clears the pending CRD error.

8.10.2 Dcache Fill from Memory

If the quadword in error is not used to satisfy a load instruction, no hardware recovery flow is invoked. The quadword in error, and its associated check bits, are written into the Dcache. However, status is logged as shown in the bulleted list below and a corrected read data (CRD) error interrupt is posted, when enabled. PALcode may choose to correct the error by scrubbing the block. If the error is not corrected by PALcode at the time, the error will be detected and corrected by a load/victim operation.

If the quadword in error is used to satisfy a load instruction, then the flow is very similar to that used for a Dcache ECC error:

- The load instruction's destination register is written with incorrect data; however, the load queue will retain the state associated with the load instruction.
- A consumer of the load instruction's data may be issued before the error is recognized; however, the Ibox will invoke a replay trap at an instruction that is older than (or equal to) any instruction that consumes the load instruction's data. The Ibox stalls the replayed Istream in the map stage of the pipeline until the error is corrected.
- With a READ_ERR read type from the Mbox for the load instruction in error, the Cbox scrubs the block in the Dcache by evicting the block into the victim buffer and writing it back into the Dcache.
- C_STAT[DSTREAM_MEM_ERR] is set.
- C_ADDR contains bits [42:6] of the system memory fill address of the block that contains the error.
- C_SYNDROME_0[7:0] and C_SYNDROME_1[7:0] contain the syndrome of quadword 0 and 1, respectively, of the octaword subblock that contains the error.
- The load queue retries the load instruction and rewrites the register.
- DC_STAT[ECC_ERR_LD] is set.
- A corrected read data (CRD) error interrupt is posted, when enabled.

Note: Errors in speculative load instructions cause a CRD error to be posted but the data is not scrubbed by hardware. The PALcode cannot scrub the data because C_STAT is zero, and C_ADDR does not have the address of the block with the error.

8.11 Bcache Data Single-Bit Correctable ECC Error on a Probe

The probed processor extracts the block from its Bcache, signaling a corrected read data (CRD) error and latching error information. The single-bit ECC detected error data is not corrected by the probed processor, but is forwarded to the requesting processor. The requesting processor then detects a related system fill error as a result of this system probe transaction.

- No hardware correction is performed.
- C_STAT[PROBE_BC_ERR] is set.
- C_ADDR contains bit [42:6] of the Bcache address of the block that contains the error.
- C_SYNDROME_0[7:0] and C_SYNDROME_1[7:0] contain the syndrome of quadword 0 and 1, respectively, of the octaword subblock that contains the error.
- A CRD error interrupt is posted, when enabled.
- The PALcode on the probed processor may choose to scrub the error, though it will probably be scrubbed by the requesting processor.

8.12 Double-Bit Fill Errors

Double-bit errors for fills are detected, but not corrected, in the 21264/EV68A. The following events may cause a double-bit fill error:

- Icache fill from Bcache
- Dcache fill from Bcache
- Icache fill from memory
- Dcache fill from memory

If an error is detected, the following actions are taken:

- C_STAT is set to one of the following:
 - ISTREAM_BC_DBL (Icache fill from Bcache)
 - DSTREAM_BC_DBL (Dcache fill from Bcache)
 - ISTREAM_MEM_DBL (Icache fill from memory)
 - DSTREAM_MEM_DBL (Dcache fill from memory)
- C_ADDR contains bits [42:6] of the system memory fill address of the block that contains the error.
- When enabled, a machine check (MCHK) is posted. The MCHK is taken when not in PALmode.
- A double-bit fill error from memory, marked by the data's corresponding ECC, when written to cache, also writes the corresponding ECC to cache. Any consumer of that error (such as another CPU) also consumes the corresponding ECC value.

Note: C_ADDR may be inaccurate in heavy traffic conditions. C_STAT is accurate.

8.13 Error Case Summary

Table 8–3 summarizes the various error cases and their ramifications.

Table 8–3 Error Case Summary

Error	Exception	Status	Hardware Action	PALcode Action
Icache data or tag parity error	CRD	ISTAT[PAR]	Icache flushed	Log as CRD
Dcache tag parity error (on issue)	DFAULT	MM_STAT[DC_TAG_PERR] VA[address]	—	Evict with two HW_LDs and log as CRD
Dcache tag parity error (on retry)	MCHK ¹	DC_STAT[TPERR_P0] or DC_STAT[TPERR_P1]	—	Log as MCHK
Dcache single-bit ECC error on load	CRD	DC_STAT[ECC_ERR_LD] C_STAT[DSTREAM_DC_ERR] C_ADDR[bits [19:6] of the error address. [42:20] not updated.]	Corrected and scrubbed	Log as CRD
Dcache single-bit ECC error on speculative load	CRD	DC_STAT[ECC_ERR_LD] C_STAT contains zero	None	Log as CRD
Dcache single-bit ECC error on small store	CRD	DC_STAT[ECC_ERR_ST]	Corrected and scrubbed	Log as CRD
Dcache single-bit ECC error on victim read	None	None	Corrected and scrubbed	None
Dcache second error on store	MCHK ¹	DC_STAT[SEO]	No correction on either store	Log as MCHK
Dcache duplicate tag parity error	MCHK ¹	C_STAT[DC_PERR] C_ADDR[error address]	Uncorrectable	Log as MCHK
Bcache tag parity error	MCHK ¹	C_STAT[BC_PERR] C_ADDR[error address]	Uncorrectable	Log as MCHK
Bcache single-bit error on Icache fill	MCHK and CRD ²	C_STAT[ISTREAM_BC_ERR] C_ADDR[error address] C_SYNDROME_0 C_SYNDROME_1	Icache flushed	Scrub error as described in Section D.36. Log as CRD
Bcache single-bit error on Dcache fill	CRD	DC_STAT[ECC_ERR_LD] C_STAT[DSTREAM_BC_ERR] C_ADDR[error address] C_SYNDROME_0 C_SYNDROME_1	Corrected and scrubbed in Dcache ³	Scrub error as described in Section D.36. Log as CRD
Bcache victim read on Dcache/Bcache miss	CRD	DC_STAT[ECC_ERR_LD] C_STAT contains 0	None	Log as CRD
Bcache victim read on ECB	None	None	None	None

Table 8–3 Error Case Summary (Continued)

Error	Exception	Status	Hardware Action	PALcode Action
Memory single-bit error on Icache fill	MCHK and CRD ²	C_STAT[ISTREAM_MEM_ERR] C_ADDR[error address] C_SYNDROME_0 C_SYNDROME_1	Icache flushed	Scrub error as described in Section D.36. Log as CRD
Memory single-bit error on Dcache fill	CRD	DC_STAT[ECC_ERR_LD] C_STAT[DSTREAM_MEM_ERR] C_ADDR[error address] C_SYNDROME_0 C_SYNDROME_1	Corrected and scrubbed in Dcache ³	Scrub error as described in Section D.36. Log as CRD
Bcache single-bit error on a probe hit	CRD	C_STAT[PROBE_BC_ERR] C_ADDR[error address] ⁴ C_SYNDROME_0 C_SYNDROME_1	None	May scrub error as described in Section D.36. Log as CRD
Bcache double-bit error on Icache fill	MCHK ¹	C_STAT[ISTREAM_BC_DBL] C_ADDR[error address] ⁴	None	Log as MCHK
Bcache double-bit error on Dcache fill	MCHK ¹	C_STAT[DSTREAM_BC_DBL] C_ADDR[error address] ⁴	None	Log as MCHK
Memory double-bit error on Icache fill	MCHK ¹	C_STAT[ISTREAM_MEM_DBL] C_ADDR[error address] ⁴	None	Log as MCHK
Memory double-bit error on Dcache fill	MCHK ¹	C_STAT[DSTREAM_MEM_DBL] C_ADDR[error address] ⁴	None	Log as MCHK

¹ Machine check taken in native mode. It is deferred while in PALmode.

² CRD error posted in case the machine check is down a speculative path.

³ For a single-bit error on a non-target quadword, the error is not corrected in hardware, but is corrected by PALcode during the scrub operation.

⁴ The contents of C_ADDR may not be accurate when there is heavy cache fill traffic.

This chapter describes the electrical characteristics of the 21264/EV68A and its interface pins. The chapter contains both ac and dc electrical characteristics and power supply considerations, and is organized as follows:

- Electrical characteristics
- DC characteristics
- Power supply sequencing
- AC characteristics

9.1 Electrical Characteristics

Table 9–1 lists the maximum electrical ratings for the 21264/EV68A.

Table 9–1 Maximum Electrical Ratings

Characteristics	Ratings	
Storage temperature	–55° C to +125° C (–67° F to 257° F)	
Junction temperature	0° C to 100° C (32° F to 212° F)	
Open-drain driver interface	2.0 V	
Push-pull driver interface	1.7 V	
Minimum dc voltage on signal pins	VSS – 400 mV	
Maximum power @ indicated VDD for the following frequencies:	Frequency	Peak Power
	750 MHz	60 W @ 1.7 V
	833 MHz	67 W @ 1.7 V
	875 MHz	70 W @ 1.7 V
	940 MHz	75 W @ 1.7 V

Notes: Stresses above those listed under the given maximum electrical ratings may cause permanent device failure. Functionality at or above these limits is not implied. Exposure to these limits for extended periods of time may affect device reliability.

Power data is preliminary and based on measurements from a limited set of material.

9.2 DC Characteristics

This section contains the dc characteristics for the 21264/EV68A. The 21264/EV68A pins can be divided into 10 distinct electrical signal types. The mapping between these signal types and the package pins is shown in Chapter 3. Table 9–2 shows the signal types.

Table 9–2 Signal Types

Signal Type	Description
I_DC_POWER	Supply voltage pins (VDD/PLL_VDD)
I_DC_REF	Input dc reference pin
I_DA	Input differential amplifier receiver
I_DA_CLK	Input differential amplifier clock receiver
O_OD	Open-drain output driver
O_OD_TP	Open-drain driver for test pins
O_PP	Push-pull output driver
O_PP_CLK	Push-pull output clock driver
B_DA_OD	Bidirectional differential amplifier receiver — open-drain
B_DA_PP	Bidirectional differential amplifier receiver — push-pull

Tables 9–3 through 9–12 show the dc switching characteristics of each signal type. Also, the following notes apply to Tables 9–3 through 9–12.

1. The differential voltage, V_{diff} , is the absolute difference between the differential input pins.
2. Delta V_{BIAS} is defined as the open-circuit differential voltage on the appropriate differential pairs. Test condition for these inputs are to let the input network self bias and measure the open circuit voltage. The test load must be $\geq 1M$ ohm. In normal operation, these inputs are coupled with a 680-pF capacitor.
3. Functional operation of the 21264/EV68A with less than all **VDD** and **VSS** pins connected is not implied.
4. The test load is a 50-ohm resistor to $VDD/2$. The resistor can be connected to the 21264/EV68A pin by a 50-ohm transmission line of any length.
5. DC test conditions set the minimum swing required. These dc limits set the trip point precision.
6. Input pin capacitance values include 2.0 pF added for package capacitance.

Note: Current out of a 21264/EV68A pin is represented by a – symbol while a + symbol indicates current flowing into a 21264/EV68A pin.

Table 9–3 VDD (I_DC_POWER)

Parameter Symbol	Description	Test Conditions	Minimum	Maximum
VDD	Processor core supply voltage	—	1.6 V	1.7 V
Power (sleep)	Processor power required (sleep)	@ VDD = 1.7 V Note 3	—	12 W ¹
PLL_VDD	PLL supply voltage	—	2.45 V	2.55 V
PLL_IDD	PLL supply current (running)	Freq = 940 MHz	—	25 mA

¹ Power measured at 37.5 MHz while running the “Ebox aliveness test.”

Table 9–4 Input DC Reference Pin (I_DC_REF)

Parameter Symbol	Description	Test Conditions	Minimum	Maximum
VREF	DC input reference voltage	—	600 mV	VDD – 100 mV
I _I	Input current	VSS ≤ V ≤ VDD	—	150 μA

Table 9–5 Input Differential Amplifier Receiver (I_DA)

Parameter Symbol	Description	Test Conditions	Minimum	Maximum
V _{IL}	Low-level input voltage	Note 5	—	VREF – 200 mV
V _{IH}	High-level input voltage	—	VREF + 200 mV	—
I _I	Input current	VSS ≤ V ≤ VDD	—	150 μA
C _{IN}	Input-pin capacitance	Freq = 10 MHz	—	5.7 pF Note 6

Table 9–6 Input Differential Amplifier Clock Receiver (I_DA_CLK)

Parameter Symbol	Description	Test Conditions	Minimum	Maximum
V _{diff}	Differential input voltage	—	200 mv Note 1	—
Δ V _{BIAS}	Open-circuit differential	I ≤ ± 1 μA Note 2	—	50 mV
I _I	Input current	VSS ≤ V ≤ VDD	—	150 μA
C _{IN}	Input-pin capacitance	Freq = 10 MHz	—	5.0 pF Note 6

DC Characteristics

Table 9–7 Pin Type: Open-Drain Output Driver (O_OD)

Parameter Symbol	Description	Test Conditions	Minimum	Maximum
V_{OL}	Low-level output voltage	$I_{OL} = 50 \text{ mA}$	—	400 mV
$ I_{OZ} $	High impedance output current	$0 < V < V_{DD}$	—	150 μA
C_{OD}	Open-drain pin capacitance	Freq = 10 MHz	—	5.7 pF Note 6

Table 9–8 Bidirectional, Differential Amplifier Receiver, Open-Drain Output Driver (B_DA_OD)

Parameter Symbol	Description	Test Conditions	Minimum	Maximum
V_{IL}	Low-level input voltage	Note 5	—	$V_{REF} - 200 \text{ mV}$
V_{IH}	High-level input voltage	—	$V_{REF} + 200 \text{ mV}$	—
V_{OL}	Low-level output voltage	$I_{OL} = 50 \text{ mA}$	—	400 mV
$ I_I $	Input current	$V_{SS} \leq V \leq V_{DD}$	—	150 μA ¹
C_{IN}	Input-pin capacitance	Freq = 10 MHz	—	5.7 pF Note 6

¹ Measurement taken with output driver disabled.

Table 9–9 Pin Type: Open-Drain Driver for Test Pins (O_OD_TP)

Parameter Symbol	Description	Test Conditions	Minimum	Maximum
V_{OL}	Low-level output voltage	$I_{OL} = 15 \text{ mA}$	—	400 mV
$ I_{OZ} $	High-impedance output current	$0 < V < V_{DD}$	—	150 μA
C_{OD_TP}	Pin capacitance	Freq = 10 MHz	—	5.2 pF Note 6

Table 9–10 Bidirectional, Differential Amplifier Receiver, Push-Pull Output Driver (B_DA_PP)

Parameter Symbol	Description	Test Conditions	Minimum	Maximum
V_{IL}	Low-level input voltage	—	—	$V_{REF} - 200 \text{ mV}$
V_{IH}	High-level input voltage	—	$V_{REF} + 200 \text{ mV}$	—
V_{OL}	Low-level output voltage	$I_{OL} = 6 \text{ mA}$	—	400 mV
V_{OH}	High-level output voltage	$I_{OH} = -6 \text{ mA}$	$V_{DD} - 400 \text{ mV}$	—
$ I_I $	Input current	$V_{SS} \leq V \leq V_{DD}$	—	150 μA ¹
C_{IN}	Input-pin capacitance	Freq = 10 MHz	—	6.0 pF Note 6

¹ Measurement taken with output driver disabled.

Table 9–11 Push-Pull Output Driver (O_PP)

Parameter Symbol	Description	Test Conditions	Minimum	Maximum
V _{OL}	Low-level output voltage	I _{OL} = 40 mA	—	500 mV
V _{OH}	High-level output voltage	I _{OL} = -40 mA	VDD - 500 mV	—
I _{OZ}	High-impedance output current	0 < V < VDD	—	150 μA
C _{OD}	Open-drain pin capacitance	Freq = 10 MHz	—	6.0 pF Note 6

Table 9–12 Push-Pull Output Clock Driver (O_PP_CLK)

Parameter Symbol	Description	Test Conditions	Minimum	Maximum
V _{OL}	Low-level output voltage	Note 4	—	VDD/2 - 325 mV
V _{OH}	High-level output voltage	Note 4	VDD/2 + 325 mV	—
I _{OZ}	High-impedance output current	0 < V < VDD	—	40 mA ¹

¹ Measured value includes current from onchip termination structures.

9.3 Power Supply Sequencing and Avoiding Potential Failure Mechanisms

Before the power-on sequencing can occur, systems should ensure that **DCOK_H** is deasserted and **Reset_L** is asserted. Then, systems ramp power to the 21264/EV68A **PLL_VDD @ 2.5 V** and the 21264/EV68A power planes (**VDD @ 1.65 V**, not to exceed 1.70 V under any circumstances), with **PLL_VDD** leading **VDD**. Systems should supply differential clocks to the 21264/EV68A on **ClkIn_H** and **ClkIn_L**. The clocks should be running as power is supplied.

When enabling the power supply inputs in a system, three failure mechanisms must be avoided:

1. Bidirectional signal buses must not conflict during power-up. A conflict on these buses can generate high current conditions, which can compromise the reliability of the associated chips.
2. Similarly, input receivers should not see intermediate voltage levels that can also generate high current conditions, which can compromise the reliability of the receiving chip.
3. Finally, no CMOS chip should see an input voltage that is higher than its internal VDD. In such a condition, a reasonable level of charge can be injected into the bulk of the die. This condition can expose the chip to a positive-feedback latchup condition.

The 21264/EV68A addresses those three failure mechanisms by disabling all of its outputs and bidirectional pins (with three exceptions) until the assertion of **DCOK_H**. The three exceptions are **Tdo_H**, **EV6Clk_L**, and **EV6Clk_H**. **Tdo_H** is used only in

the tester environment and does not need to be disabled. **EV6Clk_L** and **EV6Clk_H** are outputs that are both generated and consumed by the 21264/EV68A; thus, **VDD** tracks for both the producer and consumer.

On the push-pull interfaces:

- Disabling all output drivers leaves the output signal at the DC bias point of the termination network.
- Disabling the bidirectional drivers leaves the other consumers of the bus as the bus master.

On the open-drain interfaces:

- Disabling all output drivers leaves the output signal at the voltage of the open-drain pull-up.
- Disabling all bidirectional drivers leaves the other consumers of the bus as the bus master.

To avoid failure mechanism number two, systems must sequence and control external signal flow in such a way as to avoid zero differential into the 21264/EV68A input receivers (**I_DA**, **I_DA_CLK**, **B_DA_OD**, **B_DA_PP**, and **B_DA_PP**). Finally, to avoid failure mechanism number three, systems must sequence input and bidirectional pins (**I_DA**, **I_DA_CLK**, **B_DA_OD**, **B_DA_PP**, and **I_DC_REF**) such that the 21264/EV68A does not see a voltage above its **VDD**.

In addition, as power is being ramped, **Reset_L** must be asserted — this allows the 21264/EV68A to reset internal state. Once the target voltage levels are attained, systems should assert **DCOK_H**. This indicates to the 21264/EV68A that internal logic functions can be evaluated correctly and that the power-up sequence should be continued. Prior to **DCOK_H** being asserted, the logic internal to the 21264/EV68A is being reset and the internal clock network is running (either clocked by the VCO, which is at a nominal speed, or by **ClkIn_H**, if the PLL is bypassed).

The reset state machine is in state **WAIT_SETTLE**.

9.4 AC Characteristics

Abbreviations:

The following abbreviations apply to Table 9–13:

- TSU = Setup time
- Duty cycle = Minimum clock duty cycle
- TDH = Hold time
- Slew rate = referenced to signal edge

AC Test Conditions:

The following conditions apply to the measurements that are listed in Table 9–13:

- TSU, TDH, and TSkew values include the following onchip and package variations: min/max metal capacitance, GCLK skew, transistor gate length variation (OCV), across-chip temperature and voltage variation, and package lead-length variation.

- The AC specification values for TSU, TDH, and TSkew assume a ± 0.4 V input signal amplitude, relative to Vref, one volt per nanosecond slew rates, no mismatch in pin loading, and zero time-offset between forwarded clocks and data. Any deviation from those conditions can result in degraded chip performance.
 - VDD is in the range between 1.55 V and 1.65 V.
 - SysVref is 1.2 Volts.
 - BcVref is 0.75 Volts.
- All output skew data is based on simulation into a 50-ohm transmission line that is terminated with 50 ohms to VDD/2 for Bcache timing, and with 50 ohms to VDD for all other timing.

Timings are measured at the pins as follows:

- For open-drain outputs, timing is measured to $(V_{ol} + V_{term})/2$. Where V_{term} is the offchip termination voltage for system signals.
- For non-open-drain outputs, timing is measured to $(V_{ol} + V_{oh})/2$.
- For all inputs other than type I_DA_CLK, timing is measured to the point where the input signal crosses VREF.
- For type I_DA_CLK inputs, timing is measured when the voltage on the complementary inputs is equal.

Table 9–13 AC Specifications

Signal Name	Type	Reference Signal	TSU ¹	TDH ²	TSkew	Duty Cycle	TSlew
SysAddIn_L[14:0]	I_DA	SysAddInClk_L	400 ps	400 ps	NA	NA	1.0 V/ns
SysFillValid_L	I_DA	SysAddInClk_L	400 ps	400 ps	NA	NA	1.0 V/ns
SysDataInValid_L	I_DA	SysAddInClk_L	400 ps	400 ps	NA	NA	1.0 V/ns
SysDataOutValid_L	I_DA	SysAddInClk_L	400 ps	400 ps	NA	NA	1.0 V/ns
SysAddInClk_L	I_DA	NA	NA	NA	NA	45–55%	1.0 V/ns
SysAddOut_L[14:0]	O_OD	SysAddOutClk_L	NA	NA	± 300 ps ³	NA	NA
SysAddOutClk_L	O_OD	EV6Clk_x	NA	NA	± 350 ps	45-55%	NA
SysData_L[63:0]	B_DA_OD	SysDataInClk_H[7:0]	400 ps	400 ps	NA	NA	1.0 V/ns
		SysDataOutClk_L[7:0] ⁴	NA	NA	± 300 ps ³	NA	NA
SysCheck_L[7:0]	B_DA_OD	SysDataInClk_H[7:0]	400 ps	400 ps	NA	NA	1.0 V/ns
		SysDataOutClk_L[7:0] ⁴	NA	NA	± 300 ps ³	NA	NA
SysDataInClk_H[7:0]	I_DA	NA	NA	NA	NA	45-55%	1.0 V/ns
SysDataOutClk_L[7:0]	O_OD	EV6Clk_x	NA	NA	± 350 ps	45-55%	NA
BcAdd_H[23:4]	O_PP	BcTagOutClk_x	NA	NA	± 300 ps ^{5,6}	NA	—
BcDataOE_L	O_PP	BcDataOutClk_x[3:0] ⁷				45-55%	—
BcLoad_L	O_PP					38-63% ⁸	—
BcDataWr_L	O_PP					40-60% ⁹	—
BcData_H[127:0]	B_DA_PP	BcDataOutClk_x[3:0] ¹⁰	NA	NA	± 300 ps ⁶	45-55%	1.0 V/ns
						38-63% ⁸	NA
						40-60% ⁹	NA
		BcDataInClk_H[7:0]	400 ps	400 ps	NA	NA	NA

AC Characteristics

Table 9–13 AC Specifications (Continued)

Signal Name	Type	Reference Signal	TSU ¹	TDH ²	TSkew	Duty Cycle	TSlew	
BcDataInClk_H[7:0]	I_DA	NA	NA	NA	NA	45-55%		
BcDataOutClk_H[3:0]	O_PP	EV6Clk_x	NA	NA	± 350 ps			
BcDataOutClk_L[3:0]	O_PP	EV6Clk_x	NA	NA	± 350 ps			
BcTag_H[42:20]	B_DA_PP	BcTagInClk_H	400 ps	400 ps	NA	NA	1.0 V/ns	
BcTagDirty_H	B_DA_PP	BcTagInClk_H BcTagOutClk_x	400 ps	400 ps	NA	NA 38-63% ⁸	1.0 V/ns NA	
BcTagParity_H	B_DA_PP	BcTagInClk_H	400 ps	400 ps	NA	NA	1.0 V/ns	
BcTagShared_H	B_DA_PP	BcTagInClk_H BcTagOutClk_x	400 ps	400 ps	NA	NA 40-60% ⁹	1.0 V/ns NA	
BcTagValid_H	B_DA_PP	BcTagInClk_H BcTagOutClk_x	400 ps NA	400 ps NA	NA ± 300 ps ⁶	NA 45-55%	1.0 V/ns NA	
BcTagOE_L	O_PP							
BcTagWr_L	O_PP							
BcTagInClk_H	I_DA	NA	NA	NA	NA	45-55%		
BcTagOutClk_x	O_PP	EV6Clk_x	NA	NA	± 350 ps			
IRQ_H[5:0]	I_DA	DCOK_H	10 ns ¹¹	10 ns ¹¹	NA	NA	100 mV/ns	
Reset_L ¹²	I_DA		NA	NA	NA	NA	100 mV/ns	
DCOK_H ¹³	I_DA		NA	NA	NA	NA	100 mV/ns	
PllBypass_H ¹⁴	I_DA		NA	NA	NA	NA	100 mV/ns	
ClkIn_x ¹⁵	I_DA_CLK		NA	NA	NA	40–60% ¹⁶	1.0 V/ns	
FrameClk_x ¹⁷	I_DA_CLK	ClkIn_x	400 ps	400 ps	NA	NA	1.0 V/ns	
EV6Clk_x ¹⁸	O_PP_CLK	ClkIn_x	NA	NA	±1.0 ns	YDiv±5%	NA	
EV6Clk_x ¹⁹			Cycle Compression Specification: See Note 19					
ClkFwdRst_H	I_DA	FrameClk_x	400 ps	400 ps	NA	NA	1.0 V/ns	
SromData_H	I_DA	SromClk_H	2.0 ns	2.0 ns	NA		100 mV/ns	
SromOE_L	O_OD	EV6Clk_x	NA	NA	± 2.0 ns			
SromClk_H ²⁰	O_OD	EV6Clk_x	NA	NA	± 7.0 ns			
Tms_H	I_DA	Tck_H	2.0 ns	2.0 ns	NA	NA	100 mV/ns	
Trst_L ²¹	I_DA	Tck_H	NA	NA	NA	NA	100 mV/ns	
Tdi_H	I_DA	Tck_H	2.0 ns	2.0 ns	NA	NA	100 mV/ns	
Tdo_H	O_OD	Tck_H	NA	NA	± 7.0 ns	NA	NA	
Tck_H	I_DA	IEEE 1149.1 Port Freq. = 5.0 MHz Max.	NA	NA	NA	45-55%	100 mV/ns	
TestStat_H	O_OD	EV6Clk_x	NA	NA	± 4.0 ns	NA	NA	

¹ The TSU specified for all clock-forwarded signal groups is with respect to the associated clock.

- 2 The TDH specified for all clock-forwarded signal groups is with respect to the associated clock.
- 3 The TSkew value applies only when the SYS_CLK_DELAY[0:1] entry in the Cbox WRITE_ONCE chain (Table 5–24) is set to zero phases of delay between forwarded clock out and address/data.
- 4 The TSkew specified for **SysData_L** signals is only with respect to the associated clock.
- 5 These signals should be referenced to **BcTagOutClk_x** when measuring TSkew, provided that **BcTagOutClk_x** and **BcDataOutClk_x** have no programmed offset.
- 6 The TSkew value applies only when the BC_CLK_DELAY[0:1] entry in the Cbox WRITE_ONCE chain (Table 5–24) is set to zero phases of delay for Bcache clock.
- 7 The TSkew specified for **BcAdd_H** signals is only with respect to the associated clock.
- 8 The duty cycle for 2.5X single data mode 2 GCLK phases high and 3 GCLK phases low.
- 9 The duty cycle for 3.5X single data mode 3 GCLK phases high and 4 GCLK phases low.
- 10 The TSkew specified for **BcData_H** signals is only with respect to the associated clock pair.
- 11 **IRQ_H[5:0]** must have their TSU and TDH times referenced to **DCOK_H** during power-up to ensure the correct Y divider and resulting **EV6Clk_x** duty cycle. When the 21264/EV68A is executing instructions **IRQ_H[5:0]** act as normal asynchronous pins to handle interrupts.
- 12 **Reset_L** is an asynchronous pin. It may be asserted asynchronously.
- 13 **DCOK_H** is an asynchronous pin. Note the minimum slew rate on the assertion edge.
- 14 **PllBypass_H** may not switch when **ClkIn_x** is running. This pin must either be deasserted during power-up or the 21264/EV68A core power pin (**VDD** pins) indicating the 21264/EV68A's internal PLL will be used. Note that it is illegal to use **PllBypass_H** asserted during power-up unless a **ClkIn_x** is present.
- 15 See Section 7.11.2 for a discussion of **ClkIn_x** as it relates to operating the 21264/EV68A's internal PLL versus running the 21264/EV68A in PLL bypass mode. **ClkIn_x** has specific input jitter requirements to ensure optimum performance of the internal 21264/EV68A PLL.
- 16 In PLL bypass mode, duty cycle deviation from 50%–50% directly degrades device operating frequency.
- 17 The TSU and TDH of **FrameClk_x** are referenced to the deasserting edge of **ClkIn_x**.
- 18 This signal is a feedback to the internal PLL and may be monitored for overall 21264/EV68A jitter. It can also be used as a feedback signal to an external PLL when in PLL bypass mode. Proper termination of **EV6Clk_x** is imperative.
- 19 The cycle or phase cannot be more than 5% shorter than the nominal. Do not confuse this measurement with duty cycle.
- 20 The period for **SromClk_H** is 256 GCLK cycles.
- 21 When **Trst_L** is deasserted, **Tms_H** must not change state. **Trst_L** is asserted asynchronously but may be deasserted synchronously.

This chapter describes the 21264/EV68A thermal management and thermal design considerations, and is organized as follows:

- Operating temperature
- Heat sink specifications
- Thermal design considerations

10.1 Operating Temperature

The 21264/EV68A is specified to operate when the temperature at the center of the heat sink (T_c) is as shown in Table 10–1. Temperature T_c should be measured at the center of the heat sink, between the two package studs. The GRAFOIL pad is the interface material between the package and the heat sink.

Table 10–1 Operating Temperature at Heat Sink Center (T_c)

T_c	Frequency
80.8° C	750 MHz
78.6° C	833 MHz
77.6° C	875 MHz
76.0° C	940 MHz

Note: Compaq recommends using the heat sink because it reduces overheating that causes thermal failure.

Operating Temperature

Table 10–2 lists the values for the center of heat-sink-to-ambient (θ_{ca}) for the 21264/EV68A 587-pin PGA. Tables 10–3 through 10–6 show the allowable T_a (without exceeding T_c) at various airflows.

Table 10–2 θ_{ca} at Various Airflows for 21264/EV68A

Airflow (linear ft/min)	200	400	600	800
θ_{ca} with heat sink type 1 ($^{\circ}\text{C}/\text{W}$)	0.68	0.42	0.36	0.33
θ_{ca} with heat sink type 2 ($^{\circ}\text{C}/\text{W}$)	0.62	0.35	0.28	0.25
θ_{ca} with heat sink type 3 ¹ ($^{\circ}\text{C}/\text{W}$)	— 0.32 —			

¹ Heat sink type 3 has a 80 mm × 80 mm × 15 mm fan attached.

Table 10–3 Maximum T_a for 21264/EV68A @ 750 MHz and @ 1.7 V with Various Airflows

Airflow (linear ft/min)	200	400	600	800
Maximum T_a with heat sink type 1 ($^{\circ}\text{C}$)	40.0	55.6	59.2	61.0
Maximum T_a with heat sink type 2 ($^{\circ}\text{C}$)	43.6	59.8	64.0	65.8
Maximum T_a with heat sink type 3 ¹ ($^{\circ}\text{C}$)	— 61.6 —			

¹ Heat sink type 3 has a 80 mm × 80 mm × 15 mm fan attached.

Table 10–4 Maximum T_a for 21264/EV68A @ 833 MHz and @ 1.7 V with Various Airflows

Airflow (linear ft/min)	200	400	600	800
Maximum T_a with heat sink type 1 ($^{\circ}\text{C}$)	33.0	50.4	54.4	56.5
Maximum T_a with heat sink type 2 ($^{\circ}\text{C}$)	37.0	55.1	59.8	61.8
Maximum T_a with heat sink type 3 ¹ ($^{\circ}\text{C}$)	— 57.1 —			

¹ Heat sink type 3 has a 80 mm × 80 mm × 15 mm fan attached.

Table 10–5 Maximum T_a for 21264/EV68A @ 875 MHz and @ 1.7 V with Various Airflows

Airflow (linear ft/min)	200	400	600	800
Maximum T_a with heat sink type 1 ($^{\circ}\text{C}$)	30.0	48.2	52.4	54.5
Maximum T_a with heat sink type 2 ($^{\circ}\text{C}$)	34.2	53.1	58.0	60.1
Maximum T_a with heat sink type 3 ¹ ($^{\circ}\text{C}$)	— 55.2 —			

¹ Heat sink type 3 has a 80 mm × 80 mm × 15 mm fan attached.

Table 10–6 Maximum T_a for 21264/EV68A @ 940 MHz and @ 1.7 V with Various Airflows

Airflow (linear ft/min)	200	400	600	800
Maximum T_a with heat sink type 1 ($^{\circ}\text{C}$)	25.0	44.5	49.0	51.3
Maximum T_a with heat sink type 2 ($^{\circ}\text{C}$)	29.5	49.8	55.0	57.3
Maximum T_a with heat sink type 3 ¹ ($^{\circ}\text{C}$)	— 52.0 —			

¹ Heat sink type 3 has a 80 mm × 80 mm × 15 mm fan attached.

10.2 Heat Sink Specifications

Three heat sink types are specified. The mounting holes for all three are in line with the cooling fins.

Figure 10–1 shows the heat sink type 1, along with its approximate dimensions.

Figure 10–1 Type 1 Heat Sink

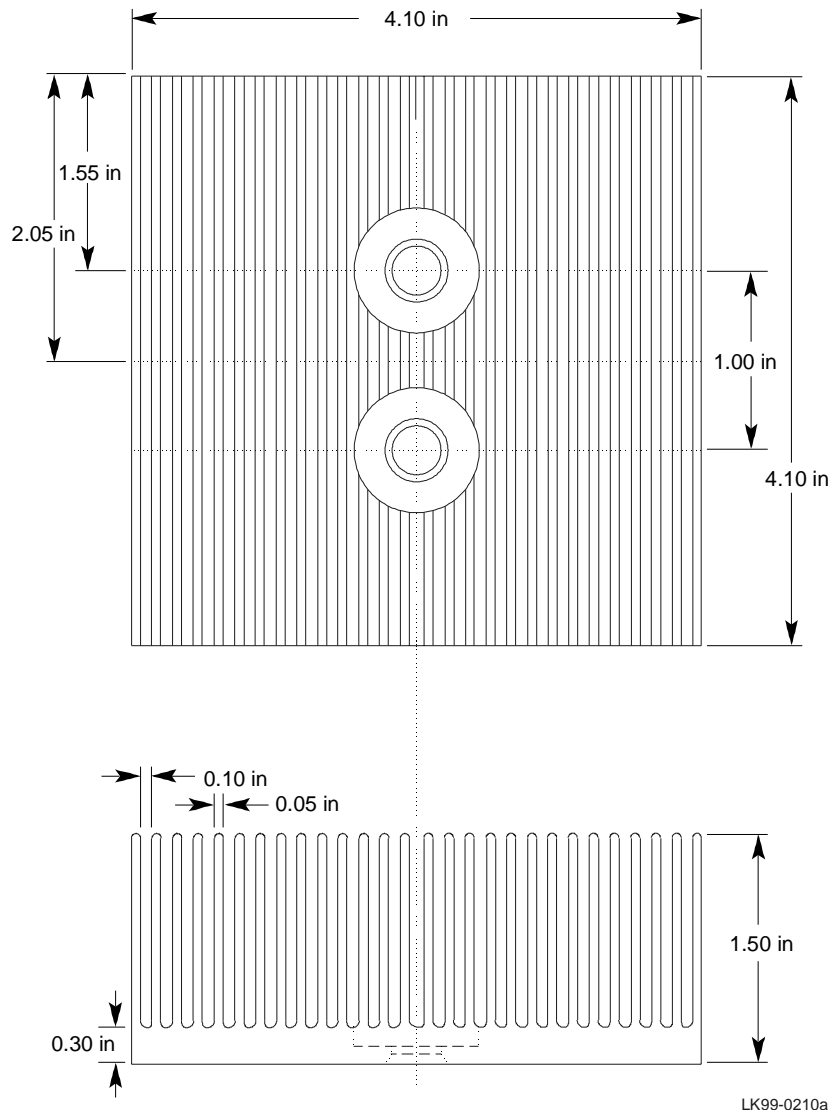

Heat Sink Specifications

Figure 10–2 shows the heat sink type 2, along with its approximate dimensions.

Figure 10–2 Type 2 Heat Sink

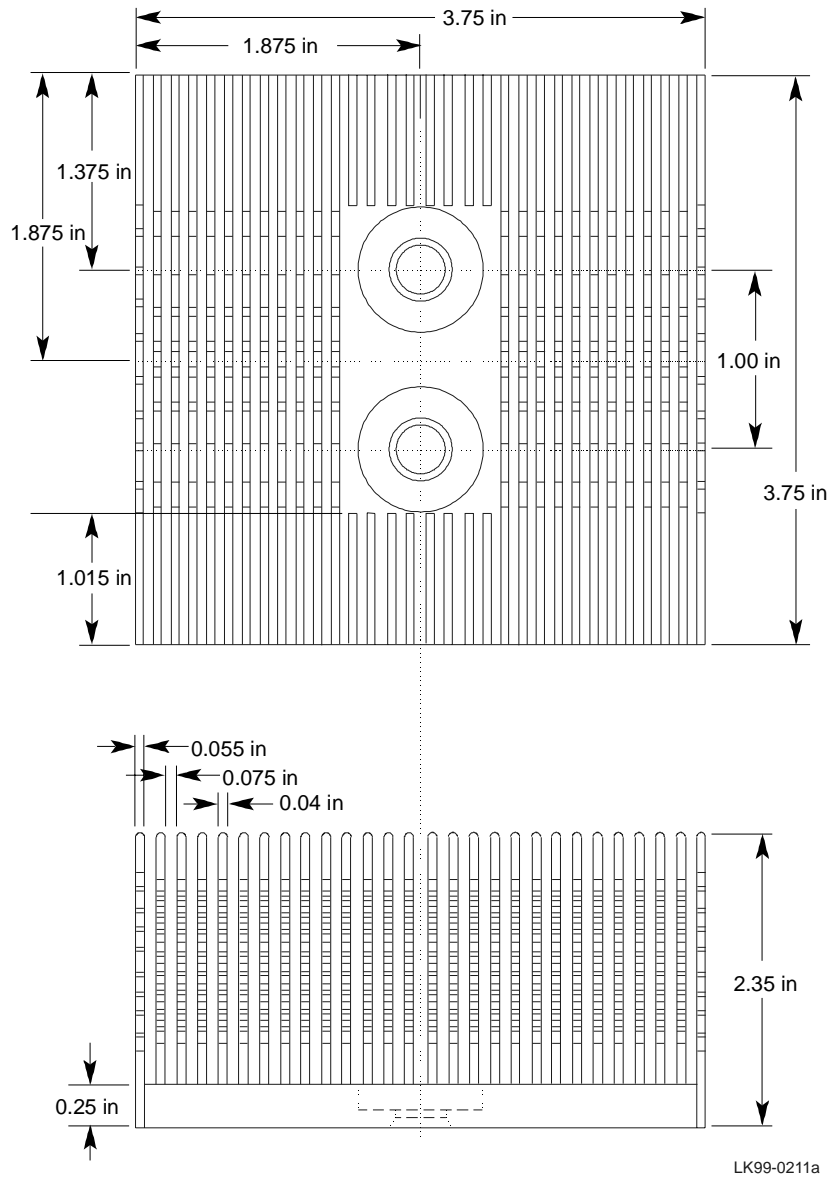
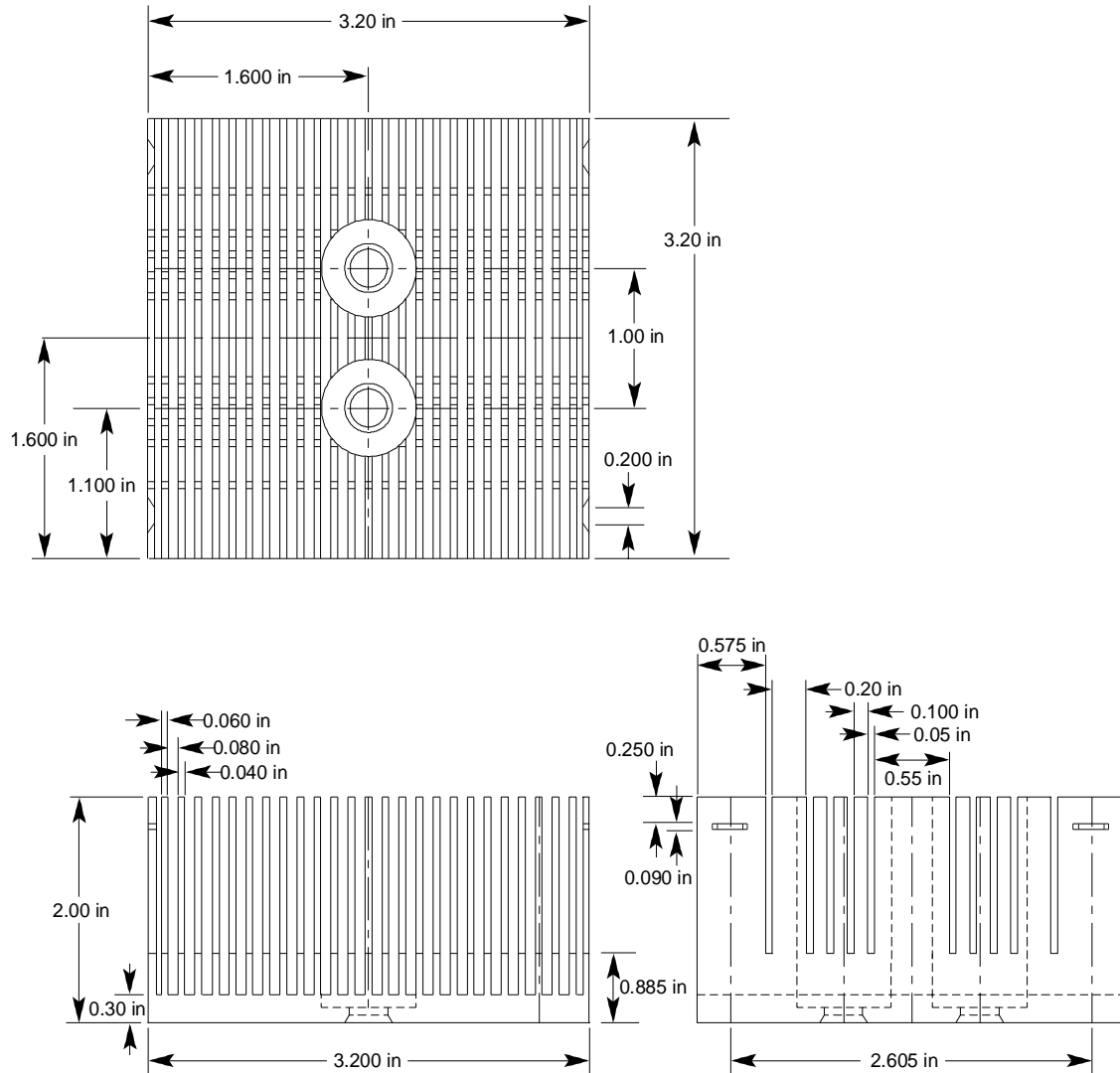

Figure 10–3 shows heat sink type 3, along with its approximate dimensions.

The cooling fins of heat sink type 3 are cross-cut. Also, an 80 mm × 80 mm × 15 mm fan is attached to heat sink type 3.

Figure 10–3 Type 3 Heat Sink



LK99-0212a

10.3 Thermal Design Considerations

Follow these guidelines for printed circuit board (PCB) component placement:

- Orient the 21264/EV68A on the PCB with the heat sink fins aligned with the air-flow direction.
- Avoid preheating ambient air. Place the 21264/EV68A on the PCB so that inlet air is not preheated by any other PCB components.
- Do not place other high power devices in the vicinity of the 21264/EV68A.

Do not restrict the airflow across the 21264/EV68A heat sink. Placement of other devices must allow for maximum system airflow in order to maximize the performance of the heat sink.

Testability and Diagnostics

This chapter describes the 21264/EV68A user-oriented testability and diagnostic features. These features include automatic power-up self-test, Icache initialization from external serial ROMs, and the serial diagnostic terminal port.

The boundary-scan register, which is another testability and diagnostic feature, is listed in Appendix B. The boundary-scan register is compatible with IEEE Standard 1149.1.

This chapter is organized as follows:

- Test pins
- SROM/serial diagnostic terminal port
- IEEE 1149.1 port
- TestStat_H pin
- Power-up self-test and initialization
- Notes on IEEE 1149.1 operation and compliance

The 21264/EV68A has several manufacturing test features that are used only by the factory, and they are beyond the scope of this chapter.

11.1 Test Pins

The 21264/EV68A test access ports include the IEEE 1149.1 test access port, a dual-purpose SROM/Serial diagnostic terminal port, and a test status output pin. Table 11–1 lists the test access port pins.

Table 11–1 Dedicated Test Port Pins

Pin Name	Type	Function
Tms_H	Input	IEEE 1149.1 test mode select
Tdi_H	Input	IEEE 1149.1 test data in
Trst_L	Input	IEEE 1149.1 test logic reset
Tck_H	Input	IEEE 1149.1 test clock
Tdo_H	Output	IEEE 1149.1 test data output
SromData_H	Input	SROM data/Diagnostic terminal data input

Table 11–1 Dedicated Test Port Pins (Continued)

Pin Name	Type	Function
SromClk_H	Output	SROM clock/Diagnostic terminal data output
SromOE_L	Output	SROM enable/Diagnostic terminal enable
TestStat_H	Output	BiST status/timeout output

11.2 SROM/Serial Diagnostic Terminal Port

This port supports two functions. During power-up, it supports automatic initialization of the Cbox configuration registers and the Icache from the system serial ROMs. After power-up, it supports a serial diagnostic terminal.

11.2.1 SROM Load Operation

The following actions are performed while the SROM is loaded:

- The **SromOE_L** pin supplies the output enable as well as the reset to the serial ROM. (Refer to the serial ROM specifications for details.) The 21264/EV68A asserts this signal low for the duration of the Icache load from the serial ROM. When the load has been completed, the signal remains deasserted.
- The **SromClk_H** pin supplies the clock to the SROM that causes it to advance to the next bit. Simultaneously, it causes the existing data on the **SromData_H** pin to be shifted into an internal shift register. The cycle time of this clock is 256 times the CPU clock rate. (If the FASTROM flag is set, the rate is 16 times the CPU clock rate.) The hold time on **SromData_H** is 2* CPU cycle time with respect to **SromClk_H**.
- The **SromData_H** pin reads data from the SROM.

Every data and tag bit in Icache is loaded by that sequence.

11.2.2 Serial Terminal Port

After the SROM data is loaded into the Icache, the three SROM interface signals can be used as a software UART and the pins become parallel I/O pins that can drive a system debug or diagnostic terminal by using an interface such as RS422.

The serial line interface is automatically enabled if the **SromOE_L** pin is wired to the following pins:

- An active high enable RS422 (or 26LS32) driver, driving to **SromData_H**
- An active high enable RS422 (or 26LS31) receiver, driven from **SromClk_H**

After reset, **SromClk_H** is driven from the Ibox **I_CTL[SL_XMIT]**. This register is cleared during reset, so it starts driving as a 0, but it can be written by software. The data becomes available at the pin after the **HW_MTPR** instruction that wrote **I_CTL[SL_XMIT]** is retired.

On the receive side, while in native mode, any transition on the Ibox I_CTL [SL_RCV], driven from the **SromData_H** pin, results in a trap to the PALcode interrupt handler. When in PALmode, all interrupts are blocked. The interrupt routine then begins sampling I_CTL [SL_RCV] under a software timing loop to input as much data as needed, using the chosen serial line protocol.

11.3 IEEE 1149.1 Port

The IEEE 1149.1 Test Access Port consists of the **Tdi_H**, **Tdo_H**, **Tms_H**, **Tck_H**, and **Trst_L** pins. These pins access the IEEE 1149.1 mandated public test features as well as several private chip manufacturing test features.

The port meets all requirements of the standard except that there are no pull-ups on the **Tdi_H**, **Tms_H**, and **Trst_L** pins, as required by the present standard.

The scope of 1149.1 compliant features on the 21264/EV68A is limited to the board level assembly verification test. The systems that do not intend to drive this port must terminate the port pins as follows: pull-ups on **Tdi_H** and **Tms_H**, pull-downs on **Tck_H** and **Trst_L**.

The port logic consists of the usual standard compliant components, namely, the TAP Controller State Machine, the Instruction Register, and the Bypass Register.

The Bypass Register provides a short shift path through the chip's IEEE 1149.1 logic. It is generally useful at the board level testing. It consists of a 1-bit shift register.

The Instruction Register holds test instructions. On the 21264/EV68A, this register is 5 bits wide. Table 11–2 describes the supported instructions. The instruction set supports several public and private instructions. The public instructions operate and produce behavior compliant with the standard. The private instructions are used for chip manufacturing test and must not be used outside of chip manufacturing.

Table 11–2 IEEE 1149.1 Instructions and Opcodes

Opcode	Instruction	Operation/Function
00xxx 01xxx 10xxx	Private	These instructions are for factory test use only. The user must not load them as they may have a harmful effect on the 21264/EV68A.
11000	SAMPLE	IEEE 1149.1 SAMPLE instruction.
11001	HIGHZ	IEEE 1149.1 HIGHZ instruction.
11010	CLAMP	IEEE 1149.1 CLAMP instruction.
11011	EXTEST	IEEE 1149.1 EXTEST instruction.
11100 11101 11110	Private	These instructions are for factory test use only. The user must not load them as they may have a harmful effect on the 21264/EV68A.
11111	BYPASS	IEEE 1149.1 BYPASS instruction.

Figure 11–3 shows the TAP controller state machine state diagram. The signal **Tms_H** controls the state transitions that occur with the rising clock edge. TAP state machine states are decoded and used for initiating various actions for testing.

Table 11–3 TAP Controller State Machine

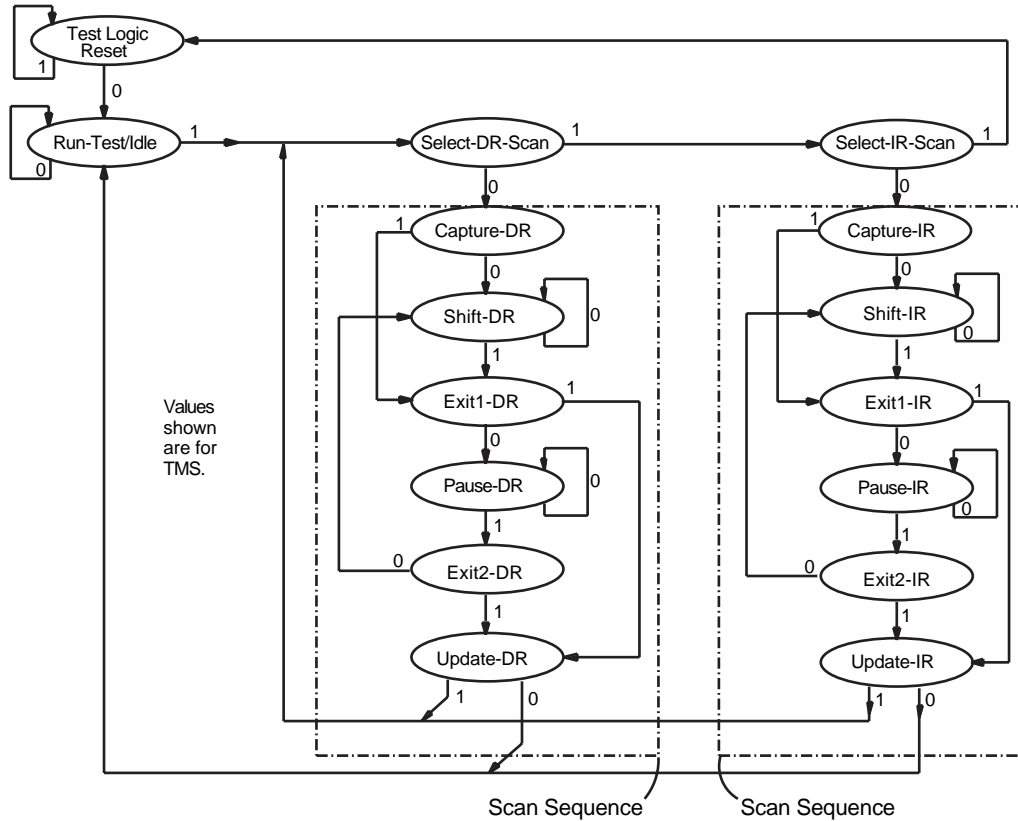

MK145508.A14

11.4 TestStat_H Pin

The **TestStat_H** pin serves two purposes. During power-up, it indicates BiST pass/fail status. After power-up, it indicates the 21264/EV68A timeout event.

The system reset forces **TestStat_H** to low. Tbox forces it high during the internal BiST and array initialization operations. During result extraction (DoResult state), the Tbox drives it low for 16 cycles. After that, the pin remains low if the BiST has passes, otherwise, it is asserted high and remains high until chip is reset again. Figure 11–1 pictorially shows the behavior of the pin during the power-up operations.

Note: A system designer may sample the **TestStat_H** pin on the first rising edge of the **SromClk_H** pin to determine BiST results. After the power-up during the normal chip operation, whenever the 21264/EV68A does not retire an instruction for 2K CPU cycles, the pin is asserted high for 3 CPU cycles.

Figure 11–1 TestStat_H Pin Timing During Power-Up Built-In Self-Test (BiST)

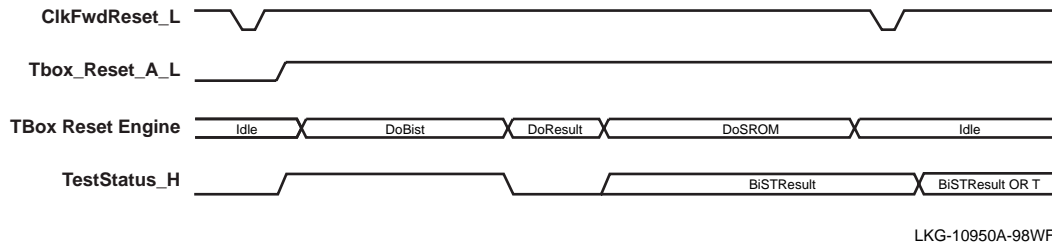
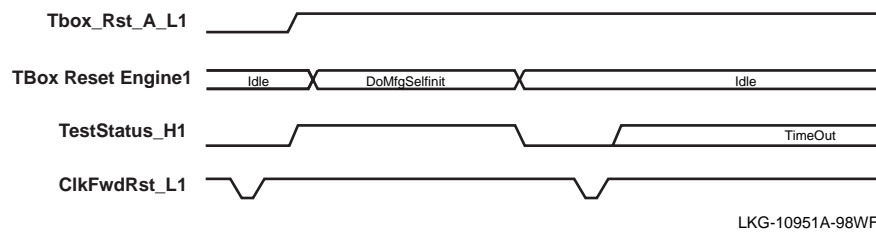

Figure 11–2 TestStat_H Pin Timing During Built-In Self-Initialization (BiSI)



11.5 Power-Up Self-Test and Initialization

Upon powering up, the 21264/EV68A automatically performs the self-test of all major embedded RAM arrays and then loads the Cbox configuration registers and the instruction cache from the system SROM. The chip's internal logic is held in reset during these operations. See Chapter 9 for sequencing of power-up operations.

11.5.1 Built-in Self-Test

The power-up self-test is performed on the instruction cache and tag arrays, the data cache and tag arrays, the triplicate tag arrays, and the various RAM arrays located in the branch history table logic. The power-up self-test lasts for approximately 700,000 CPU cycles. The result of self-test is made available as Pass/Fail status on the **TestStat_H** pin (see Section 11.4).

The result of self-test is also available in an IPR bit. Software can read this status through IPR I_CTL(23) (0 = pass, 1 = fail). See Section 5.2.15.

The power-up BiST leaves all bits in all arrays initialized to zeroes. The instruction cache and the tag are reinitialized as part of the SROM initialization step. This is detailed in Section 11.5.2.

11.5.2 SROM Initialization

Power-up initialization on the 21264/EV68A is different from previous generation Alpha systems in two aspects. First, in the 21264/EV68A systems, the presence of serial ROMs is mandatory as initialization of several Cbox configuration registers depends on them. Second, it is possible to skip or partially fill Icache from serial ROMs. Figure 11–3 shows the map of the data in serial ROMs.

Power-Up Self-Test and Initialization

In the SROM represented in Figure 11–3, the length for fields Cbox Config Data(0,n) plus MBZ(m,0) must equal 367 bits. (If Cbox Config Data(0,n) is (0,366), MBZ would be zero.)

For the 21264/EV68A, Cbox Config Data is 304 bits; the value for n is 303.

Therefore, the value MBZ field for Pass 3 is:

$$\text{MBZ}(m,0) = 367 \text{ minus } 304 = 63 = (62,0)$$

Tables 11–4 and 5–24 describe the details of the Icache and Cbox bit fields, respectively. Note that $\text{fetch_count}(1,0)$ must be 3, which guarantees that the SROM never partially loads an Icache block.

Figure 11–3 SROM Content Map

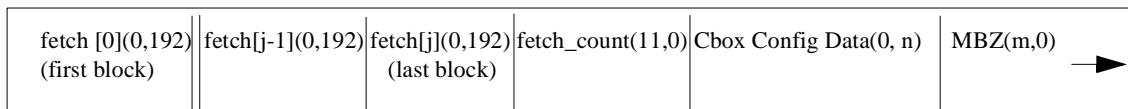

11.5.2.1 Serial Instruction Cache Load Operation

All Icache bits, including each block's tag, address space number (ASN), address space match (ASM), and valid and branch history bits are loaded serially from offchip serial ROMs. Once the serial load has been invoked by the chip reset sequence, the cache is loaded from the lower to the higher addresses.

The serial Icache fill invoked by the chip reset sequence operates internally at a frequency of $\frac{\text{GCLK}}{256}$.

Table 11–4 lists the Icache bit fields in an SROM line. Fetch bits are listed in the order of shift direction (to down and to right). In Table 11–4:

Bit Type	Meaning
c	Disp_add carry
i	Instruction
iq	Iqueue predecodes
tr	Trouble bits
dv	Destination valid
ea	Ea_src
par-MBZ	Must be zero

The load occurs at the rate of 1 bit per 256 CPU cycles. The chip outputs a 50% duty cycle clock on the **SromClk_H** pin.

The serial ROMs can contain enough Alpha code to complete the configuration of the external interface (for example, set the timing on the external cache RAMs, and diagnose the path between the CPU chip and the real ROM).

The instruction cache lines are loaded in the reverse order. If the `fetch_count(9,0)` is zero, then, no instruction cache lines are loaded. Since the valid bits are already cleared by the BiST operation, the first instruction fetch is missed in the instruction cache and the chip seeks instructions from the offchip memory.

Table 11–4 Icache Bit Fields in an SROM Line

Fetch Bit	Icache Data	Fetch Bit	Icache Data	Fetch Bit	Icache Data
0	par-MBZ	86	par-MBZ	172	lp_train
1	c[3]	87	c[0]	173:175	lp_src(2:0)
2:27	i[3](25,20,24,19,23,18,22,17,21,16:0)	88:113	i[0](25,20,24,19,3,18,22,17,21,16:0)	176:181	lp_idx(14:9)
28	c[2]	114	c[1]	182:186	lp_idx(8:4)
29:42	i[2](25,20,24,19,23,18,22,17,21,16:12)	115:128	i[1](25,20,24,19,23,18,22,17,21,16:12)	187	lp_idx(15)
43	parity	129	parity	188:192	lp_ssp[4:0]
44:55	i[2](11:0)	130:141	i[1](11:0)	—	—
56	dv[3]	142	dv[0]	—	—
57:59	iq[3](2:0)	143:145	iq[0](2:0)	—	—
60:65	i[3](26:31)	146:151	i[0](26:31)	—	—
66,68	ea[3](2:0)	152:154	ea[0](2:0)	—	—
69	dv[2]	155	dv[1]	—	—
70,72	iq[2](2:0)	156:158	iq[1](2:0)	—	—
73:78	i[2](26:31)	159:164	i[1](26:31)	—	—
79:81	ea[2](2:0)	165:167	ea[1](2:0)	—	—
82:85	tr(7:4)	168:171	tr(0:3)	—	—

Refer to the Alpha Motherboards Software Developer's Kit (SDK) for example C code that calculates the predecode values of a serial Icache load.

11.6 Notes on IEEE 1149.1 Operation and Compliance

1. IEEE 1149.1 port pins on the 21264/EV68A are not pulled up or pulled down on the chip. The necessary pull-up or pull-down function must be implemented on the board.
2. **Tms_H** should not change when **Trst_L** is being deasserted.

References

IEEE Std. 1149.1-1993 *A Test Access Port and Boundary Scan Architecture*.

See Appendix B for a listing of the Boundary-Scan Register.

Alpha Instruction Set

This appendix provides a summary of the Alpha instruction set and describes the 21264/EV68A IEEE floating-point conformance. It is organized as follows:

- Alpha instruction summary
- Reserved opcodes
- IEEE floating-point instructions
- VAX floating-point instructions
- Independent floating-point instructions
- Opcode summary
- Required PALcode function codes
- IEEE floating-point conformance

A.1 Alpha Instruction Summary

This section contains a summary of all Alpha architecture instructions. All values are in hexadecimal radix. Table A–1 describes the contents of the Format and Opcode columns that are in Table A–2.

Table A–1 Instruction Format and Opcode Notation

Instruction Format	Format Symbol	Opcode Notation	Meaning
Branch	Bra	oo	oo is the 6-bit opcode field.
Floating-point	F-P	oo.fff	oo is the 6-bit opcode field. fff is the 11-bit function code field.
Memory	Mem	oo	oo is the 6-bit opcode field.
Memory/function code	Mfc	oo.ffff	oo is the 6-bit opcode field. ffff is the 16-bit function code in the displacement field.

Alpha Instruction Summary

Table A–1 Instruction Format and Opcode Notation (Continued)

Instruction Format	Format Symbol	Opcode Notation	Meaning
Memory/ branch	Mbr	oo.h	<i>oo</i> is the 6-bit opcode field. <i>h</i> is the high-order 2 bits of the displacement field.
Operate	Opr	oo.ff	<i>oo</i> is the 6-bit opcode field. <i>ff</i> is the 7-bit function code field.
PALcode	Pcd	oo	<i>oo</i> is the 6-bit opcode field; the particular PAL-code instruction is specified in the 26-bit function code field.

Qualifiers for operate instructions are shown in Table A–2. Qualifiers for IEEE and VAX floating-point instructions are shown in Tables A–5 and A–6, respectively.

Table A–2 Architecture Instructions

Mnemonic	Format	Opcode	Description
ADDF	F-P	15.080	Add F_floating
ADDG	F-P	15.0A0	Add G_floating
ADDL	Opr	10.00	Add longword
ADDL/V	Opr	10.40	Add longword with integer overflow enable
ADDQ	Opr	10.20	Add quadword
ADDQ/V	Opr	10.60	Add quadword with integer overflow enable
ADDS	F-P	16.080	Add S_floating
ADDT	F-P	16.0A0	Add T_floating
AMASK	Opr	11.61	Architecture mask
AND	Opr	11.00	Logical product
BEQ	Bra	39	Branch if = zero
BGE	Bra	3E	Branch if ≥ zero
BGT	Bra	3F	Branch if > zero
BIC	Opr	11.08	Bit clear
BIS	Opr	11.20	Logical sum
BLBC	Bra	38	Branch if low bit clear
BLBS	Bra	3C	Branch if low bit set
BLE	Bra	3B	Branch if ≤ zero
BLT	Bra	3A	Branch if < zero
BNE	Bra	3D	Branch if ≠ zero
BR	Bra	30	Unconditional branch

Table A–2 Architecture Instructions (Continued)

Mnemonic	Format	Opcode	Description
BSR	Mbr	34	Branch to subroutine
CALL_PAL	Pcd	00	Trap to PALcode
CMOVEQ	Opr	11.24	CMOVE if = zero
CMOVGE	Opr	11.46	CMOVE if \geq zero
CMOVGT	Opr	11.66	CMOVE if > zero
CMOVLBC	Opr	11.16	CMOVE if low bit clear
CMOVLBS	Opr	11.14	CMOVE if low bit set
CMOVLE	Opr	11.64	CMOVE if \leq zero
CMOVLT	Opr	11.44	CMOVE if < zero
CMOVNE	Opr	11.26	CMOVE if \neq zero
CMPBGE	Opr	10.0F	Compare byte
CMPEQ	Opr	10.2D	Compare signed quadword equal
CMPGEQ	F-P	15.0A5	Compare G_floating equal
CMPGLE	F-P	15.0A7	Compare G_floating less than or equal
CMPGLT	F-P	15.0A6	Compare G_floating less than
CMPLE	Opr	10.6D	Compare signed quadword less than or equal
CMPLT	Opr	10.4D	Compare signed quadword less than
CMPTEQ	F-P	16.0A5	Compare T_floating equal
CMPTLE	F-P	16.0A7	Compare T_floating less than or equal
CMPTLT	F-P	16.0A6	Compare T_floating less than
CMPTUN	F-P	16.0A4	Compare T_floating unordered
CMPULE	Opr	10.3D	Compare unsigned quadword less than or equal
CMPULT	Opr	10.1D	Compare unsigned quadword less than
CPYS	F-P	17.020	Copy sign
CPYSE	F-P	17.022	Copy sign and exponent
CPYSN	F-P	17.021	Copy sign negate
CTLZ	Opr	1C.32	Count leading zero
CTPOP	Opr	1C.30	Count population
CTTZ	Opr	1C.33	Count trailing zero
CVTDG	F-P	15.09E	Convert D_floating to G_floating
CVTGD	F-P	15.0AD	Convert G_floating to D_floating
CVTGF	F-P	15.0AC	Convert G_floating to F_floating

Alpha Instruction Summary

Table A–2 Architecture Instructions (Continued)

Mnemonic	Format	OpcodE	Description
CVTGQ	F-P	15.0AF	Convert G_floating to quadword
CVTLQ	F-P	17.010	Convert longword to quadword
CVTQF	F-P	15.0BC	Convert quadword to F_floating
CVTQG	F-P	15.0BE	Convert quadword to G_floating
CVTQL	F-P	17.030	Convert quadword to longword
CVTQS	F-P	16.0BC	Convert quadword to S_floating
CVTQT	F-P	16.0BE	Convert quadword to T_floating
CVTST	F-P	16.2AC	Convert S_floating to T_floating
CVTTQ	F-P	16.0AF	Convert T_floating to quadword
CVTTS	F-P	16.0AC	Convert T_floating to S_floating
DIVF	F-P	15.083	Divide F_floating
DIVG	F-P	15.0A3	Divide G_floating
DIVS	F-P	16.083	Divide S_floating
DIVT	F-P	16.0A3	Divide T_floating
ECB	Mfc	18.E800	Evict cache block
EQV	Opr	11.48	Logical equivalence
EXCB	Mfc	18.0400	Exception barrier
EXTBL	Opr	12.06	Extract byte low
EXTLH	Opr	12.6A	Extract longword high
EXTLL	Opr	12.26	Extract longword low
EXTQH	Opr	12.7A	Extract quadword high
EXTQL	Opr	12.36	Extract quadword low
EXTWH	Opr	12.5A	Extract word high
EXTWL	Opr	12.16	Extract word low
FBEQ	Bra	31	Floating branch if = zero
FBGE	Bra	36	Floating branch if ≥ zero
FBGT	Bra	37	Floating branch if > zero
FBLE	Bra	33	Floating branch if ≤ zero
FBLT	Bra	32	Floating branch if < zero
FBNE	Bra	35	Floating branch if ≠ zero
FCMOVEQ	F-P	17.02A	FCMOVE if = zero
FCMOVGE	F-P	17.02D	FCMOVE if ≥ zero

Table A-2 Architecture Instructions (Continued)

Mnemonic	Format	Opcode	Description
FCMOVGT	F-P	17.02F	FCMOVE if > zero
FCMOVLE	F-P	17.02E	FCMOVE if ≤ zero
FCMOVLT	F-P	17.02C	FCMOVE if < zero
FCMOVNE	F-P	17.02B	FCMOVE if ≠ zero
FETCH	Mfc	18.8000	Prefetch data
FETCH_M	Mfc	18.A000	Prefetch data, modify intent
FTOIS	F-P	1C.78	Floating to integer move, S_floating
FTOIT	F-P	1C.70	Floating to integer move, T_floating
IMPLVER	Opr	11.6C	Implementation version
INSBL	Opr	12.0B	Insert byte low
INSLH	Opr	12.67	Insert longword high
INSLL	Opr	12.2B	Insert longword low
INSQH	Opr	12.77	Insert quadword high
INSQL	Opr	12.3B	Insert quadword low
INSWH	Opr	12.57	Insert word high
INSWL	Opr	12.1B	Insert word low
ITOFF	F-P	14.014	Integer to floating move, F_floating
ITOFS	F-P	14.004	Integer to floating move, S_floating
ITOFT	F-P	14.024	Integer to floating move, T_floating
JMP	Mbr	1A.0	Jump
JSR	Mbr	1A.1	Jump to subroutine
JSR_COROUTINE	Mbr	1A.3	Jump to subroutine return
LDA	Mem	08	Load address
LDAH	Mem	09	Load address high
LDBU	Mem	0A	Load zero-extended byte
LDF	Mem	20	Load F_floating
LDG	Mem	21	Load G_floating
LDL	Mem	28	Load sign-extended longword
LDL_L	Mem	2A	Load sign-extended longword locked
LDQ	Mem	29	Load quadword
LDQ_L	Mem	2B	Load quadword locked
LDQ_U	Mem	0B	Load unaligned quadword

Alpha Instruction Summary

Table A–2 Architecture Instructions (Continued)

Mnemonic	Format	Opcode	Description
LDS	Mem	22	Load S_floating
LDT	Mem	23	Load T_floating
LDWU	Mem	0C	Load zero-extended word
MAXSB8	Opr	1C.3E	Vector signed byte maximum
MAXSW4	Opr	1C.3F	Vector signed word maximum
MAXUB8	Opr	1C.3C	Vector unsigned byte maximum
MAXUW4	Opr	1C.3D	Vector unsigned word maximum
MB	Mfc	18.4000	Memory barrier
MF_FPCR	F-P	17.025	Move from FPCR
MINSB8	Opr	1C.38	Vector signed byte minimum
MINSW4	Opr	1C.39	Vector signed word minimum
MINUB8	Opr	1C.3A	Vector unsigned byte minimum
MINUW4	Opr	1C.3B	Vector unsigned word minimum
MSKBL	Opr	12.02	Mask byte low
MSKLH	Opr	12.62	Mask longword high
MSKLL	Opr	12.22	Mask longword low
MSKQH	Opr	12.72	Mask quadword high
MSKQL	Opr	12.32	Mask quadword low
MSKWH	Opr	12.52	Mask word high
MSKWL	Opr	12.12	Mask word low
MT_FPCR	F-P	17.024	Move to FPCR
MULF	F-P	15.082	Multiply F_floating
MULG	F-P	15.0A2	Multiply G_floating
MULL	Opr	13.00	Multiply longword
MULL/V	Opr	13.40	Multiply longword with integer overflow enable
MULQ	Opr	13.20	Multiply quadword
MULQ/V	Opr	13.60	Multiply quadword with integer overflow enable
MULS	F-P	16.082	Multiply S_floating
MULT	F-P	16.0A2	Multiply T_floating
ORNOT	Opr	11.28	Logical sum with complement
PERR	Opr	1C.31	Pixel error
PKLB	Opr	1C.37	Pack longwords to bytes

Table A–2 Architecture Instructions (Continued)

Mnemonic	Format	Opcode	Description
PKWB	Opr	1C.36	Pack words to bytes
RC	Mfc	18.E000	Read and clear
RET	Mbr	1A.2	Return from subroutine
RPCC	Mfc	18.C000	Read process cycle counter
RS	Mfc	18.F000	Read and set
S4ADDL	Opr	10.02	Scaled add longword by 4
S4ADDQ	Opr	10.22	Scaled add quadword by 4
S4SUBL	Opr	10.0B	Scaled subtract longword by 4
S4SUBQ	Opr	10.2B	Scaled subtract quadword by 4
S8ADDL	Opr	10.12	Scaled add longword by 8
S8ADDQ	Opr	10.32	Scaled add quadword by 8
S8SUBL	Opr	10.1B	Scaled subtract longword by 8
S8SUBQ	Opr	10.3B	Scaled subtract quadword by 8
SEXTB	Opr	1C.00	Sign extend byte
SEXTW	Opr	1C.01	Sign extend word
SLL	Opr	12.39	Shift left logical
SQRTF	F-P	14.08A	Square root F_floating
SQRTG	F-P	14.0AA	Square root G_floating
SQRTS	F-P	14.08B	Square root S_floating
SQRTT	F-P	14.0AB	Square root T_floating
SRA	Opr	12.3C	Shift right arithmetic
SRL	Opr	12.34	Shift right logical
STB	Mem	0E	Store byte
STF	Mem	24	Store F_floating
STG	Mem	25	Store G_floating
STL	Mem	2C	Store longword
STL_C	Mem	2E	Store longword conditional
STQ	Mem	2D	Store quadword
STQ_C	Mem	2F	Store quadword conditional
STQ_U	Mem	0F	Store unaligned quadword
STS	Mem	26	Store S_floating
STT	Mem	27	Store T_floating

Reserved Opcodes

Table A–2 Architecture Instructions (Continued)

Mnemonic	Format	Opcode	Description
STW	Mem	0D	Store word
SUBF	F-P	15.081	Subtract F_floating
SUBG	F-P	15.0A1	Subtract G_floating
SUBL	Opr	10.09	Subtract longword
SUBL/V	Opr	10.49	Subtract longword with integer overflow enable
SUBQ	Opr	10.29	Subtract quadword
SUBQ/V	Opr	10.69	Subtract quadword with integer overflow enable
SUBS	F-P	16.081	Subtract S_floating
SUBT	F-P	16.0A1	Subtract T_floating
TRAPB	Mfc	18.0000	Trap barrier
UMULH	Opr	13.30	Unsigned multiply quadword high
UNPKBL	Opr	1C.35	Unpack bytes to longwords
UNPKBW	Opr	1C.34	Unpack bytes to words
WH64	Mfc	18.F800	Write hint — 64 bytes
WMB	Mfc	18.4400	Write memory barrier
XOR	Opr	11.40	Logical difference
ZAP	Opr	12.30	Zero bytes
ZAPNOT	Opr	12.31	Zero bytes not

A.2 Reserved Opcodes

This section describes the opcodes that are reserved in the Alpha architecture. They can be reserved for Compaq or for PALcode.

A.2.1 Opcodes Reserved for Compaq

Table A–3 lists opcodes reserved for Compaq.

Table A–3 Opcodes Reserved for Compaq

Mnemonic	Opcode	Mnemonic	Opcode
OPC01	01	OPC05	05
OPC02	02	OPC06	06
OPC03	03	OPC07	07
OPC04	04	—	—

A.2.2 Opcodes Reserved for PALcode

Table A–4 lists the 21264/EV68A-specific instructions. See Chapter 2 for more information.

Table A–4 Opcodes Reserved for PALcode

21264/EV68A Mnemonic	Opcode	Architecture Mnemonic	Function
HW_LD	1B	PAL1B	Performs Dstream load instructions.
HW_ST	1F	PAL1F	Performs Dstream store instructions.
HW_REI	1E	PAL1E	Returns instruction flow to the program counter (PC) pointed to by EXC_ADDR internal processor register (IPR).
HW_MFPR	19	PAL19	Accesses the Ibox, Mbox, and Dcache IPRs.
HW_MTPR	1D	PAL1D	Accesses the Ibox, Mbox, and Dcache IPRs.

A.3 IEEE Floating-Point Instructions

Table A–5 lists the hexadecimal value of the 11-bit function code field for the IEEE floating-point instructions, with and without qualifiers. The opcode for these instructions is 16_{16} .

Table A–5 IEEE Floating-Point Instruction Function Codes

Mnemonic	None	/C	/M	/D	/U	/UC	/UM	/UD
ADDS	080	000	040	0C0	180	100	140	1C0
ADDT	0A0	020	060	0E0	1A0	120	160	1E0
CMPTEQ	0A5	—	—	—	—	—	—	—
CMPTLT	0A6	—	—	—	—	—	—	—
CMPTLE	0A7	—	—	—	—	—	—	—
CMPTUN	0A4	—	—	—	—	—	—	—
CVTQS	0BC	03C	07C	0FC	—	—	—	—
CVTQT	0BE	03E	07E	0FE	—	—	—	—
CVTST	See below	—	—	—	—	—	—	—
CVTTQ	See below	—	—	—	—	—	—	—
CVTTS	0AC	02C	06C	0EC	1AC	12C	16C	1EC
DIVS	083	003	043	0C3	183	103	143	1C3
DIVT	0A3	023	063	0E3	1A3	123	163	1E3
MULS	082	002	042	0C2	182	102	142	1C2
MULT	0A2	022	062	0E2	1A2	122	162	1E2

IEEE Floating-Point Instructions

Table A–5 IEEE Floating-Point Instruction Function Codes (Continued)

SQRTS	08B	00B	04B	0CB	18B	10B	14B	1CB
SQRTT	0AB	02B	06B	0EB	1AB	12B	16B	1EB
SUBS	081	001	041	0C1	181	101	141	1C1
SUBT	0A1	021	061	0E1	1A1	121	161	1E1
Mnemonic	/SU	/SUC	/SUM	/SUD	/SUI	/SUIC	/SUIM	/SUID
ADDS	580	500	540	5C0	780	700	740	7C0
ADDT	5A0	520	560	5E0	7A0	720	760	7E0
CMPTAQ	5A5							
CMPTLT	5A6							
CMPTLE	5A7							
CMPTUN	5A4							
CVTQS					7BC	73C	77C	7FC
CVTQT					7BE	73E	77E	7FE
CVTTS	5AC	52C	56C	5EC	7AC	72C	76C	7EC
DIVS	583	503	543	5C3	783	703	743	7C3
DIVT	5A3	523	563	5E3	7A3	723	763	7E3
MULS	582	502	542	5C2	782	702	742	7C2
MULT	5A2	522	562	5E2	7A2	722	762	7E2
SQRTS	58B	50B	54B	5CB	78B	70B	74B	7CB
SQRTT	5AB	52B	56B	5EB	7AB	72B	76B	7EB
SUBS	581	501	541	5C1	781	701	741	7C1
SUBT	5A1	521	561	5E1	7A1	721	761	7E1
Mnemonic	None	/S						
CVTST	2AC	6AC						
Mnemonic	None	/C	/V	/VC	/SV	/SVC	/SVI	/SVIC
CVTTQ	0AF	02F	1AF	12F	5AF	52F	7AF	72F
Mnemonic	D	/VD	/SVD	/SVID	/M	/VM	/SVM	/SVIM
CVTTQ	0EF	1EF	5EF	7EF	06F	16F	56F	76F

Programming Note:

In order to use CMPTxx with software completion trap handling, it is necessary to specify the /SU IEEE trap mode, even though an underflow trap is not possible. In order to use CVTQS or CVTQT with software completion trap handling, it is necessary to specify the /SUI IEEE trap mode, even though an underflow trap is not possible.

A.4 VAX Floating-Point Instructions

Table A–6 lists the hexadecimal value of the 11-bit function code field for the VAX floating-point instructions. The opcode for these instructions is 15₁₆.

Table A–6 VAX Floating-Point Instruction Function Codes

Mnemonic	None	/C	/U	/UC	/S	/SC	/SU	/SUC
ADDF	080	000	180	100	480	400	580	500
ADDG	0A0	020	1A0	120	4A0	420	5A0	520
CMPGEQ	0A5				4A5			
CMPGLE	0A7				4A7			
CMPGLT	0A6				4A6			
CVTDG	09E	01E	19E	11E	49E	41E	59E	51E
CVTGD	0AD	02D	1AD	12D	4AD	42D	5AD	52D
CVTGF	0AC	02C	1AC	12C	4AC	42C	5AC	52C
CVTGQ	See below							
CVTQF	0BC	03C						
CVTQG	0BE	03E						
DIVF	083	003	183	103	483	403	583	503
DIVG	0A3	023	1A3	123	4A3	423	5A3	523
MULF	082	002	182	102	482	402	582	502
MULG	0A2	022	1A2	122	4A2	422	5A2	522
SQRTF	08A	00A	18A	10A	48A	40A	58A	50A
SQRTG	0AA	02A	1AA	12A	4AA	42A	5AA	52A
SUBF	081	001	181	101	481	401	581	501
SUBG	0A1	021	1A1	121	4A1	421	5A1	521
Mnemonic	None	/C	/V	/VC	/S	/SC	/SV	/SVC
CVTGQ	0AF	02F	1AF	12F	4AF	42F	5AF	52F

A.5 Independent Floating-Point Instructions

Table A–7 lists the hexadecimal value of the 11-bit function code field for the floating-point instructions that are not directly tied to IEEE or VAX floating point. The opcode for the following instructions is 17₁₆.

Opcode Summary

Table A–7 Independent Floating-Point Instruction Function Codes

Mnemonic	None	/V	/SV
CPYS	020	—	—
CPYSE	022	—	—
CPYSN	021	—	—
CVTLQ	010	—	—
CVTQL	030	130	530
FCMOVEQ	02A	—	—
FCMOVGE	02D	—	—
FCMOVGT	02F	—	—
FCMOVLE	02E	—	—
FCMOVLT	02C	—	—
MF_FPCR	025	—	—
MT_FPCR	024	—	—

A.6 Opcode Summary

Table A–8 lists all Alpha opcodes from 00 (CALL_PAL) through 3F (BGT). In the table, the column headings that appear over the instructions have a granularity of 8_{16} . The rows beneath the Offset column supply the individual hexadecimal number to resolve that granularity.

If an instruction column has a 0 in the right (low) hexadecimal digit, replace that 0 with the number to the left of the backslash (\) in the Offset column on the instruction's row. If an instruction column has an 8 in the right (low) hexadecimal digit, replace that 8 with the number to the right of the backslash in the Offset column.

For example, the third row (2/A) under the 10_{16} column contains the symbol INTS*, representing the all-integer shift instructions. The opcode for those instructions would then be 12_{16} because the 0 in 10 is replaced by the 2 in the Offset column. Likewise, the third row under the 18_{16} column contains the symbol JSR*, representing all jump instructions. The opcode for those instructions is 1A because the 8 in the heading is replaced by the number to the right of the backslash in the Offset column. The instruction format is listed under the instruction symbol.

Table A–8 Opcode Summary

Offset	00	08	10	18	20	28	30	38
0/8	PAL* (pal)	LDA (mem)	INTA* (op)	MISC* (mem)	LDF (mem)	LDL (mem)	BR (br)	BLBC (br)
1/9	Res	LDAH (mem)	INTL* (op)	\PAL\ (mem)	LDG (mem)	LDQ (mem)	FBEQ (br)	BEQ (br)
2/A	LDBU	Res	INTS* (op)	JSR* (mem)	LDS (mem)	LDL_L (mem)	FBLT (br)	BLT (br)

Table A–8 Opcode Summary (Continued)

Offset	00	08	10	18	20	28	30	38
3/B	Res	LDQ_U (mem)	INTM* (op)	\PAL\	LDT (mem)	LDQ_L (mem)	FBLE (br)	BLE (br)
4/C	LDWU	Res	ITFP*	FPTI*	STF (mem)	STL (mem)	BSR (br)	BLBS (br)
5/D	Res	STW	FLTV* (op)	\PAL\	STG (mem)	STQ (mem)	FBNE (br)	BNE (br)
6/E	Res	STB	FLTI* (op)	\PAL\	STS (mem)	STL_C (mem)	FBGE (br)	BGE (br)
7/F	Res	STQ_U (mem)	FLTL* (op)	\PAL\	STT (mem)	STQ_C (mem)	FBGT (br)	BGT (br)

Table A–9 explains the symbols used in Table A–8.

Table A–9 Key to Opcode Summary Used in Table A–8

Symbol	Meaning
FLTI*	IEEE floating-point instruction opcodes
FLTL*	Floating-point operate instruction opcodes
FLTV*	VAX floating-point instruction opcodes
FPTI*	Floating-point to integer register move opcodes
INTA*	Integer arithmetic instruction opcodes
INTL*	Integer logical instruction opcodes
INTM*	Integer multiply instruction opcodes
INTS*	Integer shift instruction opcodes
ITFP*	Integer to floating-point register move opcodes
JSR*	Jump instruction opcodes
MISC*	Miscellaneous instruction opcodes
PAL*	PALcode instruction (CALL_PAL) opcodes
\PAL\	Reserved for PALcode
Res	Reserved for Compaq

A.7 Required PALcode Function Codes

Table A–10 lists opcodes required for all Alpha implementations. The notation used is *oo.ffff*, where *oo* is the hexadecimal 6-bit opcode and *ffff* is the hexadecimal 26-bit function code.

Table A–10 Required PALcode Function Codes

Mnemonic	Type	Function Code
DRAINA	Privileged	00.0002
HALT	Privileged	00.0000
IMB	Unprivileged	00.0086

A.8 IEEE Floating-Point Conformance

The 21264/EV68A supports the IEEE floating-point operations defined in the *Alpha System Reference Manual, Revision 8* and therefore also from the *Alpha Architecture Reference Manual, Fourth Edition*. Support for a complete implementation of the IEEE Standard for Binary Floating-Point Arithmetic (ANSI/IEEE Standard 754 1985) is provided by a combination of hardware and software. The 21264/EV68A provides several hardware features to facilitate complete support of the IEEE standard.

The 21264/EV68A provides the following hardware features to facilitate complete support of the IEEE standard:

- The 21264/EV68A implements precise exception handling in hardware, as denoted by the AMASK instruction returning bit 9 set. TRAPB instructions are treated as NOPs and are not issued.
- The 21264/EV68A accepts both Signaling and Quiet NaNs as input operands and propagates them as specified by the Alpha architecture. In addition, the 21264/EV68A delivers a canonical Quiet NaN when an operation is required to produce a NaN value and none of its inputs are NaNs. Encodings for Signaling NaN and Quiet NaN are defined by the *Alpha Architecture Reference Manual, Fourth Edition*.
- The 21264/EV68A accepts infinity operands and implements infinity arithmetic as defined by the IEEE standard and the *Alpha Architecture Reference Manual, Fourth Edition*.
- The 21264/EV68A implements SQRT for single (SQRTS) and double (SQRTT) precision in hardware.

Note: In addition, the 21264/EV68A also implements the VAX SQRTF and SQRTG instructions.

- The 21264/EV68A implements the FPCR[DNZ] bit. When FPCR[DNZ] is set, denormal input operand traps can be avoided for arithmetic operations that include the /S qualifier. When FPCR[DNZ] is clear, denormal input operands for arithmetic operations produce an unmaskable denormal trap. CPYSE/CPYSN, FCMOV_{xx}, and MF_FPCR/MT_FPCR are not arithmetic operations, and pass denormal values without initiating arithmetic traps.
- The 21264/EV68A implements the following disable bits in the floating-point control register (FPCR):
 - Underflow disable (UNFD)
 - Overflow disable (OVFD)
 - Inexact result disable (INED)
 - Division by zero disable (DZED)
 - Invalid operation disable (INVD)

If one of these bits is set, and an instruction with the /S qualifier set generates the associated exception, the 21264/EV68A produces the IEEE nontrapping result and suppresses the trap. These nontrapping responses include correctly signed infinity, largest finite number, and Quiet NaNs as specified by the IEEE standard.

The 21264/EV68A does not produce a denormal result for the underflow exception. Instead, a true zero (+0) is written to the destination register. In the 21264/EV68A, the FPCR underflow to zero (UNDZ) bit must be set if the underflow disable (UNFD) bit is set. If desired, trapping on underflow can be enabled by the instruction and the FPCR, and software may compute the denormal value as defined in the IEEE standard.

The 21264/EV68A records floating-point exception information in two places:

- The FPCR status bits record the occurrence of all exceptions that are detected, whether or not the corresponding trap is enabled. The status bits are cleared only through an explicit clear command (MT_FPCR); hence, the exception information they record is a summary of all exceptions that have occurred since the last time they were cleared.
- If an exception is detected and the corresponding trap is enabled by the instruction, and is not disabled by the FPCR control bits, the 21264/EV68A will record the condition in the EXC_SUM register and initiate an arithmetic trap.

The following items apply to Table A–11:

- The 21264/EV68A traps on a denormal input operand for all arithmetic operations unless FPCR[DNZ] = 1.
- Input operand traps take precedence over arithmetic result traps.
- The following abbreviations are used:

Inf: Infinity

QNaN: Quiet NaN

SNaN: Signalling NaN

CQNaN: Canonical Quiet NaN

For IEEE instructions with /S, Table A–11 lists all exceptional input and output conditions recognized by the 21264/EV68A, along with the result and exception generated for each condition.

Table A–11 Exceptional Input and Output Conditions

Alpha Instructions	21264/EV68A Hardware Supplied Result	Exception
ADDx SUBx INPUT		
Inf operand	\pm Inf	(none)
QNaN operand	QNaN	(none)
SNaN operand	QNaN	Invalid Op
Effective subtract of two Inf operands	CQNaN	Invalid Op
ADDx SUBx OUTPUT		

Table A–11 Exceptional Input and Output Conditions (Continued)

Alpha Instructions	21264/EV68A Hardware Supplied Result	Exception
Exponent overflow	$\pm\text{Inf}$ or $\pm\text{MAX}$	Overflow
Exponent underflow	+0	Underflow
Inexact result	Result	Inexact

Table A–11 Exceptional Input and Output Conditions (Continued)

Alpha Instructions	21264/EV68A Hardware Supplied Result	Exception
MUL_x INPUT		
Inf operand	±Inf	(none)
QNaN operand	QNaN	(none)
SNaN operand	QNaN	Invalid Op
0 * Inf	CQNaN	Invalid Op
MUL_x OUTPUT (same as ADD_x)		
DIV_x INPUT		
QNaN operand	QNaN	(none)
SNaN operand	QNaN	Invalid Op
0/0 or Inf/Inf	CQNaN	Invalid Op
A/0 (A not 0)	±Inf	Div Zero
A/Inf	±0	(none)
Inf/A	±Inf	(none)
DIV_x OUTPUT (same as ADD_x)		
SQRT_x INPUT		
+Inf operand	+Inf	(none)
QNaN operand	QNaN	(none)
SNaN operand	QNaN	Invalid Op
-A (A not 0)	CQNaN	Invalid Op
-0	-0	(none)
SQRT_x OUTPUT		
Inexact result	root	Inexact
CMPTEQ CMPTUN INPUT		
Inf operand	True or False	(none)
QNaN operand	False for EQ, True for UN	(none)
SNaN operand	False for EQ, True for UN	Invalid Op
CMPTLT CMPTLE INPUT		
Inf operand	True or False	(none)
QNaN operand	False	Invalid Op
SNaN operand	False	Invalid Op
CVT_{fi} INPUT		
Inf operand	0	Invalid Op
QNaN operand	0	Invalid Op

Table A–11 Exceptional Input and Output Conditions (Continued)

Alpha Instructions	21264/EV68A Hardware Supplied Result	Exception
SNaN operand	0	Invalid Op
CVTfi OUTPUT		
Inexact result	Result	Inexact
Integer overflow	Truncated result	Invalid Op
CVTif OUTPUT		
Inexact result	Result	Inexact
CVTff INPUT		
Inf operand	\pm Inf	(none)
QNaN operand	QNaN	(none)
SNaN operand	QNaN	Invalid Op
CVTff OUTPUT (same as ADDx)		
FBEQ FBNE FBLT FBLE FBGT FBGE LDS LDT STS STT CPYS CPYSN FCMOV _x		

See Section 2.14 for information about the floating-point control register (FPCR).

21264/EV68A Boundary-Scan Register

This appendix contains the BSDL description of the 21264/EV68A boundary-scan register.

B.1 Boundary-Scan Register

The Boundary-Scan Register (BSR) on the 21264/EV68A is 367 bits long. It is accessed by the three public (SAMPLE, EXTEST, CLAMP) instructions. The register operation for the public instructions is compliant with the IEEE 1149.1 standard.

The boundary-scan register covers all input, output, and bidirectional pins with the exception of the compliance enable pins and pins that are power-supply-type or analog in nature. The BSDL for the boundary-scan register is given in Section B.1.1.

B.1.1 BSDL Description of the Alpha 21264/EV68A Boundary-Scan Register

```

-----
-- alpha21264b.bsd1
--The BSDL Description for EV6's IEEE 1149.1 Circuits
-----
-- Revision History
--Rev Date Description
-- 1.0 Feb 99 First external release
-----

entity Alpha_21264b is-- (ref B.8)
  generic (PHYSICAL_PIN_MAP :string := "PGA_EV6");-- (ref B.8.2)
  port (-- (ref B.8.3)
    TestStat_H          :out    bit          ;
    SromOE_L            :out    bit          ;
    SromClk_H           :out    bit          ;
    SromData_H          :in     bit          ;
    Reset_L             :in     bit          ;
    IRQ_H               :in     bit_vector (0 to 5) ;
    DcOk_H              :linkage bit          ; -- Compliance enable input
    NoConnect_0         :linkage bit          ; -- n/c
    NoConnect_1         :linkage bit          ; -- n/c
    PllBypass_H         :linkage bit          ;
    FrameClk_H          :linkage bit          ;
    FrameClk_L          :linkage bit          ;
    ClkFwdRst_H        :in     bit          ;
    BcCheck_H           :inout  bit_vector (0 to 15);
    BcData_H            :inout  bit_vector (0 to 127);
    SysData_L           :inout  bit_vector (0 to 63) ;
    SysCheck_L          :inout  bit_vector (0 to 7) ;
    BcDataInClk_H       :in     bit_vector (0 to 7) ;
    SysDataOutClk_L    :out    bit_vector (0 to 7) ;
    Spare_7             :linkage bit_vector (0 to 7) ;
  );
end entity Alpha_21264b;

```

Boundary-Scan Register

```

SysDataInClk_H      :in      bit_vector (0 to 7) ;
BcDataOutClk_L     :out      bit_vector (0 to 3) ; -- JWB corrected
BcDataOutClk_H     :out      bit_vector (0 to 3) ; -- JWB corrected
ClkIn_H            :linkage bit           ; -- Oscillator
ClkIn_L            :linkage bit           ; -- Oscillator
PLL_VDD            :linkage bit           ;
EV6Clk_H           :linkage bit           ;
EV6Clk_L           :linkage bit           ;
Spare_4             :linkage bit           ;
Spare_5             :linkage bit           ;
BcTag_H             :inout   bit_vector (20 to 42);
BcVref              :linkage bit           ;
BcTagInClk_H       :in      bit           ; -- Name in model:
BcTagClkIn_H
BcTagParity_H      :inout   bit           ;
BcTagShared_H      :inout   bit           ;
BcTagDirty_H       :inout   bit           ;
BcTagValid_H       :inout   bit           ;
BcTagOutClk_L      :out      bit           ;
BcTagOutClk_H      :out      bit           ;
BcTagOE_L          :out      bit           ;
BcTagWr_L          :out      bit           ;
BcDataWr_L         :out      bit           ;
BcLoad_L           :out      bit           ;
BcDataOE_L         :out      bit           ;
BcAdd_H            :out      bit_vector (4 to 23) ;
SysAddOut_L        :out      bit_vector (0 to 14) ;
SysAddIn_L         :in      bit_vector (0 to 14) ;
SysAddInClk_L      :in      bit           ;
SysAddOutClk_L     :out      bit           ; --JWB added
SysVref            :linkage bit           ; --JWB added
SysFillValid_L    :in      bit           ;
SysDataInValid_L  :in      bit           ;
SysDataOutValid_L :in      bit           ;
Spare_0            :linkage bit           ; -- n/c
MiscVref           :linkage bit           ; --
Spare_2            :linkage bit           ; -- n/c
Tdi_H              :in      bit           ;
Tdo_H              :out      bit           ;
Trst_L             :in      bit           ;
Tck_H              :in      bit           ;
Tms_H              :in      bit           ;
VSS:linkage bit_vector (0 to 103);
VDD :linkage bit_vector (0 to 93) );

use STD_1149_1_1994.all ;-- (ref B.8.4)

attribute COMPONENT_CONFORMANCE of Alpha_21264: entity is "STD_1149_1_1993";
attribute PIN_MAP of Alpha_21264 : entity is PHYSICAL_PIN_MAP ;

constant PGA_EV6 : PIN_MAP_STRING := "
"SysAddIn_L      : (BD30, BC29, AY28, BE29, AW27, BA27, BD28, BE27, "&
"
AY26, BC25, BB24, AV24, BD24, BE23, AW23), "&
"SysAddInClk_L   : BB26, "&
"SysVref         : BA25, "&
"SysFillValid_L : BC23, "&
"SysAddOut_L     : (AW33, BE39, BD36, BC35, BA33, AY32, BE35, AV30, "&
"
BB32, BA31, BE33, AW29, BC31, AV28, BB30), "&
"SysAddOutClk_L : BD34, "&
"SysData_L      : (F14 , G13 , F12 , H12 , H10 , G7 , F6 , K8 , "&
"
M6 , N7 , P6 , T8 , V8 , V6 , W7 , Y6 , "&
"
AB8 , AC7 , AD8 , AE5 , AH6 , AH8 , AJ7 , AL5 , "&
"
AP8 , AR7 , AT8 , AV6 , AV10, AW11, AV12, AW13, "&
"
F32 , F34 , H34 , H34 , G35 , F40 , G39 , K38 , J41 , "&
"
M40 , N39 , P40 , T38 , V40 , W41 , W39 , Y40 , "&
"

```

Boundary-Scan Register

```

"                AB38, AC39, AD38, AF40, AH38, AJ39, AL41, AK38, "&
"                AN39, AP38, AR39, AT38, AY38, AV36, AW35, AV34), "&
"SysCheck_L      : (L7 , AA5 , AK8 , BA13, L39 , AA41, AM40, AY34), "&
"SysDataInClk_H : (D8 , P4 , AF6 , AY6 , E37 , R43 , AG41, AV40), "&
:
"SysDataOutClk_L : (G11 , U7 , AG7 , AY8 , H36 , R41 , AH40, AW39), "&
"SysDataInvalid_L : BD22, "&
"SysDataOutValid_L : BB22, "&
"BcAdd_H         : (B28 , E27 , A29 , G27 , C29 , F28 , B30 , D30 , "&
"                C31 , H28 , G29 , A33 , E31 , D32 , B34 , A35 , "&
"                B36 , H30 , C35 , E33 ), "&
"BcDataOE_L     : A27 , "&
"BcLoad_L      : F26 , "&
"BcDataWr_L    : D26 , "&
"BcData_H      : (B10 , D10 , A5 , C5 , C3 , E3 , H6 , E1 , "&
"                J3 , K2 , L3 , M2 , T2 , U1 , V2 , Y4 , "&
"                AC1 , AD2 , AE3 , AG1 , AK2 , AL3 , AR1 , AP2 , "&
"                AY2 , BB2 , AW5 , BB4 , BB8 , BE5 , BB10, BE7 , "&
"                G33 , C37 , B40 , C41 , C43 , E43 , G41 , F44 , "&
"                K44 , N41 , M44 , P42 , U43 , V44 , Y42 , AB44 , "&
"                AD42, AE43, AF42, AJ45, AK42, AN45, AP44, AN41 , "&
"                AW45, AU41, AY44, BA43, BC43, BD42, BB38, BE41 , "&
"                C11 , A7 , C9 , B6 , B4 , D4 , G5 , D2 , "&
"                H4 , G1 , N5 , L1 , N1 , U3 , W5 , W1 , "&
"                AB2 , AC3 , AD4 , AF4 , AJ3 , AK4 , AN1 , AM4 , "&
"                AU5 , BA1 , BA3 , BC3 , BD6 , BA9 , BC9 , AY12 , "&
"                A39 , D36 , A41 , B42 , D42 , D44 , H40 , H42 , "&
"                G45 , L43 , L45 , N45 , T44 , U45 , W45 , AA43 , "&
"                AC43, AD44, AE41, AG45, AK44, AL43, AM42, AR45 , "&
"                AP40, BA45, AV42, BB44, BB42, BC41, BA37, BD40), "&
"BcCheck_H      : (F2 , AB4 , AT2 , BC11, M38 , AB42, AU43, BC37 , "&
"                M8 , AA3 , AW1 , BD10, E45 , AC45, AT44, BB36), "&
"BcDataInClk_H  : (E7 , R3 , AH2 , BC5 , F38 , U39 , AH44, AY40), "&
"Spare_7       : (F8 , T4 , AJ1 , BD4 , E39 , V38 , AJ43, BA39), "&
"BcDataOutClk_L : (K4 , AV4 , K42 , AT42), "&
"BcDataOutClk_H : (J5 , AU3 , J43 , AR43), "&
"BcTag_H       : (E13 , H16 , A11 , B12 , D14 , E15 , A13 , G17 , "&
"                C15 , H18 , D16 , B16 , C17 , A17 , E19 , B18 , "&
"                A19 , F20 , D20 , E21 , C21 , D22 , H22 ), "&
"BcTagValid_H   : B24 , "&
"BcTagDirty_H   : C23 , "&
"BcTagShared_H  : G23 , "&
"BcTagParity_H  : B22 , "&
"BcTagOE_L     : H24 , "&
"BcTagWr_L     : E25 , "&
"BcTagInClk_H  : G19 , "&
"BcVref        : F18 , "&
"BcTagOutClk_L : D24 , "&
"BcTagOutClk_H : C25 , "&
"IRQ_H         : (BA15, BE13, AW17, AV18, BC15, BB16), "&
"Reset_L      : BD16, "&
"SromData_H   : BC17, "&
"SromCLK_H    : AW19, "&
"SromOE_L     : BE17, "&
"Tms_H       : BD18, "&
"Tck_H       : BE19, "&
"Trst_L     : AY20, "&
"Tdi_H      : BA21, "&
"Tdo_H      : BB20, "&
"TestStat_H : BA19, "&
"ClkIn_H    : AM8 , "&
"ClkIn_L    : AN7 , "&
"FrameClk_H : AV16, "&
"FrameClk_L : AW15, "&
"PllBypass_H : BD12, "&

```

Boundary-Scan Register

```

"NoConnect_0          : BB14,    "&
"NoConnect_1          : BD2,     "&
"ClkFwdRst_H         : BE11,    "&
"EV6Clk_H            : AM6,     "&
"EV6Clk_L            : AL7,     "&
"Spare_4              : AT4,     "&
"Spare_5              : AR3,     "&
"PLL_VDD             : AV8,     "&
"Spare_0              : BC21,    "&
"MiscVref             : AV22,    "&
"Spare_2              : BE9,     "&
"DCOK_H              : AY18,    "&
"VSS:                 (C1, W3, AR5, G9, E17, G25, C33, AA39, "&
"                     BA41, R45, J1, AG3, BA5, AW9, BA17, AW25, "&
"                     BC33, AE39, A43, AA45, R1, AN3, C7, C19, "&
"                     BE25, E35, AL39, G43, AE45, AA1, AW3, J7, "&
"                     E11, BC19, C27, BA35, AU39, N43, AL45, AE1, "&
"                     BE3, R7, BA11, A21, BC27, A37, BC39, W43, "&
"                     AU45, AL1, E5, AA7, C13, G21, E29, G37, "&
"                     E41, AG43, BC45, AU1, L5, AE7, BC13, AW21, "&
"                     BA29, AW37, L41, AN43, BC1, U5, AU7, A15, "&
"                     BE21, A31, BE37, U41, AW43, A3, AC5, AW7, "&
"                     G15, E23, G31, C39, AC41, BE43, G3, AJ5, "&
"                     BC7, AY14, BA23, AW31, J39, AJ41, C45, N3, "&
"                     AN5, A9, BE15, A25, BE31, R39, AR41, J45, "&
"                     E9, R5, AG5, BA7, D38, T42, AG39, AW41), "&
"VDD                  : (B2, V4, AP6, D12, B20, H26, BD32, AM38, "&
"                     BB40, Y44, H2, AH4, AT6, BB12, H20, AV26, "&
"                     D34, AV38, F42, AF44, P2, AP4, BB6, B14, "&
"                     AV20, BD26, BB34, BD38, M42, AM44, Y2, AY4, "&
"                     B8, H14, BD20, D28, F36, D40, V42, AV44, "&
"                     AF2, D6, P8, AV14, F22, BB28, AY36, K40, "&
"                     AH42, BD44, AM2, K6, Y8, BD14, AY22, F30, "&
"                     B38, T40, AP42, AV2, T6, AF8, F16, A23, "&
"                     AY30, H38, AB40, AY42, AB6, BD8, AY16, F24, "&
"                     B32, P38, AD40, B44, F4, AD6, F10, D18, "&
"                     AY24, H32, Y38, AK40, H44, M4, AK6, AY10, "&
"                     BB18, B26, AV32, AF38, AT40, P44 ) ";

constant numeric_EV6 : PIN_MAP_STRING := " "&
"SysAddIn_L          : (559, 536, 468, 580, 445, 490, 558, 579, "&
"                     467, 534, 511, 421, 556, 577, 443 ), "&
"SysAddInClk_L       : 512, "&
"SysVref              : 489, "&
"SysFillValid_L      : 533, "&
"SysAddOut_L         : (448, 585, 562, 539, 493, 470, 583, 424, "&
"                     515, 492, 582, 446, 537, 423, 514 ), "&
"SysAddOutClk_L      : 561, "&
"SysData_L           : (118, 140, 117, 161, 160, 137, 114, 189, "&
"                     204, 213, 220, 237, 253, 252, 261, 268, "&
"                     285, 293, 301, 308, 332, 333, 341, 356, "&
"                     381, 389, 397, 412, 414, 437, 415, 438, "&
"                     127, 128, 172, 151, 131, 153, 190, 183, "&
"                     207, 214, 223, 238, 255, 263, 262, 271, "&
"                     286, 294, 302, 319, 334, 342, 359, 350, "&
"                     374, 382, 390, 398, 473, 427, 449, 426 ), "&
"SysCheck_L          : (197, 276, 349, 483, 198, 279, 367, 471 ), "&
"SysDataInClk_H      : (70, 219, 316, 457, 107, 232, 327, 429 ), "&
"SysDataOutClk_L     : (139, 245, 325, 458, 173, 231, 335, 451 ), "&
"SysDataInvalid_L    : 555, "&
"SysDataOutValid_L   : 510, "&
"BcAdd_H             : (35, 102, 14, 147, 58, 125, 36, 81, "&
"                     59, 169, 148, 16, 104, 82, 38, 17, "&
"                     39, 170, 61, 105 ), "&
"BcDataOE_L          : 13, "&

```

Boundary-Scan Register

```

"BcLoad_L                : 124 ,                                "&
"BcDataWr_L              : 79 ,                                "&
"BcData_H                : ( 26 , 71 , 2 , 46 , 45 , 90 , 159 , 89 , "&
"                          179 , 186 , 195 , 202 , 234 , 242 , 250 , 267 , "&
"                          290 , 298 , 307 , 322 , 346 , 355 , 386 , 378 , "&
"                          455 , 500 , 434 , 501 , 503 , 568 , 504 , 569 , "&
"                          150 , 62 , 41 , 64 , 65 , 110 , 154 , 133 , "&
"                          193 , 215 , 209 , 224 , 248 , 257 , 272 , 289 , "&
"                          304 , 312 , 320 , 345 , 352 , 377 , 385 , 375 , "&
"                          454 , 407 , 476 , 498 , 543 , 565 , 518 , 586 , "&
"                          49 , 3 , 48 , 24 , 23 , 68 , 136 , 67 , "&
"                          158 , 134 , 212 , 194 , 210 , 243 , 260 , 258 , "&
"                          282 , 291 , 299 , 315 , 339 , 347 , 370 , 363 , "&
"                          404 , 477 , 478 , 523 , 547 , 481 , 526 , 460 , "&
"                          19 , 84 , 20 , 42 , 87 , 88 , 175 , 176 , "&
"                          156 , 200 , 201 , 217 , 241 , 249 , 265 , 280 , "&
"                          296 , 305 , 311 , 329 , 353 , 360 , 368 , 393 , "&
"                          383 , 499 , 430 , 521 , 520 , 542 , 495 , 564 ) , "&
"BcCheck_H               : ( 112 , 283 , 394 , 527 , 206 , 288 , 408 , 540 , "&
"                          205 , 275 , 432 , 549 , 111 , 297 , 401 , 517 ) , "&
"BcDataInClk_H           : ( 92 , 227 , 330 , 524 , 130 , 246 , 337 , 474 ) , "&
"Spare_7                 : ( 115 , 235 , 338 , 546 , 108 , 254 , 344 , 496 ) , "&
"BcDataOutClk_L          : ( 187 , 411 , 192 , 400 ) ,                                "&
"BcDataOutClk_H          : ( 180 , 403 , 184 , 392 ) ,                                "&
"BcTag_H                 : ( 95 , 163 , 5 , 27 , 73 , 96 , 6 , 142 , "&
"                          51 , 164 , 74 , 29 , 52 , 8 , 98 , 30 , "&
"                          9 , 121 , 76 , 99 , 54 , 77 , 166 ) ,                                "&
"BcTagValid_H            : 33 ,                                "&
"BcTagDirty_H            : 55 ,                                "&
"BcTagShared_H           : 145 ,                                "&
"BcTagParity_H           : 32 ,                                "&
"BcTagOE_L               : 167 ,                                "&
"BcTagWr_L               : 101 ,                                "&
"BcTagInClk_H            : 143 ,                                "&
"BcVref                  : 120 ,                                "&
"BcTagOutClk_L           : 78 ,                                "&
"BcTagOutClk_H           : 56 ,                                "&
"IRQ_H                   : ( 484 , 572 , 440 , 418 , 529 , 507 ) ,                                "&
"Reset_L                 : 552 ,                                "&
"SromData_H              : 530 ,                                "&
"SromCLK_H               : 441 ,                                "&
"SromOE_L                : 574 ,                                "&
"Tms_H                   : 553 ,                                "&
"Tck_H                   : 575 ,                                "&
"Trst_L                  : 464 ,                                "&
"Tdi_H                   : 487 ,                                "&
"Tdo_H                   : 509 ,                                "&
"TestStat_H              : 486 ,                                "&
"ClkIn_H                 : 365 ,                                "&
"ClkIn_L                 : 373 ,                                "&
"FrameClk_H              : 417 ,                                "&
"FrameClk_L              : 439 ,                                "&
"Pl1Bypass_H            : 550 ,                                "&
"NoConnect_0             : 506 ,                                "&
"NoConnect_1             : 545 ,                                "&
"ClkFwdRst_H            : 571 ,                                "&
"EV6Clk_H               : 364 ,                                "&
"EV6Clk_L               : 357 ,                                "&
"Spare_4                 : 395 ,                                "&
"Spare_5                 : 387 ,                                "&
"PLL_VDD                 : 413 ,                                "&
"Spare_0                 : 532 ,                                "&
"MiscVref                : 420 ,                                "&
"Spare_2                 : 570 ,                                "&
"DCOK_H                  : 463 ,                                "&

```

Boundary-Scan Register

```

"VSS                                : (44 , 259 , 388 , 138 , 97 , 146 , 60 , 278 , "&
"                                  497 , 233 , 178 , 323 , 479 , 436 , 485 , 444 , "&
"                                  538 , 310 , 21 , 281 , 226 , 371 , 47 , 53 , "&
"                                  578 , 106 , 358 , 155 , 313 , 274 , 433 , 181 , "&
"                                  94 , 531 , 57 , 494 , 406 , 216 , 361 , 306 , "&
"                                  567 , 229 , 482 , 10 , 535 , 18 , 541 , 264 , "&
"                                  409 , 354 , 91 , 277 , 50 , 144 , 103 , 152 , "&
"                                  109 , 328 , 544 , 402 , 196 , 309 , 528 , 442 , "&
"                                  491 , 450 , 199 , 376 , 522 , 244 , 405 , 7 , "&
"                                  576 , 15 , 584 , 247 , 453 , 1 , 292 , 435 , "&
"                                  141 , 100 , 149 , 63 , 295 , 587 , 135 , 340 , "&
"                                  525 , 461 , 488 , 447 , 182 , 343 , 66 , 211 , "&
"                                  372 , 4 , 573 , 12 , 581 , 230 , 391 , 185 , "&
"                                  93 , 228 , 324 , 480 , 85 , 240 , 326 , 452 ) "&
"VDD                                : (22 , 251 , 380 , 72 , 31 , 168 , 560 , 366 , "&
"                                  519 , 273 , 157 , 331 , 396 , 505 , 165 , 422 , "&
"                                  83 , 428 , 132 , 321 , 218 , 379 , 502 , 28 , "&
"                                  419 , 557 , 516 , 563 , 208 , 369 , 266 , 456 , "&
"                                  25 , 162 , 554 , 80 , 129 , 86 , 256 , 431 , "&
"                                  314 , 69 , 221 , 416 , 122 , 513 , 472 , 191 , "&
"                                  336 , 566 , 362 , 188 , 269 , 551 , 465 , 126 , "&
"                                  40 , 239 , 384 , 410 , 236 , 317 , 119 , 11 , "&
"                                  469 , 174 , 287 , 475 , 284 , 548 , 462 , 123 , "&
"                                  37 , 222 , 303 , 43 , 113 , 300 , 116 , 75 , "&
"                                  466 , 171 , 270 , 351 , 177 , 203 , 348 , 459 , "&
"                                  508 , 34 , 425 , 318 , 399 , 225 )          ";

```

```

attribute PORT_GROUPING of Alpha_21264b : entity is-- (Ref B.8.8. See Note 4.
"Differential_Voltage ( (CLKIN_H), (CLKIN_L) )" ;

```

```

attribute TAP_SCAN_CLOCK of Tck_H : signal is (5.0e6, LOW);
attribute TAP_SCAN_IN of Tdi_H : signal is TRUE;
attribute TAP_SCAN_OUT of Tdo_H : signal is TRUE;
attribute TAP_SCAN_MODE of Tms_H : signal is TRUE;
attribute TAP_SCAN_RESET of Trst_L : signal is TRUE;

```

```

attribute COMPLIANCE_PATTERNS of Alpha_21264b : entity is -- (Ref B.8.10). See Note 4.
"(DcOk_H), (1)" ;

```

```

attribute INSTRUCTION_LENGTH of Alpha_21264b : entity is 5 ;
attribute INSTRUCTION_OPCODE of Alpha_21264b : entity is
"EXTEST (11011),"&-- No longer mandated to be (00000)!
"SAMPLE (11000),"&-- JWB changed "PRELOAD" to "SAMPLE"
"CLAMP (11010),"&
"HIGHZ (11001),"&
"DIE_ID (11110),"&
"BYPASS (11111)";

```

```

attribute INSTRUCTION_CAPTURE of Alpha_21264b : entity is "00001" ;
attribute INSTRUCTION_PRIVATE of Alpha_21264b : entity is "Private"; -- See Note 4.

```

```

attribute REGISTER_ACCESS of Alpha_21264b : entity is-- (ref B.8.13)
"BOUNDARY (EXTEST, SAMPLE)," &-- Redundant. Added for completeness
"BYPASS (BYPASS, HIGHZ, CLAMP)," &-- ditto
"DIE_ID[32] (DIE_ID)";

```

```

attribute BOUNDARY_LENGTH of Alpha_21264b : entity is 367 ;

```

```

attribute BOUNDARY_REGISTER of Alpha_21264b : entity is

```

```

-----
-- scan cell                safe   cntrl disable disable
-- cell type port          function | cell value state
----|-----|-----|-----|-----|-----|-----|-----
" 366 ( BC_2, TestStat_H,   OUTPUT2, x                ), "& --
" 365 ( BC_2, SromOE_L,    OUTPUT2, X                ), "& --
" 364 ( BC_2, SromClk_H,   OUTPUT2, x                ), "& --

```



```

" 363 ( BC_2, SromData_H,          INPUT,    x          ), "& --
" 362 ( BC_3, reset_L,            INPUT,    x          ), "& --
" 361 ( BC_3, IRQ_H(5),           INPUT,    x          ), "& --
" 360 ( BC_3, IRQ_H(4),           INPUT,    x          ), "& --
" 359 ( BC_3, IRQ_H(3),           INPUT,    x          ), "& --
" 358 ( BC_3, IRQ_H(2),           INPUT,    x          ), "& --
" 357 ( BC_3, IRQ_H(1),           INPUT,    x          ), "& --
" 356 ( BC_3, IRQ_H(0),           INPUT,    x          ), "& --
" 355 ( BC_3, ClkFwdRst_H,        INPUT,    x          ), "& --
" 354 ( BC_2, BcCheck_H(3),       BIDIR,    x, 339, 0, Z   ), "& --
" 353 ( BC_2, BcCheck_H(11),      BIDIR,    x, 339, 0, Z   ), "& --
" 352 ( BC_2, SysCheck_L(3),      BIDIR,    x, 336, 0, WEAK1 ), "& --
" 351 ( BC_2, BcData_H(31),       BIDIR,    x, 339, 0, Z   ), "& --
" 350 ( BC_2, BcData_H(95),       BIDIR,    x, 339, 0, Z   ), "& --
" 349 ( BC_2, SysData_L(31),      BIDIR,    x, 336, 0, WEAK1 ), "& --
" 348 ( BC_2, BcData_H(30),       BIDIR,    x, 339, 0, Z   ), "& --
" 347 ( BC_2, BcData_H(94),       BIDIR,    x, 339, 0, Z   ), "& --
" 346 ( BC_2, SysData_L(30),      BIDIR,    x, 336, 0, WEAK1 ), "& --
" 345 ( BC_2, BcData_H(29),       BIDIR,    x, 339, 0, Z   ), "& --
" 344 ( BC_2, BcData_H(93),       BIDIR,    x, 339, 0, Z   ), "& --
" 343 ( BC_2, SysData_L(29),      BIDIR,    x, 336, 0, WEAK1 ), "& --
" 342 ( BC_2, BcData_H(28),       BIDIR,    x, 339, 0, Z   ), "& --
" 341 ( BC_2, BcData_H(92),       BIDIR,    x, 339, 0, Z   ), "& --
" 340 ( BC_2, SysData_L(28),      BIDIR,    x, 336, 0, WEAK1 ), "& --
" 339 ( BC_3, *,                  CONTROL,  0          ), "& -- bccell0
" 338 ( BC_3, BcDataInClk_H(3),   INPUT,    x          ), "& --
" 337 ( BC_2, SysDataOutClk_L(3), OUTPUT2,  x          ), "& --
" 336 ( BC_3, *,                  CONTROL,  0          ), "& -- sccell0
" 335 ( BC_3, SysDataInClk_H(3),  INPUT,    x          ), "& --
" 334 ( BC_2, BcData_H(27),       BIDIR,    x, 339, 0, Z   ), "& --
" 333 ( BC_2, BcData_H(91),       BIDIR,    x, 339, 0, Z   ), "& --
" 332 ( BC_2, SysData_L(27),      BIDIR,    x, 336, 0, WEAK1 ), "& --
" 331 ( BC_2, BcData_H(26),       BIDIR,    x, 339, 0, Z   ), "& --
" 330 ( BC_2, BcData_H(90),       BIDIR,    x, 339, 0, Z   ), "& --
" 329 ( BC_2, SysData_L(26),      BIDIR,    x, 336, 0, WEAK1 ), "& --
" 328 ( BC_2, BcData_H(25),       BIDIR,    x, 339, 0, Z   ), "& --
" 327 ( BC_2, BcData_H(89),       BIDIR,    x, 339, 0, Z   ), "& --
" 326 ( BC_2, SysData_L(25),      BIDIR,    x, 336, 0, WEAK1 ), "& --
" 325 ( BC_2, BcData_H(24),       BIDIR,    x, 339, 0, Z   ), "& --
" 324 ( BC_2, BcData_H(88),       BIDIR,    x, 339, 0, Z   ), "& --
" 323 ( BC_2, SysData_L(24),      BIDIR,    x, 336, 0, WEAK1 ), "& --
" 322 ( BC_2, BcDataOutClk_L(1),  OUTPUT2,  x          ), "& --
" 321 ( BC_2, BcDataOutClk_H(1),  OUTPUT2,  x          ), "& --
" 320 ( BC_2, BcCheck_H(2),       BIDIR,    x, 305, 0, Z   ), "& --
" 319 ( BC_2, BcCheck_H(10),      BIDIR,    x, 305, 0, Z   ), "& --
" 318 ( BC_2, SysCheck_L(2),      BIDIR,    x, 302, 0, WEAK1 ), "& --
" 317 ( BC_2, BcData_H(23),       BIDIR,    x, 305, 0, Z   ), "& --
" 316 ( BC_2, BcData_H(87),       BIDIR,    x, 305, 0, Z   ), "& --
" 315 ( BC_2, SysData_L(23),      BIDIR,    x, 302, 0, WEAK1 ), "& --
" 314 ( BC_2, BcData_H(22),       BIDIR,    x, 305, 0, Z   ), "& --
" 313 ( BC_2, BcData_H(86),       BIDIR,    x, 305, 0, Z   ), "& --
" 312 ( BC_2, SysData_L(22),      BIDIR,    x, 302, 0, WEAK1 ), "& --
" 311 ( BC_2, BcData_H(21),       BIDIR,    x, 305, 0, Z   ), "& --
" 310 ( BC_2, BcData_H(85),       BIDIR,    x, 305, 0, Z   ), "& --
" 309 ( BC_2, SysData_L(21),      BIDIR,    x, 302, 0, WEAK1 ), "& --
" 308 ( BC_2, BcData_H(20),       BIDIR,    x, 305, 0, Z   ), "& --
" 307 ( BC_2, BcData_H(84),       BIDIR,    x, 305, 0, Z   ), "& --
" 306 ( BC_2, SysData_L(20),      BIDIR,    x, 302, 0, WEAK1 ), "& --
" 305 ( BC_3, *,                  CONTROL,  0          ), "& -- bccell1
" 304 ( BC_3, BcDataInClk_H(2),   INPUT,    x          ), "& --
" 303 ( BC_2, SysDataOutClk_L(2), OUTPUT2,  x          ), "& --
" 302 ( BC_3, *,                  CONTROL,  0          ), "& -- sccell1
" 301 ( BC_3, SysDataInClk_H(2),  INPUT,    x          ), "& --
" 300 ( BC_2, BcData_H(19),       BIDIR,    x, 305, 0, Z   ), "& --
" 299 ( BC_2, BcData_H(83),       BIDIR,    x, 305, 0, Z   ), "& --

```

Boundary-Scan Register

```

" 298 ( BC_2, SysData_L(19),      BIDIR,    x, 302, 0, WEAK1 ), "& --
" 297 ( BC_2, BcData_H(18),      BIDIR,    x, 305, 0, Z      ), "& --
" 296 ( BC_2, BcData_H(82),      BIDIR,    x, 305, 0, Z      ), "& --
" 295 ( BC_2, SysData_L(18),     BIDIR,    x, 302, 0, WEAK1 ), "& --
" 294 ( BC_2, BcData_H(17),      BIDIR,    x, 305, 0, Z      ), "& --
" 293 ( BC_2, BcData_H(81),      BIDIR,    x, 305, 0, Z      ), "& --
" 292 ( BC_2, SysData_L(17),     BIDIR,    x, 302, 0, WEAK1 ), "& --
" 291 ( BC_2, BcData_H(16),      BIDIR,    x, 305, 0, Z      ), "& --
" 290 ( BC_2, BcData_H(80),      BIDIR,    x, 305, 0, Z      ), "& --
" 289 ( BC_2, SysData_L(16),     BIDIR,    x, 302, 0, WEAK1 ), "& --
" 288 ( BC_2, BcCheck_H(1),      BIDIR,    x, 273, 0, Z      ), "& --
" 287 ( BC_2, BcCheck_H(9),      BIDIR,    x, 273, 0, Z      ), "& --
" 286 ( BC_2, SysCheck_L(1),     BIDIR,    x, 270, 0, WEAK1 ), "& --
" 285 ( BC_2, BcData_H(15),      BIDIR,    x, 273, 0, Z      ), "& --
" 284 ( BC_2, BcData_H(79),      BIDIR,    x, 273, 0, Z      ), "& --
" 283 ( BC_2, SysData_L(15),     BIDIR,    x, 270, 0, WEAK1 ), "& --
" 282 ( BC_2, BcData_H(14),      BIDIR,    x, 273, 0, Z      ), "& --
" 281 ( BC_2, BcData_H(78),      BIDIR,    x, 273, 0, Z      ), "& --
" 280 ( BC_2, SysData_L(14),     BIDIR,    x, 270, 0, WEAK1 ), "& --
" 279 ( BC_2, BcData_H(13),      BIDIR,    x, 273, 0, Z      ), "& --
" 278 ( BC_2, BcData_H(77),      BIDIR,    x, 273, 0, Z      ), "& --
" 277 ( BC_2, SysData_L(13),     BIDIR,    x, 270, 0, WEAK1 ), "& --
" 276 ( BC_2, BcData_H(12),      BIDIR,    x, 273, 0, Z      ), "& --
" 275 ( BC_2, BcData_H(76),      BIDIR,    x, 273, 0, Z      ), "& --
" 274 ( BC_2, SysData_L(12),     BIDIR,    x, 270, 0, WEAK1 ), "& --
" 273 ( BC_3, *,                  CONTROL,  0,                ), "& -- bccell12
" 272 ( BC_3, BcDataInClk_H(1),  INPUT,    x,                ), "& --
" 271 ( BC_2, SysDataOutClk_L(1), OUTPUT2,  x,                ), "& --
" 270 ( BC_3, *,                  CONTROL,  0,                ), "& -- sccell12
" 269 ( BC_3, SysDataInClk_H(1), INPUT,    x,                ), "& --
" 268 ( BC_2, BcData_H(11),      BIDIR,    x, 273, 0, Z      ), "& --
" 267 ( BC_2, BcData_H(75),      BIDIR,    x, 273, 0, Z      ), "& --
" 266 ( BC_2, SysData_L(11),     BIDIR,    x, 270, 0, WEAK1 ), "& --
" 265 ( BC_2, BcData_H(10),      BIDIR,    x, 273, 0, Z      ), "& --
" 264 ( BC_2, BcData_H(74),      BIDIR,    x, 273, 0, Z      ), "& --
" 263 ( BC_2, SysData_L(10),     BIDIR,    x, 270, 0, WEAK1 ), "& --
" 262 ( BC_2, BcData_H(9),       BIDIR,    x, 273, 0, Z      ), "& --
" 261 ( BC_2, BcData_H(73),      BIDIR,    x, 273, 0, Z      ), "& --
" 260 ( BC_2, SysData_L(9),      BIDIR,    x, 270, 0, WEAK1 ), "& --
" 259 ( BC_2, BcData_H(8),       BIDIR,    x, 273, 0, Z      ), "& --
" 258 ( BC_2, BcData_H(72),      BIDIR,    x, 273, 0, Z      ), "& --
" 257 ( BC_2, SysData_L(8),      BIDIR,    x, 270, 0, WEAK1 ), "& --
" 256 ( BC_2, BcDataOutClk_L(0), OUTPUT2,  x,                ), "& --
" 255 ( BC_2, BcDataOutClk_H(0), OUTPUT2,  x,                ), "& --
" 254 ( BC_2, BcCheck_H(0),      BIDIR,    x, 239, 0, Z      ), "& --
" 253 ( BC_2, BcCheck_H(8),      BIDIR,    x, 239, 0, Z      ), "& --
" 252 ( BC_2, SysCheck_L(0),     BIDIR,    x, 236, 0, WEAK1 ), "& --
" 251 ( BC_2, BcData_H(7),       BIDIR,    x, 239, 0, Z      ), "& --
" 250 ( BC_2, BcData_H(71),      BIDIR,    x, 239, 0, Z      ), "& --
" 249 ( BC_2, SysData_L(7),      BIDIR,    x, 236, 0, WEAK1 ), "& --
" 248 ( BC_2, BcData_H(6),       BIDIR,    x, 239, 0, Z      ), "& --
" 247 ( BC_2, BcData_H(70),      BIDIR,    x, 239, 0, Z      ), "& --
" 246 ( BC_2, SysData_L(6),      BIDIR,    x, 236, 0, WEAK1 ), "& --
" 245 ( BC_2, BcData_H(5),       BIDIR,    x, 239, 0, Z      ), "& --
" 244 ( BC_2, BcData_H(69),      BIDIR,    x, 239, 0, Z      ), "& --
" 243 ( BC_2, SysData_L(5),      BIDIR,    x, 236, 0, WEAK1 ), "& --
" 242 ( BC_2, BcData_H(4),       BIDIR,    x, 239, 0, Z      ), "& --
" 241 ( BC_2, BcData_H(68),      BIDIR,    x, 239, 0, Z      ), "& --
" 240 ( BC_2, SysData_L(4),      BIDIR,    x, 236, 0, WEAK1 ), "& --
" 239 ( BC_3, *,                  CONTROL,  0,                ), "& -- bccell13
" 238 ( BC_3, BcDataInClk_H(0),  INPUT,    x,                ), "& --
" 237 ( BC_2, SysDataOutClk_L(0), OUTPUT2,  x,                ), "& --
" 236 ( BC_3, *,                  CONTROL,  0,                ), "& -- sccell13
" 235 ( BC_3, SysDataInClk_H(0), INPUT,    x,                ), "& --
" 234 ( BC_2, BcData_H(3),       BIDIR,    x, 239, 0, Z      ), "& --

```

Boundary-Scan Register

```

" 233 ( BC_2, BcData_H(67),          BIDIR,    x, 239, 0,    Z    ), "& --
" 232 ( BC_2, SysData_L(3),          BIDIR,    x, 236, 0,    WEAK1 ), "& --
" 231 ( BC_2, BcData_H(2),           BIDIR,    x, 239, 0,    Z    ), "& --
" 230 ( BC_2, BcData_H(66),          BIDIR,    x, 239, 0,    Z    ), "& --
" 229 ( BC_2, SysData_L(2),          BIDIR,    x, 236, 0,    WEAK1 ), "& --
" 228 ( BC_2, BcData_H(1),           BIDIR,    x, 239, 0,    Z    ), "& --
" 227 ( BC_2, BcData_H(65),          BIDIR,    x, 239, 0,    Z    ), "& --
" 226 ( BC_2, SysData_L(1),          BIDIR,    x, 236, 0,    WEAK1 ), "& --
" 225 ( BC_2, BcData_H(0),           BIDIR,    x, 239, 0,    Z    ), "& --
" 224 ( BC_2, BcData_H(64),          BIDIR,    x, 239, 0,    Z    ), "& --
" 223 ( BC_2, SysData_L(0),          BIDIR,    x, 236, 0,    WEAK1 ), "& --
" 222 ( BC_2, BcTag_H(20),           BIDIR,    x, 208, 0,    Z    ), "& --
" 221 ( BC_2, BcTag_H(21),           BIDIR,    x, 208, 0,    Z    ), "& --
" 220 ( BC_2, BcTag_H(22),           BIDIR,    x, 208, 0,    Z    ), "& --
" 219 ( BC_2, BcTag_H(23),           BIDIR,    x, 208, 0,    Z    ), "& --
" 218 ( BC_2, BcTag_H(24),           BIDIR,    x, 208, 0,    Z    ), "& --
" 217 ( BC_2, BcTag_H(25),           BIDIR,    x, 208, 0,    Z    ), "& --
" 216 ( BC_2, BcTag_H(26),           BIDIR,    x, 208, 0,    Z    ), "& --
" 215 ( BC_2, BcTag_H(27),           BIDIR,    x, 208, 0,    Z    ), "& --
" 214 ( BC_2, BcTag_H(28),           BIDIR,    x, 208, 0,    Z    ), "& --
" 213 ( BC_2, BcTag_H(29),           BIDIR,    x, 208, 0,    Z    ), "& --
" 212 ( BC_2, BcTag_H(30),           BIDIR,    x, 208, 0,    Z    ), "& --
" 211 ( BC_2, BcTag_H(31),           BIDIR,    x, 208, 0,    Z    ), "& --
" 210 ( BC_2, BcTag_H(32),           BIDIR,    x, 208, 0,    Z    ), "& --
" 209 ( BC_2, BcTag_H(33),           BIDIR,    x, 208, 0,    Z    ), "& --
" 208 ( BC_3, *,                     CONTROL,  0                    ), "& -- tccell10
" 207 ( BC_3, BcTagInClk_H,           INPUT,    x                    ), "& --
" 206 ( BC_2, BcTag_H(34),           BIDIR,    x, 208, 0,    Z    ), "& --
" 205 ( BC_2, BcTag_H(35),           BIDIR,    x, 208, 0,    Z    ), "& --
" 204 ( BC_2, BcTag_H(36),           BIDIR,    x, 208, 0,    Z    ), "& --
" 203 ( BC_2, BcTag_H(37),           BIDIR,    x, 208, 0,    Z    ), "& --
" 202 ( BC_2, BcTag_H(38),           BIDIR,    x, 208, 0,    Z    ), "& --
" 201 ( BC_2, BcTag_H(39),           BIDIR,    x, 208, 0,    Z    ), "& --
" 200 ( BC_2, BcTag_H(40),           BIDIR,    x, 208, 0,    Z    ), "& --
" 199 ( BC_2, BcTag_H(41),           BIDIR,    x, 208, 0,    Z    ), "& --
" 198 ( BC_2, BcTag_H(42),           BIDIR,    x, 208, 0,    Z    ), "& --
" 197 ( BC_2, BcTagParity_H,         BIDIR,    x, 208, 0,    Z    ), "& --
" 196 ( BC_2, BcTagShared_H,         BIDIR,    x, 208, 0,    Z    ), "& --
" 195 ( BC_2, BcTagDirty_H,          BIDIR,    x, 208, 0,    Z    ), "& --
" 194 ( BC_2, BcTagValid_H,          BIDIR,    x, 208, 0,    Z    ), "& --
" 193 ( BC_2, BcTagOutClk_L,         OUTPUT2,  x                    ), "& --
" 192 ( BC_2, BcTagOutClk_H,         OUTPUT2,  x                    ), "& --
" 191 ( BC_2, BcTagOE_L,              OUTPUT2,  x                    ), "& --
" 190 ( BC_2, BcTagWr_L,              OUTPUT2,  x                    ), "& --
" 189 ( BC_2, BcDataWr_L,            OUTPUT2,  x                    ), "& --
" 188 ( BC_2, BcLoad_L,              OUTPUT2,  x                    ), "& --
" 187 ( BC_2, BcDataOE_L,            OUTPUT2,  x                    ), "& --
" 186 ( BC_2, BcAdd_H(4),            OUTPUT2,  x                    ), "& --
" 185 ( BC_2, BcAdd_H(5),            OUTPUT2,  x                    ), "& --
" 184 ( BC_2, BcAdd_H(6),            OUTPUT2,  x                    ), "& --
" 183 ( BC_2, BcAdd_H(7),            OUTPUT2,  x                    ), "& --
" 182 ( BC_2, BcAdd_H(8),            OUTPUT2,  x                    ), "& --
" 181 ( BC_2, BcAdd_H(9),            OUTPUT2,  x                    ), "& --
" 180 ( BC_2, BcAdd_H(10),           OUTPUT2,  x                    ), "& --
" 179 ( BC_2, BcAdd_H(11),           OUTPUT2,  x                    ), "& --
" 178 ( BC_2, BcAdd_H(12),           OUTPUT2,  x                    ), "& --
" 177 ( BC_2, BcAdd_H(13),           OUTPUT2,  x                    ), "& --
" 176 ( BC_2, BcAdd_H(14),           OUTPUT2,  x                    ), "& --
" 175 ( BC_2, BcAdd_H(15),           OUTPUT2,  x                    ), "& --
" 174 ( BC_2, BcAdd_H(16),           OUTPUT2,  x                    ), "& --
" 173 ( BC_2, BcAdd_H(17),           OUTPUT2,  x                    ), "& --
" 172 ( BC_2, BcAdd_H(18),           OUTPUT2,  x                    ), "& --
" 171 ( BC_2, BcAdd_H(19),           OUTPUT2,  x                    ), "& --
" 170 ( BC_2, BcAdd_H(20),           OUTPUT2,  x                    ), "& --
" 169 ( BC_2, BcAdd_H(21),           OUTPUT2,  x                    ), "& --

```

Boundary-Scan Register

```

" 168 ( BC_2, BcAdd_H(22),          OUTPUT2, x          ), "& --
" 167 ( BC_2, BcAdd_H(23),          OUTPUT2, x          ), "& --
" 166 ( BC_2, SysData_L(32),        BIDIR,   x, 150, 0,   WEAK1 ), "& --
" 165 ( BC_2, BcData_H(96),         BIDIR,   x, 153, 0,   Z      ), "& --
" 164 ( BC_2, BcData_H(32),         BIDIR,   x, 153, 0,   Z      ), "& --
" 163 ( BC_2, SysData_L(33),        BIDIR,   x, 150, 0,   WEAK1 ), "& --
" 162 ( BC_2, BcData_H(97),         BIDIR,   x, 153, 0,   Z      ), "& --
" 161 ( BC_2, BcData_H(33),         BIDIR,   x, 153, 0,   Z      ), "& --
" 160 ( BC_2, SysData_L(34),        BIDIR,   x, 150, 0,   WEAK1 ), "& --
" 159 ( BC_2, BcData_H(98),         BIDIR,   x, 153, 0,   Z      ), "& --
" 158 ( BC_2, BcData_H(34),         BIDIR,   x, 153, 0,   Z      ), "& --
" 157 ( BC_2, SysData_L(35),        BIDIR,   x, 150, 0,   WEAK1 ), "& --
" 156 ( BC_2, BcData_H(99),         BIDIR,   x, 153, 0,   Z      ), "& --
" 155 ( BC_2, BcData_H(35),         BIDIR,   x, 153, 0,   Z      ), "& --
" 154 ( BC_3, SysDataInClk_H(4),    INPUT,   x          ), "& --
" 153 ( BC_3, *,                    CONTROL, 0          ), "& -- sccell14
" 152 ( BC_2, SysDataOutClk_L(4),   OUTPUT2, x          ), "& --
" 151 ( BC_3, BcDataInClk_H(4),    INPUT,   x          ), "& --
" 150 ( BC_3, *,                    CONTROL, 0          ), "& -- bccell14
" 149 ( BC_2, SysData_L(36),        BIDIR,   x, 150, 0,   WEAK1 ), "& --
" 148 ( BC_2, BcData_H(100),        BIDIR,   x, 153, 0,   Z      ), "& --
" 147 ( BC_2, BcData_H(36),         BIDIR,   x, 153, 0,   Z      ), "& --
" 146 ( BC_2, SysData_L(37),        BIDIR,   x, 150, 0,   WEAK1 ), "& --
" 145 ( BC_2, BcData_H(101),        BIDIR,   x, 153, 0,   Z      ), "& --
" 144 ( BC_2, BcData_H(37),         BIDIR,   x, 153, 0,   Z      ), "& --
" 143 ( BC_2, SysData_L(38),        BIDIR,   x, 150, 0,   WEAK1 ), "& --
" 142 ( BC_2, BcData_H(102),        BIDIR,   x, 153, 0,   Z      ), "& --
" 141 ( BC_2, BcData_H(38),         BIDIR,   x, 153, 0,   Z      ), "& --
" 140 ( BC_2, SysData_L(39),        BIDIR,   x, 150, 0,   WEAK1 ), "& --
" 139 ( BC_2, BcData_H(103),        BIDIR,   x, 153, 0,   Z      ), "& --
" 138 ( BC_2, BcData_H(39),         BIDIR,   x, 153, 0,   Z      ), "& --
" 137 ( BC_2, SysCheck_L(4),        BIDIR,   x, 150, 0,   WEAK1 ), "& --
" 136 ( BC_2, BcCheck_H(12),        BIDIR,   x, 153, 0,   Z      ), "& --
" 135 ( BC_2, BcCheck_H(4),         BIDIR,   x, 153, 0,   Z      ), "& --
" 134 ( BC_2, BcDataOutClk_H(2),    OUTPUT2, x          ), "& --
" 133 ( BC_2, BcDataOutClk_L(2),    OUTPUT2, x          ), "& --
" 132 ( BC_2, SysData_L(40),        BIDIR,   x, 119, 0,   WEAK1 ), "& --
" 131 ( BC_2, BcData_H(104),        BIDIR,   x, 116, 0,   Z      ), "& --
" 130 ( BC_2, BcData_H(40),         BIDIR,   x, 116, 0,   Z      ), "& --
" 129 ( BC_2, SysData_L(41),        BIDIR,   x, 119, 0,   WEAK1 ), "& --
" 128 ( BC_2, BcData_H(105),        BIDIR,   x, 116, 0,   Z      ), "& --
" 127 ( BC_2, BcData_H(41),         BIDIR,   x, 116, 0,   Z      ), "& --
" 126 ( BC_2, SysData_L(42),        BIDIR,   x, 119, 0,   WEAK1 ), "& --
" 125 ( BC_2, BcData_H(106),        BIDIR,   x, 116, 0,   Z      ), "& --
" 124 ( BC_2, BcData_H(42),         BIDIR,   x, 116, 0,   Z      ), "& --
" 123 ( BC_2, SysData_L(43),        BIDIR,   x, 119, 0,   WEAK1 ), "& --
" 122 ( BC_2, BcData_H(107),        BIDIR,   x, 116, 0,   Z      ), "& --
" 121 ( BC_2, BcData_H(43),         BIDIR,   x, 116, 0,   Z      ), "& --
" 120 ( BC_3, SysDataInClk_H(5),    INPUT,   x          ), "& --
" 119 ( BC_3, *,                    CONTROL, 0          ), "& -- sccell15
" 118 ( BC_2, SysDataOutClk_L(5),   OUTPUT2, x          ), "& --
" 117 ( BC_3, BcDataInClk_H(5),    INPUT,   x          ), "& --
" 116 ( BC_3, *,                    CONTROL, 0          ), "& -- bccell15
" 115 ( BC_2, SysData_L(44),        BIDIR,   x, 119, 0,   WEAK1 ), "& --
" 114 ( BC_2, BcData_H(108),        BIDIR,   x, 116, 0,   Z      ), "& --
" 113 ( BC_2, BcData_H(44),         BIDIR,   x, 116, 0,   Z      ), "& --
" 112 ( BC_2, SysData_L(45),        BIDIR,   x, 119, 0,   WEAK1 ), "& --
" 111 ( BC_2, BcData_H(109),        BIDIR,   x, 116, 0,   Z      ), "& --
" 110 ( BC_2, BcData_H(45),         BIDIR,   x, 116, 0,   Z      ), "& --
" 109 ( BC_2, SysData_L(46),        BIDIR,   x, 119, 0,   WEAK1 ), "& --
" 108 ( BC_2, BcData_H(110),        BIDIR,   x, 116, 0,   Z      ), "& --
" 107 ( BC_2, BcData_H(46),         BIDIR,   x, 116, 0,   Z      ), "& --
" 106 ( BC_2, SysData_L(47),        BIDIR,   x, 119, 0,   WEAK1 ), "& --
" 105 ( BC_2, BcData_H(111),        BIDIR,   x, 116, 0,   Z      ), "& --
" 104 ( BC_2, BcData_H(47),         BIDIR,   x, 116, 0,   Z      ), "& --

```

Boundary-Scan Register

```

" 103 ( BC_2, SysCheck_L(5),          BIDIR,    x, 119, 0,    WEAK1 ), "& --
" 102 ( BC_2, BcCheck_H(13),         BIDIR,    x, 116, 0,    Z      ), "& --
" 101 ( BC_2, BcCheck_H(5),          BIDIR,    x, 116, 0,    Z      ), "& --
" 100 ( BC_2, SysData_L(48),         BIDIR,    x, 87, 0,    WEAK1 ), "& --
" 99  ( BC_2, BcData_H(112),         BIDIR,    x, 84, 0,    Z      ), "& --
" 98  ( BC_2, BcData_H(48),          BIDIR,    x, 84, 0,    Z      ), "& --
" 97  ( BC_2, SysData_L(49),         BIDIR,    x, 87, 0,    WEAK1 ), "& --
" 96  ( BC_2, BcData_H(113),         BIDIR,    x, 84, 0,    Z      ), "& --
" 95  ( BC_2, BcData_H(49),          BIDIR,    x, 84, 0,    Z      ), "& --
" 94  ( BC_2, SysData_L(50),         BIDIR,    x, 87, 0,    WEAK1 ), "& --
" 93  ( BC_2, BcData_H(114),         BIDIR,    x, 84, 0,    Z      ), "& --
" 92  ( BC_2, BcData_H(50),          BIDIR,    x, 84, 0,    Z      ), "& --
" 91  ( BC_2, SysData_L(51),         BIDIR,    x, 87, 0,    WEAK1 ), "& --
" 90  ( BC_2, BcData_H(115),         BIDIR,    x, 84, 0,    Z      ), "& --
" 89  ( BC_2, BcData_H(51),          BIDIR,    x, 84, 0,    Z      ), "& --
" 88  ( BC_3, SysDataInClk_H(6),     INPUT,    x                    ), "& --
" 87  ( BC_3, *,                     CONTROL,  0                    ), "& -- sccell16
" 86  ( BC_2, SysDataOutClk_L(6),     OUTPUT2,  x                    ), "& --
" 85  ( BC_3, BcDataInClk_H(6),      INPUT,    x                    ), "& --
" 84  ( BC_3, *,                     CONTROL,  0                    ), "& -- bccell16
" 83  ( BC_2, SysData_L(52),          BIDIR,    x, 87, 0,    WEAK1 ), "& --
" 82  ( BC_2, BcData_H(116),         BIDIR,    x, 84, 0,    Z      ), "& --
" 81  ( BC_2, BcData_H(52),          BIDIR,    x, 84, 0,    Z      ), "& --
" 80  ( BC_2, SysData_L(53),         BIDIR,    x, 87, 0,    WEAK1 ), "& --
" 79  ( BC_2, BcData_H(117),         BIDIR,    x, 84, 0,    Z      ), "& --
" 78  ( BC_2, BcData_H(53),          BIDIR,    x, 84, 0,    Z      ), "& --
" 77  ( BC_2, SysData_L(54),         BIDIR,    x, 87, 0,    WEAK1 ), "& --
" 76  ( BC_2, BcData_H(118),         BIDIR,    x, 84, 0,    Z      ), "& --
" 75  ( BC_2, BcData_H(54),          BIDIR,    x, 84, 0,    Z      ), "& --
" 74  ( BC_2, SysData_L(55),         BIDIR,    x, 87, 0,    WEAK1 ), "& --
" 73  ( BC_2, BcData_H(119),         BIDIR,    x, 84, 0,    Z      ), "& --
" 72  ( BC_2, BcData_H(55),          BIDIR,    x, 84, 0,    Z      ), "& --
" 71  ( BC_2, SysCheck_L(6),         BIDIR,    x, 87, 0,    WEAK1 ), "& --
" 70  ( BC_2, BcCheck_H(14),         BIDIR,    x, 84, 0,    Z      ), "& --
" 69  ( BC_2, BcCheck_H(6),          BIDIR,    x, 84, 0,    Z      ), "& --
" 68  ( BC_2, BcDataOutClk_H(3),     OUTPUT2,  x                    ), "& --
" 67  ( BC_2, BcDataOutClk_L(3),     OUTPUT2,  x                    ), "& --
" 66  ( BC_2, SysData_L(56),          BIDIR,    x, 53, 0,    WEAK1 ), "& --
" 65  ( BC_2, BcData_H(120),         BIDIR,    x, 50, 0,    Z      ), "& --
" 64  ( BC_2, BcData_H(56),          BIDIR,    x, 50, 0,    Z      ), "& --
" 63  ( BC_2, SysData_L(57),         BIDIR,    x, 53, 0,    WEAK1 ), "& --
" 62  ( BC_2, BcData_H(121),         BIDIR,    x, 50, 0,    Z      ), "& --
" 61  ( BC_2, BcData_H(57),          BIDIR,    x, 50, 0,    Z      ), "& --
" 60  ( BC_2, SysData_L(58),         BIDIR,    x, 53, 0,    WEAK1 ), "& --
" 59  ( BC_2, BcData_H(122),         BIDIR,    x, 50, 0,    Z      ), "& --
" 58  ( BC_2, BcData_H(58),          BIDIR,    x, 50, 0,    Z      ), "& --
" 57  ( BC_2, SysData_L(59),         BIDIR,    x, 53, 0,    WEAK1 ), "& --
" 56  ( BC_2, BcData_H(123),         BIDIR,    x, 50, 0,    Z      ), "& --
" 55  ( BC_2, BcData_H(59),          BIDIR,    x, 50, 0,    Z      ), "& --
" 54  ( BC_3, SysDataInClk_H(7),     INPUT,    x                    ), "& --
" 53  ( BC_3, *,                     CONTROL,  0                    ), "& -- sccell17
" 52  ( BC_2, SysDataOutClk_L(7),     OUTPUT2,  x                    ), "& --
" 51  ( BC_3, BcDataInClk_H(7),      INPUT,    x                    ), "& --
" 50  ( BC_3, *,                     CONTROL,  0                    ), "& -- bccell17
" 49  ( BC_2, SysData_L(60),          BIDIR,    x, 53, 0,    WEAK1 ), "& --
" 48  ( BC_2, BcData_H(124),         BIDIR,    x, 50, 0,    Z      ), "& --
" 47  ( BC_2, BcData_H(60),          BIDIR,    x, 50, 0,    Z      ), "& --
" 46  ( BC_2, SysData_L(61),         BIDIR,    x, 53, 0,    WEAK1 ), "& --
" 45  ( BC_2, BcData_H(125),         BIDIR,    x, 50, 0,    Z      ), "& --
" 44  ( BC_2, BcData_H(61),          BIDIR,    x, 50, 0,    Z      ), "& --
" 43  ( BC_2, SysData_L(62),         BIDIR,    x, 53, 0,    WEAK1 ), "& --
" 42  ( BC_2, BcData_H(126),         BIDIR,    x, 50, 0,    Z      ), "& --
" 41  ( BC_2, BcData_H(62),          BIDIR,    x, 50, 0,    Z      ), "& --
" 40  ( BC_2, SysData_L(63),         BIDIR,    x, 53, 0,    WEAK1 ), "& --
" 39  ( BC_2, BcData_H(127),         BIDIR,    x, 50, 0,    Z      ), "& --

```

Boundary-Scan Register

```
" 38 ( BC_2, BcData_H(63),          BIDIR,    x, 50, 0, Z    ), "& --
" 37 ( BC_2, SysCheck_L(7),         BIDIR,    x, 53, 0, WEAK1 ), "& --
" 36 ( BC_2, BcCheck_H(15),         BIDIR,    x, 50, 0, Z    ), "& --
" 35 ( BC_2, BcCheck_H(7),          BIDIR,    x, 50, 0, Z    ), "& --
" 34 ( BC_2, SysAddOut_L(0),         OUTPUT2,  x,          ), "& --
" 33 ( BC_2, SysAddOut_L(1),         OUTPUT2,  x,          ), "& --
" 32 ( BC_2, SysAddOut_L(2),         OUTPUT2,  x,          ), "& --
" 31 ( BC_2, SysAddOut_L(3),         OUTPUT2,  x,          ), "& --
" 30 ( BC_2, SysAddOut_L(4),         OUTPUT2,  x,          ), "& --
" 29 ( BC_2, SysAddOut_L(5),         OUTPUT2,  x,          ), "& --
" 28 ( BC_2, SysAddOut_L(6),         OUTPUT2,  x,          ), "& --
" 27 ( BC_2, SysAddOut_L(7),         OUTPUT2,  x,          ), "& --
" 26 ( BC_2, SysAddOutClk_L,         OUTPUT2,  x,          ), "& --
" 25 ( BC_2, SysAddOut_L(8),         OUTPUT2,  x,          ), "& --
" 24 ( BC_2, SysAddOut_L(9),         OUTPUT2,  x,          ), "& --
" 23 ( BC_2, SysAddOut_L(10),        OUTPUT2,  x,          ), "& --
" 22 ( BC_2, SysAddOut_L(11),        OUTPUT2,  x,          ), "& --
" 21 ( BC_2, SysAddOut_L(12),        OUTPUT2,  x,          ), "& --
" 20 ( BC_2, SysAddOut_L(13),        OUTPUT2,  x,          ), "& --
" 19 ( BC_2, SysAddOut_L(14),        OUTPUT2,  x,          ), "& --
" 18 ( BC_3, SysAddIn_L(0),          INPUT,    x,          ), "& --
" 17 ( BC_3, SysAddIn_L(1),          INPUT,    x,          ), "& --
" 16 ( BC_3, SysAddIn_L(2),          INPUT,    x,          ), "& --
" 15 ( BC_3, SysAddIn_L(3),          INPUT,    x,          ), "& --
" 14 ( BC_3, SysAddIn_L(4),          INPUT,    x,          ), "& --
" 13 ( BC_3, SysAddIn_L(5),          INPUT,    x,          ), "& --
" 12 ( BC_3, SysAddIn_L(6),          INPUT,    x,          ), "& --
" 11 ( BC_3, SysAddIn_L(7),          INPUT,    x,          ), "& --
" 10 ( BC_3, SysAddIn_L(8),          INPUT,    x,          ), "& --
" 9  ( BC_3, SysAddInClk_L,          INPUT,    x,          ), "& --
" 8  ( BC_3, SysAddIn_L(9),          INPUT,    x,          ), "& --
" 7  ( BC_3, SysAddIn_L(10),         INPUT,    x,          ), "& --
" 6  ( BC_3, SysAddIn_L(11),         INPUT,    x,          ), "& --
" 5  ( BC_3, SysAddIn_L(12),         INPUT,    x,          ), "& --
" 4  ( BC_3, SysAddIn_L(13),         INPUT,    x,          ), "& --
" 3  ( BC_3, SysAddIn_L(14),         INPUT,    x,          ), "& --
" 2  ( BC_3, SysFillValid_L,         INPUT,    x,          ), "& --
" 1  ( BC_3, SysDataInValid_L,       INPUT,    x,          ), "& --
" 0  ( BC_3, SysDataOutValid_L,      INPUT,    x,          );
```

attribute DESIGN_WARNING of Alpha_21264b: entity is

```
"1. IEEE 1149.1 circuits on Alpha 21264b are designed primarily to support "&
" testing in off-line module manufacturing environment. The SAMPLE/PRELOAD"&
" instruction support is designed primarily for supporting interconnection"&
" verification test and not for at-speed samples of pin data. "&
"2. TDO is Open-Drain signal. "&
"3. Add comment on port pin electrical characteristics: "&
"4. Comment out if compiler does not support this statement. "&
```

end Alpha_21264b;

Serial Icache Load Predecode Values

See the Alpha Motherboards Software Developer's Kit (SDK) for information.

PALcode Restrictions and Guidelines

D.1 Restriction 1 : Reset Sequence Required by Retire Logic and Mapper

For convenience of implementation, the Ibox retire logic done status bits are not initialized during reset. Instead, as shown in the example below, the first batch of valid instructions sweeps through inum-space and initializes these bits. The 80 status bits (one for each inflight instruction) must be marked not done by the first 80 instructions mapped after reset, and later marked done when those instructions are retired. Therefore, the first 20 fetch blocks must contain four valid instructions each, and must not contain any retire logic NOP instructions.

```

reset:
** (1) Initialize 80 retirator "done" status bits and
** the integer and floating mapper destinations.
** (2) Do A MTPR ITB_IA, which turns on the mapper source
** enables.
** (3) Create a map stall to complete the ITB_IA.
**
** State after execution of this code:
**   retirator initialized
**   destinations mapped
**   source mapping enabled
**   itb flushed
**
** The PALcode need not assume the following since the SROM is not
** required to do these:
**   dtb                flushed
**   dtb_asn0           0
**   dtb_asn1           0
**   dtb_alt_mode       0
**
*/

/*
** Initialize retirator and destination map, doing 80 retires.
*/
    addq   r31,r31,r0      /* initialize Int. Reg. 0*/
    addq   r31,r31,r1      /* initialize Int. Reg. 1*/
    addt   f31,f31,f0      /* initialize F.P. Reg. 0*/
    mult   f31,f31,f1      /* initialize F.P. Reg. 1*/

    addq   r31,r31,r2      /* initialize Int. Reg. 2*/
    addq   r31,r31,r3      /* initialize Int. Reg. 3*/

```

Restriction 1 : Reset Sequence Required by Retire Logic and Mapper

```
addt  f31,f31,f2      /* initialize F.P. Reg. 2*/
mult  f31,f31,f3      /* initialize F.P. Reg. 3*/

addq  r31,r31,r4      /* initialize Int. Reg. 4*/
addq  r31,r31,r5      /* initialize Int. Reg. 5*/
addt  f31,f31,f4      /* initialize F.P. Reg. 4*/
mult  f31,f31,f5      /* initialize F.P. Reg. 5*/

addq  r31,r31,r6      /* initialize Int. Reg. 6*/
addq  f31,r31,r7      /* initialize Int. Reg. 7*/
addt  f31,f31,f6      /* initialize F.P. Reg. 6*/
mult  f31,f31,f7      /* initialize F.P. Reg. 7*/

addq  r31,r31,r8      /* initialize Int. Reg. 8*/
addq  r31,r31,r9      /* initialize Int. Reg. 9*/
addt  f31,f31,f8      /* initialize F.P. Reg. 8*/
mult  f31,f31,f9      /* initialize F.P. Reg. 9*/

addq  r31,r31,r10     /* initialize Int. Reg. 10*/
addq  r31,r31,r11     /* initialize Int. Reg. 11*/
addt  f31,f31,f10     /* initialize F.P. Reg. 10*/
mult  f31,f31,f11     /* initialize F.P. Reg. 11*/

addq  r31,r31,r12     /* initialize Int. Reg. 12*/
addq  r31,r31,r13     /* initialize Int. Reg. 13*/
addt  f31,f31,f12     /* initialize F.P. Reg. 12*/
mult  f31,f31,f13     /* initialize F.P. Reg. 13*/

addq  r31,r31,r14     /* initialize Int. Reg. 14*/
addq  r31,r31,r15     /* initialize Int. Reg. 15*/
addt  f31,f31,f14     /* initialize F.P. Reg. 14*/
mult  f31,f31,f15     /* initialize F.P. Reg. 15*/

addq  r31,r31,r16     /* initialize Int. Reg. 16*/
addq  r31,r31,r17     /* initialize Int. Reg. 17*/
addt  f31,f31,f16     /* initialize F.P. Reg. 16*/
mult  f31,f31,f17     /* initialize F.P. Reg. 17*/

addq  r31,r31,r18     /* initialize Int. Reg. 18*/
addq  r31,r31,r19     /* initialize Int. Reg. 19*/
addt  f31,f31,f18     /* initialize F.P. Reg. 18*/
mult  f31,f31,f19     /* initialize F.P. Reg. 19*/

addq  r31,r31,r20     /* initialize Int. Reg. 20*/
addq  r31,r31,r21     /* initialize Int. Reg. 21*/
addt  f31,f31,f20     /* initialize F.P. Reg. 20*/
mult  f31,f31,f21     /* initialize F.P. Reg. 21*/

addq  r31,r31,r22     /* initialize Int. Reg. 22*/
addq  r31,r31,r23     /* initialize Int. Reg. 23*/
addt  f31,f31,f22     /* initialize F.P. Reg. 22*/
mult  f31,f31,f23     /* initialize F.P. Reg. 23*/

addq  r31,r31,r24     /* initialize Int. Reg. 24*/
addq  r31,r31,r25     /* initialize Int. Reg. 25*/
addt  f31,f31,f24     /* initialize F.P. Reg. 24*/
mult  f31,f31,f25     /* initialize F.P. Reg. 25*/

addq  r31,r31,r26     /* initialize Int. Reg. 26*/
```

Restriction 1 : Reset Sequence Required by Retire Logic and Mapper

```
addq r31,r31,r27 /* initialize Int. Reg. 27*/
addt f31,f31,f26 /* initialize F.P. Reg. 26*/
mult f31,f31,f27 /* initialize F.P. Reg. 27*/

addq r31,r31,r28 /* initialize Int. Reg. 28*/
addq r31,r31,r29 /* initialize Int. Reg. 29*/
addt f31,f31,f28 /* initialize F.P. Reg. 28*/
mult f31,f31,f29 /* initialize F.P. Reg. 29*/

addq r31,r31,r30 /* initialize Int. Reg. 30*/
addt f31,f31,f30 /* initialize F.P. Reg. 30*/
addq r31,r31,r0 /* initialize retirator 63*/
addq r31,r31,r0 /* initialize retirator 64*/

addq r31,r31,r0 /* initialize retirator 65*/
addq r31,r31,r0 /* initialize retirator 66*/
addq r31,r31,r0 /* initialize retirator 67*/
addq r31,r31,r0 /* initialize retirator 68*/

addq r31,r31,r0 /* initialize retirator 69*/
addq r31,r31,r0 /* initialize retirator 70*/
addq r31,r31,r0 /* initialize retirator 71*/
addq r31,r31,r0 /* initialize retirator 72*/

addq r31,r31,r0 /* initialize retirator 73*/
addq r31,r31,r0 /* initialize retirator 74*/
addq r31,r31,r0 /* initialize retirator 75*/
addq r31,r31,r0 /* initialize retirator 76*/

addq r31,r31,r0 /* initialize retirator 77*/
addq r31,r31,r0 /* initialize retirator 78*/
addq r31,r31,r0 /* initialize retirator 79*/
addq r31,r31,r0 /* initialize retirator 80*/

/* stop deleting*/

mtptr r31,EV6__ITB_IA /* flush the ITB (SCRBRD=4) *** this also
                       turns on mapper source enables *****/
mtptr r31,EV6__DTB_IA /* flush the DTB (SCRBRD=7)*/
mtptr r31,EV6__VA_CTL /* clear VA_CTL (SCRBRD=5)*/
mtptr r31,EV6__M_CTL /* clear M_CTL (SCRBRD=6)*/

/*
** Create a stall outside the IQ until the mtptr EV6__ITB_IA retires.
** We can use DTB_ASNx even though we don't seem to follow the restriction on
** scoreboard bits (4-7).It's okay because there are no real dstream
** operations happening.
*/
mtptr r31,EV6__DTB_ASN0 /* clear DTB_ASN0 (SCRBRD=4) creates a map-
                        stall under the above mtptr to SCRBRD=4*/
mtptr r31,EV6__DTB_ASN1 /* clear DTB_ASN1 (SCRBRD=7)*/
mtptr r31,EV6__CC_CTL /* clear CC_CTL (SCRBRD=5)*/
mtptr r31,EV6__DTB_ALT_MODE/* clear DTB_ALT_MODE (SCRBRD=6)*/

/*
** MAP_SHADOW_REGISTERS
**
** The shadow registers are mapped. This code may be done by the SROM
```

Restriction 1 : Reset Sequence Required by Retire Logic and Mapper

```
** or the PALcode, but it must be done in the manner and order below.
**
** It assumes that the retirator has been initialized, that the
** non-shadow registers are mapped, and that mapper source enables are on.
**
** Source enables are on. For fault-reset and wake from sleep, we need to
** ensure we are in the icache so we don't fetch junk that touches the
** shadow sources before we write the destinations. For normal reset,
** we are already in the icache. However, so this macro is useful for
** all cases, force the code into the icache before doing the mapping.
**
** Assume for fault-reset, and wake from sleep case, the exc_addr is
** stored in r1.
*/
    addq   r31,r31,r0      /* nop*/
    addq   r31,r31,r0      /* nop*/
    addq   r31,r31,r0      /* nop*/
    br     r31, tch0       /* fetch in next block*/

    .align 3
nxt0: lda   r0,0x0086(r31) /* load I_CTL....*/
    mtptr  r0,EV6__I_CTL  /* .....SDE=2, IC_EN=3 (SCRBRD=4)*/
    br     r31, nxt1      /* continue executing in next block*/
tch0: br    r31, tch1     /* fetch in next block*/

nxt1: mtptr r31,EV6__IER_CM /* clear IER_CM (SCRBRD=4) creates a map-stall
                        under the above mtptr to SCRBRD=4*/
    addq   r31,r31,r0      /* nop*/
    br     r31, nxt2      /* continue executing in next block*/
tch1: br    r31, tch2     /* fetch in next block*/

nxt2: addq   r31,r31,r0      /* 1st buffer fetch block for above map-
                        stall*/
    addq   r31,r31,r0      /* nop*/
    br     r31, nxt3      /* continue executing in next block*/
tch2: br    r31, tch3     /* fetch in next block*/

nxt3: addq   r31,r31,r0      /* 2nd buffer fetch block for above map-stall*/
    addq   r31,r31,r0      /* nop*/
    br     r31, nxt4      /* continue executing in next block*/
tch3: br    r31, tch4     /* fetch in next block*/

nxt4: addq   r31,r31,r0      /* need 3rd buffer fetch block to get correct
                        SDE bit for next fetch block*/
    addq   r31,r31,r0      /* nop*/
    br     r31, nxt5      /* continue executing in next block*/
tch4: br    r31, tch5     /* fetch in next block*/

nxt5: addq   r31,r31,r4      /* initialize Shadow Reg. 0*/
    addq   r31,r31,r5      /* initialize Shadow Reg. 1*/
    br     r31, nxt6      /* continue executing in next block*/
tch5: br    r31, tch6     /* fetch in next block*/

nxt6: addq   r31,r31,r6      /* initialize Shadow Reg. 2*/
    addq   r31,r31,r7      /* initialize Shadow Reg. 3*/
    br     r31, nxt7      /* continue executing in next block*/
tch6: br    r31, tch7     /* fetch in next block*/

nxt7: addq   r31,r31,r20     /* initialize Shadow Reg. 4*/
```

Restriction 1 : Reset Sequence Required by Retire Logic and Mapper

```
        addq   r31,r31,r21      /* initialize Shadow Reg. 5*/
        br     r31, nxt8       /* continue executing in next block*/
tch7:   br     r31, tch8       /* fetch in next block*/

nxt8:   addq   r31,r31,r22      /* initialize Shadow Reg. 6*/
        addq   r31,r31,r23      /* initialize Shadow Reg. 7*/
        br     r31, nxt9       /* continue executing in next block*/
tch8:   br     r31, nxt0       /* go back to 1st block and start executing*/
nxt9:

/*
** INIT_WRITE_MANY
**
** Write the cbox write many chain, initializing the bcache configuration.
**
** This code is on a cache block boundary,
**
** *** the bcache is initialized OFF for the burnin test ***
*/

/*
** Because we aligned on and fit into a icache block, and because sbe=0,
** and because we do an mb at the beginning (which blocks further progress
** until the entire block has been fetched in), we don't have to
** fool with pulling this code in before executing it.
*/

#undef bc_enable_a
#undef init_mode_a
#undef bc_size_a
#undef zeroblk_enable_a
#undef enable_evict_a
#undef set_dirty_enable_a
#undef bc_bank_enable_a
#undef bc_wrt_sts_a

#define bc_enable_a          0
#define init_mode_a         0
#define bc_size_a           0
#define zeroblk_enable_a    1
#define enable_evict_a      0
#define set_dirty_enable_a  0
#define bc_bank_enable_a    0
#define bc_wrt_sts_a        0

loadwm:
        lda    r1, WRITE_MANY_CHAIN_H(r31)
        sll    r1, 32, r1      /* data<35:32> */
        LDLI(r1, WRITE_MANY_CHAIN_L, r1)      /* data<31:00> */
        addq   r31,6,r0       /* shift in 6x 6-bits*/
        mb     /* wait for all istream/dstream to complete*/

        br     r31, bccshf
        .align 6
bccshf:mtpr r1,EV6__DATA      /* shift in 6 bits*/
        subq   r0,1,r0        /* decrement R0*/
        beq    r0,bccend      /* done if R0 is zero*/
        srl    r1,6,r1        /* align next 6 bits*/
```

Restriction 1 : Reset Sequence Required by Retire Logic and Mapper

```
br      r31,bccshf          /* continue shifting*/
bccend:mtpr r31,EV6__EXC_ADDR + 16/* dummy IPR write - sets SCBD bit 4 */
addq   r31,r31,r0          /* nop*/
addq   r31,r31,r1          /* nop*/

mtpr   r31,EV6__EXC_ADDR + 16 /* also a dummy IPR write -
                               /* stalls until above write
                               /* retires*/

beq    r31, bccnxt         /* predicts fall through in PALmode*/
br     r31, .-4            /* fools ibox predictor into infinite loop*/
addq   r31,r31,r1          /* nop*/

bccnxt:addq r31,4,r0        /* load PCTX....*/
mtpr   r0,EV6__PROCESS_CONTEXT /* ..... FPE=1 (SCRBRD=4)*/
lda    r0,DC_CTL_INIT_K(r31) /* load DC_CTL....*/
mtpr   r0,EV6__DC_CTL      /* .....ECC_EN=0, FHIT=0, SET_EN=3
                               /* (SCRBRD=6)*/

addq   r31,r31,r0          /* nop*/
addq   r31,r31,r1          /* nop*/
lda    r0,0xff61(r31)     /* R0 = ^xff61 (superpage) */
zap    r0,0xfc,r0         /* PTE protection for DTB write in next
                               block*/

mtpr   r31,EV6__DTB_TAG0 /* write DTB_TAG0 (SCRBRD=2,6)*/
mtpr   r31,EV6__DTB_TAG1 /* write DTB_TAG1 (SCRBRD=1,5)*/
mtpr   r0,EV6__DTB_PTE0 /* write DTB_PTE0 (SCRBRD=0,4)*/
mtpr   r0,EV6__DTB_PTE1 /* write DTB_PTE1 (SCRBRD=3,7)*/

mtpr   r31,EV6__SIRR      /* clear SIRR (SCRBRD=4)*/
lda    r0,0x08FF(r31)     /* load FPCR....*/
sll    r0,52,r0           /* .....initial FPCR value*/
itofst r0, f0             /* nop          itoftr0,f0; value = 0x8FF0000000000000*/

mt_fpcr f0                /* nop          mt_fpcrf0,f0,f0; do the load*/
lda    r0,0x2086(r31)     /* load I_CTL....*/
ldah   r0,0x0050(r0)      /* .....TB_MB_EN=1, CALL_PAL_R23=1, SL_XMIT=1,
                               /* SBE=0, SDE=2, IC_EN=3*/
mtpr   r0,EV6__I_CTL     /* value = 0x0000000000502086 (SCRBRD=4)*/

mtpr   r31,EV6__CC        /* clear CC (SCRBRD=5)*/
lda    r0,0x001F(r31)     /* write-one-to-clear bits in HW_INT_CLR,
                               /* I_STAT and DC_STAT*/
sll    r0,28,r0           /* value = 0x00000001F0000000*/
mtpr   r0,EV6__HW_INT_CLR/* clear bits in HW_INT_CLR (SCRBRD=4)*/

mtpr   r0,EV6__I_STAT     /* clear bits in I_STAT
                               /*(SCRBRD=4) creates a map-stall
                               /* under the above mtptr to SCRBRD=4*/
lda    r0,0x001F(r31)     /* value = 0x000000000000001F*/
mtpr   r0,EV6__DC_STAT   /* clear bits in DC_STAT (SCRBRD=6)*/
addq   r31,r31,r0          /* nop*/

mtpr   r31,EV6__PCTR_CTL /* 1st buffer fetch block for above map-stall
                               /* and 1st clear PCTR_CTL (SCRBRD=4)*/
bis    r31,1,r0           /* set up value for demon write*/
bis    r31,1,r0           /* set up value for demon write*/
mulq/v r31,r31,r0         /* nop*/
```

Restriction 1 : Reset Sequence Required by Retire Logic and Mapper

```
mtpr    r31,EV6_PCTR_CTL /* 2nd buffer fetch block for above map-stall
                                     /* and 2nd clear PCTR_CTL (SCRBRD=4)*/
bis     r31,1,r0          /* set up value for demon write*/
bis     r31,1,r0          /* set up value for demon write*/
mulq    r31,r31,r0        /* nop*/

lda     r0,0x780(r31)     /* this is new initialization stuff to
                                     prevent*/
mb
whint   r0                /* ld/st below from going off-chip */
mb
bis     r31,1,r0          /* set up value for demon write*/

ldq_p   r1,0x780(r31)     /* flush Pipe 0 LD logic*/
ldq_p   r0,0x788(r31)     /* flush Pipe 1 LD logic*/
mb
mb
                                     /* wait for LD's to complete*/
                                     /* wait for LD's to complete*/

stq_p   r1,0x780(r31)     /* flush Pipe 0 ST logic*/
stq_p   r0,0x788(r31)     /* flush Pipe 1 ST logic*/
bis     r31, 32, r0       /* load loop count of 32*/
jsr_init_loop:
bsr     r31,jsr_init_loop_nxt      /* JSR to PC+4*/
jsr_init_loop_nxt:
stq_p   r1,0x780(r31)     /* flush Pipe 0 ST logic*/
subq    r0,1,r0           /* decrement loop count*/
beq     r0,jsr_init_done  /* done?*/
br      r31,jsr_init_loop /* continue loop*/

jsr_init_done:
lda     r0,0x03FF(r31)    /* create FP one.... */
sll     r0,52,r0          /* .....value = 0x3FF0000000000000 */
itoft   r0,f0             /* put it into F0 reg */
addq    r31,r31,r1        /* nop (also clears R1) */

mult    f0,f0,f0          /* flush mul-pipe */
addt    f0,f0,f0          /* flush add-pipe */
divt    f0,f0,f0          /* flush div-pipe */
sqrtd   f0,f0             /* flush div-pipe */

cvtqt   f0,f0             /* flush add-pipe (integer logic) */
perr    r31,r31,r0        /* flush MVI logic */
maxuw4   r31,r31,r0       /* flush MVI logic */
pkwb    r31,r0            /* flush MVI logic */

rc      r0                /* clear interrupt flag*/
addq    r31,r31,r1        /* nop (also clears R1)*/
addq    r31,r31,r1        /* nop (also clears R1)*/
addq    r31,r31,r1        /* nop (also clears R1)*/
/*
* This palbase init exists for the rare cases
* when this code is loaded into upper memory.
* That is the case when this code is loaded
* and executed in memory on a system that has
* already been initialized. This technique
* can sometimes be used to debug snippets of
* this code.
*/
```

Restriction 2 : No Multiple Writers to IPRs in Same Scoreboard Group

```
        br      r31,palbase_init
palbase_init:
        br      r0, br60          /* r0 <- current location */
br60:   lda     r1, (EntryPoint-br60)(r0) /* r1 <- location of codebase */
        mtpr   r1, EV6__PAL_BASE /* set up pal_base register */

        bis    r31, 2, r0
        mtpr   r0, EV6__VA_CTL

        bis    r31, 8, r0
        mtpr   r0, EV6__M_CTL

        br     r0, jmp0
jmp0:   addq   r0, (jmp1-jmp0+1), r0
        hw_rets/jmp(r0)
jmp1:

        lda    r1, 1(r31)        /* r1 <- cc_ctl enable bit */
        sll   r1, 32, r1
        mtpr   r1, EV6__CC_CTL  /* Enable/clear the cycle counter. */

/*
** Now initialize the dcache to allow the
** minidebugger so save gpr's
*/
```

D.2 Restriction 2 : No Multiple Writers to IPRs in Same Scoreboard Group

For convenience of implementation, only one explicit writer (HW_MTPR) to IPRs that are in the same group can appear in the same fetch block (octaword-aligned octaword). Multiple explicit writers to IPRs that are not in the same scoreboard group can appear. If this restriction is violated, the IPR readers might not see the in-order state. Also, the IPR might ultimately end up with a bad value.

D.3 Restriction 4 : No Writers and Readers to IPRs in Same Scoreboard Group

This restriction is made for the convenience of microprocessor implementation. An explicit reader of an IPR in a particular scoreboard group cannot follow an explicit writer (HW_MTPR) to an IPR in that same scoreboard group within one fetch block (octaword-aligned octaword). Also within one fetch block, an implicit reader of an IPR in a particular scoreboard group cannot follow an explicit writer (HW_MTPR) to an IPR in that scoreboard group. This restriction covers writes to DTB_PTE or DTB_TAG followed by LD, ST, or any memory operation, including all types of JMP instructions and HW_RET instructions that do not have the STALL bit set.

D.4 Guideline 6 : Avoid Consecutive Read-Modify-Write-Read-Modify-Write

Avoid consecutive read-modify-write-read-modify-write sequences to IPRs in the same scoreboard group.

The latency between the first write and the second read is determined by the retire latency of the IPR. For convenience of implementation, the latency between the time when the read is issued and when the final write is issued depends on the run-time contents of the issue queue. It is somewhere between four and nine cycles, even if there is no data dependency between the read and write.

D.5 Restriction 7 : Replay Trap, Interrupt Code Sequence, and STF/ITOF

On an Mbox replay trap, the 21264/EV68A Ibox guarantees that the refetched load or store instruction that caused the trap is issued before any newer load or store instructions. For load and integer store instructions, this is a consequence of the natural operation of the issue queue. The refetched instruction enters the age-prioritized queue ahead of newer load and store instructions and does not have any dependencies on dirty registers.

Because there is no overhead time for checking these register dependencies (that is, it is known upon enqueueing that there are no dirty registers), the queue will issue the refetched instruction in priority order. For floating-point store instructions, there is normally some overhead associated with checking the floating-point source register dirty status, so the store instruction would normally wait before being issued. This would have the undesired consequence of allowing newer load and store instructions to be issued out of order. A deadlock can occur if issuing the instructions out-of-order causes the floating-point store instruction to continually replay the trap. To avoid the deadlock on a floating-point store instruction replay trap, the source register dirty status is not checked (the source register is assumed to be clean because the store instruction was issued previously).

The hardware mechanism that keeps track of replayed floating-point store instructions, and cancels the dirty register check, requires some software restrictions to guarantee that it is applied appropriately to the replayed instruction and not to other floating-point store instructions. The hardware mechanism marks the position in the fetch block (low two bits of the PC) where the replay trap occurred. This action cancels the dirty floating-point source register check of the next valid instruction enqueued to the integer queue (integer, all load and store, and ITOF instructions) that has the same position in the fetch block (normally the replayed STF). If the PC is somehow diverted to a PALcode flow, this hardware might inadvertently cancel the register check of some other STF (or ITOF) instruction. Fortunately, there are a minimal number of reasons why the PC might be diverted during a replay trap. They are interrupts and ITB fills.

The following PALcode example shows that an STF or ITOF instruction, in a given position in a fetch block, must be preceded by a valid instruction that is issued out of the integer queue in the same position in an earlier fetch block. Acceptable instruction classes include load, integer store, and integer operate instructions that do not have R31 as a destination or branch.

Restriction 9 : PALmode Istream Address Ranges

```
Bad_interrupt_flow_entry:

ADDQ R31,R31,R0
STF Fa,(Rb) ; This STF might not undergo a dirty source register
; check and might give wrong results
ADDQ R31,R31,R0
ADDQ R31,R31,R0
.....
Good_interrupt_flow_entry:
ADDQ R31,R31,R0; Enables FP dirty source register
; check for (PC[1:0] == 00)
ADDQ R31,R31,R0; Enables FP dirty source register
; check for (PC[1:0] == 01)
ADDQ R31,R31,R0; Enables FP dirty source register
; check for (PC[1:0] == 10)
ADDQ R31,R31,R0; Enables FP dirty source register
; check for (PC[1:0] == 11)
ADDQ R31,R31,R0
STF Fa,(Rb); This STF will successfully undergo
; a dirty source register check
ADDQ R31,R31,R0
ADDQ R31,R31,R0
```

D.6 Restriction 9 : PALmode Istream Address Ranges

PALmode[physical] Istream addresses must ensure proper sign extension for the selected value of I_CTL[VA_48]. When I_CTL[VA_48] is clear, indicating 43-bit virtual address format, PALmode[physical] Istream addresses must sign-extend address bits above bit 42 although the physical address range is 44 bits. An illegal address can only be generated by a PALmode JSR-type instruction or a HW_RET instruction returning to a PALmode address.

D.7 Restriction 10: Duplicate IPR Mode Bits

The virtual address size is selectable by programming IPR bits I_CTL[VA_48] and VA_CTL[VA_48]. These bit values should usually be equal when operating in native (virtual) mode. The I_CTL[VA_48] bit determines the DTB double3/double4 PALcode entry, the JSR mispredict comparison width, the VPC address generation width, the Istream ACV limits, and the IVA_FORM format selection. The VA_CTL[VA_48] bit determines the VA_FORM format selection and the Dstream ACV limits. IPR mode bits I_CTL[VA_FORM_32] and VA_CTL[VA_FORM_32] should be consistent when executing in native mode.

D.8 Restriction 11: Ibox IPR Update Synchronization

When updating any Ibox IPR, a return to native (virtual) mode should use the HW_RET instruction with the associated STALL bit set to ensure that the updated IPR value affects all instructions following the return path. The new IPR value takes effect only after the associated HW_MTPR instruction is retired.

For update to some IPR fields with propagation delay, such as I_CTL[SDE] and PCTX[FPE], synchronization as described in Section D.32 is the preferred method of synchronization.

D.9 Restriction 12: MFPR of Implicitly-Written IPRs EXC_ADDR, IVA_FORM, and EXC_SUM

Implicitly written IPRs are non-renamed hardware registers that must be available for subsequent traps. After any trap to PALcode, hardware protects the values from a second implicit write by locking these registers and delaying subsequent traps for a *safe* (limited time). Their values can be read reliably by a HW_MFPR within the first four instructions of a PALcode flow and prior to any taken branch in that PALcode flow, whichever is earlier. These instructions should not include PALmode trapping instructions. After the delimiting instruction defined above retires, these registers are unlocked and may change due to new exception conditions.

If a second exception occurs before the registers are unlocked, it will be either delayed or forced to replay trap (a non-PALmode trap) until the register has been unlocked. After being unlocked, a subsequent new path exception condition will be allowed to reload the register and trap to PALcode. The 21264/EV68A may complete execution of the first PALcode flow, encountering the second exception condition before the delimiting instruction is retired, hence the need for the locking mechanism to ensure visibility of the initial register value.

The VA_FORM, VA, and MM_STAT registers are not included in this list of protected IPRs. See Section D.24 for a description of how to protect these IPRs from subsequent implicit writers.

D.10 Restriction 13 : DTB Fill Flow Collision

Two DTB fill flows might collide such that the HW_MTPR's in the second fill could be issued before all of the HW_MTPR's in the first PALcode flow are retired. This can be prevented by putting appropriate software scoreboard barriers in the PALcode flow.

D.11 Restriction 14 : HW_RET

There can be no HW_RET in the first fetch block of a PALcode routine, other than CALL_PAL routines. With a HW_RET in the first fetch block of a PALcode routine, the HW_RET will be mispredicted and the JSR/RETURN stack could lose its synchronization.

D.12 Guideline 16 : JSR-BAD VA

A JSR memory format instruction that generates a bad VA (IACV) trap requires PALcode assistance to determine the correct exception address. If the EXC_SUM[BAD_IVA] is set, bits [63,1] of the exception address are valid in the VA IPR and not the EXC_ADDR as usual. The PALmode bit, however, is always located in EXC_ADDR[0] and must be combined, if necessary, by PALcode to determine the full exception address.

D.13 Restriction 17: MTPR to DTB_TAG0/DTB_PTE0/DTB_TAG1/DTB_PTE1

These four write operations must be executed atomically, that is, either all four must be retired or none of them may be retired.

D.14 Restriction 18: No FP Operates, FP Conditional Branches, FTOI, or STF in Same Fetch Block as HW_MTPR

No FP operate instructions (including Mx_FPCR), FP conditional branches, FTOI register move instructions, or FP store instructions are allowed in the same fetch block as any HW_MTPR instructions. This includes ADDx/MULx/DIVx/SQRTx/FPConditionalBranch/STx/FTOIx, where *x* is any applicable FP data type, but does not include LDx/ITOFx.

D.15 Restriction 19: HW_RET/STALL After Updating the FPCR by way of MT_FPCR in PALmode

FPCR updating occurs in hardware based on the retirement of a nontrapping version of MT_FPCR (in PALcode). Use a HW_RET/STALL after the nontrapping MT_FPCR to achieve minimum latency (four cycles) between the retiring of the MT_FPCR and the first FLOP that uses the updated FPCR.

D.16 Guideline 20 : I_CTL[SBE] Stream Buffer Enable

The I_CTL[SBE] bits should not be enabled when running with the Icache disabled to avoid potentially long fill delays. When the Icache is disabled, the only method of supplying instructions is by way of a stream hit. If the fill is returned in non-sequential wrap order, the stream will continue fetching through the entire page while waiting for a hit. Normally the data will be found in the cache.

D.17 Restriction 21: HW_RET/STALL After HW_MTPR ASN0/ASN1

There must be a scoreboard bit-to-register dependency chain to prevent HW_MTPR ASN0 or HW_MTPR ASN1 from being issued while any of scoreboard bits [7:4] are set. The following example contains a code sequence that creates the dependency chain.

```
:Assume Ra holds value to write to ASN0/ASN1
HW_MFPR R0, VA, SCBD<7,6,5,4>
XOR R0, R0, R0
BIS R0, R9, R9
```

Restriction 22: HW_RET/STALL After HW_MTPR IS0/IS1

```
BIS R31, R31, R31
HW_MTPR R9, ASN0, SCBD<4>
HW_MTPR R9, ASN1, SCBD<7>
```

This sequence guarantees, through the register dependency on R0, that neither HW_MTPR are issued before scoreboard bits [7:4] are cleared. In addition, there must be a HW_RET/STALL after a HW_MTPR ASN0/HW_MTPR ASN1 pair. Finally, these two writes must be executed atomically, that is, either both must be retired or neither may be retired.

D.18 Restriction 22: HW_RET/STALL After HW_MTPR IS0/IS1

There must be a scoreboard bit-to-register dependency chain to prevent either HW_MTPR IS0 or HW_MTPR IS1 from issuing instructions while *any* of scoreboard bits [7:4] are set. The following example contains a code sequence that creates the dependency chain.

```
HW_MFPR R0, VA, SCBD<7,6,5,4>,R0
XOR R0, R0, R0
BIS R0, R9, R9
BIS R31 ,R31, R31
HW_MTPR R9, IS0, SCBD<6>
HW_MTPR R9, IS1, SCBD<7>
```

This sequence guarantees, through the register dependency on R0, that neither HW_MTPR are issued before scoreboard bits [7:4] are cleared. There must be a HW_RET/STALL after an HW_MTPR IS0/HW_MTPR IS1 pair. Also, these two writes must be executed atomically, that is, either both must be retired or neither may be retired.

D.19 Restriction 23: HW_ST/P/CONDITIONAL Does Not Clear the Lock Flag

A HW_ST/P/CONDITIONAL will not *clear* the lock flag such that a successive store-conditional (either STx_C or HW_ST/C) might succeed even in the absence of a load-locked instruction. In the 21264/EV68A, a store-conditional is forced to fail if there is an intervening memory operation between the store-conditional and its address-matching LDxL. The following example shows the memory operations.

```
LDL/Q/F/G/S/T
STL/Q/F/G/S/T
LDQ_U (not to R31)
STQ_U
```

Absent from this list are HW_LD (any type), HW_ST (any type), ECB, and WH64. Their absence implies that they will *not* force a subsequent store-conditional instruction to fail. PALcode *must* insert a memory operation from the above list after a HW_ST/CONDITIONAL in order to force a future store-conditional to fail if it was not preceded by a load-locked operation:

```
HW_LDxL
```

Restriction 24: HW_RET/STALL After HW_MTPR IC_FLUSH, IC_FLUSH_ASM,

```
xxx
HW_ST/C -> R0
Bxx R0, try_again
STQ ; Force next ST/C to fail if no preceding LDxL
HW_RET
```

D.20 Restriction 24: HW_RET/STALL After HW_MTPR IC_FLUSH, IC_FLUSH_ASM, CLEAR_MAP

There must be a HW_RET/STALL after a HW_MTPR IC_FLUSH, IC_FLUSH_ASM, or CLEAR_MAP. The Icache flush associated with these instructions will not occur until the HW_RET/STALL occurs and all outstanding Istream fetches have been completed.

Also, there must be a guarantee that the HW_MTPR IC_FLUSH or HW_MTPR IC_FLUSH_ASM will not be retired simultaneously with the HW_RET/STALL. This can be ensured by inserting a conditional branch between the two (BNE R31, 0 cannot be mispredicted in PALmode), or by ensuring at least 10 instructions between the MTPR instruction and the HW_RET/STALL containing at least one instruction in each quad aligned group with a valid destination. Finally, the HW_RET/STALL that is used for CLEAR_MAP cannot trigger a cache flush. That is, if both a CLEAR_MAP and IC_FLUSH are desired, there must be two HW_RET/STALLs, one following each HW_MTPR.

D.21 Restriction 25: HW_MTPR ITB_IA After Reset

An HW_MTPR ITB_IA is required in the reset PALcode to initialize the ITB. It is also required that PALcode not be exited, even via a mispredicted path until this HW_MTPR ITB_IA has been retired. PALmode can change temporarily after fetching a HW_RET, regardless of the STALL qualifier, down a mispredicted path leading to use of the ITB before it is actually initialized.

Unexpected instruction fetch and execution can occur following misprediction of any memory format control instruction (JMP, JSR, RET, JSR_CO, or HW_JMP, HW_JSR, HW_RET, HW_JSR_CO regardless of the STALL qualifier), or after any mispredicted conditional branch instruction. If the unexpected instruction flow contains a HW_RET instruction, PALmode may be exited prematurely.

One way to ensure that PALmode is not exited is to place the HW_MTPR ITB_IA at least 80 instructions before any possible HW_RET instruction can be encountered via any fetch path. Since memory format control instructions can mispredict to any cache location, they should also be avoided within these 80 instructions.

D.22 Guideline 26: Conditional Branches in PALcode

To avoid pollution of the branch predictors and improve overall branch prediction accuracy, conditional branch instructions in PALcode will be predicted to not be taken. The only exception to this rule are conditional branches within the first cache fetch (up to four instructions) of all PALcode flows except CALL_PAL flows. Conditional branches should be avoided in this window.

D.23 Restriction 27: Reset of 'Force-Fail Lock Flag' State in PALcode

A virtual mode load or store is required in PALcode before the execution of any load-locked or store-conditional instructions. The virtual-mode load or store may not be a HW_LD, HW_ST, LDx_L, ECB, or WH64.

D.24 Restriction 28: Enforce Ordering Between IPRs Implicitly Written by Loads and Subsequent Loads

Certain IPRs, which are updated as a result of faulting memory operations, require software assistance to maintain ordering against newer instructions. Consider the following code sequence:

```
HW_MFPR IPR_MM_STAT
LDQ rx, (ry)
```

These instructions would typically be issued in-order. The HW_MFPR is data-ready and both instructions use a lower subcluster. However, the HW_MFPRs (and HW_MTPRs) respond to certain resource-busy indications and are not issued when the Mbox informs the Ibox that a certain set of resources (store-bubbles) are busy. The LDs respond to a different set of resource-busy indications (load-bubbles) and could be issued around the HW_MFPR in the presence of the former. Software assistance is required to enforce the issue order. One sure way to enforce the issue order is to insert an MB instruction before the first load that occurs after the HW_MFPR MM_STAT. The VA, VA_FORM, and DC_CTL registers require a similar constraint. All LOAD instructions except HW_LD might modify any or all of these registers. HW_LD does not modify MM_STAT.

D.25 Guideline 29 : JSR, JMP, RET, and JSR_COR in PALcode

Unprivileged JSR, JMP, RET, and JSR_COR instructions will always mispredict when used in PALcode. In addition, HW_RET to a PALmode target will always mispredict since the JSR stack only predicts native-mode return addresses. HW_RET to a native-mode target uses the JSR stack for prediction and should usually be used when exiting PALmode in order to maintain JSR stack alignment since all PALmode traps also push the value of the EXC_ADDR on the JSR stack.

Privileged versions of the JSR type instructions (HW_JSR, HW_JMP, HW_JSR_COR) can be used both within PALmode or to exit PALmode and generate a predicted target based on their hint bits and the current processor PALmode state.

D.26 Restriction 30 : HW_MTPR and HW_MFPR to the Cbox CSR

External bus activity must be isolated from writes and reads to the Cbox CSR. This requires that all Dstream and Istream fills must be avoided until after the HW_MTPR/ HW_MFPR updates are completed. An MB instruction can block Dstream activity, but blocking all Istream fills, including prefetches, requires more extensive code. The following code example blocks all Istream fill requests and stalls instruction fetch until after the desired MTPR/MFPR action is completed. This code disables Istream prefetching by way of a HW_MTPR to I_CTL[SBE], IC_FLUSH, and HW_RET_STALL sequence.

Restriction 30 : HW_MTPR and HW_MFPR to the Cbox CSR

```
ALIGN_FETCH_BLOCK
sys__cbox:
    mb                                ; quiet the dstream
    hw_mfpr p6, EV6__I_CTL            ; (4,0L) get i_ctl
    lda    p4, ^xF0FF(r31)           ; mask for clearing SBE bits
    and    p6, p4, p4                ; clear SBE bits

sbe_off_offset = <sys__cbox_sbe_off_done - sys__cbox_sbe_off>

    hw_mtptr p4, EV6__I_CTL           ; (4,0L) write new i_ctl
    br     p6, sys__cbox_sbe_off

sys__cbox_sbe_off:
    addq   p6, #<sbe_off_offset+1>, p6 ; past stall in palmode
    bsr    r31, .                    ; stack push
    ALIGN_FETCH_BLOCK <^x47FF041F>; align
    hw_mtptr r31, EV6__IC_FLUSH       ; (4,0L) eliminate prefetches
    bne    r31, .                    ; pvc #24
    PVC_JSR sbe_off                   ; synch and flush
    hw_ret_stall (p6)                 ; use ret, pop stack
    PVC_JSR sbe_off, dest=1           ; br stops predictor
sys__cbox_sbe_off_done:
    br     r31, sys__cbox_touch1      ; now pull in the next block

ALIGN_CACHE_BLOCK
sys__cbox_over1:                      ; block 1
    addq   r31, #11, p6               ; initialize shift count (11x)
    addq   r31, r31, p7               ; initialize shift data
    br     r31, sys__cbox_over2       ; go to block 2
sys__cbox_touch1:                    ;
    br     r31, sys__cbox_touch2      ; touch block 2

sys__cbox_over2:                     ; block 2
    hw_mtptr r31, EV6__SHIFT_CONTROL ; (6,0L) shift in 6 bits
    subq   p6, #1, p6                 ; decrement shift count
    br     r31, sys__cbox_over3       ; go to block 3
sys__cbox_touch2:                   ;
    br     r31, sys__cbox_touch3      ; touch block 3

sys__cbox_over3:                    ; block 3
    hw_mtptr r31, <EV6__MM_STAT ! 64 > ; (6,0L) wait for shift
    bis    p5, #1, p5                 ; return in pal mode
    br     r31, sys__cbox_over4       ; go to block 4
sys__cbox_touch3:                   ;
    br     r31, sys__cbox_touch4      ; touch block 4

sys__cbox_over4:                    ; block 4
    hw_mfpr p4, EV6__DATA             ; (6,0L) read cbox data
    bis    r31, r31, r31              ; nop
    br     r31, sys__cbox_over5       ; go to block 5
sys__cbox_touch4:                   ;
    br     r31, sys__cbox_touch5      ; touch block 5

sys__cbox_over5:                    ; block 5
    and    p4, #^x3F, p4              ; clean to <5:0>
    addq   p4, p7, p7                 ; accumulate shift data
    br     r31, sys__cbox_over6       ; go to block 6
sys__cbox_touch5:                   ;
    br     r31, sys__cbox_touch6      ; touch block 6
```

Restriction 31 : I_CTL[VA_48] Update

```
sys__cbox_over6:                                ; block 6
    beq    p6, sys__cbox_over8                  ; branch if done
    bis    r31, r31, r31                        ; nop
    br     r31, sys__cbox_over7                ; go to block 7
sys__cbox_touch6:                               ;
    br     r31, sys__cbox_touch7              ; touch block 7

sys__cbox_over7:                               ; block 7
    bis    p7, r31, p20                        ; save before shifting
    sll    p7, #6, p7                          ; shift data 6 bits left
    br     r31, sys__cbox_over2                ; do next shift
sys__cbox_touch7:                             ;
    br     r31, sys__cbox_touch8              ; touch block 8

sys__cbox_over8:                               ; block 8
    beq    r31, sys__cbox_cbox_done            ; predict not taken
    PVC_VIOLATE <1006>
    br     r31, .-4                             ; predict back to infinite loop
    bis    r31, r31, r31                        ;
sys__cbox_touch8:                             ;
    br     r31, sys__cbox_over1                ; now start executing the shifts

sys__cbox_cbox_done:                          ; now restore i_ctl
    hw_mfpr p6, EV6__I_CTL                     ; (4,0L) get i_ctl
    lda    p4, <3@EV6__I_CTL__SBE__S>(r31)     ; sbe bits
    or     p6, p4, p4                          ; set SBE bits
    bis    r31, r31, r31

    hw_mtpr p4, EV6__I_CTL                     ; (4,0L) restore i_ctl

    PVC_JSR cbox, bsr=1, dest=1
    hw_ret_stall (p5)                          ; return to caller with stall
```

D.27 Restriction 31 : I_CTL[VA_48] Update

The VA_48 virtual address format cannot be changed while executing a JSR, JMP, GOTO, JSR_COROUTINE, or HW_RET instruction. A simple method of ensuring that the address does not change is to write I_CTL twice, in two separate fetch blocks, with the same data. The second write will stall the pipeline and ensure that the mode cannot change, even down a mispredicted path, while a following JSR type instruction might be using the address comparison logic.

D.28 Restriction 32 : PCTR_CTL Update

The performance counter must not be left in a state near overflow. If counting is disabled, the counters may produce multiple overflow signals if the counter output is not updated due to the counter being disabled. A repeated overflow signal with counters disabled can block other incoming interrupt requests while the overflow state persists. To avoid this situation, reads or writes to the counters should not leave a value near overflow. In normal operation, with counters enabled, a counter overflow will produce an overflow pulse, clear the counter, and produce a performance counter interrupt. Interrupts can only be blocked for one cycle.

D.29 Restriction 33 : HW_LD Physical/Lock Use

The HW_LD physical/lock instruction must be one of the first three instructions in a quad-instruction aligned fetch block. A pipeline error can occur if the HW_LD physical/lock is fetched as the fourth instruction of the fetch block.

D.30 Restriction 34 : Writing Multiple ITB Entries in the Same PAL-code Flow

Before a PALcode flow writes multiple ITB entries, additional scoreboard bits should be set to avoid possible corruption of the TAG IPR prior to final update in the ITB. The addition of scoreboard bits 0 and 4 to the standard scoreboard bit 6 for ITB_TAG will prevent subsequent HW_MTPR ITB_TAG writes from changing the staging register TAG value prior to retirement of the HW_MTPR ITB_PTE that triggers the final ITB update.

D.31 Guideline 35 : HW_INT_CLR Update

When writing the HW_INT_CLR IPR to clear interrupt requests, it may be necessary to write the same value twice in distinct fetch blocks to ensure that the interrupt request is cleared before exiting PALcode. A second write will cause a scoreboard stall until the first write retires, creating a convenient synchronization with the PALmode exit.

D.32 Restriction 36 : Updating I_CTL[SDE]

A software interlock is required between updates of the I_CTL[SDE] and a subsequent instruction fetch that may use any destination registers. A suggested method of ensuring this interlock is to use two MTPR I_CTL instructions in separate fetch blocks, followed by three more fetch blocks of non-NOP instructions.

D.33 Restriction 37 : Updating VA_CTL[VA_48]

A software interlock is required between updates of the VA_CTL[VA_48] and following LD or ST instructions. This is necessary since the VA_CTL update will not occur until the HW_MTPR VA_CTL instruction retires. A sufficient method of ensuring this interlock is to write the VA_CTL with the same data in two successive fetch blocks, causing a mapper stall. The dependant LD or ST instructions can be placed in any location of the second fetch block.

D.34 Restriction 38 : Updating PCTR_CTL

When updating the PCTR_CTL, it may be necessary to write the update value twice. If the counter being updated is currently disabled by way of the respective I_CTL or PCTX bits, the value must be written twice to ensure that the counter overflow is properly cleared. The overflow bit is conditionally latched using the same write enable as the counter update, so an additional write of the counter value will ensure that the overflow logic accurately reflects the addition of the new counter value plus the input conditions. The new update value must not be within one cycle of overflow (within 16 for SL0, within 4 for SL1) as required by Section D.28.

D.35 Guideline 39: Writing Multiple DTB Entries in the Same PAL Flow

If a PALcode flow intends to write multiple DTB entries (as would occur in a double miss), it must take care to keep subsequent HW_MTPR DTB_TAGx writes from corrupting the staging register TAG values prior to retirement of the HW_MTPR DTB_PTE_x, which triggers the final DTB update.

For example, in the double miss DTB flow, the following code could be used to hold up the return to the single miss flow (the numbers in parentheses are the scoreboard bits):

```
hw_mtptr r4, EV6__DTB_TAG0           ; (2&6) write tag0
hw_mtptr r4, EV6__DTB_TAG1           ; (1&5) write tag 1
hw_mtptr r5, EV6__DTB_PTE0           ; (0&4) write pte0
hw_mtptr r5, EV6__DTB_PTE1           ; (3&7) write pte1

bis r31, r31, r31                     ; force new fetch block
bis r31, r31, r31
bis r31, r31, r31
hw_mtptr r31, <EV6__MM_STAT ! ^x80>    ; (7) wait for pte write

hw_ret (r6)                           ; return to single miss
```

D.36 Restriction 40: Scrubbing a Single-Bit Error

On Bcache and Memory single bit errors on Icache fills, the hardware flushes the Icache, but the PALcode must scrub the block in the Bcache and memory. On Bcache and Memory single bit errors on Dcache fills, the hardware scrubs the Dcache as long as the error was on a target quadword, but the PALcode must scrub the Dcache for non-target quadwords, and must in general scrub the block in the Bcache and memory.

The scrub consists of reading each quadword in the block, with at least one exclusive access load/store to ensure the corrected data will be scrubbed in Bcache and memory. The scrub itself causes a CRD to be flagged, which is cleared by the PALcode before exiting to native mode.

```
; Sample code for scrubbing a single bit error.
;
; Since we only have the block address, and the hardware only corrects
;   target quadwords, we read each quadword.
; In order to ensure eviction to bcache and memory, a store
;   is needed to mark the block dirty. An exclusive access is
;   used to ensure we scrub in main memory. Virtual access is
;   used because of restrictions in use of hw_ld/hw_st lock
;   instructions.
; After the scrub, read the cbox chain again.
; The scrub will cause a crd, but will get cleared with a write
; to hw_int_clr.
;
; Current state:
;   r5                               base of crd logout frame
;
hw_ldq/p r4, MCHK_CRD__C_ADDR(r5)     ; get address back
bis r31, r31, r31
bis r31, r31, r31
bis r31, r31, r31
```

Restriction 40: Scrubbing a Single-Bit Error

```
hw_mtpr r31, EV6__DTB_IA           ; (7,1L) flush dtb
lda     r20, ^x3301(r31)           ; set WE, RE
bis     r31, r31, r31
bis     r31, r31, r31

hw_mtpr r31, <EV6__MM_STAT ! ^x80> ; wait for retire
srl     r4, #13, r6                ; shift byte offset
sll     r6, #EV6__DTB_PTE0__PFN__S, r6 ; shift into position
bis     r6, r20, r6                ; produce pte

hw_mtpr r4, EV6__DTB_TAG0          ; (2&6,0L) write tag0
hw_mtpr r4, EV6__DTB_TAG1          ; (1&5,1L) write tag1
hw_mtpr r6, EV6__DTB_PTE0          ; (0&4,0L) write pte0
hw_mtpr r6, EV6__DTB_PTE1          ; (3&7,1L) write pte1

mb                                           ; quiet before we start
bis     r31, r31, r31
bis     r31, r31, r31
bis     r31, r31, r31

ldq     r6, ^x00(r4)                 ; re-read the bad block QW #0
ldq     r6, ^x08(r4)                 ; re-read the bad block QW #1
ldq     r6, ^x10(r4)                 ; re-read the bad block QW #2
ldq     r6, ^x18(r4)                 ; re-read the bad block QW #3
ldq     r6, ^x20(r4)                 ; re-read the bad block QW #4
ldq     r6, ^x28(r4)                 ; re-read the bad block QW #5
ldq     r6, ^x30(r4)                 ; re-read the bad block QW #6
mb                                           ; no other mem-ops till done

ldq_l   r6, ^x38(r4)                 ; re-read the bad block QW #7
stq_c   r6, ^x38(r4)                 ; now store it to force scrub
mb
and     r6, r31, r6                  ; consumer of above

beq     r6, sys__crd_scrub_done      ; these 2 lines.....
br      r31, .-4                     ; .....stop pre-fetching
sys__crd_scrub_done:
bsr     r7, sys__cbox                ; clean the cbox error chain
bis     r31, r31, r31

hw_mtpr r31, EV6__DTB_IA           ; (7,1L) flush dtb
bis     r31, r31, r31
bis     r31, r31, r31
bis     r31, r31, r31

hw_mtpr r31, <EV6__MM_STAT ! ^x80> ; wait for retire
bis     r31, #1, r7                  ; get a 1
sll     r7, #EV6__HW_INT_CLR__CR__S, r7 ; shift into position
hw_mtpr r7, EV6__HW_INT_CLR         ; (4,0L) clear crd

lda     r7, EV6__DC_STAT_W1C_CRD(r31) ; W1C bits
hw_mtpr r7, EV6__DC_STAT            ; (6,0L)
bis     r31, r31, r31
bis     r31, r31, r31

hw_mtpr r31, <EV6__MM_STAT ! ^x50> ; stall till they retire
```

D.37 Restriction 41: MTPR ITB_TAG, MTPR ITB_PTE Must be in the Same Fetch Block

Write the ITB_TAG and ITB_PTE registers in the same fetch block. This avoids a mispredict path write of invalid data to the ITB_TAG register.

D.38 Restriction 42: Updating VA_CTL, CC_CTL, or CC IPRs

When writing to the VA_CTL, CC_CTL, or CC IPRs, write the same value twice in distinct fetch blocks. This ensures that the instruction is retired before any mispredict from a younger branch, DTB miss trap, or hw_ret_stall.

D.39 Restriction 43: No Trappable Instructions Along with HW_MTPR

There cannot be any mispredictable/trappable instructions together with an HW_MTPR in the current fetch block.

D.40 Restriction 44: Not Applicable to the 21264/EV68A

D.41 Restriction 45: No HW_JMP or JMP Instructions in PALcode

Do not include HW_JMP or JMP instructions in PALcode; use HW_RET instead.

HW_JMP always predicts in PALmode, and may mispredict to random cache blocks. This may cause speculative code to begin executing in PALmode and may have unexpected side effects such as I/O stream references.

HW_RET always predicts in native mode, and when it mispredicts, it avoids speculative execution in PALmode.

D.42 Restriction 46: Avoiding Livelocks in Speculative Load CRD Handlers

Speculative load CRD handlers that release from the interrupt without scrubbing a cache block could suffer from the following livelock condition:

1. An initial error on a speculative load forces a CRD interrupt.
2. The CRD releases without scrubbing the block. A speculative load in the shadow of the `hw_ret` (or `hw_ret_stall`) touches a Dcache location that has the single-bit error, forcing a CRD.
3. The CRD handler is entered again immediately.
4. Go to (2).

This problem can be avoided if all jumps in the CRD handler path for speculative loads use the following sequence:

```
mb                                     ; make sure hw_ret goes

ALIGN_FETCH_BLOCK <^x47FF041F>
mulq   p6, #1, p6                       ; Hold up loads
mulq   p6, #1, p6                       ; Hold up loads
hw_mtpr p6, <EV6_MM_STAT ! ^x44>       ; Hold up loads
PVC_VIOLATE<43>                         ; Ignore restriction 43
hw_ret_stall (p23)                      ; Return
```

This sequence prevents speculative loads from issuing in the shadow of the `hw_ret_stall`. Note that it is a violation of restriction 4 to have in the same fetch block a MTPR that specifies scoreboard bit 2 (an explicit writer in the memory operation group) and a `HW_RET` (an implicit reader in the memory operation group). Under normal circumstances, the intention would be for a `HW_RET` to wait until the MTPR issues, and that can only be enforced by putting the two instructions in different fetch blocks. In this case, the intention is for the `HW_RET` to issue *before* the MTPR. The hardware does not enforce the scoreboarding when the two instructions are in the same fetch block, and thus the `HW_RET` can issue and mispredict before any speculative loads (which are held up by the MTPR) can issue.

D.43 Restriction 47: Cache Eviction for Single-Bit Cache Errors

A live lock can occur if issuing instructions out-of-order causes a floating-point store instruction (with `sberr`) to replay trap.

A hardware mechanism exists that keeps track of replayed floating-point store instructions, and cancels the dirty register check. See Section D.5 for more details.

If the floating-point store instruction has an `sberr` and the `CRD_HANDLER` is entered/exited before the instruction is replayed, the mechanism will lose track of the instruction. When the instruction is replayed, the dirty register check is not canceled, and a replay trap occurs, causing the floating-point store instruction to continually replay the trap until the `sberr` is evicted from cache. The `sberr` will not evict, because the floating-point store instruction is killed by the replay trap. Killed instructions are not scrubbed by the Error Recovery Machine, and `CBOX_ERR[C_ADDR]` may not contain the address of the `sberr`. Because `CBOX_ERR[C_ADDR]` is not guaranteed, the `CRD_HANDLER` might not evict the `sberr`.

Restriction 47: Cache Eviction for Single-Bit Cache Errors

If "CBOX_ERR[C_ADDR]" has not changed when the CRD_HANDLER is re-entered, or "CBOX_ERR[C_STAT] == 0x0", all cache locations should to be evicted to avoid the live lock described above.

```
; Sample code for evicting cache.
; This method loads a 64K block, then exits the CRD_HANDLER
; to check if the sberr has been evicted. If not it loads the next 64K block.
; In the sample code below,
;   sx is a shadow register
;   ldi is a macro that loads a 64-bit constant into the specified register

full_scrub:
hw_ldq/p      s5, 104(r31)

        ldi    s1, ^x200                ; Loop dec value
        ldi    s2, ^x1C0                ; Start offset
        ldi    s3, ^x10000              ; Block size (64K -> size of dcache)
        ldi    s4, ^x2000000           ; 2X bcache size

        addq   s3, s5, s5
        ble   s5, s4, <.+4>            ; Skip next instruction if ADDR
                                                ; .le. 2X bcache

        bis    r31, r31, s5            ; Set ADDR = 0x0
        hw_stq/p s5, 104(r31)          ; Store ADDR for next pass thru
        subq   s5, s2, s5
        mb

        .align 4, NOP_OPCODE           ;
        blbc  r31, <.+4>                ;|
        br   r31, <.-4>                 ;|
        .align 4, NOP_OPCODE           ;N
                                                ; Make sure no speculative loads
                                                ; happen in the CRD handler

next_reread:
; ***** four cache blocks

        ; Evict dcache by prefetching to all dcache indexes.
        ; use 'hw_ldl r31 xxxx' Normal Prefetch
        ; Do not use 'hw_ldq/p r31 xxx' Prefetch,
        ; Evict Next because this will always access the same set in dcache.
        hw_ldl/p r31, ^x1C0(s5)         ; Re-read the bad block QW #0
        hw_ldl/p r31, ^x180(s5)         ; Re-read the bad block QW #0
        hw_ldl/p r31, ^x140(s5)         ; Re-read the bad block QW #0
        hw_ldl/p r31, ^x100(s5)         ; Re-read the bad block QW #0

        hw_ldl/p r31, ^xC0(s5)           ; Re-read the bad block QW #0
        hw_ldl/p r31, ^x80(s5)          ; Re-read the bad block QW #0
        hw_ldl/p r31, ^x40(s5)          ; Re-read the bad block QW #0
        hw_ldl/p r31, ^x00(s5)          ; Re-read the bad block QW #0

        subq   s5, s1, s5                ; Decrement addr
        subq   s3, s1, s3                ; Decrement counter
        ble   s3, <.+4>
        br   r31, next_reread
        bsr   s7, sys_cbox                ; Read and clean cbox error ipr
```

D.44 Restriction 48: MB Bracketing of Dcache Writes to Force Bad Data ECC and Force Bad Tag Parity

Writes to DC_CTL[F_BAD_DECC] and DC_CTL[DCDAT_ERR_EN] must be bracketed by MB instructions to quiesce the memory system. The Istream must also be quiesced before and during the sequence, as described in Section D.26.

21264/EV68A-to-Bcache Pin Interface

This appendix provides the pin interface between the 21264/EV68A and Bcache SSRAMs.

E.1 Forwarding Clock Pin Groupings

Table E-1 lists the correspondance between the clock signals for the 21264/EV68A and Bcache (late-write non-bursting and dual-data rate) SSRAMs.

Table E-1 Bcache Forwarding Clock Pin Groupings

Pad and Pin	Input Clock	Output Clocks
BcData_H[71:64,7:0]	BcDataInClk_H[0]	BcDataOutClk_x[0]
BcCheck_H[8,0]	BcDataInClk_H[0]	BcDataOutClk_x[0]
BcData_H[79:72,15:8]	BcDataInClk_H[1]	BcDataOutClk_x[0]
BcCheck_H[9,1]	BcDataInClk_H[1]	BcDataOutClk_x[0]
BcData_H[87:80,23:16]	BcDataInClk_H[2]	BcDataOutClk_x[1]
BcCheck_H[10,2]	BcDataInClk_H[2]	BcDataOutClk_x[1]
BcData_H[95:88,31:24]	BcDataInClk_H[3]	BcDataOutClk_x[1]
BcCheck_H[11,3]	BcDataInClk_H[3]	BcDataOutClk_x[1]
BcData_H[103:96,39:32]	BcDataInClk_H[4]	BcDataOutClk_x[2]
BcCheck_H[12,4]	BcDataInClk_H[4]	BcDataOutClk_x[2]
BcData_H[111:104,47:40]	BcDataInClk_H[5]	BcDataOutClk_x[2]
BcCheck_H[13,5]	BcDataInClk_H[5]	BcDataOutClk_x[2]
BcData_H[119:112,55:48]	BcDataInClk_H[6]	BcDataOutClk_x[3]
BcCheck_H[14,6]	BcDataInClk_H[6]	BcDataOutClk_x[3]
BcData_H[127:120,63:56]	BcDataInClk_H[7]	BcDataOutClk_x[3]
BcCheck_H[15,7]	BcDataInClk_H[7]	BcDataOutClk_x[3]
BcTag_H[42:20]	BcTagInClk_H	BcTagOutClk_x
BcTagParity_H	BcTagInClk_H	BcTagOutClk_x

Late-Write Non-Bursting SSRAMs

Table E–1 Bcache Forwarding Clock Pin Groupings (Continued)

Pad and Pin	Input Clock	Output Clocks
BcTagShared_H	BcTagInClk_H	BcTagOutClk_x
BcTagDirty_H	BcTagInClk_H	BcTagOutClk_x
BcTagValid_H	BcTagInClk_H	BcTagOutClk_x

E.2 Late-Write Non-Bursting SSRAMs

Table E–2 provides the data pin connections between late-write non-bursting SSRAMs and the 21264/EV68A or the system board. Table E–3 provides the same information for the tag pins.

Data Pin Usage

Table E–2 Late-Write Non-Bursting SSRAMs Data Pin Usage

21264/EV68A Signal Name or Board Connection	Late-Write SSRAM Data Pin Name
BcAdd_H[21:4]	SA_H[17:0]
BcDataOutClk_H[3:0]	CK_H
Set from board to 1/2 the 21264/EV68A core voltage	CK_L
BcData_H[127:0]/BcCheck_H[15:0]	DQ _x
BcDataWr_L	SW_L
Unconnected	Tck_H
Unconnected	Tdo_H
Unconnected	Tms_H
Unconnected	Tdi_H
From board, pull down to VSS	G_L
From board, pull down to VSS	SB _x _L
From board, pull down to VSS or BcDataOE_L	SS_L (Vendor dependent)

Tag Pin Usage

Unused Bcache tag pins should be pulled to ground through a 200-ohm resistor.

Table E–3 Late-Write Non-Bursting SSRAMs Tag Pin Usage

21264/EV68A Signal Name or Board Connection	Late-Write SSRAM Tag Pin Name
BcAdd_H[22:6]	SA_H[16:0]
BcTag_H[42:20]	DQ _x
BcTagOE_L or from board, pull down to VSS	SS_L (Vendor dependent)
BcTagWr_L	SW_L
From board, pull down to VSS	SB _x _L
BcTagOutClk_H	CK_H

Table E–3 Late-Write Non-Bursting SSRAMs Tag Pin Usage (Continued)

21264/EV68A Signal Name or Board Connection	Late-Write SSRAM Tag Pin Name
Set from board to 1/2 the 21264/EV68A core voltage	CK_L
Set from board to 1/2 the 21264/EV68A core voltage	VREF1_H VREF2_H
Set from board (implementation dependent)	ZQ_H
BcTagValid_H	DQ _x
BcTagDirty_H	DQ _x
BcTagShared_H	DQ _x
Unconnected	TMS_H
Unconnected	TDI_H
Unconnected	TCK_H
Unconnected	TDC_H

E.3 Dual-Data Rate SSRAMs

Table E–4 provides the data pin connections between dual-data rate SSRAMs and the 21264/EV68A or the system board. Table E–5 provides the same information for the tag pins.

Data Pin Usage

Table E–4 Dual-Data Rate SSRAM Data Pin Usage

21264/EV68A Signal Name or Board Connection	Dual-Data Rate SSRAM Data Pin Name
BcAdd_H[21:4]	SA_H[17:0]
BcData_H[33:20]/ BcCheck_H[15:0]	DQ _x
BcLoad_L	LD_L (B1)
BcDataWr_L	R/W_L(B2)
From board, pulled up to VDD	LBO_L
From board, pulled down to VSS	Q_L
BcDataInClk_H	CQ_H
BcDataOutClk_H	CK_H
BcDataOutClk_L	CK_L
Set from board to 1/2 the 21264/EV68A core voltage	VREF1_H VREF2_H
Set from board (implementation-dependent)	ZQ_H
Unconnected or terminated	CQ_L
From board, pulled up to VDD	TCK_H
Unconnected	TDO_H

Table E–4 Dual-Data Rate SSRAM Data Pin Usage (Continued)

21264/EV68A Signal Name or Board Connection	Dual-Data Rate SSRAM Data Pin Name
From board, pulled up to VDD	TMS_H
From board, pulled up to VDD	TDI_H
Unconnected or pulled down to VSS	TRST_L
BcDataOE_L	OE_L (G_L)
From board, pulled down to VSS	SD/DD_L (B3)

Tag Pin Usage

Unused Bcache tag pins should be pulled to ground through a 200-ohm resistor.

Table E–5 Dual-Data Rate SSRAM Tag Pin Usage

21264/EV68A Signal Name or Board Connection	Dual-Data Rate SSRAM Tag Pin Name
BcAdd_H[23:6]	SA_H[17:0]
BcTag_H[33:20]	DQ _x
BcTagOE_L	LD_L (B1)
BcTagWr_L	R/W_L (B2)
From board, pulled up to VDD	LBO_L
From board, pulled down to VSS	Q_L SA[19:18]
BcTagInClk_H	CQ_H
BcTagOutClk_H	CK_H
BcTagOutClk_L	CK_L
Set from board to 1/2 core voltage	VREF1_H VREF2_H
Set from board (implementation-dependent)	ZQ_H
BcTagValid_H	DQ _x
BcTagDirty_H	DQ _x
BcTagShared_H	DQ _x
BcTagParity_H	DQ _x
Unconnected or terminated	CQ_L
From board, pulled up to VDD	TCK_H
Unconnected	TDO_H
From board, pulled up to VDD	TMS_H
From board, pulled up to VDD	TDI_H

Table E–5 Dual-Data Rate SSRAM Tag Pin Usage (Continued)

21264/EV68A Signal Name or Board Connection	Dual-Data Rate SSRAM Tag Pin Name
Unconnected	TRST_L
From board, pulled down to VSS	OE_L (G_L)
From board, pulled up to VDD	SD/DD_L (B3)

Glossary

This glossary provides definitions for specific terms and acronyms associated with the Alpha 21264/EV68A microprocessor and chips in general.

abort

The unit stops the operation it is performing, without saving status, to perform some other operation.

address space number (ASN)

An optionally implemented register used to reduce the need for invalidation of cached address translations for process-specific addresses when a context switch occurs. ASNs are processor specific; the hardware makes no attempt to maintain coherency across multiple processors.

address translation

The process of mapping addresses from one address space to another.

ALIGNED

A datum of size 2^N is stored in memory at a byte address that is a multiple of 2^N (that is, one that has N low-order zeros).

ALU

Arithmetic logic unit.

ANSI

American National Standards Institute. An organization that develops and publishes standards for the computer industry.

ASIC

Application-specific integrated circuit.

ASM

Address space match.

ASN

See address space number.

assert

To cause a signal to change to its logical true state.

AST

See asynchronous system trap.

asynchronous system trap (AST)

A software-simulated interrupt to a user-defined routine. ASTs enable a user process to be notified asynchronously, with respect to that process, of the occurrence of a specific event. If a user process has defined an AST routine for an event, the system interrupts the process and executes the AST routine when that event occurs. When the AST routine exits, the system resumes execution of the process at the point where it was interrupted.

bandwidth

Bandwidth is often used to express the rate of data transfer in a bus or an I/O channel.

barrier transaction

A transaction on the external interface as a result of an MB (memory barrier) instruction.

Bcache

See second-level cache.

bidirectional

Flowing in two directions. The buses are bidirectional; they carry both input and output signals.

BiSI

Built-in self-initialization.

BiST

Built-in self-test.

bit

Binary digit. The smallest unit of data in a binary notation system, designated as 0 or 1.

bit time

The total time that a signal conveys a single valid piece of information (specified in ns). All data and commands are associated with a clock and the receiver's latch on both the rise and fall of the clock. Bit times are a multiple of the 21264/EV68A clocks. Systems must produce a bit time identical to 21264/EV68A's bit time. The bit time is one-half the period of the forwarding clock.

BIU

Bus interface unit. *See* Cbox.

Block exchange

Memory feature that improves bus bandwidth by paralleling a cache victim write-back with a cache miss fill.

board-level cache

See second-level cache.

boot

Short for bootstrap. Loading an operating system into memory is called booting.

BSR

Boundary-scan register.

buffer

An internal memory area used for temporary storage of data records during input or output operations.

bugcheck

A software condition, usually the response to software's detection of an "internal inconsistency," which results in the execution of the system bugcheck code.

bus

A group of signals that consists of many transmission lines or wires. It interconnects computer system components to provide communications paths for addresses, data, and control information.

byte

Eight contiguous bits starting on an addressable byte boundary. The bits are numbered right to left, 0 through 7.

byte granularity

Memory systems are said to have byte granularity if adjacent bytes can be written concurrently and independently by different processes or processors.

cache

See cache memory.

cache block

The smallest unit of storage that can be allocated or manipulated in a cache. Also known as a cache line.

cache coherence

Maintaining cache coherence requires that when a processor accesses data cached in another processor, it must not receive incorrect data and when cached data is modified, all other processors that access that data receive modified data. Schemes for maintaining consistency can be implemented in hardware or software. Also called cache consistency.

cache fill

An operation that loads an entire cache block by using multiple read cycles from main memory.

cache flush

An operation that marks all cache blocks as invalid.

cache hit

The status returned when a logic unit probes a cache memory and finds a valid cache entry at the probed address.

cache interference

The result of an operation that adversely affects the mechanisms and procedures used to keep frequently used items in a cache. Such interference may cause frequently used items to be removed from a cache or incur significant overhead operations to ensure correct results. Either action hampers performance.

cache line

See cache block.

cache line buffer

A buffer used to store a block of cache memory.

cache memory

A small, high-speed memory placed between slower main memory and the processor. A cache increases effective memory transfer rates and processor speed. It contains copies of data recently used by the processor and fetches several bytes of data from memory in anticipation that the processor will access the next sequential series of bytes. The 21264/EV68A microprocessor contains two onchip internal caches. See also write-through cache and write-back cache.

cache miss

The status returned when cache memory is probed with no valid cache entry at the probed address.

CALL_PAL instructions

Special instructions used to invoke PALcode.

Cbox

External cache and system interface unit. Controls the Bcache and the system ports.

central processing unit (CPU)

The unit of the computer that is responsible for interpreting and executing instructions.

CISC

Complex instruction set computing. An instruction set that consists of a large number of complex instructions. *Contrast with* RISC.

clean

In the cache of a system bus node, refers to a cache line that is valid but has not been written.

clock

A signal used to synchronize the circuits in a computer.

clock offset (or clkoffset)

The delay intentionally added to the forwarded clock to meet the setup and hold requirements at the Receive Flop.

CMOS

Complementary metal-oxide semiconductor. A silicon device formed by a process that combines PMOS and NMOS semiconductor material.

conditional branch instructions

Instructions that test a register for positive/negative or for zero/nonzero. They can also test integer registers for even/odd.

control and status register (CSR)

A device or controller register that resides in the processor's I/O space. The CSR initiates device activity and records its status.

CPI

Cycles per instruction.

CPU

See central processing unit.

CSR

See control and status register.

cycle

One clock interval.

data bus

A group of wires that carry data.

Dcache

Data cache. A cache reserved for storage of data. The Dcache does not contain instructions.

DDR

Dual-data rate. A dual-data rate SSRAM can provide data on both the rising and falling edges of the clock signal.

denormal

An IEEE floating-point bit pattern that represents a number whose magnitude lies between zero and the smallest finite number.

DIP

Dual inline package.

direct-mapping cache

A cache organization in which only one address comparison is needed to locate any data in the cache, because any block of main memory data can be placed in only one possible position in the cache.

direct memory access (DMA)

Access to memory by an I/O device that does not require processor intervention.

dirty

One status item for a cache block. The cache block is valid and has been written so that it may differ from the copy in system main memory.

dirty victim

Used in reference to a cache block in the cache of a system bus node. The cache block is valid but is about to be replaced due to a cache block resource conflict. The data must therefore be written to memory.

DMA

See direct memory access.

DRAM

Dynamic random-access memory. Read/write memory that must be refreshed (read from or written to) periodically to maintain the storage of information.

DTB

Data translation buffer. *Also defined as* Dstream translation buffer.

DTL

Diode-transistor logic.

dual issue

Two instructions are issued, in parallel, during the same microprocessor cycle. The instructions use different resources and so do not conflict.

ECC

Error correction code. Code and algorithms used by logic to facilitate error detection and correction. *See also* ECC error.

ECC error

An error detected by ECC logic, to indicate that data (or the protected “entity”) has been corrupted. The error may be correctable (soft error) or uncorrectable (hard error).

ECL

Emitter-coupled logic.

EEPROM

Electrically erasable programmable read-only memory. A memory device that can be byte-erased, written to, and read from. *Contrast with* FEPRM.

external cache

See second-level cache.

FEPROM

Flash-erasable programmable read-only memory. FEPROMs can be bank- or bulk-erased. *Contrast with EEPROM.*

FET

Field-effect transistor.

FEU

The unit within the 21264/EV68A microprocessor that performs floating-point calculations.

firmware

Machine instructions stored in nonvolatile memory.

floating point

A number system in which the position of the radix point is indicated by the exponent part and another part represents the significant digits or fractional part.

flush

See cache flush.

forwarded clock

A single-ended differential signal that is aligned with its associated fields. The forwarded clock is sourced and aligned by the sender with a period that is two times the bit time. Forwarded clocks must be 50% duty cycle clocks whose rising and falling edges are aligned with the changing edge of the data.

FPGA

Field-programmable gate array.

FPLA

Field-programmable logic array.

FQ

Floating-point issue queue.

framing clock

The framing clock defines the start of a transmission either from the system to the 21264/EV68A or from the 21264/EV68A to the system. The framing clock is a power-of-2 multiple of the 21264/EV68A **GCLK** frequency, and is usually the system clock. The framing clock and the input oscillator can have the same frequency. The `add_frame_select` IPR sets that ratio of bit times to framing clock. The frame clock could have a period that is four times the bit time with a `add_frame_select` of 2X. Transfers begin on the rising and falling edge of the frame clock. This is useful for systems that have system clocks with a period too small to perform the synchronous reset

of the clock forward logic. Additionally, the framing clock can have a period that is less than, equal to, or greater than the time it takes to send a full four cycle command/address.

GCLK

Global clock within the 21264/EV68A.

granularity

A characteristic of storage systems that defines the amount of data that can be read and/or written with a single instruction, or read and/or written independently.

hardware interrupt request (HIR)

An interrupt generated by a peripheral device.

high-impedance state

An electrical state of high resistance to current flow, which makes the device appear not physically connected to the circuit.

hit

See cache hit.

Icache

Instruction cache. A cache reserved for storage of instructions. One of the three areas of primary cache (located on the 21264/EV68A) used to store instructions. The Icache contains 8KB of memory space. It is a direct-mapped cache. Icache blocks, or lines, contain 32 bytes of instruction stream data with associated tag as well as a 6-bit ASM field and an 8-bit branch history field per block. Icache does not contain hardware for maintaining cache coherency with memory and is unaffected by the invalidate bus.

IDU

A logic unit within the 21264/EV68A microprocessor that fetches, decodes, and issues instructions. It also controls the microprocessor pipeline.

IEEE Standard 754

A set of formats and operations that apply to floating-point numbers. The formats cover 32-, 64-, and 80-bit operand sizes.

IEEE Standard 1149.1

A standard for the Test Access Port and Boundary Scan Architecture used in board-level manufacturing test procedures.

Inf

Infinity.

INT *nn*

The term INT nn , where nn is one of 2, 4, 8, 16, 32, or 64, refers to a data field size of nn contiguous NATURALLY ALIGNED bytes. For example, INT4 refers to a NATURALLY ALIGNED longword.

interface reset

A synchronously received reset signal that is used to preset and start the clock forwarding circuitry. During this reset, all forwarded clocks are stopped and the presettable count values are applied to the counters; then, some number of cycles later, the clocks are enabled and are free running.

Internal processor register (IPR)

Special registers that are used to configure options or report status.

IOWB

I/O write buffer.

IPGA

Interstitial pin grid array.

IQ

Integer issue queue.

ITB

Instruction translation buffer.

JFET

Junction field-effect transistor.

latency

The amount of time it takes the system to respond to an event.

LCC

Leadless chip carrier.

LFSR

Linear feedback shift register.

load/store architecture

A characteristic of a machine architecture where data items are first loaded into a processor register, operated on, and then stored back to memory. No operations on memory other than load and store are provided by the instruction set.

longword (LW)

Four contiguous bytes starting on an arbitrary byte boundary. The bits are numbered from right to left, 0 through 31.

LQ

Load queue.

LSB

Least significant bit.

machine check

An operating system action triggered by certain system hardware-detected errors that can be fatal to system operation. Once triggered, machine check handler software analyzes the error.

MAF

Miss address file.

main memory

The large memory, external to the microprocessor, used for holding most instruction code and data. Usually built from cost-effective DRAM memory chips. May be used in connection with the microprocessor's internal caches and an external cache.

masked write

A write cycle that only updates a subset of a nominal data block.

MBO

See must be one.

Mbox

This section of the processor unit performs address translation, interfaces to the Dcache, and performs several other functions.

MBZ

See must be zero.

MESI protocol

A cache consistency protocol with full support for multiprocessing. The MESI protocol consists of four states that define whether a block is modified (M), exclusive (E), shared (S), or invalid (I).

MIPS

Millions of instructions per second.

miss

See cache miss.

module

A board on which logic devices (such as transistors, resistors, and memory chips) are mounted and connected to perform a specific system function.

module-level cache

See second-level cache.

MOS

Metal-oxide semiconductor.

MOSFET

Metal-oxide semiconductor field-effect transistor.

MSI

Medium-scale integration.

multiprocessing

A processing method that replicates the sequential computer and interconnects the collection so that each processor can execute the same or a different program at the same time.

must be one (MBO)

A field that must be supplied as one.

must be zero (MBZ)

A field that is reserved and must be supplied as zero. If examined, it must be assumed to be UNDEFINED.

NaN

Not-a-Number. An IEEE floating-point bit pattern that represents something other than a number. This comes in two forms: signaling NaNs (for Alpha, those with an initial fraction bit of 0) and quiet NaNs (for Alpha, those with an initial fraction bit of 1).

NATURALLY ALIGNED

See ALIGNED.

NATURALLY ALIGNED data

Data stored in memory such that the address of the data is evenly divisible by the size of the data in bytes. For example, an ALIGNED longword is stored such that the address of the longword is evenly divisible by 4.

NMOS

N-type metal-oxide semiconductor.

NVRAM

Nonvolatile random-access memory.

OBL

Observability linear feedback shift register.

octaword

Sixteen contiguous bytes starting on an arbitrary byte boundary. The bits are numbered from right to left, 0 through 127.

OpenVMS Alpha operating system

The version of the open VMS operating system for Alpha platforms.

operand

The data or register upon which an operation is performed.

output mux counter

Counter used to select the output mux that drives address and data. It is reset with the Interface Reset and incremented by a copy of the locally generated forwarded clock.

PAL

Privileged architecture library. *See also* PALcode. *See also* Programmable array logic (hardware). A device that can be programmed by a process that blows individual fuses to create a circuit.

PALcode

Alpha privileged architecture library code, written to support Alpha microprocessors. PALcode implements architecturally defined behavior.

PALmode

A special environment for running PALcode routines.

parameter

A variable that is given a specific value that is passed to a program before execution.

parity

A method for checking the accuracy of data by calculating the sum of the number of ones in a piece of binary data. Even parity requires the correct sum to be an even number, odd parity requires the correct sum to be an odd number.

PGA

Pin grid array.

pipeline

A CPU design technique whereby multiple instructions are simultaneously overlapped in execution.

PLA

Programmable logic array.

PLCC

Plastic leadless chip carrier or plastic-leaded chip carrier.

PLD

Programmable logic device.

PLL

Phase-locked loop.

PMOS

P-type metal-oxide semiconductor.

PQ

Probe queue.

PQFP

Plastic quad flat pack.

primary cache

The cache that is the fastest and closest to the processor. The first-level caches, located on the CPU chip, composed of the Dcache and Icache.

program counter

That portion of the CPU that contains the virtual address of the next instruction to be executed. Most current CPUs implement the program counter (PC) as a register. This register may be visible to the programmer through the instruction set.

PROM

Programmable read-only memory.

pull-down resistor

A resistor placed between a signal line and a negative voltage.

pull-up resistor

A resistor placed between a signal line to a positive voltage.

QNaN

Quiet Nan. See NaN.

quad issue

Four instructions are issued, in parallel, during the same microprocessor cycle. The instructions use different resources and so do not conflict.

quadword

Eight contiguous bytes starting on an arbitrary byte boundary. The bits are numbered from right to left, 0 through 63.

RAM

Random-access memory.

RAS

Row address select.

RAW

Read-after-write.

READ_BLOCK

A transaction where the 21264/EV68A requests that an external logic unit fetch read data.

read data wrapping

System feature that reduces apparent memory latency by allowing read data cycles to differ the usual low-to-high sequence. Requires cooperation between the 21264/EV68A and external hardware.

read stream buffers

Arrangement whereby each memory module independently prefetches DRAM data prior to an actual read request for that data. Reduces average memory latency while improving total memory bandwidth.

receive counter

Counter used to enable the receive flops. It is clocked by the incoming forwarded clock and reset by the Interface Reset.

receive mux counter

The receive mux counter is preset to a selectable starting point and incremented by the locally generated forward clock.

register

A temporary storage or control location in hardware logic.

reliability

The probability a device or system will not fail to perform its intended functions during a specified time interval when operated under stated conditions.

reset

An action that causes a logic unit to interrupt the task it is performing and go to its initialized state.

RISC

Reduced instruction set computing. A computer with an instruction set that is paired down and reduced in complexity so that most can be performed in a single processor cycle. High-level compilers synthesize the more complex, least frequently used instructions by breaking them down into simpler instructions. This approach allows the RISC architecture to implement a small, hardware-assisted instruction set, thus eliminating the need for microcode.

ROM

Read-only memory.

RTL

Register-transfer logic.

SAM

Serial access memory.

SBO

Should be one.

SBZ

Should be zero.

scheduling

The process of ordering instruction execution to obtain optimum performance.

SDRAM

Synchronous dynamic random-access memory.

second-level cache

A cache memory provided outside of the microprocessor chip, usually located on the same module. Also called board-level, external, or module-level cache.

set-associative

A form of cache organization in which the location of a data block in main memory constrains, but does not completely determine, its location in the cache. Set-associative organization is a compromise between direct-mapped organization, in which data from a given address in main memory has only one possible cache location, and fully associative organization, in which data from anywhere in main memory can be put anywhere in the cache. An “ n -way set-associative” cache allows data from a given address in main memory to be cached in any of n locations.

SIMM

Single inline memory module.

SIP

Single inline package.

SIPP

Single inline pin package.

SMD

Surface mount device.

SNaN

Signaling NaN. *See* Nan.

SRAM

See SSRAM.

SROM

Serial read-only memory.

SSI

Small-scale integration.

SSRAM

Synchronous static random-access memory.

stack

An area of memory set aside for temporary data storage or for procedure and interrupt service linkages. A stack uses the last-in/first-out concept. As items are added to (pushed on) the stack, the stack pointer decrements. As items are retrieved from (popped off) the stack, the stack pointer increments.

STRAM

Self-timed random-access memory.

superpipelined

Describes a pipelined machine that has a larger number of pipe stages and more complex scheduling and control. *See also* pipeline.

superscalar

Describes a machine architecture that allows multiple independent instructions to be issued in parallel during a given clock cycle.

system clock

The primary skew controlled clock used throughout the interface components to clock transfer between ASICs, main memory, and I/O bridges.

tag

The part of a cache block that holds the address information used to determine if a memory operation is a hit or a miss on that cache block.

target clock

Skew controlled clock that receives the output of the RECEIVE MUX.

TB

Translation buffer.

tristate

Refers to a bused line that has three states: high, low, and high-impedance.

TTL

Transistor-transistor logic.

UART

Universal asynchronous receiver-transmitter.

UNALIGNED

A datum of size $2 \times N$ stored at a byte address that is not a multiple of $2 \times N$.

unconditional branch instructions

Instructions that change the flow of program control without regard to any condition. *Contrast with* conditional branch instructions.

UNDEFINED

An operation that may halt the processor or cause it to lose information. Only privileged software (that is, software running in kernel mode) can trigger an UNDEFINED operation. (This meaning only applies when the word is written in all upper case.)

UNPREDICTABLE

Results or occurrences that do not disrupt the basic operation of the processor; the processor continues to execute instructions in its normal manner. Privileged or unprivileged software can trigger UNPREDICTABLE results or occurrences. (This meaning only applies when the word is written in all upper case.)

UVPROM

Ultraviolet (erasable) programmable read-only memory.

VAF

See victim address file.

valid

Allocated. Valid cache blocks have been loaded with data and may return cache hits when accessed.

VDF

See victim data file.

VHSIC

Very-high-speed integrated circuit.

victim

Used in reference to a cache block in the cache of a system bus node. The cache block is valid but is about to be replaced due to a cache block resource conflict.

victim address file

The victim address file and the victim data file, together, form an 8-entry buffer used to hold information for transactions to the Bcache and main memory.

victim data file

The victim address file and the victim data file, together, form an 8-entry buffer used to hold information for transactions to the Bcache and main memory.

virtual cache

A cache that is addressed with virtual addresses. The tag of the cache is a virtual address. This process allows direct addressing of the cache without having to go through the translation buffer making cache hit times faster.

VLSI

Very-large-scale integration.

VPC

Virtual program counter.

VRAM

Video random-access memory.

WAR

Write-after-read.

word

Two contiguous bytes (16 bits) starting on an arbitrary byte boundary. The bits are numbered from right to left, 0 through 15.

write-back

A cache management technique in which write operation data is written into cache but is not written into main memory in the same operation. This may result in temporary differences between cache data and main memory data. Some logic unit must maintain coherency between cache and main memory.

write-back cache

Copies are kept of any data in the region; read and write operations may use the copies, and write operations use additional state to determine whether there are other copies to invalidate or update.

WRITE_BLOCK

A transaction where the 21264/EV68A requests that an external logic unit process write data.

write data wrapping

System feature that reduces apparent memory latency by allowing write data cycles to differ the usual low-to-high sequence. Requires cooperation between the 21264/EV68A and external hardware.

write-through cache

A cache management technique in which a write operation to cache also causes the same data to be written in main memory during the same operation. Copies are kept of any data in a region; read operations may use the copies, but write operations update the actual data location and either update or invalidate all copies.

Numerics

21264/EV68A, features of, 1–3

32_BYTE_IO Cbox CSR
defined, 5–34

A

Abbreviations, xix

binary multiples, xix
register access, xix

AC characteristics, 9–6

Address conventions, xx

Aggregate mode, 6–18

Aligned convention, xx

Alpha instruction summary, A–1

AMASK instruction values, 2–37

ARITH synchronous trap, 6–14

B

B_DA_OD pin type, 3–3, 9–2
values for, 9–4

B_DA_PP pin type, 3–3, 9–2
values for, 9–4

BC_BANK_ENABLE Cbox CSR, 4–51, 5–39,
7–13

BC_BPHASE_LD_VECTOR Cbox CSR, 4–45
defined, 5–38

BC_BURST_MODE_ENABLE Cbox CSR, 4–51
defined, 5–35

BC_CLEAN_VICTIM Cbox CSR, 4–23
defined, 5–34

BC_CLK_DELAY Cbox CSR, 4–45
defined, 5–35

BC_CLK_LD_VECTOR Cbox CSR, 4–45
defined, 5–38

BC_CLKFWD_ENABLE Cbox CSR, 4–47
defined, 5–36

BC_CLOCK_OUT Cbox CSR, 4–45

BC_CPU_CLK_DELAY Cbox CSR, 4–44, 4–45
defined, 5–38

BC_CPU_LATE_WRITE_NUM Cbox CSR
defined, 5–35

BC_DDM_FALL_EN Cbox CSR, 4–47
defined, 5–36

BC_DDM_RISE_EN Cbox CSR, 4–47
defined, 5–36

BC_DDMF_ENABLE Cbox CSR, 4–47
defined, 5–35

BC_DDMR_ENABLE Cbox CSR, 4–47
defined, 5–35

BC_ENABLE Cbox CSR, 4–51, 5–39, 7–12

BC_FDBK_EN Cbox CSR, 4–46
defined, 5–38

BC_FRM_CLK Cbox CSR, 4–47
defined, 5–35

BC_LAT_DATA_PATTERN Cbox CSR, 4–48
defined, 5–35

BC_LAT_TAG_PATTERN Cbox CSR, 4–48
defined, 5–35

BC_LATE_WRITE_NUM Cbox CSR, 4–49
defined, 5–35

BC_LATE_WRITE_UPPER Cbox CSR
defined, 5–35

BC_PENTIUM_MODE Cbox CSR, 4–51
defined, 5–35

BC_PERR error status in C_STAT, 5–42

BC_RCV_MUX_CNT_PRESET Cbox CSR
defined, 5–36

BC_RCV_MUX_PRESET_CNT Cbox CSR, 4–48

BC_RD_RD_BUBBLE Cbox CSR
defined, 5–34

BC_RD_WR_BUBBLES Cbox CSR, 4–49
defined, 5–34

BC_RDVICTIM Cbox CSR, 4–23, 4–26
defined, 5–34

BC_SIZE Cbox CSR, 4–51, 5–39, 7–12

BC_SJ_BANK_ENABLE Cbox CSR
 defined, 5–34

BC_TAG_DDM_FALL_EN Cbox CSR, 4–47
 defined, 5–36

BC_TAG_DDM_RISE_EN Cbox CSR, 4–47
 defined, 5–36

BC_WR_RD_BUBBLES Cbox CSR, 4–49
 defined, 5–35

BC_WR_WR_BUBBLE Cbox CSR, 4–53
 defined, 5–34

BC_WRT_STS Cbox CSR, 5–39, 7–13

Bcache

- banking, 4–53
- bubbles on the data bus, 4–49
- clocking, 4–44
- control pins, 4–51
- data read transactions, 4–47
- data single-bit correctable ECC error, 8–5
- data single-bit correctable ECC error on a probe, 8–9
- data write transactions, 4–48
- error case summary for, 8–10
- filling Dcache error, 8–6
- filling Icache error, 8–5
- forwarding clock pin groupings, E–1
- maximum clock ratio, 4–42
- port, 4–42
- port pins, 4–43
- programming the size of, 4–51
- setting clock period, 4–45
- structure of, 4–7
- tag parity errors, 8–5
- tag read transactions, 4–47
- victim read during an ECB instruction error, 8–7
- victim read during Dcache/Bcache miss error, 8–7
- victim read error, 8–7

BcAdd_H signal pins, 3–3, 4–43
 characteristics, 4–51

BcCheck_H signal pins, 3–3, 4–43

BcData_H signal pins, 3–3, 4–43

BcDataInClk_H signal pins, 3–3, 4–43
 using, 4–53

BcDataOE_L signal pin, 3–3, 4–43

BcDataOutClk_x signal pins, 3–4, 4–43

BcDataWr_L signal pin, 3–4, 4–44

BcLoad_L signal pin, 3–4, 4–44

BcTag_H signal pins, 3–4, 4–44

BcTagDirty_H signal pin, 3–4, 4–44

BcTagInClk_H signal pin, 3–4, 4–44
 using, 4–53

BcTagOE_L signal pin, 3–4, 4–44

BcTagOutClk_x signal pins, 3–4, 4–44

BcTagParity_H signal pin, 3–4, 4–44

BcTagShared_H signal pin, 3–4, 4–44

BcTagValid_H signal pin, 3–4, 4–44

BcTagWr_L signal pin, 3–4, 4–44

BcVref signal pin, 3–4, 4–44

Bidirectional differential amplifier receiver - open-drain. See B_DA_OD

Bidirectional differential amplifier receiver - push-pull. See B_DA_PP

Binary multiple abbreviations, xix

BiST. See Built-in self-test

Bit notation conventions, xx

Boulder-scan register, B–1

Branch history table, initialized by BiST, 7–12

Branch misprediction, pipeline abort delay from, 2–16

Branch predictor, 2–3

BSDL description of the boundary-scan register, B–1

Built-in self-test, 11–5
 load, 7–6

C

C_ADDR Cbox read register field, 5–42

C_DATA Cbox data register, 5–33
 at power-on reset state, 7–16

C_SHFT Cbox shift register, 5–33
 at power-on reset state, 7–16

C_STAT Cbox read register field, 5–42

C_STS Cbox read register field, 5–42

C_SYNDROME_0 Cbox read register field, 5–41

C_SYNDROME_1 Cbox read register field, 5–41

Cache block states, 4–9
 response to 21264/EV68A commands, 4–10
 transitions, 4–10

Cache coherency, 4–8

CALL_PAL entry points, 6–12

Caution convention, xx

Cbox

- data register C_DATA, 5–33
 - described, 2–11, 4–3
 - duplicate Dcache tag array, 2–11
 - duplicate Dcache tag array with, 4–13
 - HW_MTPR and HW_MFPR to CSR, D–15
 - I/O write buffer, 2–11
 - internal processor registers, 5–3
 - probe queue, 2–11
 - read register, 5–41
 - shift register C_SHFT, 5–33
 - victim address file, 2–11
 - WRITE_MANY chain, 5–38
 - WRITE_MANY chain example, 5–39
 - WRITE_ONCE chain, 5–33
- CC cycle counter register, 5–3
- at power-on reset state, 7–15
- CC_CTL cycle counter control register, 5–3
- at power-on reset state, 7–15
- CFR_EV6CLK_DELAY Cbox CSR, defined, 5–38
- CFR_FRMCLK_DELAY Cbox CSR, defined, 5–38
- CFR_GCLK_DELAY Cbox CSR, defined, 5–38
- ChangeToDirtyFail, SysDc command, 4–10, 4–11, 4–12
- ChangeToDirtySuccess, SysDc command, 4–10, 4–11, 4–12
- Choice predictor, 2–5
- ChxToDirty, 21264/EV68A command, 4–12
- CLAMP public instruction, B–1
- Clean cache block state, 4–9
- Clean/Shared cache block state, 4–10
- CleanToDirty, 21264/EV68A command, 4–22, 4–40
- system probes, with, 4–41
- CleanVictimBlk, 21264/EV68A command, 4–22, 4–39
- ClkFwdRst_H signal pin, 3–4, 4–30
- with system initialization, 7–7
- ClkIn_x signal pins, 3–4
- Clock forwarding, 7–4
- CLR_MAP clear virtual-to-physical map register, 5–21
- at power-on reset state, 7–15
- CMOV instruction, special cases of, 2–26
- COLD reset machine state, 7–17
- Commands
- 21264/EV68A to system, 4–19
 - system to 21264/EV68A, 4–26
 - when to NXM, 4–38

Conventions, xix

- abbreviations, xix
 - address, xx
 - aligned, xx
 - bit notation, xx
 - caution, xx
 - data units, xxi
 - do not care, xxi
 - external, xxi
 - field notation, xxi
 - note, xxi
 - numbering, xxi
 - ranges and extents, xxi
 - register figures, xxi
 - signal names, xxi
 - unaligned, xx
 - X, xxi
- CTAG, 4–13

D

Data cache. See Dcache

Data merging

- load instructions in I/O address space, 2–28
- store instructions in I/O address space, 2–29

Data transfer commands, system, 4–28

Data types

- floating point support, 1–2
- integer supported, 1–2
- supported, 1–1

Data units convention, xxi

Data wrap, 4–36

- double-pumped, 4–38
- interleaved, 4–37

DATA_VALID_DLY Cbox CSR, defined, 5–38

dc

- characteristics of, 9–2
- input pin capacitance defined, 9–2
- test load defined, 9–2

DC_CTL Dcache control register, 5–30

- at power-on reset state, 7–16
- error correction and, 8–2

DC_PERR error status in C_STAT, 5–42

DC_STAT Dcache status register, 5–31

- at power-on reset state, 7–16

Dcache

- described, 2–12
- duplicate tag parity errors, 8–4
- duplicate tags with, 4–13
- error case summary for, 8–10
- fill from Bcache error, 8–6
- fill from memory errors, 8–8
- initialized by BiST, 7–12
- pipelined, 2–16
- single-bit correctable ECC error, 8–3
- store second error, 8–4
- tag parity errors, 8–2
- victim extracts, 8–4

Dcache data single-bit correctable ECC errors, 8–3

Dcache tag, initialized by BiST, 7–12

DCOK_H signal pin, 3–4

- power-on reset flow, 7–1

DCVIC_THRESHOLD Cbox CSR, defined, 5–34

DFAULT fault, 6–13

Differential 21264/EV68A clocks, 7–19

Differential reference clocks, 7–19

Dirty cache block state, 4–10

Dirty/Shared cache block state, 4–10

Do not care convention, xxi

Double-bit fill errors, 8–9

DOWN1 reset machine state, 7–18

DOWN2 reset machine state, 7–19

DOWN3 reset machine state, 7–19

Dstream translation buffer, 2–13

- See also DTB

DSTREAM_BC_DBL error status in C_STAT, 5–42

DSTREAM_BC_ERR error status in C_STAT, 5–42

DSTREAM_DC_ERR error status in C_STAT, 5–42

DSTREAM_MEM_DBL error status in C_STAT, 5–42

DSTREAM_MEM_ERR error status in C_STAT, 5–42

DTAG. See Duplicate Dcache tag array

DTB entries, writing multiple in same PAL flow, D–19

DTB fill, 6–14

DTB, pipeline abort delay with, 2–16

DTB_ALTMODE alternate processor mode register, 5–26

- at power-on reset state, 7–15

DTB_ASN0 address space number register 0

- at power-on reset state, 7–16

DTB_ASN0 address space number registers 0, 5–28

DTB_ASN1 address space number register 1, 5–28

- at power-on reset state, 7–16

DTB_IA invalidate-all process register, 5–27

- at power-on reset state, 7–15

DTB_IAP invalidate-all (ASM=0) process register, 5–27

- at power-on reset state, 7–15

DTB_IS0 invalidate single (array 0) register, 5–27

- at power-on reset state, 7–16

DTB_IS1 invalidate single (array 1) register, 5–27

- at power-on reset state, 7–16

DTB_PTE0 array write 0 register

- at power-on reset state, 7–15
- MTPR to, D–12

DTB_PTE0 array write register 0, 5–26

DTB_PTE1 array write 1 register, 5–26

- at power-on reset state, 7–15
- MTPR to, D–12

DTB_TAG0 array write 0 register, 5–25

- at power-on reset state, 7–15
- MTPR to, D–12

DTB_TAG1 array write 1 register, 5–25

- at power-on reset state, 7–15
- MTPR to, D–12

DTBM_DOUBLE_3 fault, 6–13

DTBM_DOUBLE_4 fault, 6–13

DTBM_SINGLE fault, 6–13

Dual-data rate SSRAM pin assignments, E–3

DUP_TAG_ENABLE Cbox CSR, defined, 5–34

Duplicate Dcache tag array, 2–11

Duplicate Dcache, initialized by BiST, 7–12

Duplicate tag array, Cbox copy. See CTAG

Duplicate tag stores, Bcache, 4–7

E

Ebox

- cycle counter control register CC_CTL, 5–3
- cycle counter register CC, 5–3
- described, 2–8
- executed in pipeline, 2–16
- internal processor registers, 5–1
- slotting, 2–18
- subclusters, 2–18
- virtual address control register VA_CTL, 5–4
- virtual address format register VA_FORM, 5–5
- virtual address register, 5–4

ECB instruction, external interface reference, 4–5

ECC
 64-bit data and check bit code, 8–2
 Dcache data single-bit correctable errors, 8–3
 for system data bus, 8–2
 memory/system port single-bit correctable errors, 8–7
 store instructions, 8–4

ENABLE_EVICT Cbox CSR, 4–23, 5–39

ENABLE_PROBE_CHECK Cbox CSR, 8–2
 defined, 5–35

ENABLE_STC_COMMAND Cbox CSR, defined, 5–35

Energy star certification, 7–9

Error case summary, 8–10

Error correction code. See ECC

Error detection mechanisms, 8–1

EV6Clk_x signal pins, 3–4

Evict, 21264/EV68A command, 4–13, 4–22, 4–39

EVICT_ENABLE Cbox CSR, 7–13

EXC_ADDR exception address register, 5–8
 after fault reset, 7–8
 at power-on reset state, 7–15

EXC_SUM exception summary register, 5–13
 at power-on reset state, 7–15

Exception and interrupt logic, 2–8

Exception condition summary, A–15

External cache and system interface unit. See Cbox

External convention, xxi

External interface initialization, 7–14

EXTEST public instruction, B–1

F

F31
 load instructions with, 2–23
 retire instructions with, 2–22

Fast data disable mode, 4–33

Fast data mode, 4–30, 4–31

FAST_MODE_DISABLE Cbox CSR, 4–30
 defined, 5–34

Fault reset flow, 7–8

Fault reset sequence of operations, 7–9

FAULT_RESET reset machine state, 7–18

Fbox
 described, 2–10
 executed in pipeline, 2–16

FEN fault, 6–13

FetchBlk, 21264/EV68A command, 4–22, 4–39
 system probes, with, 4–41

FetchBlkSpec, 21264/EV68A command, 4–22,
 4–39

Field notation convention, xxi

Floating-point arithmetic trap, pipeline abort delay
 with, 2–16

Floating-point control register, 2–35
 PALcode emulation of, 6–11

Floating-point execution unit. See Fbox

Floating-point instructions
 IEEE, A–9
 independent, A–11
 VAX, A–11

Floating-point issue queue, 2–7

Forwarding clock pin groupings, E–1

FPCR. See Floating-point control register

FQ. See Floating-point issue queue

FrameClk_x signal pins, 3–5, 4–30

G

GCLK, 7–19

Global predictor, 2–4

H

Heat sink center temperature, 10–1

Heat sink specifications, 10–3

HW_INT_CLR hardware interrupt clear register,
 5–12
 at power-on reset state, 7–15
 updating, D–18

HW_LD PALcode instruction, 6–3, A–9, D–18

HW_MFPR PALcode instruction, 6–6, A–9

HW_MTPR PALcode instruction, 6–6, A–9

HW_REI PALcode instruction, A–9

HW_RET PALcode instruction, 6–5

HW_ST PALcode instruction, 6–4, A–9

I

I/O address space
 instruction data merging, 2–29
 load instruction data merging, 2–28
 load instructions with, 2–27
 store instructions with, 2–29

I/O write buffer, 2–11
 defined, 2–32

- I_CTL Ibox control register, 5–15
 - after fault reset, 7–8
 - after warm reset, 7–11
 - at power-on reset state, 7–15
 - PALshadow registers, 6–11
 - through sleep mode, 7–10
 - VA_48 field update, D–17
- I_DA pin type, 3–3, 9–2
 - values for, 9–3
- I_DA_CLK pin type, 3–3, 9–2
 - values for, 9–3
- I_DC_POWER pin type, 9–2
- I_DC_REF pin type, 3–3, 9–2
 - values for, 9–3
- I_STAT Ibox status register, 5–18
 - at power-on reset state, 7–15
- IACV fault, 6–13
- Ibox
 - branch predictor, 2–3
 - clear virtual-to-physical map register
 - CLR_MAP, 5–21
 - exception address register EXC_ADDR, 5–8
 - exception and interrupt logic, 2–8
 - exception summary register EXC_SUM, 5–13
 - floating-point issue queue, 2–7
 - hardware interrupt clear register HW_INT_CLR, 5–12
 - Ibox control register I_CTL, 5–15
 - Ibox process context register PCTX, 5–21
 - Ibox status register I_STAT, 5–18
 - Icache flush ASM register IC_FLUSH_ASM, 5–21
 - Icache flush register IC_FLUSH, 5–21
 - instruction fetch logic, 2–6
 - instruction virtual address format register
 - IVA_FORM, 5–9
 - instruction-stream translation buffer, 2–5
 - integer issue queue, 2–6
 - internal processor registers, 5–1
 - interrupt enable and current processor mode register IER_CM, 5–9
 - interrupt summary register ISUM, 5–11
 - ITB invalidate single register ITB_IS, 5–7
 - ITB invalidate-all ASM (ASM=0) register
 - ITB_IAP, 5–7
 - ITB invalidate-all register ITB_IA, 5–7
 - ITB PTE array write register ITB_PTE, 5–6
 - ITB tag array write register ITB_TAG, 5–6
 - PAL base register PAL_BASE, 5–15
 - performance counter control register
 - PCTR_CTL, 5–23
 - ProfileMe register PMPC, 5–8
 - register rename maps, 2–6
 - retire logic, 2–8
 - retire logic and mapper, required sequence for, D–1
 - sleep mode register SLEEP, 5–21
 - software interrupt request register SIRR, 5–10
 - subsections in, 2–2
 - virtual program counter logic, 2–2
- IC_FLUSH Icache flush register
 - at power-on reset state, 7–15
- IC_FLUSH_ASM Icache flush ASM register, 5–21
- Icache
 - data errors, 8–2
 - error case summary for, 8–10
 - fill from Bcache error, 8–5
 - fill from memory error, 8–7
 - flush register IC_FLUSH, 5–21
 - initialized by BiST, 7–12
 - tag, initialized by BiST, 7–12
- IEEE 1149.1
 - notes for compliance to, 11–7
 - test port reset, 7–16
 - test port, operation of, 11–3
- IEEE floating-point conformance, A–14
- IEEE floating-point instruction opcodes, A–9
- IER_CM interrupt enable and current processor mode register, 5–9
 - at power-on reset state, 7–15
- IMPLVER instruction values, 2–38
- Independent floating-point function codes, A–11
- INIT_MODE Cbox CSR, 5–39, 7–12
- Initialization mode processing, 7–12
- Input dc reference pin. See I_DC_REF pin type
- Input differential amplifier clock receiver. See I_DA_CLK pin type
- Input differential amplifier receiver. See I_DA pin type
- Instruction fetch logic, 2–6
- Instruction fetch, issue, and retire unit. See Ibox
- Instruction fetch, pipelined, 2–14
- Instruction issue rules, 2–16
- Instruction latencies, pipelined, 2–20
- Instruction ordering, 2–30
- Instruction retire latencies, minimum, 2–21
- Instruction retire rules
 - F31, 2–22
 - floating-point divide, 2–22
 - floating-point square root, 2–22
 - pipelined, 2–21
 - R31, 2–22
- Instruction slot, pipelined, 2–14
- Instruction-stream translation buffer, 2–5
- Int_Add_BcClk internal forwarded clock, 4–44, 4–48
- Int_Data_BcClk internal forwarded clock, 4–44, 4–49
- INT_FWD_CLK clock queue, 4–30
- Integer arithmetic trap, pipeline abort delay with,

2-16

Integer execution unit. See Ebox

Integer issue queue, 2-6
 pipelined, 2-15

Internal processor registers, 5-1
 accessing, 6-7
 explicitly written, 6-8
 implicitly written, 6-9
 ordering access, 6-9
 paired fetch order, 6-9
 scoreboard bits for, 6-8

INTERRUPT interrupt, 6-14

INVAL_TO_DIRTY Cbox CSR, 4-23
 programming, 4-23

INVAL_TO_DIRTY_ENABLE Cbox CSR, 5-39,
 7-12

InvalToDirty, 21264/EV68A command, 4-12,
 4-22, 4-40
 system probes, with, 4-41

InvalToDirtyVic, 21264/EV68A command, 4-22,
 4-40

IOWB. See I/O write buffer

IPRs. See Internal processor registers

IQ. See Integer issue queue

IRQ_H signal pins, 3-5

Istream, 2-5

Istream memory references
 translation to external references, 4-5

ISTREAM_BC_DBL error status in C_STAT, 5-42

ISTREAM_BC_ERR error status in C_STAT, 5-42

ISTREAM_MEM_DBL error status in C_STAT,
 5-42

ISTREAM_MEM_ERR error status in C_STAT,
 5-42

ISUM interrupt summary register, 5-11
 at power-on reset state, 7-15

ITB, 2-5

ITB fill, 6-16

ITB miss, pipeline abort delay with, 2-16

ITB_IA invalidate-all register, 5-7
 at power-on reset state, 7-15

ITB_IAP invalidate-all (ASM=0) register, 5-7
 at power-on reset state, 7-15

ITB_IS invalidate single register, 5-7
 at power-on reset state, 7-15

ITB_MISS fault, 6-14

ITB_PTE array write register, 5-6
 at power-on reset state, 7-14

ITB_TAG array write register, 5-6
 at power-on reset state, 7-14

IVA_FORM instruction virtual address format
 register, 5-9
 at power-on reset state, 7-15

J

JITTER_CMD Cbox CSR, defined, 5-38

JMP misprediction, in PALcode, D-15

JSR misprediction
 in PALcode, D-15
 pipeline abort delay with, 2-16

JSR_COR misprediction, in PALcode, D-15

Junction temperature, 9-1

L

Late-write non-bursting SSRAM pin assignments,
 E-2

LDBU instruction, normal prefetch with, 2-23

LDF instruction, normal prefetch with, 2-23

LDG instruction, normal prefetch with, 2-23

LDQ instruction, prefetch with evict next, 2-24

LDS instruction, prefetch with modify intent, 2-23

LDT instruction, normal prefetch with, 2-23

LDWU instruction, normal prefetch with, 2-23

LDX_L instructions
 in-order processing for, 4-15
 locking mechanism for, 4-14

Load hit speculation, 2-24

Load instructions
 ECC with, 8-3
 I/O reference ordering, 2-31
 Mbox order traps, 2-31
 memory reference ordering, 2-30
 translation to external interface, 4-5

Load queue, described, 2-13

Load-load order trap, 2-31

Local predictor, 2-4

Lock mechanism, 4-14

Logic symbol, the 21264/EV68A, 3-2

LQ. See Load queue

M

M_CTL Mbox control register, 5-29
 at power-on reset state, 7-16

MAF. See Miss address file

MB instruction processing, 2-33

MB, 21264/EV68A command, 4–13, 4–21

MB_CNT Cbox CSR, operation, 2–32

MBDone, SysDc command, 4–13

Mbox

- Dcache control register DC_CTL, 5–30
- Dcache status register DC_STAT, 5–31
- described, 2–12
- Dstream translation buffer, 2–13
- DTB address space number registers 0 and 1
 - DTB_ASNx, 5–28
- DTB alternate processor mode register
 - DTB_ALTMODE, 5–26
- DTB invalidate-all (ASM=0) process register
 - DTB_IAP, 5–27
- DTB invalidate-all process register DTB_IA,
 - 5–27
- DTB invalidate-single registers 0 and 1
 - DTB_ISx, 5–27
- DTB PTE array write registers 0 and 1
 - DTB_PTEx, 5–26
- DTB tag array write registers 0 and 1
 - DTB_TAGx, 5–25
- internal processor registers, 5–2
- load queue, 2–13
- Mbox control register M_CTL, 5–29
- memory management status register
 - MM_STAT, 5–28
- miss address file, 2–13
- order traps, 2–31
- pipeline abort delay with order trap, 2–16
- pipeline abort delays, 2–16
- store queue, 2–13

MBOX_BC_PRB_STALL Cbox CSR, defined, 5–35

MCHK interrupt, 6–14

Mechanical specifications, 3–17

Memory

- error case summary for, 8–11
- filling Dcache errors, 8–8
- filling Icache errors, 8–7

Memory address space

- load instructions with, 2–27
- merging rules, 2–30
- store instructions with, 2–28

Memory barrier instructions

- translation to external interface, 4–5

Memory barriers, 2–32

Memory reference unit. See Mbox

MF_FPCR instruction, 6–12

Microarchitecture

- summarized, 2–1

MiscVref signal pin, 3–5

Miss address file, 2–13

- I/O address space loads, 2–27
- memory address space loads, 2–27
- memory address space stores, 2–28

MM_STAT memory management status register, 5–28

- at power-on reset state, 7–16

MT_FPCR instruction, 6–12

MT_FPCR synchronous trap, 6–14

N

NoConnect pin type, 3–3

Nonexistent memory

- processing, 4–38

NOP, 21264/EV68A command, 4–21

Note convention, xxi

Numbering convention, xxi

NXM. See Nonexistent memory

NZNOP, 21264/EV68A command, 4–21

O

O_OD pin type, 3–3, 9–2

- values for, 9–4

O_OD_TP pin type, 3–3, 9–2

- values for, 9–4

O_PP pin type, 3–3, 9–2

- values for, 9–5

O_PP_CLK pin type, 3–3, 9–2

- values for, 9–5

OPCDEC fault, 6–13

Opcodes

- IEEE floating-point, A–9
- independent floating-point, A–11
- reserved for Compaq, A–8
- reserved for PALcode, A–9
- summary of, A–12
- VAX floating-point, A–11

Open-drain driver for test pins. See O_OD_TP

Open-drain output driver. See O_OD pin type

Operating temperature, 10–1

P

Packaging, 3–18

Paired instruction fetch order, 6–9

PAL_BASE register, 5–15

- after fault reset, 7–8
- after warm reset, 7–11
- at power-on reset state, 7–15
- through sleep mode, 7–10

- PALcode
 - conditional branches in, D-14
 - described, 6-1
 - entries points for, 6-12
 - exception entry points, 6-13
 - guidelines for, D-1
 - HW_LD instruction, 6-3
 - HW_MFPR instruction, 6-6
 - HW_MTPR instruction, 6-6
 - HW_RET instruction, 6-5
 - HW_ST instruction, 6-4
 - required function codes, 6-3
 - reserved opcodes for, 6-3
 - restrictions for, D-1
- PALmode environment, 6-2
- PALshadow registers, 6-11
- PCTR_CTL performance counter control counter register
 - updating, D-17
- PCTR_CTL performance counter control register, 5-23
 - at power-on reset state, 7-15
 - updating, D-18
- PCTX Ibox process context register, 5-21
 - after fault reset, 7-8
 - after warm reset, 7-11
 - at power-on reset state, 7-15
 - through sleep mode, 7-10
- Phase-lock loop. See PLL
- Physical address considerations, 4-4
- Pipeline
 - abort delay, 2-16
 - Dcache access, 2-16
 - Ebox execution, 2-16
 - Ebox slotting, 2-18
 - Fbox execution, 2-16
 - instruction fetch, 2-14
 - instruction group definitions, 2-17
 - instruction issue rules, 2-16
 - instruction latencies, 2-20
 - instruction retire rules, 2-21
 - instruction slot, 2-14
 - issue queue, 2-15
 - organization, 2-13
 - register maps, 2-15
 - register reads, 2-16
- PLL
 - description, 7-19
 - output clocks, 7-19
 - ramp up, 7-6
- PLL_IDD, values for, 9-3
- PLL_VDD signal pin, 3-5
- PLL_VDD, values for, 9-3
- PllBypass_H signal pin, 3-5
- PMPC ProfileMe register, 5-8

- Ports
 - IEEE 1149.1, 11-3
 - serial terminal, 11-2
 - SROM load, 11-2
- Power
 - maximum, 9-1
 - sleep defined, 9-3
- Power supply sequencing, 9-5
- Power-on
 - flow signals and constraints, 7-7
 - reset flow, 7-1
 - self-test and initialization, 11-5
 - timing sequence, 7-3
- PRB_TAG_ONLY Cbox CSR, 4-28
 - defined, 5-34
- Privileged architecture library code
 - See PALcode
- Probe commands, system, 4-26, 4-40
- Probe queue, 2-11
- PROBE_BC_ERR error status in C_STAT, 5-42
- ProbeResponse, 21264/EV68A command, 4-21, 4-24, 4-39
- ProfileMe mode, 6-20
- Push-pull output clock driver. See O_PP_CLK
- Push-pull output driver. See O_PP

R

- R31
 - load instructions with, 2-23
 - retire instructions with, 2-22
 - speculative loads to, 2-25
- RAMP1 reset machine state, 7-17
- RAMP2 reset machine state, 7-18
- Ranges and extents convention, xxi
- RdBlk, 21264/EV68A command, 4-39
- RdBlkI, 21264/EV68A command, 4-39
- RdBlkMod, 21264/EV68A command, 4-39
- RdBlkModSpec, 21264/EV68A command, 4-39
- RdBlkModVic, 21264/EV68A command, 4-39
- RdBlkSpec, 21264/EV68A command, 4-39
- RdBlkSpecI, 21264/EV68A command, 4-39
- RdBlkVic, 21264/EV68A command, 4-39
- RdBlkVicI, 21264/EV68A command, 4-39
- RdBytes, 21264/EV68A command, 4-39
- RdLWs, 21264/EV68A command, 4-39
- RdQWs, 21264/EV68A command, 4-39
- RDVIC_ACK_INHIBIT Cbox CSR, 4-25, 4-26
 - defined, 5-34

- ReadBlk, 21264/EV68A command, 4–21
 - system probes, with, 4–41
- ReadBlkI, 21264/EV68A command, 4–22
- ReadBlkMod, 21264/EV68A command, 4–22
 - system probes, with, 4–41
- ReadBlkModSpec, 21264/EV68A command, 4–22
- ReadBlkModVic, 21264/EV68A command, 4–22
- ReadBlkSpec, 21264/EV68A command, 4–22
- ReadBlkSpecI, 21264/EV68A command, 4–22
- ReadBlkVic, 21264/EV68A command, 4–22
- ReadBlkVicI, 21264/EV68A command, 4–22
- ReadBytes, 21264/EV68A command, 4–22
- ReadData, SysDc command, 4–10, 4–11, 4–12
- ReadDataDirty, SysDc command, 4–10, 4–11, 4–12
- ReadDataError, SysDc command, 4–10, 4–11, 4–12, 4–13
- ReadDataShared, SysDc command, 4–10, 4–11, 4–12
- ReadDataShared/Dirty, SysDc command, 4–10, 4–11, 4–12
- ReadLWs, 21264/EV68A command, 4–22
- ReadQWs, 21264/EV68A command, 4–22
- Register access abbreviations, xix
- Register figure conventions, xxi
- Register maps, pipelined, 2–15
- Register rename maps, 2–6
- Replay traps, 2–31
- RESET interrupt, 6–14
- Reset state machine
 - major operations of, 7–1
- Reset_L signal pin, 3–5
 - power-on reset flow, 7–1
- RET misprediction, in PALcode, D–15
- Retire logic, 2–8, D–1
- RO,n convention, xix
- RUN reset machine state, 7–18
- RW,n convention, xx

S

- SAMPLE public instruction, B–1
- Scrubbing single-bit errors, D–19
- I_CTL Ibox control register
 - updating I_CTL, D–18
- Second-level cache. See Bcache

- Security holes
 - with UNPREDICTABLE results, xxii
- Serial terminal port, 11–2
- SET_DIRTY_ENABLE Cbox CSR, 4–23, 5–39, 7–12
 - programming, 4–24
- SharedToDirty, 21264/EV68A command, 4–22, 4–40
 - system probes, with, 4–41
- Signal name convention, xxi
- Signal pin types, defined, 3–3
- Signal pins
 - test, 11–1
- Single-bit error scribbling, D–19
- Single-bit errors in hardware, correcting, 8–2
- SIRR software interrupt request register, 5–10
 - at power-on reset state, 7–15
- Sleep mode
 - flow, 7–9
 - timing sequence, 7–11
- SLEEP mode register, 5–21
 - at power-on reset state, 7–15
- Spare pin type, 3–3
- SPEC_READ_ENABLE Cbox CSR, 4–23
 - defined, 5–35
- SQ. See Store queue
- SROM content map, 11–6
- SROM initialization, 11–5
- SROM interface, in microarchitecture, 2–13
- SROM line, Icache bit fields in a, 11–6
- SROM load, 7–6
- SROM load operation, 11–2
- SromClk_H signal pin, 3–5, 11–2
- SromData_H signal pin, 3–5, 11–2
- SromOE_L signal pin, 3–5, 11–2
- SSRAMs
 - dual-data rate pin assignments, E–3
 - late-write non-bursting pin assignments, E–2
- STC_ENABLE Cbox CSR, 4–24
- STCChangeToDirty, 21264/EV68A command, 4–13, 4–22, 4–40
- Storage temperature, 9–1

Store instructions
 Dcache ECC errors with, 8–4
 I/O address space, 2–29
 I/O reference ordering, 2–31
 Mbox order traps, 2–31
 memory address space, 2–28
 memory reference ordering, 2–30
 translation to external interface, 4–5

Store queue, 2–13

Store-load order trap, 2–31

STx_C instructions
 in-order processing for, 4–15
 locking mechanism for, 4–14

SUM bit. See Summary bit

Summary bit, in FPCR, 2–36

Supply voltage signal pins. See I_DC_POWER pin type

Synchronous static random-access memory. See SSRAMs

SYS_BPHASE_LD_VECTOR Cbox CSR, 4–18
 defined, 5–38

SYS_BUS_FORMAT Cbox CSR, defined, 5–34

SYS_BUS_SIZE Cbox CSR, 4–21
 defined, 5–34

SYS_CLK_DELAY Cbox CSR, defined, 5–36

SYS_CLK_LD_VECTOR Cbox CSR, 4–18
 defined, 5–38

SYS_CLK_RATIO Cbox CSR, defined, 5–34

SYS_CLKFWD_ENABLE Cbox CSR, defined, 5–36

SYS_CPU_CLK_DELAY Cbox CSR
 defined, 5–38

SYS_DDM_FALL_EN Cbox CSR, 4–18
 defined, 5–36

SYS_DDM_RD_FALL_EN Cbox CSR, 4–18

SYS_DDM_RD_RISE_EN Cbox CSR, 4–19

SYS_DDM_RISE_EN Cbox CSR, 4–18
 defined, 5–36

SYS_DDMF_ENABLE Cbox CSR, 4–19
 defined, 5–36

SYS_DDMR_ENABLE Cbox CSR, 4–19
 defined, 5–36

SYS_FDBK_EN Cbox CSR, 4–18
 defined, 5–38

SYS_FRAME_LD_VECTOR Cbox CSR, 4–19,
 4–31
 defined, 5–38

SYS_RCV_MUX_CNT_PRESET Cbox CSR, 4–31
 defined, 5–36

SYS_RCV_MUX_PRESET Cbox CSR, 4–33

SysAddIn_L signal pins, 3–5

SysAddInClk_L signal pin, 3–5

SysAddOut_L signal pins, 3–5

SysAddOutClk_L signal pin, 3–5

SYSBUS_ACK_LIMIT Cbox CSR, 4–25
 defined, 5–34

SYSBUS_FORMAT Cbox CSR, 4–21

SYSBUS_MB_ENABLE Cbox CSR, 4–23
 defined, 5–34
 operation, 2–32

SYSBUS_VIC_LIMIT Cbox CSR, 4–26
 defined, 5–34

SysCheck_L signal pin, 3–5

SYSCLK, 4–31

SysData_L signal pin, 3–5

SysDataInClk_H signal pin, 3–5

SysDataInValid_L signal pin, 3–5
 rules for, 4–34

SysDataOutClk_L signal pin, 3–5

SysDataOutValid_L signal pin, 3–5
 rules for, 4–35

SysDc commands, 4–11
 system probes, with, 4–42

SysDc field, system to 21264/EV68A commands,
 4–29

SYSDC_DELAY Cbox CSR, 4–32
 defined, 5–38

SysFillValid_L signal pin, 3–5
 rules for, 4–35

System clock ratio configuration, 7–4

System initialization, 7–7

System interface clocks, programming, 4–18

System port, 4–16

SysVref signal pin, 3–6

T

Tag parity errors, 8–2

TB fill flow, 2–34, 6–14

Tck_H signal pin, 3–6

Tdi_H signal pin, 3–6

Tdo_H signal pin, 3–6

Temperatures
 maximum average per frequency, 10–2
 operating, 10–1

Terminology, xix

TestStat_H signal pin, 3–6
 purpose for, 11–4
 with BiST and SROM load, 7–6

Thermal design characteristics, 10–6

Tms_H signal pin, 3–6

Traps

load-load order, 2–31

Mbox order, 2–31

replay, 2–31

store-load order, 2–31

Trst_L signal pin, 3–6

U

UNALIGN fault, 6–13

Unaligned convention, xx

UNDEFINED, xxii

UNPREDICTABLE, xxii

V

VA virtual address register, 5–4

at power-on reset state, 7–15

VA_CTL virtual address control register, 5–4

at power-on reset state, 7–15

updating VA_48 field, D–18

VA_FORM virtual address format register, 5–5

at power-on reset state, 7–15

VAF. See Victim address file

VAX floating-point instruction opcodes, A–11

VBIAS defined, 9–2

VDB. See Victim data buffer

VDBFlushRequest, 21264/EV68A command, 4–21

VDD signal pin list, 3–16

VDD, values for, 9–3

VDF. See Victim data file

Vdiff defined, 9–2

Victim address file

described, 2–11

Victim address file, described, 2–11

Victim data buffer (VDB), 4–8

Virtual address support, 1–2

Virtual program counter logic, 2–2

VPC. See Virtual program counter logic

VREF, values for, 9–3

VSS signal pin list, 3–16

W

WAIT_BiSI reset machine state, 7–18

WAIT_BiST reset machine state, 7–18

WAIT_ClkFwdRst0 reset machine state, 7–18

WAIT_ClkFwdRst1 reset machine state, 7–18

WAIT_INTERRUPT reset machine state, 7–19

WAIT_NOMINAL reset machine state, 7–17

WAIT_RESET reset machine state, 7–18

WAIT_SETTLE reset machine state, 7–17

WAKEUP interrupt, 6–14

WAR, eliminating, 2–6

Warm reset flow, 7–11

WAW

eliminating, 2–6

WMB instruction processing, 2–33

WO,n convention, xx

Wrap order

double-pumped, 4–38

interleaved, 4–37

WrBytes, 21264/EV68A command, 4–22, 4–39

Write hint instructions, translation to external interface, 4–5

WRITE_MANY chain, 5–38

example, 5–39

values for Bcache initialization, 7–12

WRITE_MANY register

after fault reset, 7–8

after warm reset, 7–11

through sleep mode, 7–10

WRITE_ONCE chain description, 5–33

Write-after-read. See WAR

Write-after-write. See WAW

WrLWs, 21264/EV68A command, 4–22, 4–39

WrQWs, 21264/EV68A command, 4–22, 4–39

WrVictimBlk, 21264/EV68A command, 4–22, 4–39

system probes, with, 4–41

X

X convention, xxi

Free Manuals Download Website

<http://myh66.com>

<http://usermanuals.us>

<http://www.somanuals.com>

<http://www.4manuals.cc>

<http://www.manual-lib.com>

<http://www.404manual.com>

<http://www.luxmanual.com>

<http://aubethermostatmanual.com>

Golf course search by state

<http://golfingnear.com>

Email search by domain

<http://emailbydomain.com>

Auto manuals search

<http://auto.somanuals.com>

TV manuals search

<http://tv.somanuals.com>