



This manual is for reference and historical purposes, all rights reserved.

This page is copyright© by M. Butkus, NJ.

This page may not be sold or distributed without the expressed permission of the producer
I have no connection with any camera company

On-line camera manual library

This is the full text and images from the manual. This may take 3 full minutes for the PDF file to download.

If you find this manual useful, how about a donation of \$3 to: M. Butkus, 29 Lake Ave., High Bridge, NJ 08829-1701 and send your e-mail address so I can thank you. Most other places would charge you \$7.50 for a electronic copy or \$18.00 for a hard to read Xerox copy.

This will allow me to continue to buy new manuals and pay their shipping costs.

It'll make you feel better, won't it?

**If you use Pay Pal or wish to use your credit card,
click on the secure site on my main page.**

Download from Www.Somanuals.com. All Manuals Search And Download.

CONTAX T2

Instruction manual

Bedienungsanleitung

Mode d'emploi

Manual de instrucciones

Download from [Www.Somanuals.com](http://www.Somanuals.com). All Manuals Search And Download.

Thank you for your purchase of the CONTAX T2. This camera carries on the basic CONTAX philosophy of a "camera to produce works of art" while featuring an electronically controlled focusing system and an exposure control function with program AE in addition to aperture priority AE. The result is an exceptionally easy-to-use 35 mm lens shutter-type camera. Before using this camera, be sure to read the Instruction Manual carefully and be familiar with proper use.

Vielen Dank, daß Sie sich für den Kauf eines CONTAX-Produktes entschieden haben. Mit der CONTAX T2 besitzen Sie nun eine Kompaktkamera, die von Verarbeitung und technischer Ausstattung her einen Spitzenplatz einnimmt und auch höchsten Ansprüchen genügt. Um mit allen Eigenschaften dieser Camera vertraut zu werden, sollten Sie vor der ersten Inbetriebnahme unbedingt die Bedienungsanleitung sorgfältig studieren.

Contents

Names of Parts and Functions	8	Bulb Exposure.....	70
Display in the Viewfinder.....	12	Data-Back (sold separately).....	72
LCD Counter	17	Camera Strap/Camera Case	83
Basic Picture-Taking Procedures	19	Camera Care.....	85
Insert the Battery	20	Camera Storage	85
Check the Battery	22	Main specifications.....	90
Load the Film	26		
Turn the Main Switch ON (AF).....	30		
Set the Aperture	33		
Take the Picture.....	36		
Rewind the Film	40		
Shooting Techniques	43		
Focus Lock.....	44		
Manual Focus	48		
AE Lock	52		
Exposure Compensation	56		
Self-timer Shooting	62		
Flash Photography	66		

Names of Parts and Functions

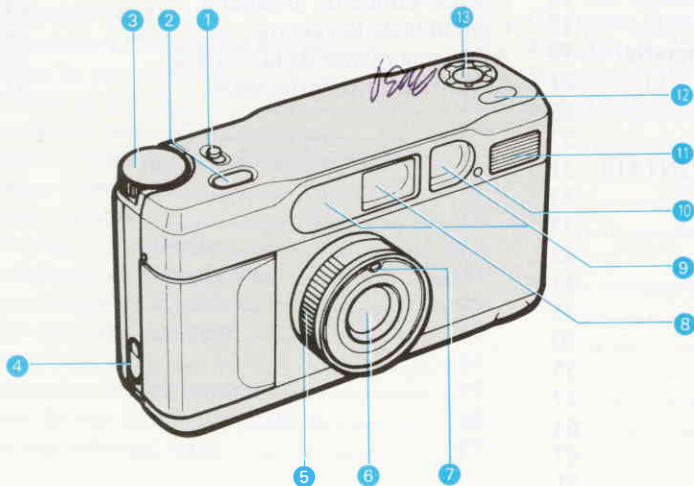

- 1 Self-timer Switch
- 2 Shutter Release
- 3 Main Switch/Focus Dial
Operate at follows:
(1) Power ON/OFF Switch
OFF: "⊖" mark
ON: "AF", "∞~0.7" mark
(2) Focus Mode Switch
Auto Focus: "AF" mark
Manual Focus "∞~0.7" mark
- 4 Camera Back Release Knob
- 5 Aperture Ring
Used for setting the aperture and changing to the flash photography mode.
- 6 Taking Lens
- 7 Light Sensor
- 8 Viewfinder
- 9 Focusing window
- 10 Self-timer LED
Blinks when the self-timer is operating.
- 11 Flash
- 12 LCD Counter
- 13 Exposure Compensation Dial
Possible to set the correction width up to $\pm 2EV$ in units of 0.5EV

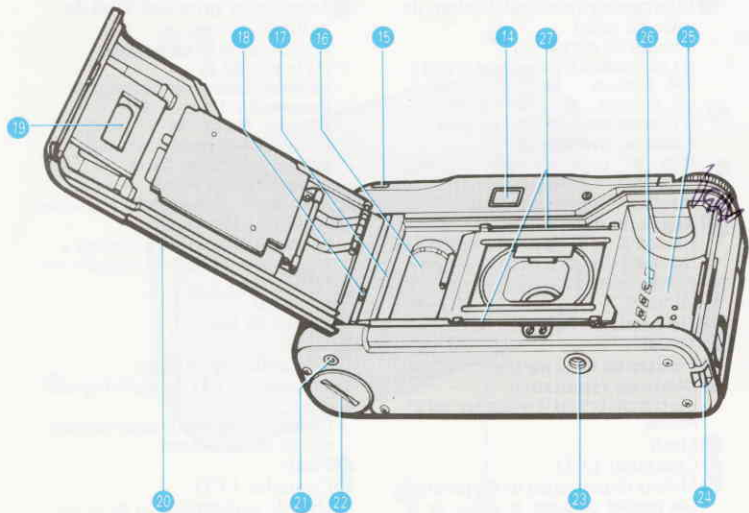

- 14 Viewfinder Eyepiece
- 15 Exposure Compensation Display Window
- 16 Take-up Spool
- 17 Film Tip Mark
- 18 Camera Back Release Pin
- 19 Film Check Window
Possible to check whether film is loaded or not.
- 20 Camera Back
- 21 Manual Rewind Button
Press this button when you wish to rewind the film midway through the roll.
- 22 Battery Compartment Cover
- 23 Tripod Socket
- 24 Strap Lug
- 25 Film Chamber
- 26 DX Contact
- 27 Film Guide

Display in the Viewfinder

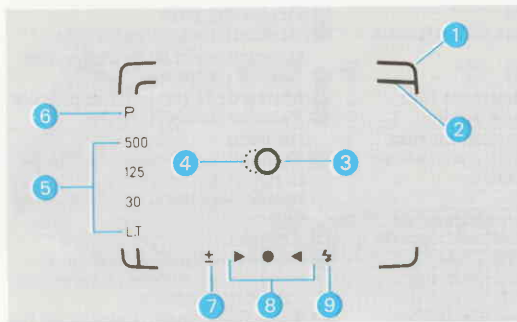

The picture frame and focusing frame (1 ~ 4) are displayed constantly. Other displays appear when the camera is operated as follows, appearing for 8 seconds and then automatically disappearing to save battery power:

1. When the main switch is turned ON.
2. When the shutter button or focus dial are operated while the main switch is ON.

1 Picture Frame

When the subject you want to shoot is located far away, the area within this frame will appear in the photograph.

2 Close-range Picture Frame

When the subject you want to shoot is at a distance between 0.7 m and 1 m, the area within this frame will appear in the photograph.

3 Focus Frame

The Frame for focusing on the subject.

4 Close-range Focus Frame

Focusing Frame for close-range photography (0.7 m ~ 1 m).

5 Shutter Speed

Of the shutter speed displays, “500” indicates 1/500 sec and “30” indicates 1/30 sec. When two displays appear, it indicates a value between those two. When LT is lit, it indicates a shutter speed that is between slightly less than 1/30 sec and 1 sec. When the light is darker, the LT display

will blink and the camera will go to bulb exposure.

When “500” blinks, it indicates over-exposure.

6 Program Mark

When the aperture is set to F2.8 and automatically closes, “P” will light and the program AE will be set.



7 Exposure Compensation Mark

When the exposure compensation dial is set to a value other than “0”, the “±” display will light.

8 Focus Mark

Indicates the focusing conditions.

9 Flash Mark

Displayed when the aperture ring is set to “” or to “”.

 is blinking: Charging

 is lit: Charging completed

LCD Counter/LCD Bildzählwerk/Compteur LCD/Contador LCD

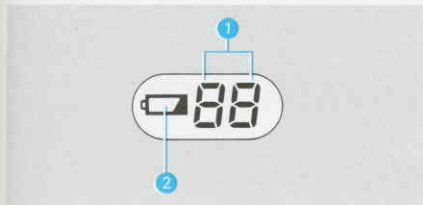

- 1 Exposure Counter (displays time remaining on self-timer, and time elapsed during bulb exposure).
- 2 Battery Warning Mark

- 1 Bildzählwerk, dient gleichzeitig zur Anzeige des Sekundenablaufes bei Selbstauslöser- und Langzeitbelichtungen.
- 2 Batterie-Warnsignal

- 1 Compteur de poses (il affiche le temps restant sur le retardateur et le temps écoulé pendant une prise de vue en pose B.)
- 2 Symbole de pile faible

- 1 Contador de exposiciones indica el tiempo restante del autodisparador y el tiempo transcurrido durante la exposición larga.
- 2 Marca de aviso de la pila

Basic Picture-Taking Procedures
Grundbegriffe der Handhabung
Préparatifs pour la prise de vue
Procedimientos básicos para fotografiar

1. Insert the Battery.

1 Use a coin to open the battery compartment cover by rotating it in the direction of the arrow.

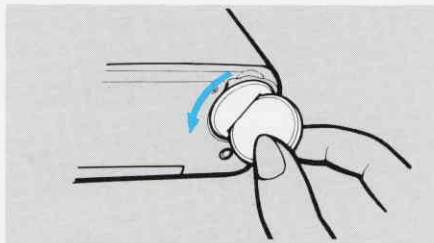

2 Insert the battery in the correct direction as shown by the mark in the battery compartment and then replace the battery compartment cover.

- The camera uses a 3V lithium battery (CR123A or DL123A).



Check the Battery.

If only the film counter is displayed and the “” (battery warning mark) is not displayed in the LCD counter, the battery voltage is normal.

<Battery Replacement>

If the “” mark is lit in the LCD counter, it is time to replace the battery. Turn the main switch OFF, open the battery compartment cover and replace the battery with a new one.

- Although it is still possible to photograph even when the “” mark is lit, be sure to replace the battery as soon as possible. If the battery capacity exceeds the usage limit, the LCD will go out and the camera will cease to function.

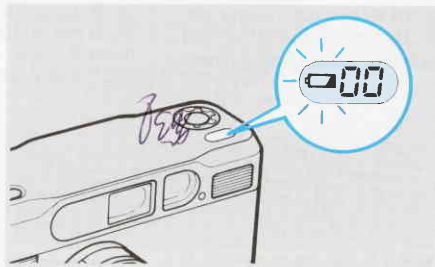

< Battery Precautions >

- Battery performance will be reduced temporarily in low temperatures (under 0°C). If you are shooting in cold weather, keep the camera warm inside your jacket and take them out only when they are needed. The battery performance reduced by cold temperature will return to normal in normal conditions.
- If battery poles are soiled with sweat or grease, poor contact may result. Wipe both poles clean before loading the batteries.
- If you are going on a long trip, bring spare batteries with you.
- Do not throw used batteries into fire and do not charge, short, disassemble or heat them because it is dangerous.
- The camera will not function if the battery is not properly inserted.
- A 3V lithium battery (CR123A or DL123A) cannot be recharged.

< Batteriehinweise >

- Die Batterieleistung nimmt bei Minustemperaturen ab. Halten Sie die Camera weitgehendst unter der Oberbekleidung warm. Die Batterieleistung steigt bei normaler Umgebungstemperatur wieder auf den üblichen Wert an.
- Verschmutzte Batteriekontakte können zu Funktionsstörungen führen. Kontakte vor dem Einsetzen mit einem trockenen Tuch säubern.
- Auf längeren Reisen stets eine Reservebatterie mitführen.
- Verbrauchte Batterien nicht erhitzen oder in offenes Feuer werfen (Explosionsgefahr).
- Mit falsch gepolter Batterie ist die Camera nicht funktionsfähig.
- Die 3 Volt Lithiumbatterie ist nicht wiederaufladbar.

2. Open the camera back and load film with the DX mark.

1 Push the camera back release knob in the direction shown by the arrow to open the camera back.

2 Load film with the DX mark and align the tip of the film with the “” mark.

Load the film in the film chamber at a slant from above. Next pull the film tip to the orange-colored “” mark position and place it on the take-up spool.

Be careful at this time that the film does not rise up from the film guide.

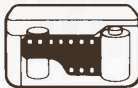
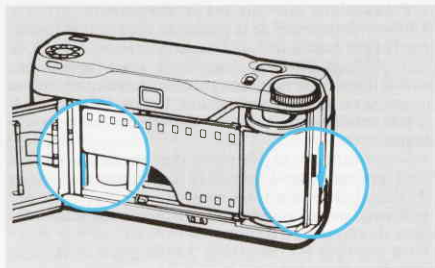

- The sensitivity of film marked with the DX mark is automatically set. Film without the DX mark should be set to ISO100.
- Be careful not to touch or soil the DX contact.
- Avoid direct sunlight when replacing film.

3 Securely close the camera back.
When the camera back is closed, the film will be advanced automatically while the film counter advances to “01” and stops.

- If the film counter is blinking “00”, the film has not been correctly advanced. Open the camera back and reload the film.

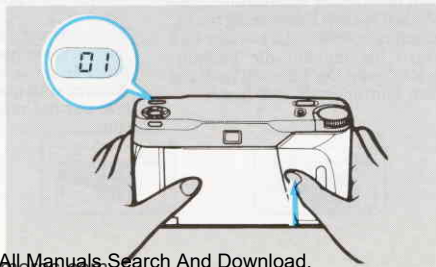

3. Turn the main switch/focus dial ON (AF).

When the main switch/focus dial is turned to “☉” → “AF” the camera power will go ON and the camera will be set to the auto-focus mode. The lens cover will open automatically and the lens will emerge so that photography is possible.

- If you are not using the camera right away, turn the main switch/focus dial to “☉” (OFF) to avoid inadvertently tripping the shutter.
- When the main switch/focus dial is turned to “☉”, the lens is housed and the cover closes.

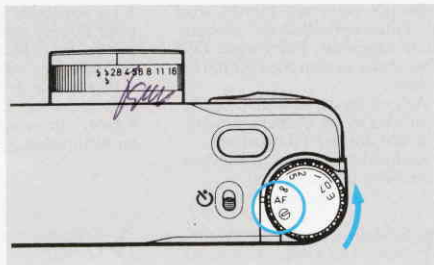

4. Set the aperture.

Turn the aperture ring on the lens to set the aperture. At this time, the shutter speed will be displayed in the viewfinder according to the aperture.

For exposure control on the CONTAX T2, there is the aperture priority AE method in which the appropriate shutter speed is automatically controlled by setting an arbitrary aperture as well as the aperture priority program AE method in which there is an additional program function when set to F2.8.

<Exposure control range chart>

As is shown in the chart, the light meter range and maximum shutter speed change in accordance with the aperture for program or for aperture priority.

- The "P" mark will turn on when in program AE.

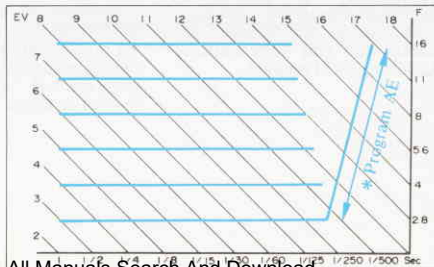
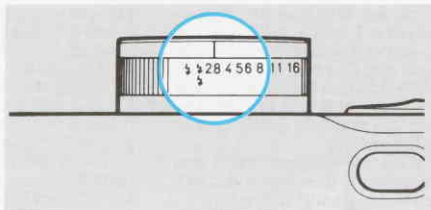

- When the "500" The shutter speed is blinking in the viewfinder, it indicates overexposure. Set the aperture so that it does not blink at "500" or set to F2.8 and set to the program mode and photograph. If the "500" continues to blink, the light conditions have exceeded the exposure control range and you must use film of a lower sensitivity.
- When "LT" is lit or is blinking, either use a tripod to prevent blurring of the picture from an unsteady hold on the camera or carry out flash photography.
- When "LT" is blinking, the camera will automatically go to bulb exposure.

- Blinkt die Sucheranzeige "500" in Funktion Zeitautomatik, so erfolgt Überbelichtung. Verkleinern Sie die Blende, bis "125" aufleuchtet oder wählen Sie die Programmautomatik (Position 2,8). Blinkt die "500" auch dann noch, so ist die Helligkeit zu groß, es muß ein niedrigempfindlicher Film gewählt werden.
- Leuchtet oder blinkt die Sucheranzeige "LT" (Long Time), so muß wegen Verwacklungsgefahr ein Stativ oder eine feste Cameraunterlage verwendet oder eine Blitzfunktion gewählt werden.
- Blinkt "LT", so wird eine Belichtungszeit von über 1 Sek. benötigt, und die Camera schaltet automatisch auf B-Funktion, d.h. der Verschluss bleibt offen solange der Auslöser gedrückt wird.

5. Take the picture.

- 1 Point the focus frame at the subject you wish to focus on and press the shutter button down halfway.
- 2 Focusing will take place automatically and the “●” mark for focus display will light.
- 3 Press the shutter button down all the way. The shutter will trip and the picture will be taken.

Photographic range: 0.7 m ~ ∞

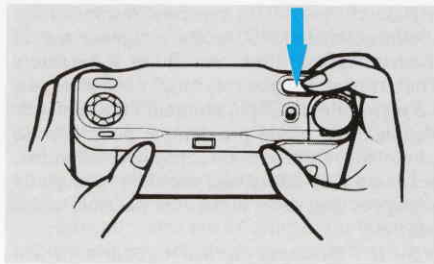

- When the “▶” mark is blinking, you are too close to the subject. Shoot at a distance greater than 0.7 m.
- Even though the “▶” mark is blinking the shutter will trip.
- When the distance of the subject is approximately 0.4 m or less, the “●” mark will light but the subject will not be focused.
- In order to adjust the focus for shooting, the lens barrel will move forward and backward when the shutter is depressed. Be careful not to touch the lens barrel when shooting.
- Blinkt das Signal “▶”, so befinden Sie sich zu nahe am Motiv (unter 0,7 m). Vergrößern Sie die Aufnahmeentfernung.
- Auch wenn das Signal “▶” blinkt, kann der Verschuß ausgelöst werden.
- Bei einer Motiventfernung von ca. 0,4 m oder weniger leuchtet zwar das Signal “●” auf, das Motiv wird jedoch nicht scharf abgebildet.
- Da sich das Objektiv beim Auslösen zwecks Fokussierung etwas vor- und rückwärts bewegt, achten Sie bitte darauf, diese Bewegung z.B. durch Ihre Finger nicht zu hemmen.

6. When you have used the entire roll of film, automatic rewinding of the film will begin.

During film rewind, the exposure counter will display the frame numbers in descending order. When rewind is completed, the motor will stop and the counter will blink at "00". After finishing film rewind, open the camera back and remove the film.

- Bring exposed film for development as soon as possible.
- If you wish to rewind the film midway through use, press the manual rewind button on the bottom of the camera. (Do not press with needles or other sharply pointed objects).

Shooting Techniques

Weitere Aufnahmehinweise

Techniques de prise de vue

Técnicas de fotografía

Focus Lock

Focus lock is used during auto-focus photography when, depending on the composition of the picture, the subject you want to focus on might go out of the focus frame.

1 Aim the focus frame at the subject you want to focus on and press the shutter release halfway down. Focusing will take place and the “●” mark will light (focus-lock).

2 With the shutter release held halfway down, return the camera to the composition you want to photograph and then depress the shutter release all the way to take the picture.



- The focus is locked as long as the shutter release is held halfway down and it is possible to change the direction of the camera without changing the shooting distance.

- Removing your finger from the shutter release cancels focus-lock.

- The following objects are difficult to focus on. Use focus-lock to first focus on another object at the same distance before shooting.

- ◆ When there is a strong light source such as sunlight in the focus frame or periphery.

- ◆ Insubstantial subjects such as sparklers and smoke.

- ◆ Shiny surfaces such as car bodies and water.

- ◆ Non-reflecting surfaces such as hair.

- ◆ Subjects on the other side of glass.

- ◆ Extremely small objects.

- Die Entfernungseinstellung bleibt gespeichert, solange der Auslöser leicht gedrückt bleibt.

- Wird der Auslöser freigegeben, wird die Speicherung gelöscht.

- Folgende Objekte sind nicht oder nur schwierig zu fokussieren. Wählen Sie ein "Ersatzmotiv" in gleicher Entfernung und verwenden Sie den Schärfespeicher.

- ◆ Starke Lichtquellen in oder nahe der Fokuszzone.

- ◆ Körperlose Motive wie Rauch oder Feuerwerk.

- ◆ Stark reflektierende Motive wie Autolack oder Wasserflächen.

- ◆ Nicht reflektierende Objekte wie Haar.

- ◆ Motive hinter Glas.

- ◆ Extrem kleine Objekte.

Manual Focus

- 1 Set the main-switch/focus dial in the manual focus range.
- 2 Aim the focus frame toward the subject you want to focus on and turn the focus dial while observing the focus mark to focus on the object.
- 3 Press the shutter release to take the picture. Allows you to change the composition after focusing or set the distance by visual measurement so that you won't miss taking a picture at just the right moment.

<Shooting Distant Scenery >

When shooting distant scenery, set the focus dial to the “∞” mark and shoot to obtain sharper photographs.

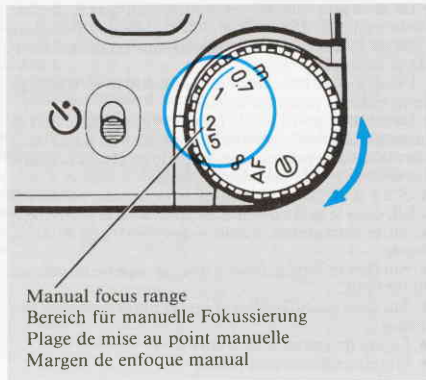

<Focus Mark>

“◀” **mark (red)** The camera is focused on an area in front of the subject in the focus frame. (Front Mis-focus)

“●” **mark (green)** The camera is focused on the subject in the focus frame. (Sharp Focus)

“▶” **mark (red)** The camera is focused on an area further removed than the subject in the focus frame. (Rear Mis-Focus)

<Fokus-Signal>

“◀” **Symbol (rot)** Die Entfernungseinstellung erfolgt auf einen Punkt vor dem Motiv. (Fokussierung zu kurz)

“●” **Signal (grün)** Die Fokussierung erfolgt exakt auf das Motiv in der Fokuszone. (Exakte Fokussierung)

“▶” **Symbol (rot)** Die Entfernungseinstellung erfolgt auf einen Punkt hinter dem Motiv. (Fokussierung zu weit)

<Symbole de mise au point>

Symbole “◀” (rouge) L'appareil fait la mise au point sur une zone devant le sujet dans le cadre de mise au point (mise au point incorrecte vers l'avant)

Symbole “●” (vert) L'appareil fait la mise au point sur le sujet dans le cadre de mise au point (sujet net).

Symbole “▶” (rouge) L'appareil fait la mise au point sur une zone située au-delà du sujet dans le cadre de mise au point (mise au point incorrecte vers l'arrière).

<Marca de enfoque>

Marca “◀” (roja) La cámara está enfocando el área situada frente al motivo en el cuadro de enfoque. (Desenfoque frontal)

Marca “●” (verde) La cámara está enfocando el motivo en el cuadro de enfoque. (Enfoque nítido)

Marca “▶” (roja) La cámara está enfocando el área situada más allá del motivo en el cuadro de enfoque. (Desenfoque posterior)

The camera is so designed that when the shutter release is pressed halfway down the exposure at that time is locked (AE lock).

Particularly when you want to set the exposure for subjects removed from the center of the screen, point the camera toward the object you want to set the exposure to and change the back composition while keeping the shutter release pressed halfway down. When you trip the shutter, the exposure will agree with the subject for which AE lock was set.

Exposure and focus are locked simultaneously. When you want to choose separate subjects for exposure and focus settings, carry out manual focus and align the exposure by carrying out AE lock with the shutter release pressed halfway down. Then trip the shutter.

If you keep your finger on the shutter release after tripping the shutter, returning the shutter release to a half depressed state and then pressing again, you can continue to shoot with the exposure and focus locked. When you want to measure a new exposure, release your finger from the shutter release before depressing it again.

Exposure Compensation

Carry out exposure compensation if there is an extreme brightness contrast between the main subject and the background so that it will be impossible to obtain the right exposure for the main subject or when you deliberately want to under- or overexpose the subject.

The exposure compensation dial is normally set to “0”. When you want to correct the exposure, turn the exposure compensation dial to the desired value and set this in the exposure compensation display window. It is possible to set in units of 0.5 EV within a range of +2 EV and -2 EV. When the exposure compensation dial is set to a value other than “0”, the “±” will light.

- Be sure to return the exposure compensation dial to “0” after shooting.

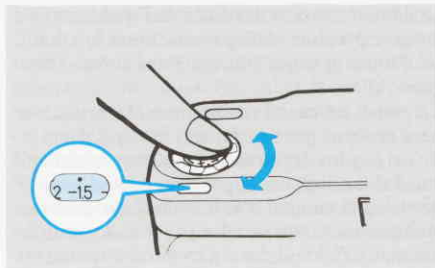

In cases of back light, the exposure is corrected within a range of +0.5 to +2.

When shooting human subjects with strong back light or with a bright sky or ocean in the background as well as subjects standing in front of windows where the back light is strong, the human subjects will be underexposed and appear too dark. In such cases, correct the exposure in a range of +0.5 to +2 to provide sufficient exposure.



When shooting subjects on a stage, correct the exposure in a range of -0.5 to -2 .

When shooting human subjects lighted by a spotlight where a dark background takes up a large ratio of the picture, the human subjects will be overexposed and appear excessively white. At such times, correct the exposure in a range of -0.5 to -2 to decrease the exposure.

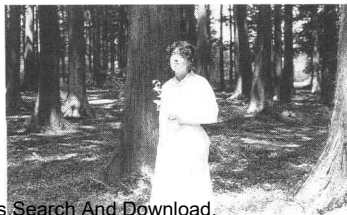

Self-timer Shooting

Use the self-timer when you want to include yourself in the picture.

- 1 Secure the camera with a tripod.
- 2 Turn the self-timer switch ON (red).
- 3 Focus the camera and depress the shutter release. The self timer will start and the shutter will be tripped when ten seconds have elapsed.

During self-timer operation the exposure counter will display the seconds remaining until the shutter is tripped. The self timer LED and the “●” mark in the viewfinder will blink.

- The exposure and focus are locked when the self-timer starts.
- If the shutter release is pressed during operation of the self-timer, the counter will return to the beginning and count down the remaining time.

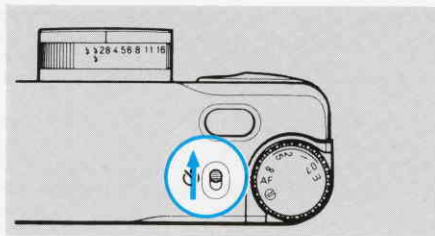

- To stop the self-timer either turn the self-timer switch OFF (black) or turn the main switch OFF.
- The exposure and focus are locked when the self-timer starts.
- If the shutter release is pressed during operation of the self-timer, the counter will return to the beginning and count down the remaining time.
- To stop the self-timer either turn the self-timer switch OFF (black) or turn the main switch OFF.
- It is not possible to start the self timer during flash charging.
- Be sure that the self-timer switch is set to OFF (black) when not using the self-timer.
- Entfernungseinstellung und Belichtungsmeßwert sind während der Selbstauslöser-vorlaufzeit gespeichert.
- Wird während der Vorlaufzeit der Auslöser gedrückt, so beginnt der Vorlauf erneut wieder bei "10".
- Soll die Selbstauslöserfunktion unterbrochen werden, so schalten Sie diese ab (schwarz sichtbar).
- Während des Aufladens des Blitzes kann der Selbstauslöser nicht ausgelöst werden.
- Wird der Selbstauslöser nicht benutzt, sollte sich der Schalter in der "OFF"—Position befinden.

Flash Photography

When the aperture ring is set to “ $\frac{1}{2}$ ” or to “ $\frac{1}{4}$ ”, the camera system goes to flash photography regardless of the brightness of the subject. The “ $\frac{1}{2}$ ” mark in the viewfinder blinks during charging and then remains lit when charging is finished. Confirm that charging is finished and then take the picture.

- Exposure control is done with the flashmatic method in which the aperture changes according to the distance from the subject.
- It is not possible to trip the shutter during charging.

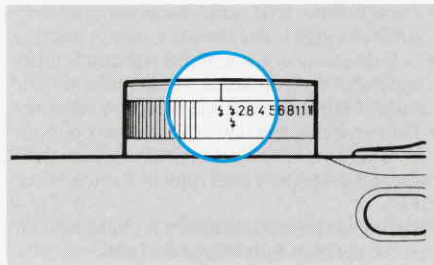

Film Sensitivity ISO-Bereich Sensibilité du film Sensibilidad de la película	Photographic distance Blitzbereich Portée du flash Distancia de fotografía
ISO 100	0.7m ~ 3m
ISO 400	1m ~ 6m

1 Flash Photography Mode: “” mark
This will allow you to photograph the subject and background with the correct lighting even when shooting in a dark setting or when shooting human subjects in front of a window where the background is too bright and produces back light.

2 Pre-flash mode: “” mark
When shooting human subjects in a dark setting, the pupils of human subjects' eyes will occasionally appear red in what is known as the “red-eye phenomenon”. The pre-flash mode is used to lessen this phenomenon. In this mode, there are two flash emissions. The shutter is tripped on the second flash emission. Be careful not to move the camera and make sure that the subjects do not move after the first flash emission.

1 Blitzfunktion “”
Diese Funktion kann bei Dunkelheit ebenso wie bei Tageslicht zwecks Schattenaufhellung verwendet werden.

2 Blitzfunktion “”
Bei Aufnahmen von Personen, die in das Objektiv blicken, sollte diese Funktion gewählt werden. Dabei wird vor der eigentlichen Blitzbelichtung ein Vorblitz gezündet, der Pupillen zur Verkleinerung zwingt und so den gefürchteten “Rotaugen”-Effekt reduziert. Achten Sie darauf, daß sich weder die Camera noch die aufzunehmende Person nach dem ersten (Vor-) Blitz bewegt.

Bulb Exposure

When exposure effects require an exposure of one second or more after pushing the shutter release halfway down, the camera automatically goes to the bulb exposure mode. At this time, the LT mark blinks in the viewfinder. The shutter will now remain open during the time you hold the shutter release down.

- The exposure counter will change to a timer display counting the time elapsed for bulb exposure. The display counts from “00” to “59” seconds and then repeats the count.
- Be sure to use a tripod to prevent blurring of the picture from an unsteady hold on the camera.

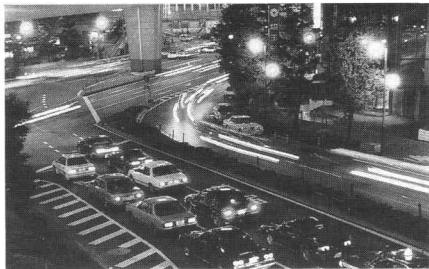

CONTAX T2 Data Back (separately sold)

This is a quartz-controlled LCD data-back featuring linked operation with the camera body simply by exchanging this unit with the camera back of the camera. The auto-dating function allows you to automatically include the date and time on your pictures.

Attaching to the Camera

- 1 Open the standard camera back and remove by pushing up the camera back release pin.
- 2 Insert the upper side of the attachment axle on the data-back to the attachment hole on the camera and then align the lower axle with the attachment hole while pushing up the camera back release pin. Then release your finger from the camera back release pin to complete attachment.

Display window/LCD-kontrollanzeige/Fenêtre d'affichage/
Ventanilla visualizadora

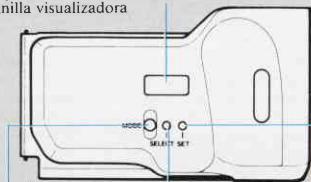

Date mode button

MODE-Taste

Touche de mode de datation

Botón de mode de fecha

Select button

SELECT-Taste

Touche de sélection

Botón selector

Set button

SET-Taste

Touche de réglage

Botón de ajuste

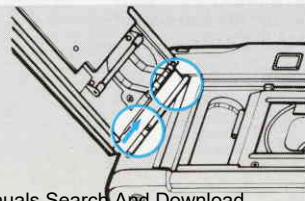

Including the Date and Time on the Picture

The date and time have been set beforehand in the factory, but they must be reset to the correct date and time in each country.

1 Choose the dating mode. Each time, date mode button is pressed the display will change from “year-month-day” to “day-hour-minute” to “- - - - -” (no date) to “month-day-year” to “day-month-year”. Use this to select the desired dating format.

2 Press the shutter release to photograph.

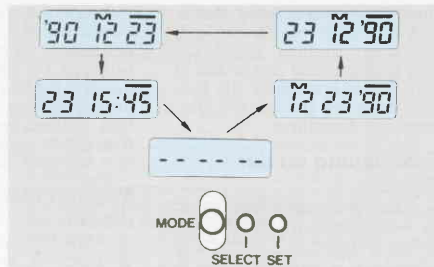

- The “—” mark in the upper right of the display window blinks to indicate that the display has been printed on the picture.
- The “M” display that appears above the numerals indicates “month” and is not printed on the picture.
- If you do not wish to print the date and time on the picture, go to the “- - - - -” mode and then photograph.
- The date will be printed on the lower right of the picture. When the background to the dating position is a bright color such as white or yellow, the numerals may be difficult to read.

- Blinkt die Markierung “—” in der oberen rechten Ecke der LCD-kontrollanzeige, so wurde die Datenbelichtung korrekt durchgeführt.
- Das “M” über der Datumsanzeige bedeutet “Monat”, dient nur als Hinweis und wird nicht einbelichtet.
- Soll keine Datierung erfolgen, so wählen Sie “- - - - -”.
- Achten Sie bei Aufnahmen mit Datierung darauf, daß sich in der rechten unteren Bildecke ein dunklerer Motivteil befindet. Vor hellem Hintergrund ist die Datierung schlecht lesbar.

© To correct the date and time data, do the following:

- 1** Press the mode button to show your desired dating mode.
- 2** Press the select button so that the numerals blink for the position to be corrected.
- 3** Press the set button to correct to the new value. In the time display, you can adjust the seconds while “:” is blinking. Adjust to the correct time and press the set button. The time will be properly set.
- 4** After making necessary corrections, press the select button until the numerals stop blinking.

© Die Korrektur von Datum und Uhrzeit wird wie folgt vorgenommen:

- 1** Drücken Sie die MODE-Taste und wählen Sie die gewünschte Datierungsform.
- 2** Drücken Sie die SELECT-Taste, bis die zu korrigierende Position blinkt.
- 3** Drücken Sie die SET-Taste, bis die gewünschte Zahl erscheint. Bei der Uhrzeit können die Sekunden während des Blinkens des “:” Symbols korrigiert werden. Ist die Zeit korrekt, auf die SET-Taste drücken.
- 4** Nach jeder Korrektur die SELECT-Taste drücken, bis das Blinken stoppt.

Replacing the Data-Back battery

The data-back battery is a long-life lithium battery (CR2025) and it should not be necessary to replace the battery for 3 ~ 4 years. If the battery is worn out, the date and time will be more difficult to read on the picture and the liquid crystal display will no longer display correctly. Replace the battery as shown in the figure.

- 1 Open the camera back, remove the screws securing the battery cover and open the cover.
 - 2 Insert a new battery in the battery compartment with the + side facing outside and then close the covers.
- After replacing the battery be sure to re-adjust the date and time.

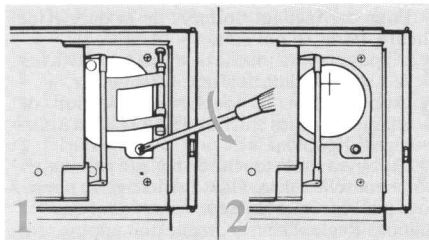

- Keep the data-back battery (CR2025) out of the reach of children. In case of accidental swallowing, consult a physician immediately.
- Die verbrauchte Batterie außer Reichweite von Kindern halten, nicht erhitzen oder in offenes Feuer werfen. Entsorgung über Ihren Händler.
- Tenez la pile du dos dateur (CR2025) hors de portée des enfants. En cas d'ingestion accidentelle, consultez immédiatement un médecin.
- Mantenga la pila (CR2025) del respaldo de datos fuera del alcance de los niños. En caso de que alguien ingiera accidentalmente la pila, consulte inmediatamente a un médico.

< Main Specifications of the Data-Back >

Format: Built-in quartz clock with LCD display (auto-calendar) print modes, "year-month-day", "day-hour-minute", ". . . ." (no date), "month-day-year", "day-month-year"

Date printing method: Automatic printing of date in linked action with shutter.

Film sensitivity setting: Automatic setting

Power source: 3V lithium battery (CR2025)

Measurements: 102 (W) × 59 (H) × 15 (D) mm

< Datenrückwand/Technische Daten >

Typ: Quarzkontrolle für Datum und Uhrzeit, LCD-Kontrollanzeige.

Funktionen: "Jahr-Monat-Tag", "Tag-Stunde-Minute", ". . . ." (keine Datierung), "Monat-Tag-Jahr", "Tag-Monat-Jahr".

Belichtungsfunktion: Automatisch mit Verschlußauslösung.

Abstimmung auf Filmempfindlichkeit: Automatisch

Stromquelle: 1 × 3 Volt Lithiumbatterie (Typ CR2025)

Abmessungen: 102 × 59 × 15 mm

< Spécifications principales du dos dateur >

Format: Horloge au quartz intégrée avec écran LCD (calendrier automatique)

Mode d'impression: "année-mois-jour", "jour-heure-minute", ". . . ." (pas de date), "mois-jour-année", "jour-mois-année"

Méthode d'impression de la date: Impression automatique de la date asservie au déclencheur

Réglage de la sensibilité du film: Réglage automatique

Source d'alimentation: Pile au lithium 3 V (CR2025)

Dimensions: 102 (L) × 59 (H) × 15 (P) mm

< Especificaciones principales del respaldo de datos >

Formato: Reloj de cuarzo incorporado con visualizador de cristal líquido (LCD) (calendario automático)

Modo de impresión: "año-mes-día", "día-hora-minutos", ". . . ." (sin fecha), "mes-día-año", o "día-mes-año"

Método de impresión de la fecha: Impresión automática en acción sincronizada con el obturador.

Ajuste de la sensibilidad de la película: Automático

Alimentación: Pila de litio de 3V (CR2025)

Dimensiones: 102 (An) × 59 (Al) × 15 (Prf) mm

<Microcomputer protection circuit >

This camera incorporates a safety circuit to protect its microcomputer against strong external static electricity. Though rarely, it may fail to function because this safety circuit has come into action. In this case, set the main switch to OFF, remove the battery, reload them and use the camera again.

<Schutzschaltung für Mikrocomputer >

Die empfindliche Mikroelektronik der Camera wird durch eine spezielle Schutzschaltung vor Zerstörung durch elektrostatische Aufladung geschützt. Wird diese Schutzschaltung aktiviert, so ist die Camera nicht mehr funktionsfähig. Unterbrechen Sie den Batteriestromkreis über den Hauptschalter und entnehmen Sie die Kamerabatterie. Zur Inbetriebnahme wieder Batterie einsetzen und die Camera einschalten.

<Circuit de protection du microprocesseur >

Cet appareil intègre un circuit de sécurité pour protéger son microprocesseur contre de l'électricité statique externe. Il arrive, rarement, que le circuit de protection entre en action et que le microprocesseur ne fonctionne plus. Dans ce cas, positionnez l'interrupteur principal sur OFF, retirez la pile, remettez la pile en place puis remettez l'appareil sous tension.

<Circuito de protección del procesador >

Esta cámara incorpora un circuito que protege su procesador contra electricidad estática externa intensa. Es posible que, raramente, la cámara no funcione debido a la activación de este circuito protector. En tal caso, ponga el interruptor principal en OFF, extraiga la pila, vuelva a colocarla y a poner el interruptor principal en ON, y pruebe a emplear otra vez la cámara.

Main Specifications

Type: 35 mm lens shutter auto-focus AE camera with built-in flash.

Picture Size: 24 × 36 mm.

Lens: Carl Zeiss Sonnar T* 38 mm F2.8 (5 elements in 4 groups).

Aperture Scale: F2.8 to 16.

Focusing Range: 0.7 m ~ ∞.

Shutter Type: Aperture priority program AE type electromagnetic shutter.

Shutter speeds: In program AE: 1~1/500 sec./ In aperture priority: Less than 1~1/200 sec. (the maximum shutter speed is changed according to the aperture setting). *Auto bulb beyond 1 sec./ With Flash: 1/30~1/500 sec.

Self-timer: Electronic type, 10 second delay, can be stopped midway.

Exposure Control: Aperture priority program AE.

Metering Range (ISO100): EV3 ~ EV17.

Metering System: External metering system with SPD cell.

Exposure Compensation: ±2EV (0.5EV steps).

Film Sensitivity: Set automatically (DX method), linked operations with ISO25~5,000 Set to ISO100 for films other than DX films.

Focusing Method: Auto-focus with focus dial. Possible to switch to manual focus.

Rangefinding Method: Infrared ray active method.

Viewfinder Type: Inverted Galilean finder with Albada type bright picture frame. Magnification and field of view: 0.6 ×, 85% (∞).

Viewfinder Display: Picture frame (including close-range picture frame), focus frame (including close-range focus frame), shutter speed, exposure compensation mark, focus display, flash mark, program mark, self-timer operation display.

Flash: Flashmatic system (red-eye reduction prelighting function included)/ Photographic distance: 0.7 m to 3 m (ISO100)/Charging time: Approximately 3.5 sec. (at normal temperature using a new battery).

Film Loading: Auto-loading method (including automatic film advance mechanism).

Film Advance: Automatic film advance.

Film Rewind: Auto-return/auto-stop mechanisms, also possible to rewind midway through a roll of film.

Technische Daten

Film Counter: LCD display, auto-resetting additive type, remaining time on self-timer, display of time elapsed for bulb exposure.

Camera Back: Opened and closed with camera back release knob. Camera back is removable.

Power source: Uses a 3V lithium battery (CR123A or DL123A). Possible to take approximately 25 rolls of 24-frame film when flash is used for half of the total (with new battery at normal temperature under standards specified by Kyocera).

Dimensions: 119 (W) × 66 (H) × 33 (D) mm.

Weight: 295 grams (without battery).

** Specifications and design are subject to change without notice.*

Typ: 35 mm Kompaktkamera mit Autofocus, motorischem Filmtransport und integriertem Blitz.

Filmformat: 24 × 36 mm.

Objektiv: Carl Zeiss Sonnar T* 2,8/38 mm, 5 Linsen in 4 Gruppen.

Blendenbereich: F2,8 ~ 16.

Entfernungsbereich: 0,7 m ~ ∞.

Verschluss: Zentralverschluss, stufenlos elektronisch gesteuert.

Zeitenbereich: Bei Programmautomatik: 1~1/500 Sek. / Bei Blendenvorwahl: 1~ca. 1/200 Sek., B (automatisch)

Blitz-Synchrozeit: 1/30~1/500 Sek.

Selbstausröser: Elektronisch, 10 Sek. Vorlaufzeit, unterbrechbar. LED-Blinksignal.

Belichtungskontrolle: Programmautomatik oder Zeitautomatik nach Blendenvorwahl.

Meßbereich: EV 3 ~ 17 (ISO 100).

Meßsystem: Extern, Si-Fotodiode im Objektivfront-ring.

Belichtungskorrektur: ±2 EV in 0,5 EV Stufen.

Free Manuals Download Website

<http://myh66.com>

<http://usermanuals.us>

<http://www.somanuals.com>

<http://www.4manuals.cc>

<http://www.manual-lib.com>

<http://www.404manual.com>

<http://www.luxmanual.com>

<http://aubethermostatmanual.com>

Golf course search by state

<http://golfingnear.com>

Email search by domain

<http://emailbydomain.com>

Auto manuals search

<http://auto.somanuals.com>

TV manuals search

<http://tv.somanuals.com>