

DESCRIPTION

Recessed lens directional luminaire with 4 inch square aperture utilizing a low voltage MR16 tungsten-halogen lamp. Modular platform can be reconfigured from below the ceiling to accept a broad range of lamp modules and optical elements. Platform is suitable for direct contact with insulation and 2x8 residential construction. Platform + module + element combination supports various lamp beam spreads for desired optical distribution with excellent light control and low aperture brightness.

Catalog #		Type
Project		
Comments		Date
Prepared by		

SPECIFICATION FEATURES

Frame

Galvanized steel plaster frame with integral bar hanger receivers. Set-screws provide positive horizontal locking.

Collar

Matte black steel collar adjusts vertically for 1/2" - 1" thick ceilings and can be rotated +/- 7.5° thru the aperture. Integral gun sights facilitate the use of guide strings or laser lines. Shipped with a paint overspray protector installed in the collar.

Lamp Module

Installed or removed thru the aperture or from the top at 0°, 90°, 180° and 270° positions. Hot aiming rotates 365°, tilts 45° and locks in position using #2 Philips screwdriver. Translating center beam optics aligns axis of lamp with aperture as lamp translates from nadar thru 45°.

Housing

Double wall aluminum housing painted matte black for a visually dark interior. Removable hinged top allows for top access. All fasteners are captive.

Gaskets

Closed cell gaskets achieve restrictive airflow requirements without additional caulking.

Optical Element

Mousetrap type springs pull flange tight to ceiling. Light trap eliminates spill light at edge of flange and reflector. Available in self-flanged or metal trim ring versions.

Bar Hangers

Captive preinstalled bar hangers adjusts from 8-1/2" to 24" wide; pass thru feature allows shortening without removal. Captive nail penetrates standard and engineered lumber. Mounting flange levels platform with ceiling. Integral clip attaches directly to t-bar.

Lower Reflector

Aluminum angle cut parabolic shielding prismatoid with clear lens is available in a wide range of semi specular Alzak(tm) finishes. Corrugated Baffle: An optional embossed pattern that extends through the flange adding a subtle design element and reduces aperture brightness.

Junction Box

(7) 1/2" trade size pry outs, (3) integral clamps for non-metallic cable. Rated for (4) #12 thru branch circuits. Wago® type push wire connectors for field connections.

Thermal Protector

Self-resetting thermal protector protects against improper lamping.

Transformer

Integral dual output toroidal magnetic transformer, 120V 50/60Hz input, 12V nominal 75VA maximum output. Separate output for circuits controlled by dimmers compensates for losses in dimmers, improves color temperature and lumen output.

Lamp Capsule

Ceramic GX5.3 lamp holder mounts to an aluminum heat sink to dissipate heat. Connects to the transformer with electrical quick connects. Accepts 2 lenses or filters.

Code Compliance

Thermally protected, IP labeled, cULus listed for wet locations and ASTM-E283 AIRTITE(tm). Suitable for direct contact with insulation.



**P408ICAT
MA4MR
E4AASR
E4AASRCB
50W MR16
Tungsten-Halogen**

4 Inch Square Lens Directional

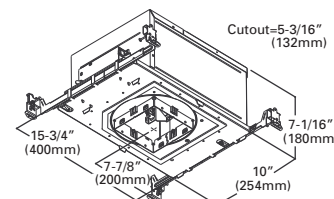
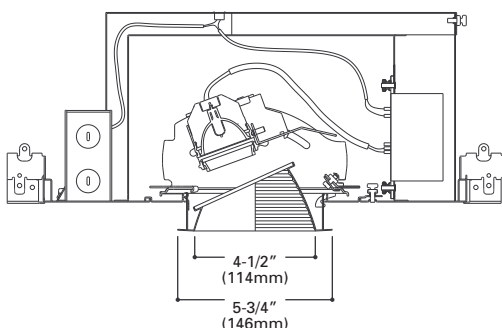

ENERGY DATA		
Lamp Wattage (Nominal)	Input Power (Watts)	Input Current (Amps)
20	21	0.17
35	37	.031
37	39	0.32
42	44	0.37
50	53	0.44

ORDERING INFORMATION: Complete unit consists of platform, lamp module and optical element.

Platform	Lamp Module	Optical Element	Finish	Flange	Accessories
P408ICAT	MA4MR				
P408ICAT = 4" Square Aperture IC Housing	MA4MR = MR16 Directional Lamp Module, 120V Input	E4AASR = 4" Square Aperture Angle Cut Lower Shielding Prismatoid, Lens E4AASRCB = 4" Square Aperture Corrugated Angle Cut Lower Shielding Prismatoid, Lens	Alzak® Finishes H = Clear Haze WMH = Warm Haze WHH = Wheat Haze KH = Cognac Haze GPH = Graphite Haze CTH = Cobalt Haze CCH = Chocolate Haze BH = Black Haze Painted Finishes MW = Matte White MB = Matte Black	[Blank] = Metal Trim Ring, Matte White SF = Self Flanged SFWF = Self Flanged, Matte White Flange (SFWF not available with corrugated baffle)	EDC4x41 = Extended depth collar for 1" - 1-1/2" thick ceilings EDC4x42 = Extended depth collar for 1-1/2 - 2" thick ceilings L4X4LNR = Skytek linear spread lens L4x4SF = Solite soft focus lens L4x4SPD = Crystal #73 prismatic spread lens MTR4MW = Metal trim ring, matte white MTR4MB = Metal trim ring, matte black MTR4SN = Metal trim ring, satin nickel MTR4AC = Metal trim ring, antique copper MTR4TBZ = Metal trim ring, tuscan bronze L Series - Filter Media For MR16 lamps (See Accessories specification sheet)

PHOTOMETRICS

Trim: **E4AASRH**
Lamp: **42MR16VNSP9**



0° Horizontal Aiming

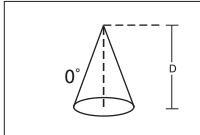

D	FC	Beam Dia
8'0"	113	1.1
9'0"	89	1.2
10'0"	72	1.3
13'0"	43	1.8
15'0"	32	2.0

30° Horizontal Footcandles

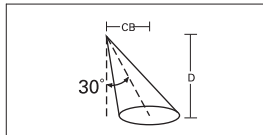

D	FC	L	W	CB
8'0"	77	1.7	1.2	4.6
9'0"	61	1.9	1.3	5.2
10'0"	49	2.1	1.5	5.8
13'0"	29	2.7	1.9	7.5
15'0"	22	3.1	2.2	8.7

30° Vertical Footcandles

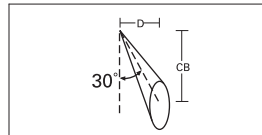

D	FC	L	W	CB
2'0"	262	1.1	0.6	3.5
3'0"	116	1.6	0.8	5.2
4'0"	66	2.1	1.1	6.9
5'0"	42	2.7	1.4	8.7
6'0"	29	3.2	1.7	10.4

45° Vertical Footcandles

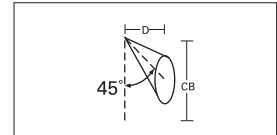

D	FC	L	W	CB
2'0"	704	0.6	0.4	2
3'0"	313	0.9	0.6	3
4'0"	176	1.2	0.8	4
5'0"	113	1.5	0.9	5
6'0"	78	1.8	1.1	6

Trim: **E4AASRH**
Lamp: **50WMR16 IR SP10**



0° Horizontal Aiming

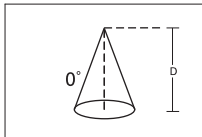

D	FC	Beam Dia
8'0"	163	1.3
9'0"	129	1.5
10'0"	105	1.6
13'0"	62	2.1
15'0"	46	2.5

30° Horizontal Footcandles

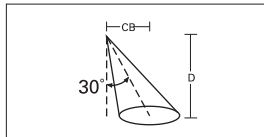

D	FC	L	W	CB
8'0"	98	2.0	1.7	4.6
9'0"	77	2.2	1.9	5.2
10'0"	62	2.5	2.1	5.8
13'0"	37	3.2	2.7	7.5
15'0"	28	3.7	3.1	8.7

30° Vertical Footcandles

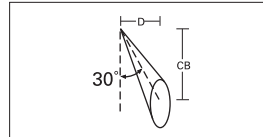

D	FC	L	W	CB
2'0"	348	1.3	0.7	3.5
3'0"	155	1.9	1.0	5.2
4'0"	87	2.5	1.4	6.9
5'0"	56	3.2	1.7	8.7
6'0"	39	3.8	2.0	10.4

45° Vertical Footcandles

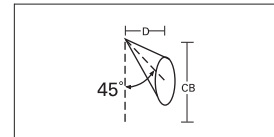

D	FC	L	W	CB
2'0"	861	0.7	0.5	2
3'0"	383	1.1	0.8	3
4'0"	215	1.4	1.1	4
5'0"	138	1.8	1.3	5
6'0"	96	2.1	1.6	6

Free Manuals Download Website

<http://myh66.com>

<http://usermanuals.us>

<http://www.somanuals.com>

<http://www.4manuals.cc>

<http://www.manual-lib.com>

<http://www.404manual.com>

<http://www.luxmanual.com>

<http://aubethermostatmanual.com>

Golf course search by state

<http://golfingnear.com>

Email search by domain

<http://emailbydomain.com>

Auto manuals search

<http://auto.somanuals.com>

TV manuals search

<http://tv.somanuals.com>