

OWNER'S INSTRUCTION MANUAL



Colleague CALLER ID TYPE II MULTI-FEATURE TELEPHONE

CORTELCO

**THANK YOU
FOR PURCHASING THE
COLLEAGUE CALLER ID TYPE II
MULTI-FEATURE TELEPHONE**

We want you to know all about your new Colleague Telephone, how to install it, the features it provides, and the services you can expect from its use. We have included this information in your Owner's Instruction Manual.

**PLEASE READ BEFORE INSTALLING
AND USING YOUR NEW TELEPHONE EQUIPMENT.**

TABLE OF CONTENTS

IMPORTANT SAFETY INSTRUCTIONS	2
TELEPHONE USAGE	4
SETUP/INSTALLATION	4
WALL MOUNT INSTRUCTIONS	5
UNIT SETUP	5
FACTORY PRESETS	5
TELEPHONE PART IDENTIFICATION	7
TELEPHONE FEATURES	8
PULSE AND TONE DIALING	8
RECEIVING A PHONE CALL	8
PLACING A PHONE CALL	8
SPEAKERPHONE BUTTON	8
DURATION COUNTER	9
TONE BUTTON	9
AUTOMATIC MEMORY	9
TO STORE A PHONE NUMBER IN MEMORY	9
TO DIAL A PHONE NUMBER IN MEMORY	10
VOLUME BUTTON	10
REDIAL BUTTON	10
PAUSE BUTTON	10
HOLD BUTTON	11
FLASH BUTTON	11
DATA PORT	11
CALL WAITING DISPLAY	11
CALLER ID FEATURES	12
MESSAGE LIGHT	12
MESSAGED WAITING	12
RECEIVING CALLS	13
REVIEWING CALLS	14

DELETING CALLS	14
CALLBACK... ..	15
DIAL OPTIONS BUTTON	15
MESSAGE ERROR	17
NO DATA SENT	17
PRIVATE CALLS	17
UNKNOWN CALLS	18
TELEPHONE SERVICE PROBLEMS	19
MAINTENANCE INFORMATION	20
TELEPHONE REPAIR	21
FCC INFORMATION	22
INDEX	23

IMPORTANT SAFETY INSTRUCTIONS

Always follow basic safety precautions when using your telephone equipment to reduce the risk of fire, electrical shock, and injury.

1. **Read and understand all instructions** in the Owner's Instruction Manual.
2. **Read all warnings** and follow all instructions marked on the product.
3. **Unplug this product from the wall outlet before cleaning.** Use a damp cloth for cleaning. Do not use liquid or aerosol cleaners.
4. **Do not use the telephone near water.** For example, do not use near a bathtub, wash bowl, kitchen sink, laundry tub, swimming pool, or in a wet basement.
5. **Do not place this product on an unstable cart or stand.** The product may fall causing serious damage to the product.
6. **Use only the type power source indicated on the label.** If you are not sure of the type power supply to your home, consult your dealer or local power company.
7. **Do not place any objects on the telephone line cord.** Do not locate the telephone where the line cord will be walked on.
8. **Do not block or cover ventilation slots and openings** in the bottom of the telephone. The openings should never be blocked by placing the telephone on a bed, sofa, rug, or other similar surfaces. The telephone should never be placed near or over a radiator or heat register. The telephone should never be placed in a built-in installation unless proper ventilation is provided.
9. **Never spill liquid on the telephone or push objects of any kind through ventilation slots.** Liquid or objects may touch dangerous voltage points or short out parts that could result in a risk of fire or electrical shock.

10. **Do not disassemble this product.** Opening or removing covers may expose you to dangerous voltages or other risks. Incorrect reassembly can cause electrical shock when the product is subsequently used.
11. **Do not overload outlets and extension cords.** Some telephones require AC power from an outlet. Overloading the outlets can result in the risk of fire or electric shock.
12. **Avoid using a telephone during a local thunderstorm.** There may be a remote risk of electrical shock from lightning.
13. **Do not use a telephone to report a gas leak in the vicinity of the leak.**
14. **Unplug the telephone from the wall outlet and refer servicing to qualified service personnel** under the following conditions:
 - When the line cord is frayed or plugs damaged.
 - If liquid has been spilled into the telephone.
 - If the telephone has been exposed to rain or water.
 - If the telephone does not operate properly by following the operating instructions. (Adjust only those controls covered by the operating instructions. Improper adjustment of other controls may result in damage and will often require extensive work by a qualified technician to restore the product to normal operation.)
 - If the telephone has been dropped or the housing damaged.
 - If the telephone exhibits distinct change in performance.

SAVE THESE INSTRUCTIONS

15-101-613

TELEPHONE USAGE

SET UP/INSTALLATION

1. Connect the adapter. Plug the large part of the adapter into the wall outlet and the adapter tip to the jack at the rear side of unit. (Use only 9V DC, 200mA, center positive Class 2 adapter.)
2. Connect the telephone line cord.
 - a. To connect without an answering machine.
 - Use the new line cord to connect the PHONE jack of your new caller ID phone to the modular wall jack.

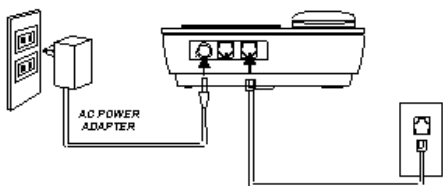

- b. To connect with an existing answering machine.
 - Use the existing line cord supplied to connect the LINE jack of your answering machine to the wall modular line jack.
 - Use the new line cord supplied to connect the telephone's jack of your new Caller ID phone to the PHONE jack of your answering machine.
 - Set your answering machine to answer the phone after 2 or more rings.

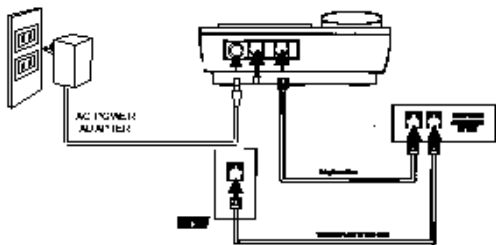

3. Follow the procedure "Unit Setup" to set up your unit.
4. Place the unit on a flat table or mount it on a wall. If you desire to place it on a wall, use the wall mount bracket and short line cord supplied to accomplish the wall mounting.

WALL MOUNT INSTRUCTIONS

1. Install wall mount bracket in wall mount position and route cords as shown in diagram below.
2. Connect the adapter and the line cord. See Steps 2 & 3 on preceding page for specific instructions.
3. Push out the handset hook and reattach in opposite direction for the wall mount position, plug the coiled cord into the handset, and then plug the other end of the cord into the base.
4. Place the handset on the base.

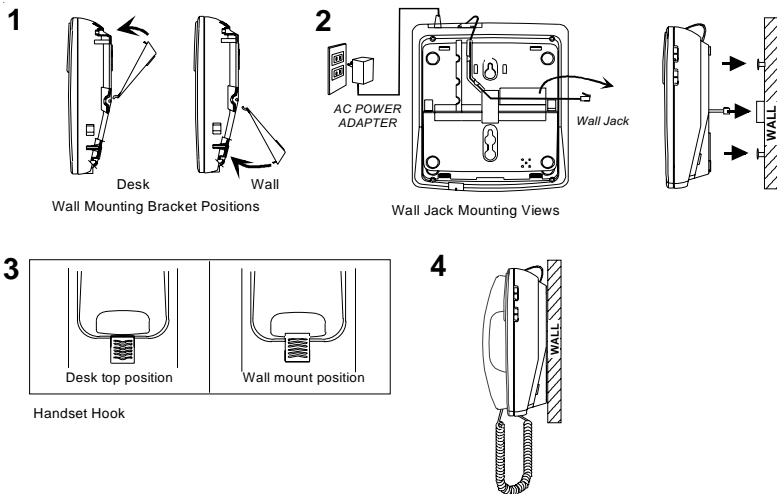

UNIT SETUP

FACTORY PRESETS

The following table shows you the factory settings for your unit:

<u>Display</u>	<u>Setting</u>
Language	English
LCD Contrast	1
Area Code	no setting
LDS Code	1

After the adapter is connected, the display will show as indicated below for setting.

1. [SET LANGUAGE] appears on the display. Press the **REVIEW UP** (▲) button to select the language. E - English, F - French, S - Spanish, and then press the **DIAL** button to confirm the selection.



2. When [LCD CONTRAST] appears, press **REVIEW UP** (▲) button to set the contrast darker, and then you can press **REVIEW DOWN** (▼) button to set the contrast back to the preset.

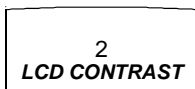

3. When [SET AREA CODE] appears, use **REVIEW UP** (▲) button and **REVIEW DOWN** (▼) button to set your local area code.



REVIEW UP (▲) button - to change the digit from -. 0, 1, 2, -9

REVIEW DOWN (▼) button - to move to the next digit.

When you are finished setting the local area code, press **Dial**.

4. When [SET LDS CODE] appears, press **REVIEW UP**(▲) button to change the long distance code from -, 0, 1, 2, -9. When you are finished, Press **DIAL**. The display will indicate as shown (Stand-By Screen) and be ready to receive incoming calls. You have to set the LDS code as 1 when you are in the USA or Canada.

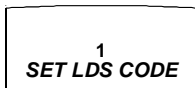

Stand-By Screen

5. The time and date are automatically set when a caller ID (CID) number is received. The unit will keep the current time accurately, and is updated each time a CID number is received.



After you have set up the unit completely for the first time, use the **MENU** button to review or reprogram the Language, Area Code or LDS Code.

TELEPHONE PART IDENTIFICATION

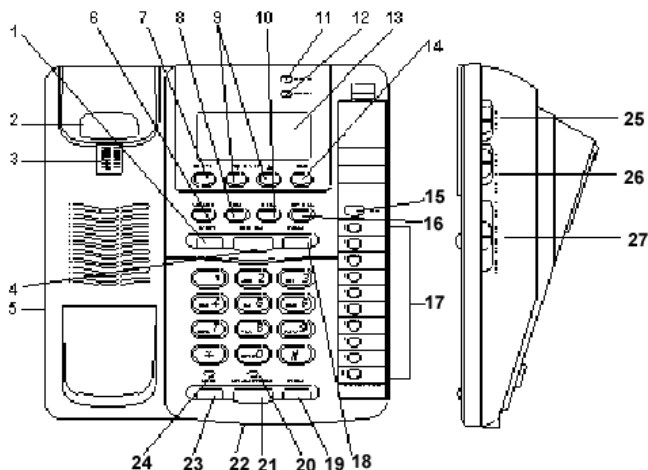

1	Store Button	15	Flash
2	Hook Switch	16	Options Button
3	Handset Hook	17	10 Auto Memory Button
4	Memory Dial Button	18	Pause Button
5	Handset Cord Jack	19	Redial Button
6	Volume Button	20	Speakerphone LED
7	Delete Button	21	Speakerphone Button
8	Tone Button	22	Memory Index
9	Review Up/Down Button	23	Hold Button
10	Menu Button	24	Hold LED
11	Red New Call LED	25	Pulse/Tone Switch
12	Green New Message	26	Ringer Off/Hi/Low Switch
13	LCD Display	27	Speaker Off/Hi/Low Switch
14	Dial Button		

TELEPHONE FEATURES

PULSE AND TONE DIALING

1. If your telephone line accepts a touch-tone dialing, set the **PULSE/TONE** switch to the Tone position.
2. If your telephone line requires a rotary (pulse) dialing, set the **PULSE/TONE** switch to the Pulse position.
3. If you are unsure which system you have, set the switch to the **TONE** position. Lift the handset. When you get a dial tone, dial a telephone number. If the dial tone continues, move the switch to **PULSE**, and then dial the telephone number again.

Note: *In order for the Caller ID callback to work (see Using the Caller ID Function), you must set the **PULSE/TONE** switch to the Tone position.*

RECEIVING A PHONE CALL

1. Be sure the **RINGER** switch is set to the **HI** or **LOW** position.
2. When the phone rings and the caller's information shows on the display window (refer to Using the Caller ID Function), lift the handset or press the **SPEAKERPHONE** button and begin your conversation.
3. Set the Ringer switch to the **OFF** position when you do not want to be interrupted by the phone ringing. Remember to set the ringer switch back to Hi or Low when you want to receive calls again.

PLACING A PHONE CALL

1. Lift the handset or press the **SPEAKERPHONE** button and wait for a dial tone.
2. Dial the telephone number you wish to call. The number will appear on the display window.

SPEAKERPHONE BUTTON (AC Adaptor must be used to ensure proper function)

1. Receiving Incoming Calls
 - a. When the phone rings and the caller's information shows on the display window (refer to *Using the Caller ID Function*), press and release the Speakerphone button and talk normally into the built-in microphone from a distance of 5-6 inches.

- b. You can adjust the volume of the caller's voice by sliding the **VOLUME CONTROL** on the right side of the phone. '
 - c. After the conversation has finished, press the **SPEAKERPHONE** button to hang up.
2. To Make A Call
 - a. Press and release the **SPEAKERPHONE** button.
 - b. When you hear a dial tone, dial the number or press the auto memory button just as you would on any other push-button telephone. The number will appear on the display window.
 - c. When your party answers, adjust the sound level of his or her voice by sliding the **VOLUME CONTROL** located on the right side of the phone.
 - d. After the conversation has finished, press **SPEAKERPHONE** to hang up.

Note:

1. *If you wish to switch from speakerphone to handset, simply lift the handset.*
2. *If you wish to switch from handset to speakerphone, press and release **Speakerphone** and then hang up the handset.*

DURATION COUNTER

A built-in counter will start counting from your reference 6 seconds after you lift the handset or 6 seconds after you dial a telephone number.

TONE BUTTON

If the **PULSE/TONE** switch is set to the **PULSE** position, and you want to make a tone entry (ex. telephone number into pager) after pulse dialing, press the **TONE** button once, then dial the number. The number dialed out will be changed to tone dialing automatically without setting the **PULSE/TONE** switch to **TONE** position.

AUTOMATIC MEMORY

To Store A Number In Memory:

1. Press the **STORE** button, [**MEMORY STORING**] appears on the display window.
2. Dial the telephone number (15 digits maximum) to store in **memory**.
Note: The memory locations can be chained together to store numbers of longer length.
3. Press **STORE** again.

4. Press the desired memory location.
 - To store in an auto memory button (located on right-hand side of base) - Press 1, 2, 3, or 10).
 - To store in a keypad memory location - Press one of the keypad buttons (1, 2, 3, or 0).
5. Use pull out memory index to write in name and the memory button where it is stored.

To Dial A Phone Number In Memory

1. Lift the handset and wait for a dial tone.
2. Press any memory location.
 - To dial an auto memory button (located on right-band side of base) - Press the desired auto memory button (1, 2, 3.... or 10).
 - To dial a keypad memory location - press the **MEM DIAL** button first, and then the desired keypad button (1, 2, 3.... or 0).
3. The number will be displayed and dialed automatically.

VOLUME BUTTON

A built-in amplifier feature allows you to increase the listening volume in the receiver of the handset when speaking with your party. When needed, press the **VOLUME** button to achieve three different levels. The volume will go back to normal after you hang up the handset.

REDIAL BUTTON

1. If the number you dialed is busy, or you want to call the last number dialed again, lift the handset, or press and release the hookswitch for a new dial tone.
2. Press **REDIAL**. The number will appear on the display window.
3. The last number called (31 digits maximum) will automatically be redialed.

PAUSE BUTTON

The **PAUSE** button allows you to insert a 3.6-second pause in the dialing sequence. This is particularly useful if you are connected to a PABX system where you must dial an access code (usually the number 9) to obtain an outside line.

1. Press the **PAUSE** button once and release at any point in the dialing sequence where a pause is desired.
2. The **PAUSE** button can be pressed more than once to create a longer pause.

HOLD BUTTON

1. To place a call on hold, press the **HOLD** button and hang up the handset. The **HOLD** Indicator will light up and remain lighted until you resume your conversation.
2. To resume your conversation, lift the handset or that of any extension phone on the same line or press and release **SPEAKERPHONE**. The **HOLD** indicator will go out and your call can continue.

FLASH BUTTON

This telephone provides a line break signal for accessing PABX service or for convenient use of Call Waiting from your local telephone company. If you have Call Waiting service, you can alternate the Call Waiting function per the following instructions.

1. While having a conversation, another party calls and you hear a tone.
2. Press the **FLASH** button once and release. The first conversation is placed on hold and the second call can be answered.
3. Press **FLASH** button again and release. The first caller can be spoken to again and the second call is placed on hold.

DATA PORT

This is a connection which is in parallel with the telephone line. It allows the connection of a device such as a modem, caller ID, or an answering machine.

CALL WAITING DISPLAY

In the past, if you had call-waiting service, a tone alerted you there was a new call coming while you were on an existing call.

Now our Call Waiting Caller ID not only tells you there is another call waiting, but lets you know who the caller is before you answer it. The call waiting information will be shown on the unit's display.

The **CALL WAITING** (CW) symbol will flash for 16 seconds along with the telephone number and name of the person who is on call waiting. Press the FLASH button to put the existing call on hold and answer the new call.

No matter whether you answer the call or not, the Call Waiting Caller ID will store the call information for future reference.

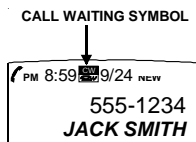

Note: Make sure you have subscribed to both Call Waiting Caller ID and Caller ID service from your local telephone company. If you only have Caller ID service, the unit works for Caller ID only.

CALLER ID FEATURES

MESSAGE LIGHT

An indicator marked **NEW CALL** will light up to let you know when there are new calls received.

If you have a voice mailbox service with your telephone company, another indicator marked **MESSAGE** will flash to alert you to dial your telephone company to check your new messages.

The **MESSAGE** indicator also monitors the unit's situation. When the phone is in use, the **MESSAGE** indicator will be on continuously. If the indicator is flashing quickly, it means the phone is ringing. If it is not ringing and the light is flashing, the unit has experienced a power outage.

MESSAGE WAITING

This unit's **MESSAGE WAITING DETECTION** is for both FSK and Stutter Tone Systems.

IF YOUR SERVICE IS FSK:

1. If you have a voice mailbox service from the phone company, the **MESSAGE** indicator will flash and **[MESSAGE WAITING]** will appear on the display for 20 seconds when a message waiting signal (on) from the Central Office is received.
2. The **MESSAGE** indicator will go off and **[MSG WAITING OFF]** will appear for 20 seconds if the message waiting off signal is sent from the Central office.

IF YOU ARE IN AN AREA WHERE AN FSK SIGNAL IS NOT AVAILABLE:

1. This unit will check your line for a stutter dial tone every time you hang up or each time a call goes unanswered. The **MESSAGE** indicator will flash when there is a message waiting.
2. You may experience some delay in seeing the **MESSAGE** indicator light up even though there are messages in your mail box. This delay is due to regulatory matters and does not indicate a problem with the unit.

This unit may not be activated or deactivated under certain conditions. For example, when you retrieve your message from an outside phone (not your own telephone number), the **MESSAGE** indicator may not be canceled when you return home. If you experience this situation, pick up the receiver and hang up. The **MESSAGE** indicator will cancel.

RECEIVING CALLS

1. When the telephone is not in use and a new call is received, the display will show the **NEW** symbol, the phone number, the caller's name, and time and date of the call for 20 seconds. The **RPT** (repeat) symbol will appear if the call has come in more than once.

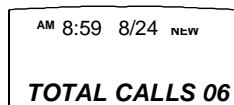
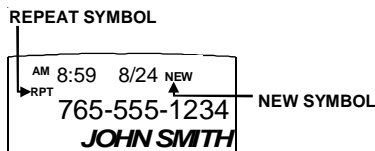

2. After 20 seconds with no activity, the display will default to the Stand-By screen and remain on until another call is received or a button is pressed. This will show you the total number of calls stored and how many new calls that have not been reviewed.

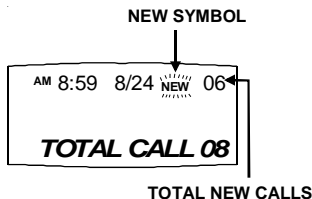

REVIEWING CALLS

1. When the **NEW** symbol is flashing on the Stand-By screen, you have new incoming calls. Next to the **NEW** symbol is the total number of new calls. Press the **REVIEW UP** (▲) or **REVIEW DOWN** (▼) button to review the incoming stored calls.
2. The **NEW** symbol attached to each call will be removed after you review the call.
3. If the **NEW** symbol is still flashing when the display goes back to the Stand-By screen, there are new calls that you have not yet reviewed.
4. The reviewed number can be stored into any of the auto memory buttons or keypad memory locations by pressing the **STORE** button first, then one of the memory buttons
5. When you have reached the end of the call records, the display will indicate [-**END OF LIST**-], confirming there are no more calls stored.



- **END OF LIST** -

Note: If the telephone number received is more than 10 digits, the unit will only store the first 10 digits into memory.

DELETING CALLS

1. To delete an individual call: When reviewing calls, you can delete an individual call by pressing the **DELETE** button once. The display will be erased line by line and the rest of the records will be renumbered.



703-555-1234
JOHN SMITH

2. To delete all calls: When reviewing calls, you can delete all calls by pressing and holding **DELETE** for more than 3 seconds. Then [**DELETE ALL**] will appear. Press **DELETE** to confirm you really want to erase all records. [**NO CALLS**-] appears on the display to show there are no calls stored in memory.

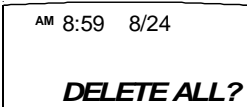

AM 8:59 8/24

DELETE ALL?

CALLBACK

When reviewing received calls, there are two ways to dial the telephone numbers shown on the display by pressing **DIAL**.

1. With the handset in its cradle (on-hook), press **DIAL**. [*PICKUP PHONE...*] will appear in the LCD display to ask you to pick up the handset. The number will be dialed after you pick up the handset.

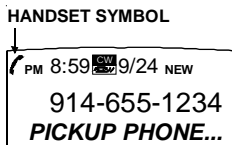

2. If you pick up the handset, review the calls, and press **DIAL**, the displayed number will be dialed immediately.

Note: The *HANDSET* symbol will light up in the upper left hand corner of the LCD display when the handset is picked up.

If [*SET AREA CODE*] appears prior to [*PICKUP PHONE...*] or dialing, it means you have not programmed the local *area code*. Please hang up the telephone and program the *area code*.

1. If a local call (a telephone number with the same area code as you set) is reviewed and its 7-digit number displayed, press **DIAL** to dial the number displayed.
2. If a long distance call (a telephone number with a different area code than you set) is reviewed and its 10-digit number (3-digit area code + 7-digit telephone number) is displayed, press **DIAL** to dial the number displayed.

The **OPTIONS** button allows you to change the format of the displayed number. The available format follows:

7-digit	7-digit telephone number.
10-digit	3-digit area code + 7-digit telephone number.
11-digit	long distance code 1 + 3-digit area code + 7digit telephone number.

If a local call, and its 7-digit number is displayed:

- Pressing **OPTIONS** once will change it to a 10-digit format (your area code + 7-digit number).
- Pressing **OPTIONS** twice will change it to an 11-digit number (1 + your area code + 7-digit telephone number).

- Pressing **OPTIONS** three times will go back to the original 7-digit telephone number. For example: Your area code is 205 and you are reviewing telephone number 785-2883. When the desired format of the telephone number is reached, press **DIAL** to dial the displayed number.

Original 785-2883	Press Option button once (205) 785-2883	Press Option button twice 1 + (205) 785-2883
PM 10:36 8/24 785 - 2883 DANIEL WHITE	PM 10:36 8/24 205 - 785 - 2883 DANIEL WHITE	PM 10:36 8/24 120 - 578 - 5288 DANIEL WHITE

*Note: Since the LCD can only display 10 digit telephone numbers, when you change the format to 11-digits, only the first 10 digits can be seen, but it will dial 11-digits after you press **DIAL**.*

If a long distance call, and its 10-digit number is displayed,

- Pressing **OPTIONS** once will change it to an 11-digit number (1+ 3-digit area code + 7-digit telephone number).
- Pressing **OPTIONS** twice will remove the 3-digit area code and change to display only the 7-digit telephone number.
- Pressing **OPTIONS** three times will go back to the original 10-digit number
- For example: your own area code is 205, and you are reviewing telephone number 914-656-5756.

When the desired format of the telephone number is reached, press **DIAL** to dial the displayed number.

Original (914) 656-5756	Press Option button once 1+(914) 656-5756	Press Option button twice 656-5756
PM 8:29 8/24 914 - 656 - 5756 SMITH JOHN	PM 8:29 8/24 191 - 465 - 6575 SMITH JOHN	PM 8:29 8/24 656 - 5756 SMITH JOHN

MESSAGE ERROR

- The display indicates [-ERROR-] if your unit receives a call that has an error in the transmission or reception.

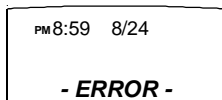

NO DATA SENT

1. [-NO DATA SENT-] will be displayed if there is no caller ID (CID) number sent from the telephone company while ringing.

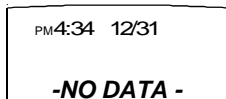

PRIVATE CALLS

- If the caller has exercised the option to block his number from being sent, [PRIVATE NUMBER] and his name will alternately display on the screen when this information is received.
- If the caller has exercised the option to block his name from being sent, [PRIVATE NAME] and his telephone number will be displayed on the screen.
- If the caller has exercised the option to block his name and number from being sent, then [PRIVATE CALLER] will be displayed on the screen.

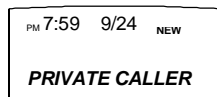
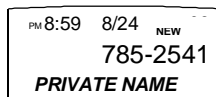
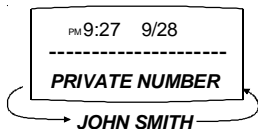

UNKNOWN CALLS

- When the telephone company is unable to provide information of the caller's telephone number, [UNKNOWN NUMBER] and his name will alternately display on the screen when this information is received.
- When the telephone company is unable to provide information of the caller's name, [UNKNOWN NAME] and his telephone number will be displayed on the screen.
- When the telephone company is unable to provide information of the caller's name and number, [UNKNOWN CALLER] will be displayed on the screen.

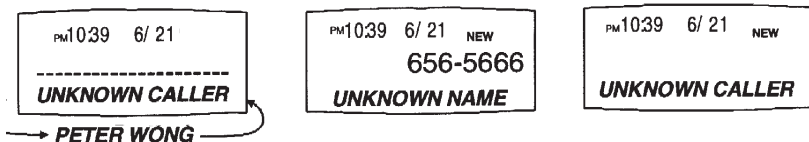

TELEPHONE SERVICE PROBLEMS

If you have any problems with your telephone equipment service, determine if the problem is with your unit or the telephone company lines. BEFORE CALLING THE TELEPHONE COMPANY, be aware that they may charge you for a service call if the problem is caused by your telephone equipment.

TROUBLESHOOTING

PHONE DOES NOT RING

1. **HI/LOW/OFF** ringer switch is set to **OFF** position
2. Line cord is disconnected at telephone outlet or at telephone end.
3. Phone is **OFF HOOK**. Make certain the hookswitch is depressed when the handset is in the cradle.
4. **SPEAKERPHONE** indicator is on. Turn off speakerphone.

NO DIAL TONE

Wire is disconnected at telephone jack or at wall jack. Test the telephone in a different wall jack. If it works, the first jack may be defective.

HAVE DIAL TONE BUT CANNOT DIAL OUT

Check if the **PULSE/TONE** switch is at the correct position.

REDIAL BUTTON DOES NOT FUNCTION

The telephone may have been momentarily disconnected from the telephone jack.

BLANK SCREEN

Check if the adapter is connected properly

CALLERS ARE NOT DISPLAYED ON THE SCREEN

1. Verify that you have subscribed to the appropriate service (Caller ID and Call Waiting Caller ID) from your telephone company. If you only subscribed to the Caller ID service this unit will not display the call waiting caller ID information.
2. Check if your answering machine is set to answer the call before 2 rings.

NO CALLER INFORMATION IS DISPLAYED WHEN HEARING THE CALL WAITING AUDIO SOUND

1. Verify that you have subscribed to the Call Waiting Caller ID service from your telephone company.

MESSAGE ERROR HAPPENS FREQUENTLY

1. Caller information was not transmitted properly. Check with your telephone company to see if there is a problem with your phone line.

Since our special design will always retain your stored call records, we encourage you to disconnect all the telephone cords and adapter; and then reinstall the unit step by step per this instruction manual before you ask for service.

SPECIAL NOTE: *The call records will not be erased when the adapter is disconnected. A special E2PROM design allows the unit to always retain your stored call records after you disconnect the adapter*

MAINTENANCE INFORMATION

Treat your telephone equipment with care for trouble-free performance. Avoid dropping the handset. Carefully place the handset on-hook after use.

Avoid putting near heating appliances and devices that generate electrical noise (for example, motors and florescent lamps).

Clean your telephone equipment with a damp cloth. Stains may be removed with a mild soap. Do not use liquid or aerosol detergents or cleaning agents.

Do not expose to direct sunlight or moisture

Retain the original package in case you need to ship it at a later date.

TELEPHONE REPAIR

DO NOT ATTEMPT TO REPAIR THIS PRODUCT YOURSELF. Call Waiting Caller ID Telephones manufactured by CORTELCO must be returned to us for repair.

You can return your telephone to CORTELCO for repair or replacement in accordance with our LIMITED WARRANTY.

CORTELCO warrants **THIS PRODUCT** against defects in material and workmanship in accordance with our LIMITED WARRANTY. If your telephone is returned for repair, include a copy of your sales receipt containing the date-of-purchase. **DO NOT INCLUDE THE ORIGINAL SALES RECEIPT.**

If date-of-purchase is not included, the factory date printed on the label on the bottom of your telephone will be used as the date-of-purchase. The factory date allows six months for distribution and sale of this product.

If you return your telephone for repair, the warranty period is not extended. The original date-of-purchase continues to apply to your warranty.

OUT-OF-WARRANTY REPAIR We will repair this product for a nominal fee after the LIMITED WARRANTY has expired if you send it to us in a complete and undamaged condition. The repaired Call Waiting ID will be shipped to you C.O.D., freight collect.

RETURN-FOR-REPAIR PACKAGING If you are returning a unit to us for repair, package it carefully, preferably in the original carton. Be sure to include your return address, a copy of the sales receipt showing date-of-purchase, and a note describing the problem you have with your Call Waiting Caller ID Telephone. Shipping must be prepaid. If the telephone is in warranty, it will be repaired or replaced, at our option, at no cost to you, and it will be returned shipping prepaid.

Ship your Call Waiting Caller ID (shipping prepaid) to:

CORTELCO REPAIR CENTER
1703 SAWYER ROAD
CORINTH, MS 38834

FCC INFORMATION

DESIGN COMPLIANCE Your telephone is designed to comply with FCC Rules and Regulations, Part 68. It can be connected to the telephone network as FCC-registered terminal equipment. The registration number is printed on the label on the bottom of your telephone.

NOTIFICATION TO THE TELEPHONE COMPANY As a customer of the local Telephone company, you must, if they ask, tell them before connecting your telephone to the telephone company lines. The telephone company may need the FCC registration number and the ringer equivalence of the telephone. This information is printed on a label on the bottom of your telephone.

RINGER EQUIVALENCE The ringer equivalence indicates the amount of power that your telephone draws from the telephone company line during ringing. The number is printed on the label on the bottom of your telephone.

If you have more than one telephone (or other terminal device) connected to the telephone company line, you should total the ringer equivalence numbers (REN s), and be sure that the total is not more than five. Your telephones may not ring if the total is more than five. Also, in some rural locations, your telephone may not ring if the REN total is more than three.

RESTRICTIONS You must not connect your telephone to coin-operated lines or party lines.

INTERFERENCE POTENTIAL Your telephone has a push-button dial that generates radio frequency energy. If not properly used, it may interfere with radio and television reception. If the telephone does cause interference with reception, move the radio or television to another electrical circuit or another location. If necessary, you may need to seek advice from an experienced technician.

INSTALLATION This model telephone must be connected to the telephone company lines through a modular jack. The required USOC for the modular jack is RJ11C for desk mounting and RJ11W for wall mounting. The USOC number is printed on the label on the bottom of your telephone.

TYPE OF DIALING Your telephone has a push-button TONE dial. You must have TONE service from your telephone company to use your telephone for dialing. Note that you will usually be charged extra for TONE service. If you do not have Tone service, you may use Pulse dialing.

HEARING-AID COMPATIBILITY The handset on your telephone will work with magnetically-coupled hearing aids. You can use a hearing aid equipped with a T (Telephone) switch.

IN CASE OF TROUBLE If your telephone should cause problems on the telephone line, the telephone company can temporarily disconnect your service. The telephone company must then notify and allow you to correct the problem.

The telephone company may from time to time change its lines or equipment. They must notify you if planned changes will affect your telephone service, to allow you to take steps to prevent interruptions.

INDEX

A		N, O		V	
Area Code	6	Options	15	Volume	10
Adjusting volume	10	One-touch dialing	10		
B,C		P		W, X, Y, Z	
Call Waiting	11	Part Identification	7	Warranty	25
Callback	15	Pulse dialing	8		
Caller ID Features	12	Pause	10		
		Private Calls	17		
D		Q, R			
Deleting calls	14	Receiving calls			
Dialing Mode		Telephone	8		
Choosing	8	Caller I.D.	13		
Switching to tone temporarily	9	Redial	10		
		Reviewing calls	14		
E, F		Repair	21		
Flash	11	S			
FCC Information	23	Safety	2		
		Setup	4		
G, H, I, J, K, L		Speakerphone	8		
Hold	11	T			
M		Tone dialing	8		
Making calls	8	Troubleshooting	19		
Memory	9				
Message light	12	U			
Message waiting	12	Unknown Calls	18		
Maintenance	20				

LIMITED WARRANTY

If you purchased this product new in the U.S. or Puerto Rico, **CORTELCO** warrants it against defects in material and workmanship for a period of one (1) year from the date of original purchase. This warranty is in lieu of all other express warranties. During the warranty period, **CORTELCO** agrees to repair or, at its option, replace the defective product, or any part of it without charge for parts or labor. This is your exclusive remedy. This warranty does not cover damage resulting from accident, misuse, abuse, improper installation or operation, lack of reasonable care, the affixing of any attachment not provided by **CORTELCO** with the product and loss of parts. The warranty is voided in the event any unauthorized person alters or repairs the unit.

Telephone companies use different types of equipment and offer various types of services to customers. **CORTELCO does not warrant that this product is compatible with the type of equipment of any particular phone company or the services provided by it.**

CORTELCO DISCLAIMS ANY IMPLIED WARRANTY, INCLUDING THE WARRANTY OF MERCHANTABILITY AND THE WARRANTY OF FITNESS FOR A PARTICULAR PURPOSE, AS OF THE DATE ONE YEAR FROM THE ORIGINAL PURCHASE OF THE PRODUCT. **CORTELCO** ASSUMES NO RESPONSIBILITY FOR ANY SPECIAL, INCIDENTAL OR CONSEQUENTIAL DAMAGES.

THIS WARRANTY GIVES YOU SPECIFIC LEGAL RIGHTS, AND YOU MAY HAVE OTHER RIGHTS WHICH VARY FROM STATE TO STATE. SOME STATES DO NOT ALLOW THE EXCLUSION OR LIMITATION OF SPECIAL, INCIDENTAL OR CONSEQUENTIAL DAMAGES OR LIMITATIONS ON HOW LONG AN IMPLIED WARRANTY LASTS, SO THE ABOVE EXCLUSION AND LIMITATION MAY NOT APPLY TO YOU.

If failure occurs and your Call Waiting ID is in warranty, service shall be provided by returning it to **CORTELCO - Repair Center, 1703 Sawyer Road, Corinth, Mississippi 38834, shipping prepaid**. The product will be repaired or replaced if examination by us determines the product to be defective. Call Waiting IDs received damaged as a result of shipping will require you to file a claim with the carrier.

2210
COLLEAGUE
Rev01

Free Manuals Download Website

<http://myh66.com>

<http://usermanuals.us>

<http://www.somanuals.com>

<http://www.4manuals.cc>

<http://www.manual-lib.com>

<http://www.404manual.com>

<http://www.luxmanual.com>

<http://aubethermostatmanual.com>

Golf course search by state

<http://golfingnear.com>

Email search by domain

<http://emailbydomain.com>

Auto manuals search

<http://auto.somanuals.com>

TV manuals search

<http://tv.somanuals.com>