

Coway

Air Purifier AP-1005AH User's Manual

Do not fail to read this user's manual before you use this air cleaner and keep it within ready reach.

Looks Good 

Easy 

Smart 



- This product can not be used if the voltage is different from that mentioned in the rating plate.
- The Letter of Guarantee is enclosed here with this Coway product realizing "Quality is the best policy".

DEAR CUSTOMERS

First of all, we would like to thank you very much for purchasing this Coway air cleaner. This product is superior to the ones in the past in function and we believe that it will provide you with clean and healthy air. We would like to recommend you to read this User's Manual carefully for proper operation and maintenance and keep this manual well together with the warranty. This user's manual could solve your problem resulted from that you can easily fix yourself in just a few minutes.



CONTENTS

1. Safety Information

Electricity Safety	03
Installation Safety	04
Operation Safety	05

2. Operating Instructions

Features	07
Names of Each Part	09
Names of Internal Filters	11
Operation Part/Indication Part	12
Preparations	13
How to Use	15
Cleaning Method	18
Filter Cleaning Method	20
Filter Replacement	21
Installation Method	24

3. Troubleshooting Tips

Before Asking A/S	26
-------------------------	----

4. Customer Service

Specifications	28
Warranty Information	29

SAFETY INFORMATION



Please read this information to prevent property loss and ensure your safety.



Danger

If not observed, serious injury or even death could occur.



Warning

If not observed, serious injury or property damage could occur.



Notice

If not observed, slight injury or property damage could occur.



SAFETY INFORMATION

Please read this information to prevent property loss and ensure your safety.

Electricity safety



Danger

Only connect the power cord to the voltage rating that matches it on the rating plate.

It may cause an electric shock or a fire.



Do not connect or work on power cable at your disposition. In case power cable is broken, make sure not to change the cable at discretion and contact Service Center.

It may cause an electric shock or a fire.



Be sure to take plug out during repair, maintenance, cleaning and parts change. Do not touch the product with a wet hand.

It may cause an electric shock.

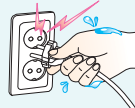

In case water gets in the power part, take power plug out and wait until the product dries completely.

It may cause an electric shock or a fire.

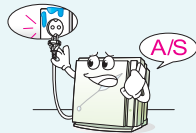

Do not pull out power cable, and do not put into and pull out power plug continuously.

It may cause an electric shock.

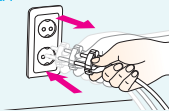

Do not bend power cable not let the cable be pressed by something heavy. And do not pull or twist power cable.

It may cause an electric shock or a fire.

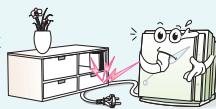

Clean anything like dust, water and etc on the power plug. And clean power part regularly.

※ do not clean it with volatile matter.
It may cause an electric shock or a fire.

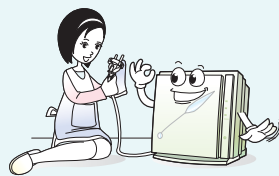

Warning

Installation safety

Install this product in a dry place.

It may cause an electric shock or a fire.



Keep away from heater, candle or cigarette butts.

It may cause a fire.

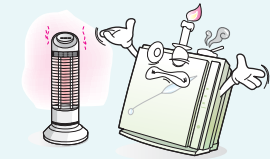

Notice

Do not use in a place like a restaurant in where a lot of oil is used or generated.

It may slow down the performance.



Do not place anything on the product.
It may cause a failure.



Keep this product out of the direct rays of the sun.

It may cause discoloration and decolorization.



Do not install on an inclined plane.
Do not give impact on the product.

It may cause a breakdown or a failure.



SAFETY INFORMATION

Please read this information to prevent property loss and ensure your safety.



Operation safety

※ Air can be dry if the product is used for a long time in an airtight place.



Danger

Do not put finger or debris in the air intake or blowhole.
Do not poke the product with something sharp.

It may cause an injury or a failure.



One may not hang or step on the product.

It may cause an injury.

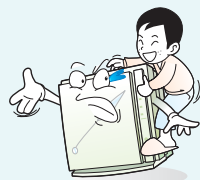

Warning

Do not sprinkle any inflammable material as like insecticide or air fresheners near the product.

It may cause a fire or slow down of the performance.

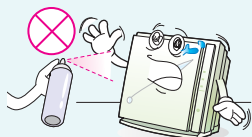

Be careful not to get your body or anything caught in the upper part of the product when open front cover.

It may cause an injury.

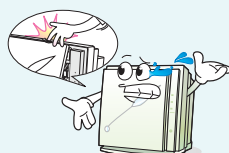

Notice

Wash pre-filter regularly with water and dry it thoroughly before use.



Medium filter, HEPA filter, Ag allergy shield filter, Deodorant filter are not recycled by water washing, so do not wash them nor put them into water.

Change the filter with new filter at the time of filter change.

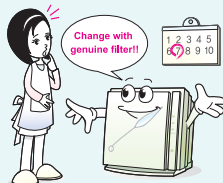

Be careful during installation for effective use of the product.

Keep the product away from wall and objects, need more space than 20cm right and left, 30cm ~ 60cm above.

Objects near wall and ceiling can be contaminated.

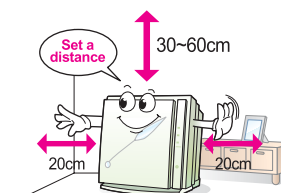

Keep the product away from lighting equipment and direct rays of the sun.

The product can not be controlled with remote controller.

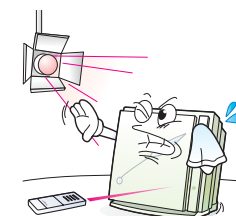

Install the product away more than 2m from electronic goods as like TV.

There can be electromagnetic interference.

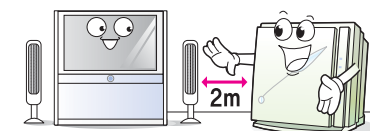

Be sure that anything does not block the product and air-circulation.



FEATURES

1 Outstanding air purity capacity

Used nano silver and catechin treated HEPA filter with powerful anti-biotic/anti-mold capacity to remove floating minute dust and bacteria in the air, and optimized filter system to remove pollutant quickly.

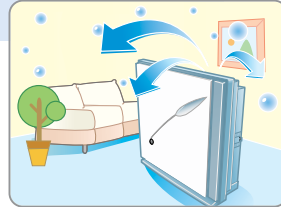

2 Highly improved deodorant capacity

Smell removal function is more improved using deodorant filter which can remove not only hazardous gas as like Volatile Organic Compounds (VOCs), formaldehyde but also food smell or cigarette smell.

※ hazardous gas remove test
VOCs fields (toluene, benzene, xylene, styrene), formaldehyde, ammonia, acetaldehyde, acetic acid (Other CO mentioned above is not removed.)



3 Anion generation

Generate healthy anion to make you feel refreshed even in indoor as if you were in the woods.

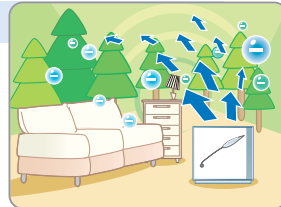

4 Turbo operation which can remove dust and smell in a short time

Applied turbo operation system to purify indoor space in a short time when dust and smell pollution is high.



5 Purity level lamp

Function to detect purity level of indoor air automatically and report to the user on the petal purity level lamp and it even has interior appearance.

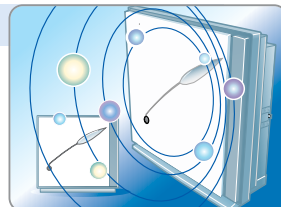

6 Infant mode

Run the product with a weak wind to prevent infant from feeling cold.

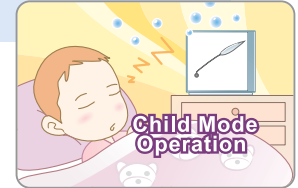

7 Rhythmical purity system

Applied rhythmical purity system suitable for indoor Air-Circulation so that indoor pollutant can be removed quickly.

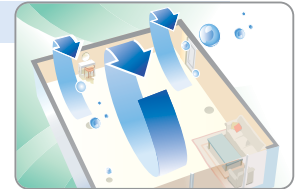

8 Silent operation at night

The product is planned to be changed to silent operation at night to make silent and comfortable surroundings during sleeping.

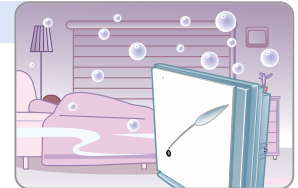

9 Wall-mounted type slim design

Applied slim design which goes well with wall.

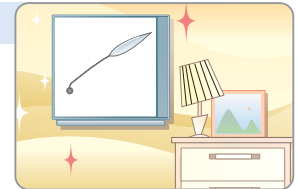

10 Customer centered safety planning

When the front cover is opened during running, all operation will be shut down automatically. And planned air intake and blowhole safely to prevent any risk of accidents previously.

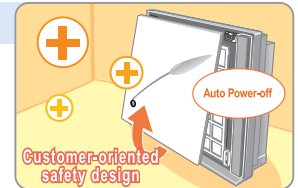

11 Remote controller

Applied remote controller for the convenient use of the product even in the case the product is far away or installed in wall-mounted type.





NAMES OF EACH PART

Front / Side

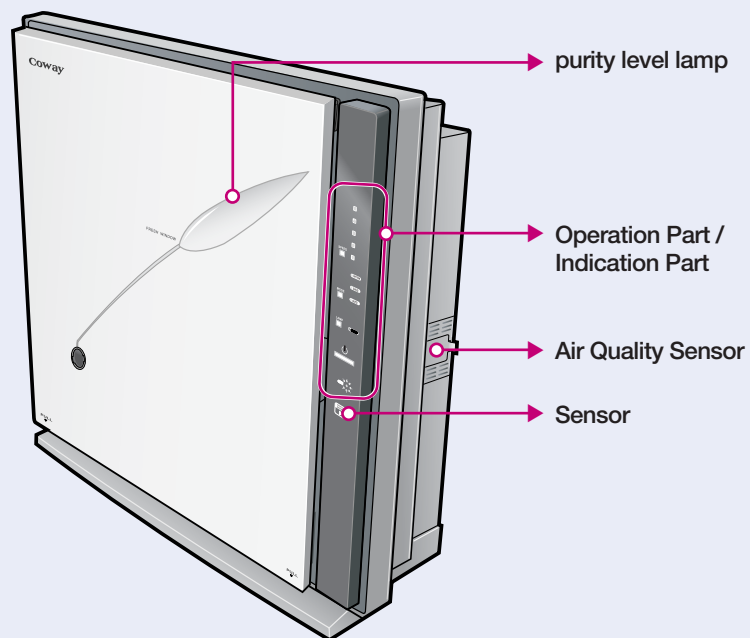

Lamp to display current indoor purity level

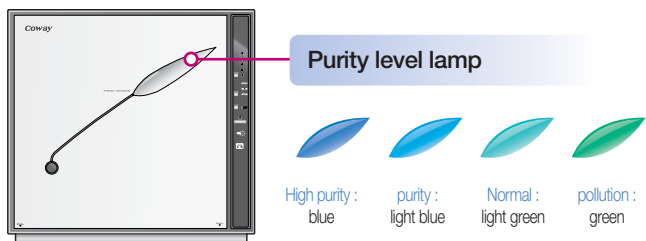

Rear

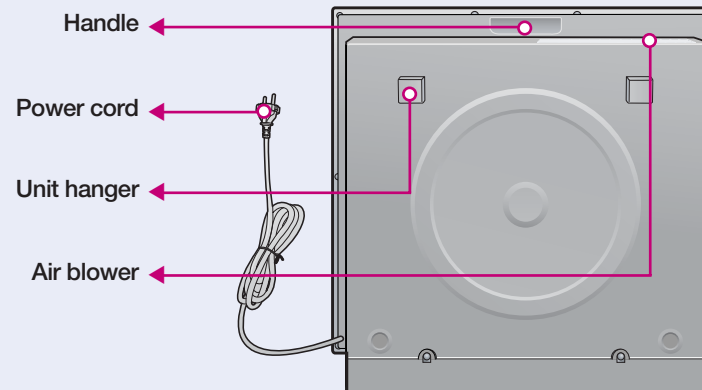

Remote Control

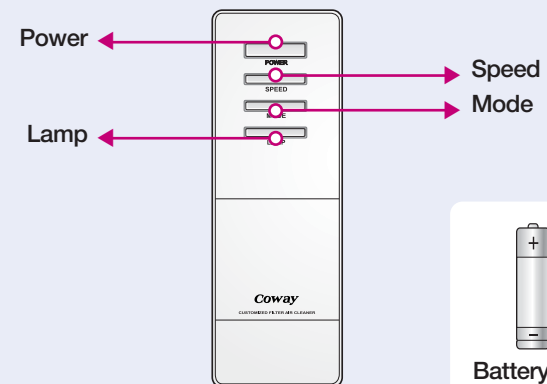



NAMES OF INTERNAL FILTERS

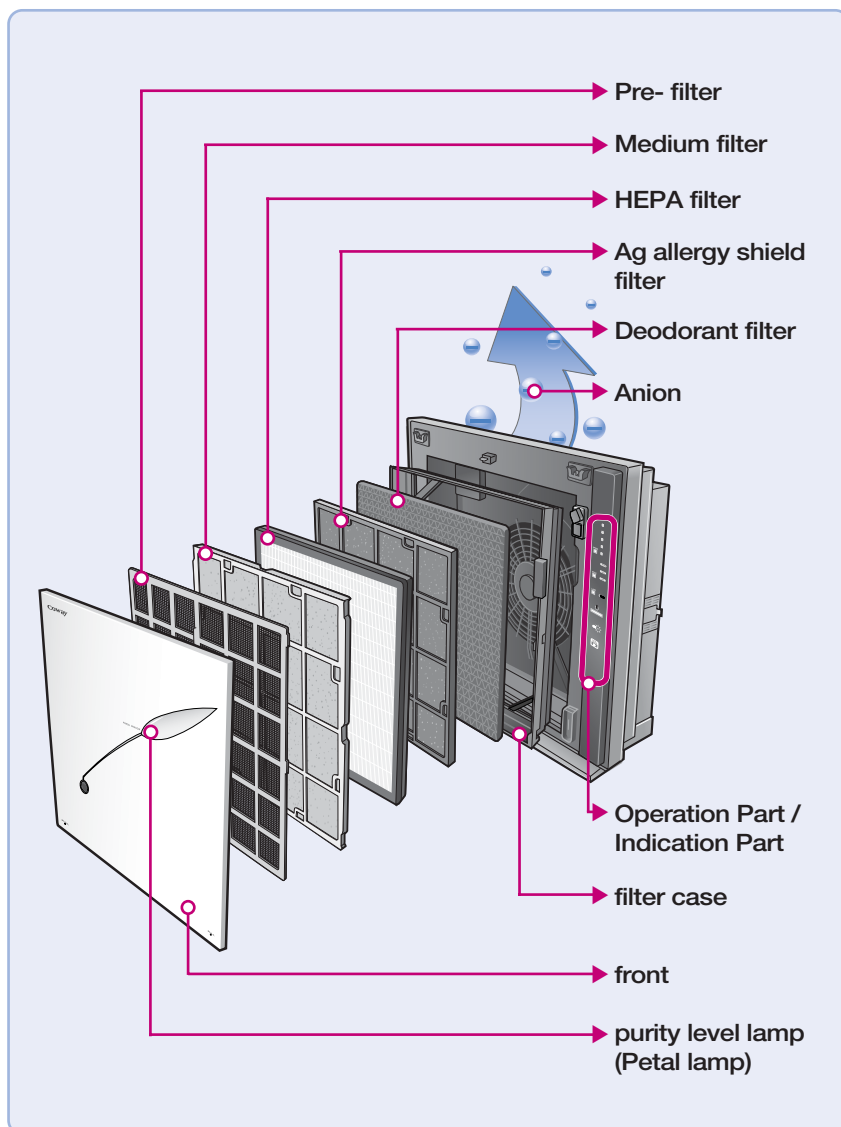

OPERATION/INDICATION PART

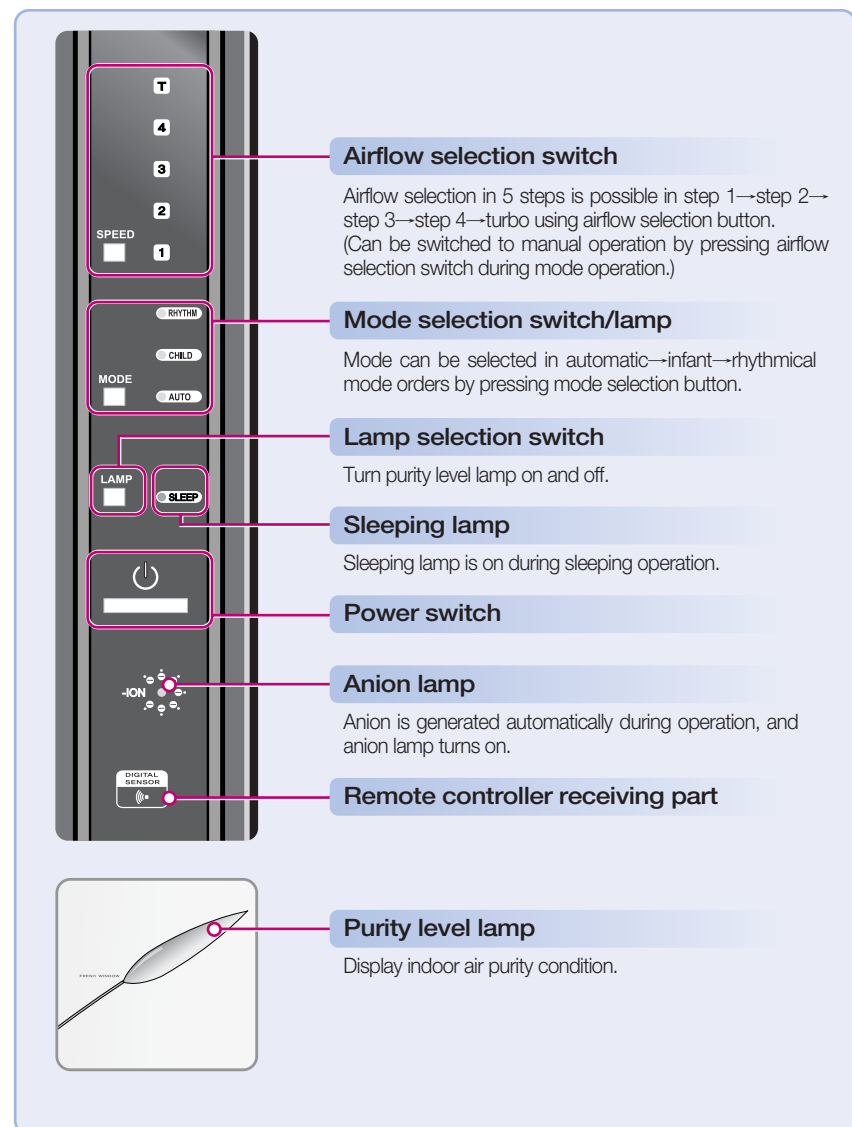



PREPARATIONS



- Please remove packing vinyl before installation.
- Make sure to use only in indoor and separate plug from outlet when the product is not used.
- Check front side of filter.

Filter installation

► Filter order : pre- filter→medium filter→HEPA filter→Ag allergy shield filter→Deodorant filter

- 1 Open front cover and take filter case out.

Pull the lower part of front cover, and lift it to open.
Pull side handle to take out filter case from the product.

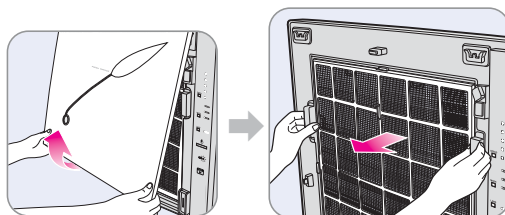

- 2 Place filter case on the floor, remove packing for each filter and put them in the case in reverse according to filter steps.

Check filters front side during filter installation.

In case of Ag allergy shield filter, place the filter in its own case with black side front and put it in the filter case.

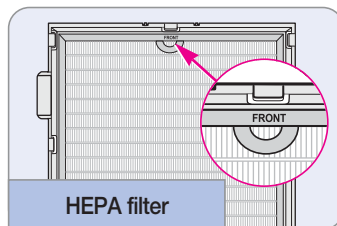
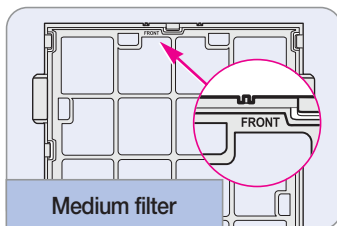
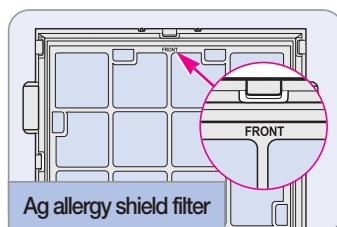
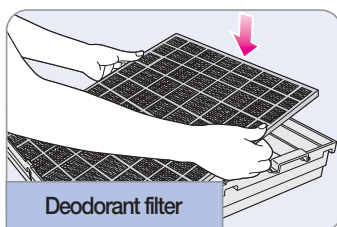

- 3 To install pre- filter, place pre- filter at the 6 hooks of filter case correctly with FRONT mark front.

Filter case hook

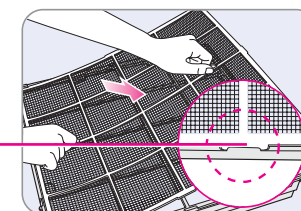

- 4 Place the lower part of filter case first and push the upper part of the case in. Install front cover into the product and close it.

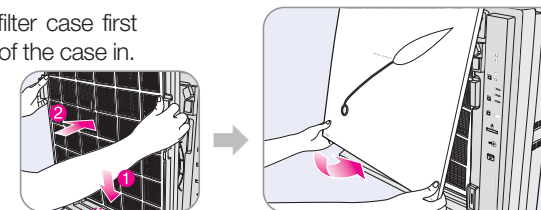

Remote controller preparations

- Open remote controller pushing down the rear part and pushing down the battery cover, and place AAA size battery setting positive and negative pole. Close the cover pushing up the cover.

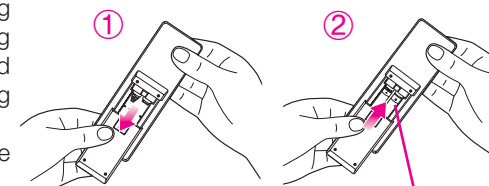

During using of remote controller

- If remote controller does not work, check if life-time of battery is over due.
- Use the same size of two AAA batteries to change them.
- Take the batteries out if the remote controller is not used for a long time.
- The life-time of batteries may be differing from the frequency of remote controller.

How to use remote controller

- use remote controller facing the receiving part of the product.
- The remote controller can not work if there is any obstacle between the controller and the product.
- Do not impact remote controller.
- Do not keep the controller in a wet place or direct rays of the sun, and near heat of fire.

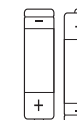



HOW TO USE



- put power plug into the outlet before operation.
- At the first use of the product, press power switch to operate the product in automatic mode.

Manual operation

- Turn power switch on, select airflow by pressing airflow selection switch.
step 1→step 2→step 3→step 4→turbo

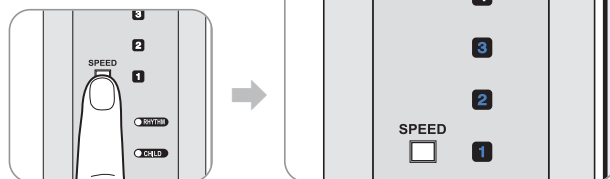

Mode selection

- Turn power switch on, select mode by pressing mode selection switch.
automatic→infant→rhythm

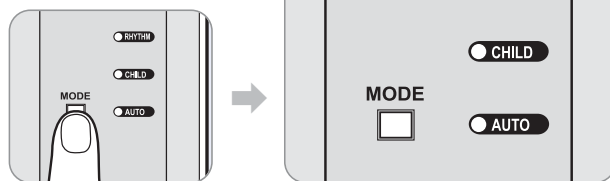

Automatic mode

Operate efficiently by adjusting airflow (step 1, step 2, step 3, and step 4) automatically according to the indoor pollution detected by sensor. It is convenient operation mode for general users.

Infant mode

Operate automatically according to the indoor pollution as just like automatic operation, airflow runs at a smaller amount than automatic operation to prevent an old and feeble person from feeling cold by the wind from the product.

Rhythmical mode

To remove dust efficiently even the dust at the corner of indoor, it operates at 4 steps changing airflows.
Step 1: step 1→step 2→step 3→step 4
Step 2: repetition of step 1
Step 3: step 1→step 3→step 2→step 4
Step 4: repetition of step 1 ~ 3

Sleeping operation (Just operated during automatic/infant mode operation)

- When it gets darks during automatic/infant mode operation, it runs automatically in low airflow, Noiseless, low power consumption. And it runs in general operation when it gets brighten again.

※ Sleeping lamp turns on in the light of 1/2 light of other lamp.

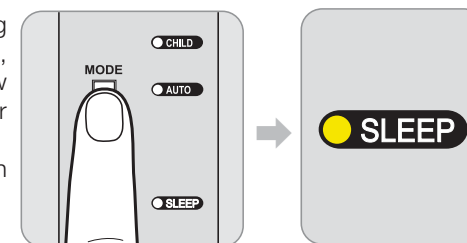

Purity level lamp ON/OFF

- Purity level lamp ON/OFF during general operation

You can turn purity level lamp on and off using lamp selection button.

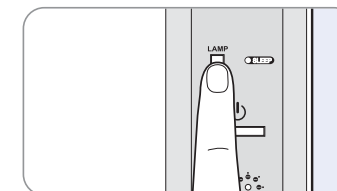

- purity level display lamp ON/OFF during sleeping operation

- ▶ Purity level lamp turns off when lamp selection button is pressed.



Press lamp selection button.

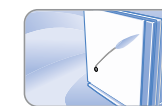

Purity level lamp turns off.

- ▶ When you turn lamp selection button again, purity level lamp turns on in the light of 1/2 of general operation light.



Press lamp selection button.

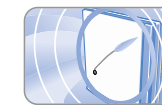

Purity level lamp turns on in the light of 1/2 of general operation light.

※ Purity level lamp ON/OFF is possible during power is shut off.

HOW TO USE

Air quality sensor

The product is initially set in standard sensitivity. You can adjust sensor sensitivity as like the following methods when humidity is high, when purity level lamp operates more than 2 hours even not in the case of severe yellow sand and when purity level lamp keeps green more than 1 hour in the case of high indoor pollution.

- 1 On the condition of operation, press airflow selection / mode selection button more than 2 seconds at the same time.

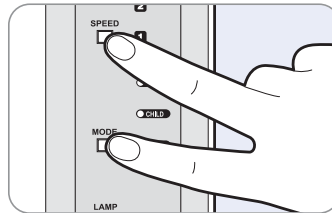

- 2 Purity level display lamp on the front side twinkles in yellowish green color.

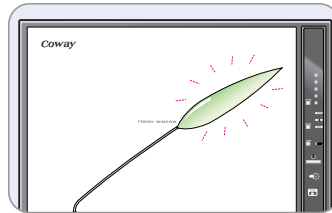

- 3 Adjust to desired sensor sensitivity by pressing airflow selection button. Sensor sensitivity displayed by twinkling mode display lamp.

Insensibility	Standard	Sensibility
Rhythm	Infant	Automatic

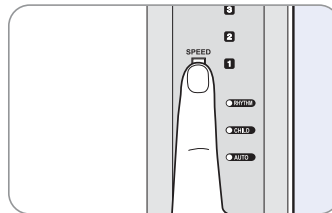

- 4 If press airflow selection/modes election button again more than at the same time, the product starts working normally and sensor sensitivity input.

If there is no button input for 10 seconds, the value input automatically.

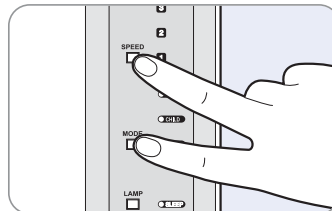

CLEANING METHOD



- ! – Make sure to take power plug out prior to filter cleaning.
- Do not use volatile matter or detergent, etc.
- Do not put the product in water or spray water.

Cleaning the air quality sensor (Every 2 Months)

- 1 Clean the air inlet and outlet using a vacuum cleaner or soft brush.
- 2 Open the particle sensor cover on the right side of the unit (when facing the unit). Use a wet cotton swab to clean and dry the lens, dust inlet and dust outlet.

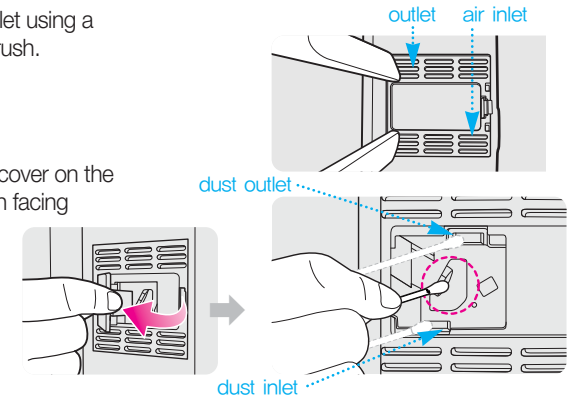

Cleaning the air intake and outlet

- 1 Clean the air intake and outlet with a soft brush. Be careful not to drop the brush into the unit.

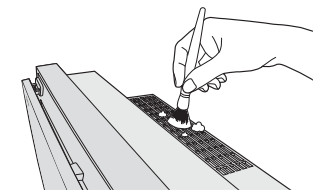

Cleaning the negative ion generator (Every 2 Months)

- 1 Use a dry cotton swab to remove dust on the plate. Be careful not to drop the cotton swab into the unit.

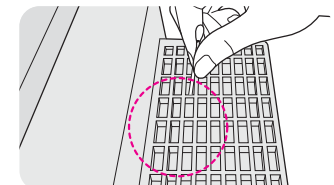

CLEANING METHOD

Cleaning the front cover

- Remove the front cover from the unit and use a dry cloth or soft brush to dust it off. Use a wet cloth if necessary but do not use a polisher.

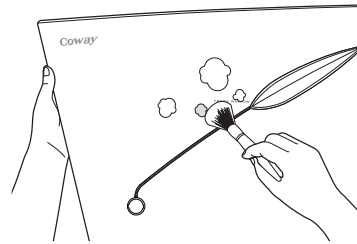

Cleaning the lens on the back of the front cover (Every 2 Months)

- Remove the front cover from the unit and use a dry cloth, soft brush, or cotton swab to dust off the mood light on the back of the cover. Use a wet cloth if necessary but do not use a polisher.

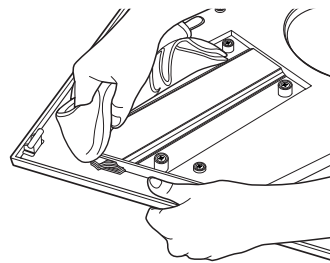

Cleaning the unit

- Use a dry and soft cloth to clean the unit. Use a wet cloth if necessary but do not use a polisher.

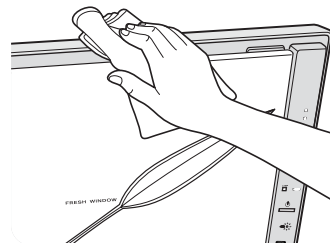

FILTER CLEANING METHOD



- Make sure to take power plug out prior to filter cleaning.
- Pre- filter can be recycled by dust removal or water washing.
- If pre-filter cleaning is not done for a long time, it may cause slow down of performance of the product.
- **Medium filter, HEPA filter, Ag allergy shield filter, Deodorant filter can not be recycled by washing. Washing can damage filters.**

Pre- filter cleaning (Every 2~4 Weeks)

- 1 Lift to separate body pulling the lower part of front cover.

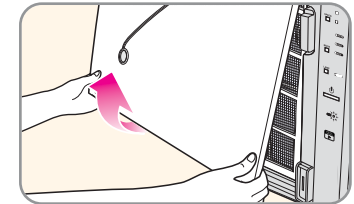

- 2 Pull pre- filter handle to take it out.

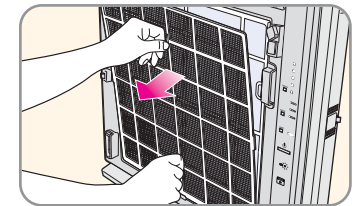

- 3 Remove dust with vacuum cleaner or water according to pollution level.

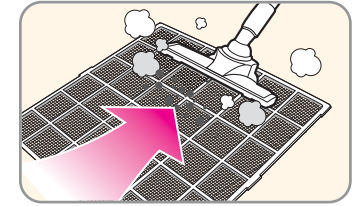

- 4 Dry well pre- filter to before installing in the filter case, and push to the end of the product. Install front cover in the product again.

Fix Pre-filter in the filter case hook correctly to install in the filter case.

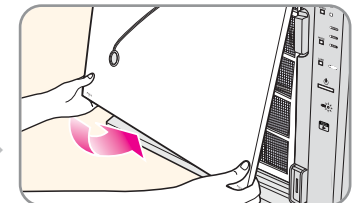
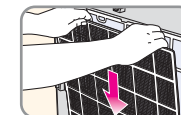



FILTER REPLACEMENT

 Make sure to pull power plug out prior to filter change.

Change method

- ▶ change filters referring to filter preparation section in page 13.
- ▶ Check front side of HEPA filter, Ag allergy shield filter to change filters.
- ▶ Just use Coway's genuine product filters.



Replacing the medium filter (Every 4 Months)

1 Open front cover and separate filter case from the product and take medium filter out of filter case.

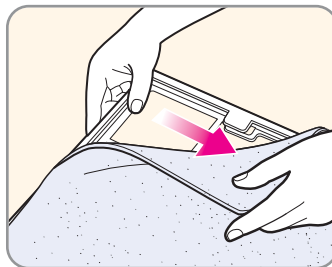
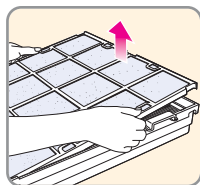

2 Remove vinyl packing of the new filter and put it into medium filter case. Assemble filter case to the product in reverse and close front cover.

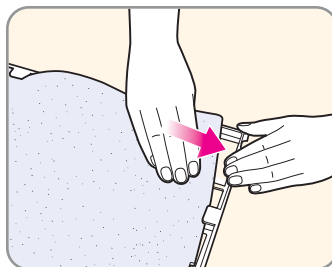
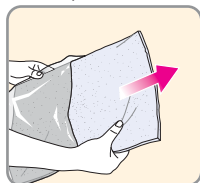

Replacing the HEPA filter (Every 12 Months)

1 Open front cover, separate filter case out of the product and take HEPA filter out of filter case.

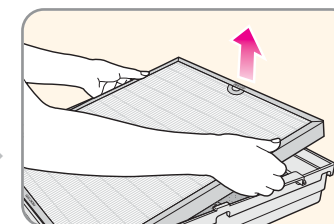
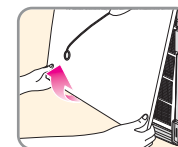

2 separate vinyl packing of new filter and put HEPA filter in the filter case. Assemble filter case in the product and close, front cover.

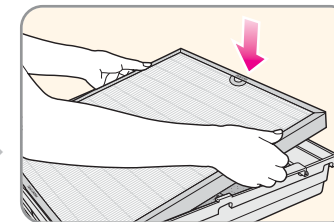
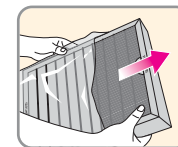

Replacing the ag allergy shield filter (Every 6 Months)

1 Open front cover, separate filter case out of the product and take Ag allergy shield filter out of Ag allergy shield filter case.

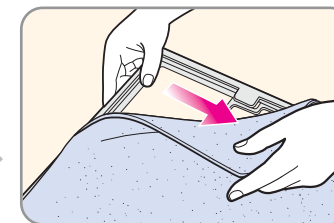
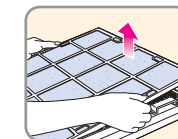

2 Remove vinyl packing of new filter, put into Ag allergy shield filter case so that black non-woven fabric of Ag allergy shield comes to front side. Assemble filter case into the filter case in reverse and close front cover.

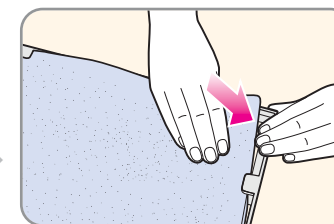
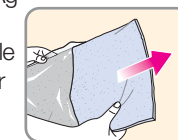



FILTER REPLACEMENT

! Make sure to pull power plug out prior to filter cleaning.

Replacing the Deodorant filter (Every 12 Months)

1 Open front cover, separate filter case out of the product and take Deodorant filter out of filter case.

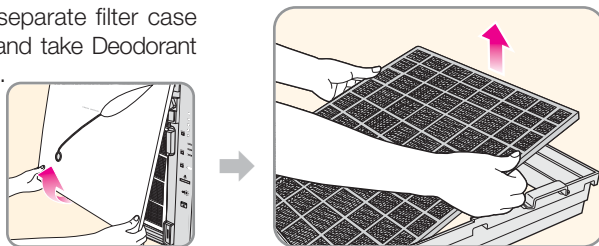

2 Remove vinyl packing of new filter, Put Deodorant filter into the filter case. Assemble filter case into the product in reverse of separation, and close front cover.

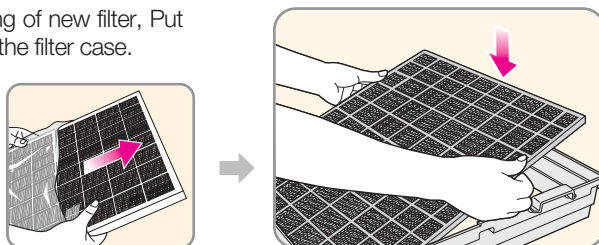

Filter Orders Pre- ⇒ medium ⇒ HEPA ⇒ Ag allergy shield ⇒ Deodorant

Cleaning and replacement schedule

Filters	Replacement	Cleaning
Pre-	Every 2~4 Weeks	Cleaning
Medium	Every 4 Months	Replacement
HEPA	Every 12 Months	Replacement
Ag Allergy Shield	Every 6 Months	Replacement
Deodorant	Every 12 Months	Replacement

* based on 24 hours/1 day automatic operation.

INSTALLATION METHOD

! Contact A/S center to install the product on the wall.

Installation on the wall method

Fitting method

Install using wall-mounted panel saving some distance from wall and ceiling right and left as shown in the picture.

- When the product is used on the wall, it may contaminate wall or ceiling.
- Be careful not to drop front cover and filter case down during maintenance or filter change.
- Do not pull power cord.

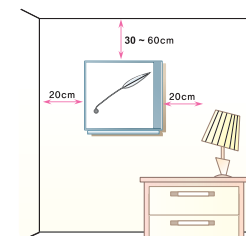

! Make sure the product is installed strongly on the screw of wall-mounted panel.

wall-mounting parts

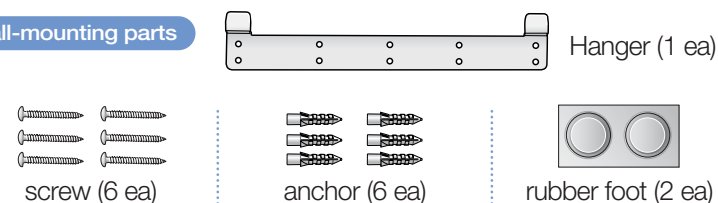

1 Determine the place on which the product is going to be installed.

Make a hole to install hanger using a nail and put an anchor in. Place hanger on it and fix it on the wall using screw.

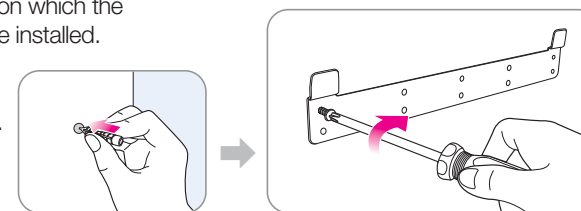

2 Place rubber foot on the 2 ea of round projection on the lower part of the back side of the product.

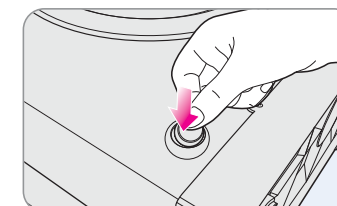

INSTALLATION METHOD

Installation on the wall method

- 3 Separate base by pulling out screw on the lower part of the back side.

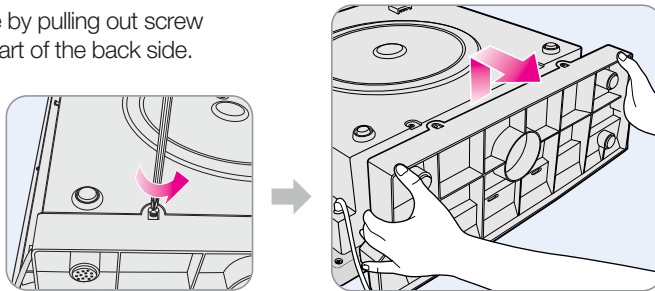

- 4 Install the product in the hanger. Make sure that hanger fits in the hanger rack on the back side of the product completely.

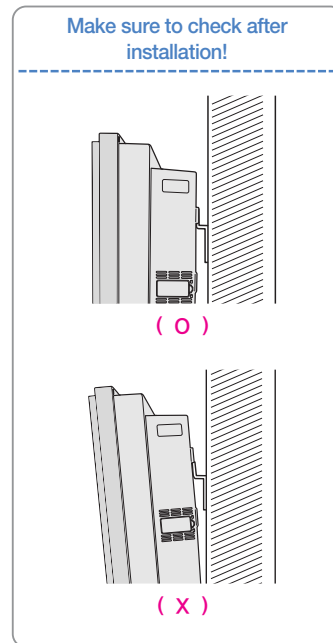
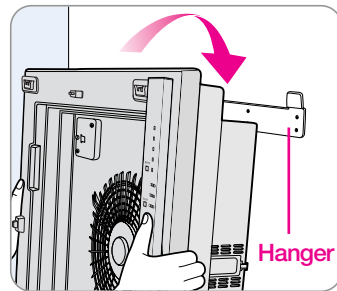

- 5 Check installation and install filter and front cover on the product.



BEFORE ASKING A/S

Please check the followings before request for A/S.

Please check out the following information before contacting Customer Service. The unit might not operate properly due to a lack of knowledge about the unit. If the problem still remains despite referring to this guide, then please call the customer service center.

Symptom	Check	Remedy
No wind blows out.	<ul style="list-style-type: none"> Is power plug connected? Is display parts are all off? Check if it is not a power failure. 	<p>Voltage rating that matches it on the rating plate.</p> <p>Press operation/stop button and select desired function.</p> <p>Use the product after power is on.</p>
No wind change in automatic/ infant / rhythmical operation.	<ul style="list-style-type: none"> Is in manual operation? Is the room dark? 	<p>Set the product at the desired operation mode.</p> <p>Wind fixed to the latest during night silent operation.</p>
Color of purity level lamp is always same.	<ul style="list-style-type: none"> Is there dust on the nearby sensor lens? Is dust purity level keeps showing high? Is dust purity level keeps showing high? 	<p>Clean dust nearby sensor lens. Page 18</p> <p>Adjust dust sensor to insensitivity or standard. Page 17</p> <p>Adjust dust sensor to sensibility or standard. Page 17</p>
Wind volume is very weak. It smells from ventilator.	<ul style="list-style-type: none"> Is filter cleaning and change time overdue? 	<p>Install correctly. Check to clean or change the filters. Page 20-23</p>
Remote controller does not work.	<ul style="list-style-type: none"> Check the batteries. Check if the batteries are fitted in correctly (positive, negative)? Does the room light twinkles? Is there any electronic goods near the product? 	<p>Changer the batteries. Page 14</p> <p>Check positive and negative pole of the batteries. Page 14</p> <p>Change fluorescent light or move the product.</p> <p>Keep the product away from electronic goods more than 2 m.</p>

BEFORE ASKING A/S

Symptom	Check	Remedy
Smells from blowhole.	<ul style="list-style-type: none"> Is filter cleaning and change time overdue? 	Check filter cleaning and change time and filter to clean or change filters.
Purity display part twinkles.	<ul style="list-style-type: none"> Request for A/S and ask for it. 	
Other functional matter happens	<ul style="list-style-type: none"> Check the conditions of the problem and take power plug out to request for A/S and ask for it. 	



Warranty Information & Specifications



Please fill in the blanks and save this in order to request service.

Customer Information						
Product Name	Air Purifier			Warranty Period		
Model	AP-1005AH			1 year		
SER. No.						
Purchase Date	Day	Month	Year			
Warranty Period	Day	Month	Year	Unit	Month	Year
Address						
Customer's Name	TEL.			MOBILE.		
Specifications						
Power Supply	Voltage rating that matches it on the rating plate.					
Power consumption	47W					
Dust Collection Method	HEPA Filter Type					
Safety Method	Automatic power-off					
Room Size	300ft ²					
Maximum Volume of Air	5.8m ³ /min					
Size	(W)544x(D)181x(H)510mm					
Weight	8.8 kg					

* Without prior notice the unit could be changed to improve its performance.

Free Manuals Download Website

<http://myh66.com>

<http://usermanuals.us>

<http://www.somanuals.com>

<http://www.4manuals.cc>

<http://www.manual-lib.com>

<http://www.404manual.com>

<http://www.luxmanual.com>

<http://aubethermostatmanual.com>

Golf course search by state

<http://golfingnear.com>

Email search by domain

<http://emailbydomain.com>

Auto manuals search

<http://auto.somanuals.com>

TV manuals search

<http://tv.somanuals.com>