

			
	<b>PHS300</b>	<b>CBA250</b>	<b>MBR1200</b>
<b>USES</b>	Travel Battery Powered	Special App. Redundant ISP Backup Digital Signage	When VPM is needed Small Business Failover Load Balance
WAN via USB PORT	•	•	•
WAN via EXPRESSCARD		•	•
WIFI (802.11 B/G)	•		•
WIFI (802.11 N)			•
WEP, WPA, WPA- ENTERPRISE	•		•
WIFI ANTENNA EXTERNAL PORT(S)			•
FAILOVER			•
FAILBACK			•
LOAD BALANCING			•
BATTERY POWERED	•		
SNMP MANAGEMENT (V1)			•
3G SUPPORT	•	•	•
4G/WIMAX SUPPORT	•	•	•
IP PASS-THROUGH		•	
IPSEC VPN			•
List price (Ext GST)	<b>\$240</b>	<b>\$260</b>	<b>\$440</b>

[www.cradlepoint.com](http://www.cradlepoint.com)

Distributed in Australia and New Zealand by Unique Micro Design (UMD)

[www.umd.com.au](http://www.umd.com.au)



**PHS300**

# 3G/4G Personal WiFi Hotspot

Create WiFi from Broadband USB Modem or Tethered Phone

**EASY TO USE**

The CradlePoint PHS300 Personal WiFi Hotspot is a true plug-in-play solution that creates a powerful WiFi network almost anywhere\*. Simply connect up to 16 WiFi enabled devices by plugging in your USB mobile broadband data modem and turning on the PHS300. It's that easy to create you own hotspot wherever you are - no more searching or paying for WiFi when you're out and about.

**COMPACT AND PORTABLE**

Our most portable wireless router, the CradlePoint PHS300 comes standard with a fully rechargeable Li-Ion battery providing hours of access even when no power outlets are in sight. The PHS300 provides full WiFi functionality when recharging. At just under 3" x 5", the PHS300 is a perfection solution for those on the go. Take the PHS300 everywhere you need secure, reliable WiFi access.

**SECURE AND RELIABLE**

Powered by WiPipe™ technology, PHS300 requires minimal setup and maintenance, including pre-installed software for right-out-of-the-box simplicity. Standard in the PHS300 are security features like multiple WiFi-encryption modes like WEP and WPA/WPA2 (Personal & Enterprise) and built-in firewall, which prevent unauthorized use of your connection. With no additional software to load, you'll be up and running in minutes.

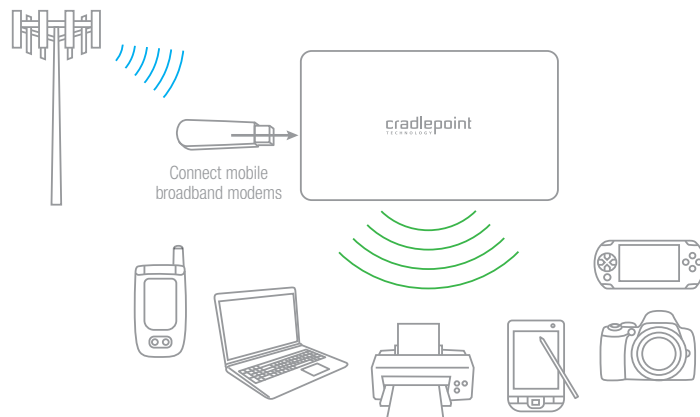

PHS300  
FEATURES

- **Create A Secure WiFi Network Instantly**
- **Rechargeable / Removable Li-Ion Battery**
- **Portable, Shareable with up to 16 Devices**
- **No Software or Drivers To Install**
- **Plug 'n' Play - Zero Hassle**
- **Battery Powered Hotspot To Go**

Connects with any WiFi-enabled device:



PHS300

# 3G/4G Personal WiFi Hotspot



## SPECIFICATIONS

MODEL NAME:	PHS300 Personal WiFi Hotspot
WiFi Standards:	IEEE 802.11 b/g
NETWORK CONNECTIONS AND PORTS:	One (1) USB Modem
BUTTONS/SWITCHES:	Power On/Off Switch, Reset (in battery compartment)
LED INDICATORS:	Power, WLAN (Mobile Broadband), Network Connection
POWER:	Rechargeable Li-Ion Battery, 5V DC, 2.5-3.0A; 100-240V AC
DIMENSIONS:	4.8-in x 2.9-in x 0.75-in (122mm x 73mm x 18.5mm)
WEIGHT:	3.5 oz. (128g)
TEMPERATURE:	0°C to 50°C (32°F to 120°F) Operating -20°C to 70°C (-4°F to 158°F) Storage
RELATIVE HUMIDITY:	10% - 85% Operating / 5% - 90% Storage
CERTIFICATIONS:	FCC, CE, IC, WiFi Alliance

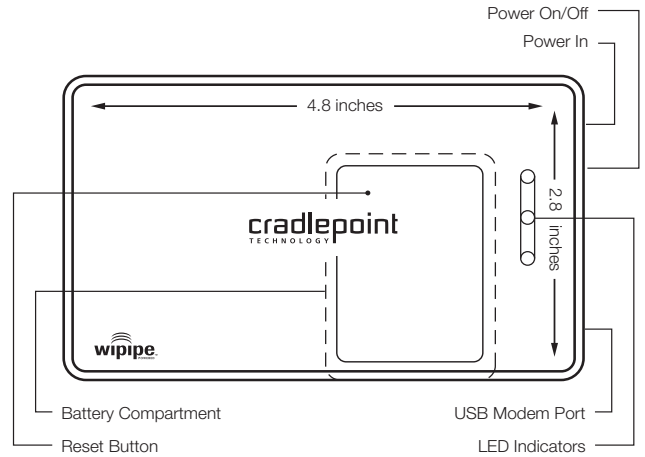

## RECOMMENDED ACCESSORIES



## DETAILS

Use with USB-Style Cellular Modem, or Phone with Data Tethering Capability
Compatible with HSPA and EVDO Cellular Network Devices
Universal Plug-n-Play and ALGs support for Internet Applications: Email, FTP, Gaming, Remote Desktop, NetMeeting, Telnet, SSH, And SCP
Flash Memory for Firmware Upgrade, Save/Restore Settings
Easy Management via HTTP
Networking Compliance with IEEE 802.11 b/g Standards
Compliant with Windows 98SE/NT/200/XP/Server 2003/Linux/Mac OS

## SECURITY

Access control available in encrypted and open modes, password-protected access to prevent unauthorized usage.
Provides additional security of Enable/Disable Network Name Broadcast and Internet Access Control (Services, URL, and MAC Filtering)
Firewall features Network Address Translation (NAT) and Stateful Packet Inspection (SPI) which protects against DoS Attacks
Multiple Concurrent IPSec, L2TP and PPTP VPN Pass-Through Sessions

## MINIMUM REQUIREMENTS

Mobile Broadband Data Card with Active Subscription (USB or ExpressCard), or Supported Phone with Active Tethered Data Plan Suggested\*

Management Interface Requires an Internet Browser: Internet Explorer v6.0, Firefox v2.0, or Safari v1.0 Minimum

## IN THE BOX

- PHS300 3G/4G Personal WiFi Hotspot
- Li-Ion Rechargeable Battery
- Quick Start Guide
- AC Power Adapter

\* Requires Activated USB and/or ExpressCard Modem with a Mobile Broadband Carrier. Over 100 Modems and Handsets are Supported.  
 \*\* Based on Mobile Broadband Coverage

## **CBA250** **3G/4G Mobile Broadband Adapter**

*Ethernet to Mobile Broadband, Mobile Broadband to Ethernet*

### **SIMPLE SOLUTION**

The CradlePoint CBA250 3G/4G Mobile Broadband Adapter provides IP Pass-Through capabilities for a LAN device requiring wireless broadband access.\* For most applications, simply connect the CBA250, turn the unit on, and it's ready to go. Quickly installs, the CBA250 handles the connection without configuration and provides enhanced network connectivity with support for USB and ExpressCard\*\* modems running on 3G/4G Networks. Adding a wireless backup or even primary connection has never been easier.

Quickly Add Mobile  
Broadband To Any  
Ethernet Connection

### **POWERFUL, RELIABLE, CONVENIENT**

As a high-performance adapter, the CBA250 supports multiple and concurrent application streams for the attached LAN device converting Ethernet to mobile broadband and mobile broadband to Ethernet. This flexible connectivity solution is platform independent, features two operating modes (configuration and IP Pass-Through), and has an "always-on" signal strength meter to determine the best mobile broadband reception for optimum placement. The CBA250 is truly a "drop-in" 3G/4G solution for adding mobile broadband capability effortlessly.

#### **Primary Connection Using the CBA250**

*Using 3G/4G Instead of Wired Connections Provides Greater Flexibility*

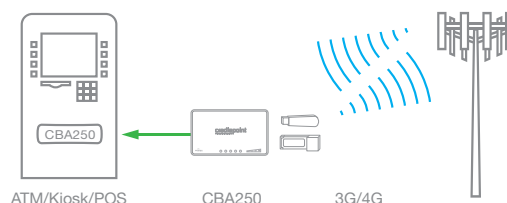

#### **CBA250 Failover to 3G/4G**

*When Primary ISP Fails, the CBA250 Automatically Provides Service Without Interruption*

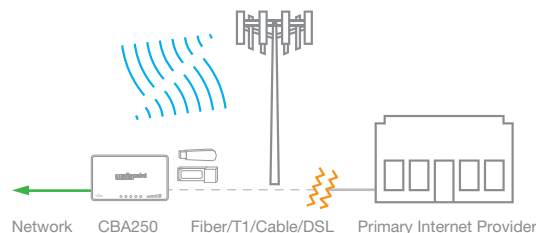

#### **CBA250 FEATURES**

- **3G/4G Modem Support**
- **A "Drop-In" Wireless Broadband Solution**
- **Installs in Minutes - No Software to Load**
- **Great for Failover Redundancy or Primary Connect Applications**

**CBA250**

# 3G/4G Mobile Broadband Adapter



## SPECIFICATIONS

MODEL NAME:	CBA250 Mobile Broadband Adapter
ETHERNET PORTS:	One (1) Ethernet
MOBILE BROADBAND PORTS:	One (1) USB, One (1) ExpressCard
BUTTONS/SWITCHES:	Signal Strength Display, Reset, Configuration Mode/ IP Pass-Through Mode
LED INDICATORS:	Power, Ethernet LAN Activity, USB Modem Activity, ExpressCard Modem Activity, Signal Strength Indicator
POWER:	5V DC, 2.5-3.0A; 100-240V AC
DIMENSIONS:	4.8-in x 2.8-in x 0.8in (122mm x 73mm x 18.5mm)
WEIGHT:	3.5 oz. (128g)
ENVIRONMENTAL TEMPERATURE:	0°C to 50°C (32°F to 120°F) Operating -20°C to 70°C (-4°F to 158°F) Storage
RELATIVE HUMIDITY:	10% - 85% Operating / 5% - 90% Storage
CERTIFICATIONS:	FCC, CE

## DETAILS

Drop-In, Easy To Use Adapter - No Software To Install
Compatible with 100+ EVDO, HSPA, and WiMAX Cellular Network Devices
10/100 BASE-T Ethernet Port
IEEE 802.3u Compliant - Supports Cable/DSL Modems with Dynamic IP, Static IP, PPPoE, PPTP, and L2TP Connection Types
Universal Plug-n-Play and Application-Level Gateway for Internet Applications: Email, FTP, Gaming, Remote Desktop, NetMeeting, Telnet, SSH, and SCP
Flash Memory for Firmware Upgrades and Save/Restore Settings
Easy Local or Remote Management via HTTP, HTTPS, and SNMP

## MINIMUM REQUIREMENTS

Mobile Broadband Data Modem with Active Subscription (USB or ExpressCard) **
Management Interface Requires An Internet Browser: Internet Explorer v6.0, Firefox v2.0, or Safari v1.0 Minimum

## IN THE BOX

- CBA250 3G/4G Mobile Broadband Adapter
- Quick Start Guide
- AC Power Adapter

## PRODUCT DIAGRAM

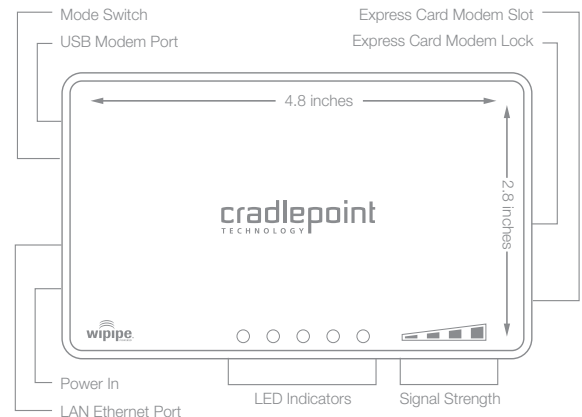

## RECOMMENDED ACCESSORIES



**Additional Power Supply**



Secure, Manage & Maintain The Edge of 3G/4G Network



\* Based on Mobile Broadband Coverage

\*\* Requires Activated USB and/or ExpressCard Modem with a Mobile Broadband Carrier. Over 100 Modems are Supported.

**MBR1200**

# Failsafe Gigabit N Router for Mobile Broadband

with **VPN Support**

**ALWAYS CONNECTED**

The CradlePoint MBR1200 is a robust 802.11n router with 3G/4G \* failover capabilities. Built for home, small business, branch offices, temporary and remote enterprise environments seeking to implement continuous, always-on connectivity.

With its failover/failback capability, the MBR1200 automatically switches to a secondary connection (either wired or wireless) when your primary service is interrupted. Once your service is restored, the MBR1200 will automatically failback to the primary connection - keeping your business online with minimal interruption to users.\*\*

**VPN: SECURE AND RELIABLE**

The high-performance MBR1200 has the capability to create, manage, and terminate multiple IPsec VPN sessions. It provides up to five concurrent sessions, supporting transfer and tunnel modes and several Hash and Cipher algorithms. These encryption protocols protect your communications from one private network to another from end-to-end.

**ENTERPRISE POWER - SMB SIMPLE**

Powered by WiPipe™ technology, the MBR1200 router includes many features found in expensive, enterprise-class routers at a fraction of the cost. With minimal setup and maintenance, including our pre-installed software, it has “right out of the box” simplicity.

Standard on the MBR1200 are security features such as multiple WiFi encryption modes (WEP and WPA/WPA2 Personal and Enterprise) and built-in firewall, which prevent unauthorized use of your connection. With no additional software to load, you’ll be up and running in minutes.



MBR1200 features

- **Easy Setup & Maintenance**
- **High Performance Internal Antennas**
- **Cellular Redundancy Failover to 3G/4G**
- **Gigabit Ethernet Ports**
- **Works with USB, PC Card, & ExpressCard modems**
- **Modem Security Enclosure Available**

Whether you're wired or wireless, the MBR1200 Business Series Router keeps your business connected.

Connects With Any WiFi-Enabled or Ethernet Device



MBR1200

# Failsafe Gigabit N Router for Mobile Broadband



<b>SPECIFICATIONS</b>	MODEL NAME: MBR1200 Failsafe Gigabit Broadband N Router
	WAN / INTERNET: 3G/4G via Five Modem Ports (3 USB 2.0, 1 ExpressCard, 1 PC Card); One Ethernet Port (10/100/1000); One LAN Ethernet Port re-configurable to WAN for redundancy
	LAN: WiFi 802.11 b/g/n, Four Ethernet Ports (10/100/1000)
	ANTENNAS: internal WiFi antennas (300+ yards range), external antenna ports for optional antennas providing additional distance and performance.
	BUTTONS / SWITCHES: WiFi On/Off Switch, WPS Button (WiFi Protected Setup), Modem Signal Strength, Reset, and Power Switch
	LED INDICATORS: Power, Ethernet LAN (1-4), Ethernet WAN, 3G/4G WAN, 3G/4G Modem Status (5), WPS (WiFi Protected Setup), Signal Strength
	DIMENSIONS: 9" x 5.1" x 1.57" (230mm x 130mm x 40mm)
	OPERATING TEMPERATURE: 0°C to 50°C

<b>IN THE BOX</b>	MBR1200 Failsafe Gigabit Broadband N Router, Power Adapter (12V, 1.5A), CAT5 Ethernet Cable (5ft), Mounting Hardware, Quick Start Guide, Accessory Guide
-------------------	--

<b>MINIMUM REQUIREMENTS</b>	Mobile Broadband USB, ExpressCard or PC Card Data Modem with Active Subscription or Supported Phone with Active Tethered (Phone-As-Modem) Data Plan
	Management Interface Requires An Internet Browser: Internet Explorer v6.0, Firefox v2.0, or Safari v1.0 Minimum

<b>DETAILS</b>	2.412 to 2.484 GHz Frequency Band Operation
	Compliant with IEEE 802.3 and 3u Standards
	Supports OFDM and CCK Modulation
	Supports Cable/DSL modems with Dynamic IP, Static IP, PPPoE, PPTP, or L2TP Connection Types
	Traffic Control and Virtual Server (max 32 servers) and DMZ
	Compatible with HSPA, EVDO, & WiMAX Cellular Network Devices
	Easy Management via HTTP and Remote Management via HTTP and SNMP
	Full Integration with WiPipe™ Manager (Optional Managed Services from CradlePoint)

<b>VPN INFORMATION</b>	Create, Manage, and Terminate Up To 5 IPsec VPN Sessions
	Supported VPN Implementations: MBR1x00 to MBR1x00, MBR1x00 to Cisco/Linksys Routers <sup>1</sup> , MBR1x00 to Linux Systems <sup>2</sup>
	Tunnel (default) and Transfer (a.k.a. Transport) Modes
	Hash Algorithms (hardware accelerated) - MD5, SHA128, SHA256, SHA384, SHA512
	Cipher Algorithms (hardware accelerated) - AES, 3DES, DES
	Keying - automatic using IKE 1.0 or Manual
	Authentication Method: Pre-Shared Key <sup>3</sup>
	<small>1 Tested against a Cisco 5500 running IKE Microcode: CNiite-MC-IPSEC-Admin-3.03 IPsec Microcode: CNiite-MC-IPSECn-MAN-2.03 2 Tested with Linux Kernel: 2.6.18 - 2.6.25; IKE (Racoon): 0.7.0 and 0.7.1 3 No Stream Compression, L2TP or PPTP Support</small>

<b>SECURITY</b>	Optional Modem Security Cap ensures your modems stay where you put them.
	Firewall features Network Address Translation (NAT) and Stateful Packet Inspection (SPI) which prevents against DoS attacks.
	Access Control available in encrypted and open modes, as well as password protected Internet Access to prevent unauthorized usage.
	Provides additional security of Enable/Disable SSID and Internet Access Control (Services, URL, and MAC Filtering)
	Supports multiple concurrent IPsec, L2TP, and PPTP VPN Pass-Through Sessions
	Supports 64/128-bit WEP, WPA, WPA2 (Personal & Enterprise) Wireless Security Modes

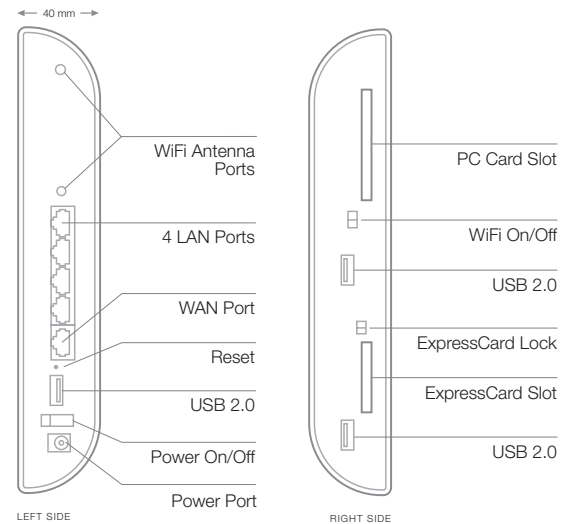
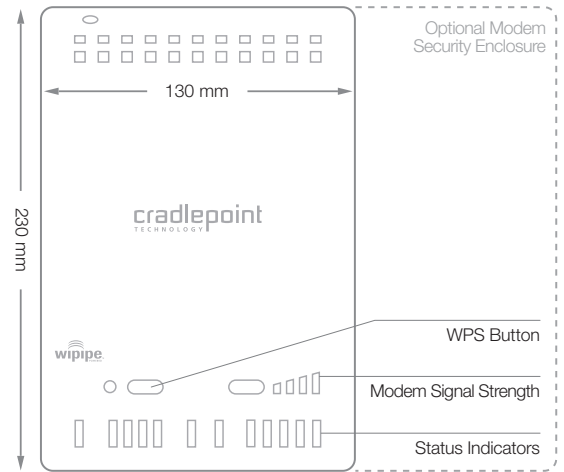

## RECOMMENDED ACCESSORIES

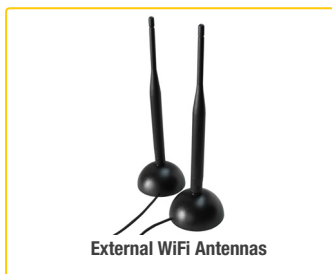

**Modem Security Enclosure**  
Protect your USB, ExpressCard, and PC Card modems with a security enclosure

**Car Power Adapter**  
Take your router on the road with ease

**External WiFi Antennas**  
Significantly extend the range of the MBR1200 with powerful antennas (wall mount kit included)





The CradlePoint PHS300 instantly creates a Wi-Fi hotspot that any Wi-Fi enabled device can connect to—laptop, camera, PDA, etc. The PHS300 then connects those devices to the Internet via 3G mobile broadband, providing high-speed web access virtually anywhere. The size of a handheld PDA, the PHS300 can operate on battery power for up to 2 hours.

## **CradlePoint Solution Saves the Day at On-site Event**

PHS300 Personal Hot Spot Provides Web Access for High-Level Meetings Between Bloggers and HP

### **SITUATION**

Buzz Corps is an influencer marketing agency focused on generating word-of-mouth referral for their clients. One aspect of their services involves connecting Buzz Corps' clients with bloggers who write about those clients. For one of their recent initiatives, Tom Augenthaler and Nick White of Buzz Corps hosted a Tech Day event involving members of the HP Technology Solutions Group (enterprise servers, networking, etc.) and 10 IT pro-oriented bloggers from around the world. These bloggers traveled from Canada, Italy, Netherlands, New Zealand and cities around the United States for in-person, hands-on experiences with HP's newly launched line of servers. In the sessions, the bloggers received deep-dive briefings about the HP new products and associated technologies, plus took a tour of the manufacturing facilities. To report on their findings and involve their audiences in real-time discussions—thus making the most of their time when actually in HP's presence—the bloggers needed to be able to send and receive email and post to their blogs in real-time.

### **CHALLENGE**

While the HP site offered Internet connectivity in specified visitor meeting rooms, the bloggers and the HP team members were in a secure conference room because of

the unique nature of the Tech Day briefings. “Due to security considerations, network access to the Internet was not available for anyone who was not an authorized HP user,” Tom recalls. “This obviously caused huge problems for our blogger guests. When we made the announcement that there wasn’t going to be any Internet access, there were audible groans.”

“Given the ease of use, quality and the low cost, [the PHS300] is a sure winner.” ))

This type of security policy is quite common at large corporations. To protect intellectual property, trade secrets and other confidential information, IT departments typically impose strict network/Internet access restrictions. Efforts to work around these prohibitions require significant lead time and non-trivial expense. Even then, work arounds are sometimes just not possible, as was the case in this instance.

## SOLUTION

Fortunately, one of the bloggers, John Obeto of Absolute Vista, had a CradlePoint PHS300 Personal Hot Spot.

“John plugged a 3G [mobile broadband] air card into his PHS300 and within 2 minutes he had a wireless hot spot up and running,” says Tom. “He gave everyone a generic logon and password and we were all connected to the Internet just like that. I was getting email and checking the web...bloggers were posting to their blogs...even the Intel and HP guys were using it. It was an amazing experience. Everyone in the room was asking: ‘Where did you get this?’ Who makes it? Where can I get one?”

Nick adds: “I’ve run into this problem while at Buzz Corps and also in my previous job at Microsoft. There always seems to be issues with getting Internet access, obtaining approvals, securing provisioning by the IT department, etc.”

“And actually, it’s kind of embarrassing,” Tom interjects. “We have personal relationships with these bloggers, their families and their communities. I felt awful having to tell someone—after they’ve just flown 14 hours from New Zealand—‘sorry, no Internet,’ when that’s how they make their livelihood. The

CradlePoint [PHS300] really saved the day. These people are all heavy technology users and they were really impressed. We’re getting one for our company.”

“The cost was a pleasant surprise,” Nick continues. “If the price was north of \$600 or \$700, we’d have to think about it. But for less than \$190, it’s a no-brainer. Even if we used it just once—and we obviously will use it much more than that—[the PHS300] will pay for itself.”

## BENEFITS

“Before, if someone had an air card, they’d be the only one with an Internet connection and everyone else would be left out in the cold,” Tom notes. “Now, with a single air card, we can provide Internet for attendees at our events.

- **Easy.** “[The PHS300] was plug-and-play,” Tom reports. “It was like one-two-three-boom! It was up and running.”
- **Fast.** “[The PHS300] wasn’t as fast as a T-1 connection,” notes Nick. “But with 10 bloggers, plus Tom, me and the HP / Intel people all using it, we had pretty decent speeds. Obviously, upload and download speeds are more a function of the mobile broadband connection, not the PHS300.”
- **Reliable.** “The two days of the HP event,” reports Tom, “we didn’t experience a single problem. Even when I closed my laptop and it went to sleep, there were no drops. The connection would be there when I opened my laptop and it woke up.”
- **Affordable.** “After investing thousands of dollars in an event, spending a few extra dollars to ensure attendees have Internet access is well worth it,” notes Nick. “And we already have a mobile broadband account, so that cost isn’t an issue.”

Tom summarized his experience with the PHS300: “We hadn’t heard of CradlePoint before this HP event. From now on, we’re going to have one in our arsenal. It will allow us to always have Internet connectivity and be compliant with our clients’ security policies. Plus it will make us look smart to use cutting edge technology that resolves a long-standing problem that’s pervasive and frustrating.”



The CradlePoint CBA250 Cellular Broadband Adapter connects to the scale's management console to enable remote diagnostics and maintenance. The CBA250 provides IP Pass-Through capabilities for a LAN device requiring wireless broadband access, converting Ethernet to cellular and cellular to Ethernet. The CBA250 handles the connection without configuration and supports multiple and concurrent application streams. The size of a handheld PDA, it's truly a "drop-in" solution.

## **CradlePoint Enables Administrators to Remotely Access Industrial Scales**

**CBA250 Cellular Broadband Adapter Is a Fool Proof Way to Administer Industrial Scales Over Long Distances**

### **SITUATION**

C.T.P.Z. Application Innovations provides custom software solutions for large industrial scales. These industrial scales are used to weigh railroad cars, trucks, grain, coal, materials moving on conveyors, etc. The founder of C.T.P.Z. Application Innovations, Stephan Horlak, often partners with distributors like Dean Smith of D&G Scale to cooperatively develop custom solutions that allow industrial scale owners to extract custom data and reports, based on that owner's individual needs and requirements. Typically, these custom solutions are deployed on different models of Mettler-Toledo industrial scales. Mettler-Toledo scales have Ethernet ports that allow access to the scale's software system. Using a laptop, Stephan, can upload his custom applications (which use an API provided by Mettler-Toledo), deliver patches/fixes and add functionality as a customer's needs evolve.

### **CHALLENGE**

Industrial scales are deployed all over the country, far from the company's main Ohio location. Traveling to a site each time it needs an update or upgrade is expensive and

time-consuming. Further, many of the locations that use these scales—for example, gravel pits, coal mines, power plants, train yards, etc.—are located far from urban areas, so getting a local area technician to the site can require hours of travel.

## SOLUTION

“My [CradlePoint] CBA250 [Cellular Broadband Adapter] plugs into the Ethernet RJ-45 port of the scale. Using its mobile broadband connection, the CBA250 makes the scale accessible to me over the Web,” says Stephan. “It’s as if I was right there at the scale with a laptop. Only I’m not. I’m sitting in the comfort of my office with all the resources I need.”

“The CBA250 is foolproof. You just plug it in and it works. I’ve never had a problem.” )))

The first few weeks of operations of a new industrial scale are when most patches and upgrades to the custom software typically occur. “Before I started using the CradlePoint, I’d have to contract with a skilled service technician to go out to the site,” explains Stephan, “and you don’t want to know what service companies are charging per mile. Then once the tech got to the site, he would connect his laptop to the scale’s Ethernet port and then we’d troubleshoot together, with me on the phone talking him through the diagnostics or the upgrade. It was tedious and frustrating process.”

With the CBA250, Stephan no longer has to dispatch a high-cost technician to the site. “Pretty much anyone that can drive a car can do the job,” says Stephan. “They just plug the CBA250 into the RJ-45 port and then step back while I do the troubleshooting or upgrade the software remotely.”

There are two areas where Stephan plans to expand his use of the CBA250. “Instead of waiting for feedback to come in on new installs and then reacting with a service call,” explains Stephan, “we’re going to partner with folks like Dean Smith of D&G Scale and proactively attach a CBA250 with an air card to the scale for the first few weeks, so we can immediately tweak and adjust as issues come up.”

That leads to the third scenario. “A lot of these scales are in outbuildings or remote sites that are far from any kind of

network. Yet owners and managers need the data from the scale for accounting and operational purposes. So they send a person out to the scale once a day or once every other day to collect print outs or download information. Well, that’s really inefficient. But to run fiber to the scale or set up a point-to-point wireless bridge costs \$5,000 to \$30,000, so no one is going to spend that.”

But with a CradlePoint CBA250 Cellular Broadband Adapter attached to the scale (about \$180), plus the cost of an air card (about \$240) and a monthly mobile broadband account (about \$55), a main office can access that data for a fraction of what it would cost to connect using conventional means. “The savings are tremendous, whether in terms of installation cost, or even the cost of driving back and forth to the scale all the time. Also, some companies rely on the paper tickets printed out by the scales to track load weight, time of weighing, etc. Well, drivers can lose tickets pretty easily. But you can’t lose data that you’re pulling directly from the scale onto your computer. Plus it eliminates manual keystroking that’s just wasteful.”

## BENEFITS

- **Easy.** “The CBA250 is foolproof,” Stephan reports. “You plug it in and it just works. No set up. No reset button. It’s perfect for those isolated areas where there’s no IT help within a hundred miles.”
- **Reliable.** “I’ve never had a problem,” declares Stephan. “Not one instance.”
- **Money-saving.** “The CBA250 puts me and my software programmers right inside a scale...for a fraction of the cost of actually traveling to the site,” notes Stephan.
- **Pervasive.** “There is almost no industrial scale site that doesn’t have some sort of mobile coverage,” says Stephan. “If you can make a phone call, you can send and receive data. All I have to do is ask the locals which mobile service to use in what location and they know.”
- **Affordable.** “Even if it was \$500, it would be worth it,” says Stephan. “But \$180 is even better.”

Stephan sums up his plans for using CradlePoint solutions: “If I can sit at my desk and make a two-line code change in two minutes that solves a customer’s problem, versus spending hundreds of dollars on an on-site visit, that’s a huge benefit for me and my customers.”



The CradlePoint CTR350 Mobile Broadband Travel Router instantly creates a Wi-Fi hotspot that any Wi-Fi enabled device can connect to—laptop, camera, PDA, etc. The CTR350 then connects those devices to the Internet via mobile broadband, providing high-speed web access virtually anywhere. In addition, it can also connect to the Internet via a DSL or Cable broadband modem.

## Construction Company Uses CradlePoint to Remotely Monitor Construction Sites

Project Manager Monitors Subcontractors and Deliveries to Job Site Over the Internet Using Web Cam and CradlePoint CTR350...All Powered by Solar Panels

### SITUATION

Nelson Homes builds modular homes all across the state of Virginia. Efficiently coordinating deliveries, subcontractors and employees requires awareness of what materials have been delivered to a job site, which subcontractors have completed their work (so follow up activity can be scheduled) and what sites are ready for his employees.

### CHALLENGE

As budgets have gotten tighter, Rob Rutherford of Nelson Homes has had to act as the construction manager on more and more jobs spread over a wider area. "Things are tough out here in the construction business," says Rob. "We've had to do more with fewer people. So I can't afford to drive 3 hours to check in on a single job site." Rob started looking for a way that he could "see" a job site without actually

having to travel to it. He looked at off-the-shelf web cam systems, which would allow him to view job sites over the Internet right from his computer. However, he quickly found that they cost thousands of dollars. He explored an option of tying web cameras into the GPS units on his company trucks, but couldn't make that work. Next, he started looking into 3G/broadband mobile connectivity via air cards that deliver Internet access for laptops. And that's when he found CradlePoint.

## SOLUTION

"I stumbled across the CradlePoint routers while I was doing a web search on air cards," Rob recalls. "As I read about them and saw that they could provide a hot spot for the web cam and that one of the units could run on a battery, I knew I found what I was looking for."

"[The CTR350] is so portable, I can easily move it from job site to job site." )))

Rob connected a web cam to a CradlePoint CTR350 using its Ethernet port. The CTR350 then connected the web cam to the Internet through an Alltel air card. Rob powered the entire package with solar panels. While off-the-shelf systems ran into the thousands, Rob was able to put together his do-it-yourself monitoring solution for less than \$750.

With the IP camera, Rob can remain in his office and check on a job site from his desktop computer. He's able to make sure that deliveries have arrived on site so that employees can be correctly scheduled. And he can confirm that work has been completed by one set of subcontractors before calling in the next wave.

Another way Rob plans to use his remote monitoring solution is to allow customers to see the progress of their homes being built. He plans on offering clients a web page that will let them to look at the job site without having to physically drive to the site. "It will enable clients to stay informed of the progress of their home and avoid that valley of despair that often occurs between the time a customer signs the initial contract until the home is finally completed. The more they can see what's going on, the better."

## BENEFITS

- **Easy.** "I know a little about routers, but I'm not an expert by any means," Rob notes. "I plugged [the CTR350] in, and it worked. It couldn't have been easier. I logged in with the password on the box, found the IP address just like the [QuickStart] instructions said and it hooked up just fine. Adding the web camera was no problem."
- **Reliable.** "[The CTR350] has been up and functioning all the time," reports Rob. "Before I got the solar panels working right, I had to reboot one or two times, but since then, it's been solid."
- **Portable.** "Most job sites don't have electricity, so being able to run it off the battery is important," says Rob. "[The CTR350] is so portable, I can easily move it from job site to job site. In fact, my son and I went on a couple of trips and brought the CTR350 along. He had his laptop and I had mine and we both had Internet [access] any time we wanted all the way from central Virginia to central Tennessee."
- **Affordable.** "We're trying to conserve every penny we can," explains Rob. "I got [my CTR350] for a good price. It's a little more expensive than a standard router, but with all that it allows you to do and with all the high-end features, it's more than worth it."

Rob summarizes his experience with the CradlePoint CTR350: "If I don't have to drive up to a construction site, but still can see what's going on, that's a real help. I'm planning on putting together another two monitoring units and I'm looking forward to saving even more time, thanks to the CradlePoint [CTR350]."



The CradlePoint CTR500 instantly creates a Wi-Fi hotspot on Martz motorcoaches that any Wi-Fi enabled device can connect to—laptop, PDA, camera, phones, etc. The CTR500 connects to the Internet via 3G/4G mobile broadband networks (e.g., Verizon, Sprint, AT&T, etc.) using a USB air card. The result is reliable web and email access for Martz Trailways customers. Anywhere...anytime.

## CradlePoint Provides Mobile Broadband Internet Access for Busline Passengers

Martz Trailways Uses CradlePoint Routers to Provide Wi-Fi Service to Its Passengers On the Road.

### SITUATION

Martz Trailways ([www.martztrailways.com](http://www.martztrailways.com)) is a motorcoach company with over 80 vehicles. Each day, Martz Trailways transports approximately 2,300 people to New York city for work, school, and leisure. In addition, Martz offers charter services to schools, college and university groups, senior groups, religious groups, military moves, children's camps, professional sports teams, bus banks, tour operators, and individuals needing motorcoach transport throughout the eastern United States.

### CHALLENGE

Martz Trailways wanted its drivers to be able to accept and validate passenger tickets electronically (versus collecting paper tickets and bringing them back to the office for manual entry into the system). This required Internet connectivity for their motorcoaches. But when the company first began looking at mobile broadband routers, the cost was prohibitive: "The initial options for routers were priced at \$700 and up, which seemed to be too pricey when you consider we have over 80 vehicles," reports General Manager, Bob Chepalonis. "Plus, the units were too large—about the size of a laptop. We needed something compact that could tuck away out of sight."

As Martz continued to explore options, their vendor pointed the company to CradlePoint routers. “The solution of an economical router came to us from the Gateway software people, who were helping us with the paperless ticketing system. When we investigated CradlePoint, the price point was excellent. No one else came close,” says Bob. “In addition, the CradlePoint CTR-500 that we chose is about the size of a BlackBerry PDA, and the air card doesn’t stick way out, so we could install it in a concealed, out-of-the-way spot where no one could tamper with it.”

“The price point was excellent.  
No one came close.” )))

The company plans to have the backend of the paperless ticketing system in place by summer. In the meantime, the CradlePoint mobile broadband infrastructure is the first piece to be put into place. “With paperless ticketing, our drivers will just scan a bar code on the ticket and the information will go through the CradlePoint router, over the Internet and right to our back office,” notes Bob. “We’ll be able to view data in real-time, instead of the two-week lag that the current manual process entails.”

Bob continues: “In addition, our customers had been asking for Wi-Fi access for a while, but the cost was just too prohibitive. But now, CradlePoint makes it affordable. In fact, we use Wi-Fi as a marketing tool to attract new riders. Customers have positively commented on the free Wi-Fi we offer. Better yet, our competition does not offer it.”

## BENEFITS

- **Simple.** “Installation was very simple,” notes Bob. “We wired it to a “keyed-on” power source, so it will reset on every start.”
- **Reliable.** “We’ve been using the CradlePoint routers for over 6 months now on our motorcoaches,” reports Bob, “and we have had no failures.”
- **Performance.** “The fact that we’ve had no complaints from customers about speed or performance speaks for itself,” says Bob.
- **Robust Feature Set.** “With the functionality offered in the admin menu, we were able to lock out certain websites that eat up a lot of bandwidth, like YouTube, while still allowing customers normal Internet and email use,” explains Bob. “This enables us to stay under the 5GB/month data plans that are offered.”
- **Support.** “On the initial setup, the one broadband card from Verizon was not compatible with the router,” reports Bob. “CradlePoint went to Verizon and was able to have that as a compatible card within a few days. That is pretty good support!”
- **Affordable.** “CradlePoint was the most economical choice when we first got them,” says Bob. “And they’re still the most economical choice.”

Bob adds one final thought: “The CradlePoint routers were small enough that we could install them out of sight. That helps us maintain a clean, professional look inside our motorcoaches.”





The CradlePoint MBR1000 instantly creates a Wi-Fi hotspot that any Wi-Fi enabled device can connect to—laptop, camera, PDA, etc. The MBR1000 connects devices to the Internet in two ways: via 3G mobile broadband using an EVDO or USB air card, providing high-speed web access virtually anywhere. Or it can also be plugged into a DSL or cable modem.

## Jackson-Hewitt Franchisee Speeds Retail Site Deployment with Cradlepoint

MBR1000 Broadband Router Helps Reduce Set Up Time from Weeks to One Hour

### SITUATION

During tax season, Jackson-Hewitt of northern Georgia offers tax preparation services in retail locations like Wal-mart and K-mart. They set up temporary kiosks in these retail locations that require Internet access and phone service.

### CHALLENGE

Provisioning broadband DSL line and phone lines every tax season was costly, time-consuming and frustrating. Just ask Jackson-Hewitt franchise owner John Beazle. "Have you ever tried to get a DSL line into a Wal-mart?" he asks with a laugh.

Beazle detailed some of the difficulties:

- Because Beazle's Jackson-Hewitt offices cover considerable territory in northern Georgia, he must coordinate with 4 different phone companies to provision the 5 different store locations his kiosks are in
- There is a 5-10 day wait for the different phone companies to send field technicians to the retail sites

- Beazle must coordinate with each store manager to ensure his operations don't interfere with the store's existing IT infrastructure
- The day of installation, Beazle or one of his employees must be at the Wal-mart or K-mart all morning or all afternoon because the phone companies can't specify a time when they will be on-site
- Installation and setup costs run about \$300 per site; then there are the monthly fees (usually higher since he's on month-to-month contracts for the 4 months of tax season)
- Each year, the new phone numbers of the sites which must be communicated throughout his organization
- At the end of tax season, the DSL and phone service at each site must be cancelled and disconnected

## SOLUTION

This year, John Beazle got a CradlePoint MBR-1000 Broadband Router for each location. Because the CradlePoint MBR-1000 uses 3G/broadband cellular to connect to the Internet, it provides the broadband connectivity his employee's computers need...without the provisioning or installation hassles of DSL or cable. "I walk in with everything I need. With the MBR-1000, in less than an hour, the kiosk is up and running and ready to go. No waiting. No relying on anyone but me."

This year, Beazle's Jackson-Hewitt office is also implementing a new VoIP phone system. This allows the retail sites to become extensions of his main phone network. Their VoIP phones plug right into the MBR-1000. This eliminates the need to pay for new phone lines or individual phone numbers. More importantly, it gives his customers a better experience. "Someone calls into the main number and they can get transferred to the retail site seamlessly. It's much smoother and delivers better customer service."

Beazle also appreciates the MBR-1000 VoIP optimization capabilities. The MBR-1000 dynamically prioritizes VoIP packets to provide the highest call quality possible. "No other router in the price range has that kind of capability," says Beazle. "I can't believe the MBR-1000 is so inexpensive. And reliable, too. We've had zero downtime."

## BENEFITS

John Beazle and his Jackson-Hewitt franchises have realized a number of advantages by using the CradlePoint MBR-1000 Broadband Router:

- Save time, money and frustration, while delivering better service to their customers
- Just one 3G broadband provider to deal with instead of 4 different phone companies

"I can't believe the MBR-1000 is so inexpensive. And reliable, too. We've had zero downtime." )))

- No reliance on third parties so retail kiosks can set up whenever it's convenient
- Store managers no longer have to worry about the impact of foreign DSL lines and phone lines
- Zero installation or setup costs
- VoIP phones at each retail site become extensions of the main phone system, enhancing customer service, eliminating the need to learn new phone numbers and reducing costs
- At the end of tax season, the MBR-1000 and 3G cellular broadband service will enable Beazle and his employees to work remotely, providing greater flexibility and quality of life

One more thing John likes about the MBR-1000. "It's really user friendly. It's so easy to setup, my 12-year old granddaughter could do it. I'm sharing my experiences with other Jackson-Hewitt franchises. They face the same challenges as I do and they're really excited."



The CradlePoint MBR1100 enables VPN sessions over the Internet. The MBR1100 instantly creates a Wi-Fi hotspot that any Wi-Fi enabled device can connect to—laptop, camera, PDA, etc. The MBR1100 then connects the devices to the Internet via 3G/4G mobile broadband using an EVDO ExpressCard or USB air card. It can also use a DSL or cable modem landline to connect to the Internet.

## Plumbing Contractor Saves \$10,000 and Improves Service with CradlePoint

DJ Data Solutions Installs CradlePoint Routers in Service Trucks and Saves Plumbing Contractor the Pain of Buying New Handhelds and Migrating Wireless Providers

### SITUATION

DJ Data Solutions provides custom software development and handheld applications in Madison, Wisconsin. One of its clients—Benjamin Plumbing—has a four-truck service fleet. Each truck carries about 2,500 parts in inventory that are bar coded for pricing. The company wanted its service field techs to be able to use their existing MC9000 handheld scanners to scan bar codes of parts used on service calls. Then, the techs would use the MC9000 scanners to print invoices on the spot using wireless printers installed in the trucks. In addition, the company wanted to be able to send scheduling updates and new job tickets to the MC9000 scanners while the techs were out on the road. Finally, Benjamin Plumbing wanted it all to communicate with their back-end accounting software.

### CHALLENGE

David Harrison, President of DJ Data Solutions, faced a number of issues. The MC9000 scanners the company owned—while Wi-Fi enabled—were not equipped to communicate using 3G / broadband mobile service. This prevented them from connecting directly with the office. Scanners that did have 3G / broadband mobile

connectivity were available, but buying four of them would have cost more than \$10,000. Further, 3G-enabled scanners are compatible with a limited number of wireless providers (e.g., AT&T, Verizon and Sprint). Benjamin Plumbing had a long-term contract with a regional wireless provider—U.S. Cellular—that 3G-enabled scanners do not support. Thus, even if Benjamin Plumbing could afford to pay \$10,000 for 3G-enabled scanners, they'd still have to undertake a highly-expensive and disruptive migration to switch wireless providers.

“The MBR1100 is simple to use [and] provides a lot of options for the price.” )))

## SOLUTION

David deployed a CradlePoint MBR1100 Mobile Broadband 'N' 3G/4G Router with VPN in every truck. The MBR1100 creates a W-Fi spot that each MC9000 scanner and wireless printer can connect with. A USB modem plugged into each MBR1100 connects it to the Internet via the company's U.S. Cellular broadband wireless service. This approach solved the problem for about one-tenth the cost of buying new scanners while avoiding the pain of switching providers.

“The MBR1100 allowed us to develop a solution that works with our customer's existing equipment,” says David. “It's simple to use, but at the same time, it provides a lot of options for the price.”

David continues: “For example, we use Virtual Private Network (VPN) connections to ensure security. With the MBR1100, we set up the VPN once and the field service guys never have to mess with it. Using the MBR1100 instead of Windows Mobile to establish the VPN connections is a big plus. VPN sessions in Windows Mobile tend to time out and reconfiguring or restarting a new VPN session is tricky. We wanted to avoid that. After all, these are plumbers, not computer techs.”

## BENEFITS

- **Simple.** “Setting up [the MBR1100] was pretty straightforward,” reports David. “Plus, I was able to save the first set up I did as a configuration file. Then I just uploaded that configuration file to each of the remaining three units. That saved quite a bit of time.”
- **Value.** “I think [\$350] is at the right price point,” notes David. “If you look at a Cisco firewall, they start at \$700 or \$800 and they go up from there.”
- **Support.** “CradlePoint support is very good,” notes David. “Very good. While configuring the VPN, I had questions about setting it up. When I called their support people, they were knowledgeable and helpful.”
- **Robust.** “I saw the Linksys, but didn't care for it,” says David. “[The MBR1100] gives you a lot more options. For example, it was pretty easy for me to limit each MBR1100 to specific IP ranges, so if the trucks are parked next to each other, the scanners don't get confused about which hotspot to use. I'm kind of surprised that [the MBR1100] came out with VPN capabilities and they kept the price where it is.”

David sums up his thoughts about the MBR1100: “Even though Benjamin Plumbing had equipment that was 4 years old, the MBR1100 made this solution work. It was less expensive than buying all new scanners. And my customer didn't have to switch providers.”

“On service calls Benjamin Plumbing is not yet doing credit cards with a reader, but when they do, we'll be able to take advantage of the MBR1100's hotspot. We'll save money on the credit card swipers, because we won't have to buy 3G-enabled models—they're more expensive—and we won't have to spend \$69 a month on a different 3G plan just to support the swipers.”

# Maximizing the Value of Your Mobile Broadband Service

## The Advantages of the WiPipe™ Platform

---

Every CradlePoint Mobile Broadband Router is built on the WiPipe™ platform, which is based on more than 27 patents pending. The WiPipe™ platform enables best-in-class performance, functionality, security, and interoperability while providing “plug-and-play” ease of use.

### Overview

This white paper looks at how users can maximize the value they get from their mobile broadband service plans. It explains how mobile broadband routers (also known as cellular routers or 3G/4G broadband routers) allow users to share their mobile broadband access via a Wi-Fi hotspot and/or Ethernet LAN connections. Further, it examines CradlePoint's WiPipe™ platform for mobile broadband routing and how it enhances security, ease of use, performance, functionality and management control.

### Mobile vs. wired broadband routers

Mobile broadband routers and wired broadband routers share a number of similar capabilities/functions:

- Connect to a broadband source for Internet access (generally this is a DSL, cable, satellite or T1 Internet service delivered via a wired network)
- Provide a 802.11 wireless LAN (a.k.a. Wi-Fi hotspot) that enables multiple Wi-Fi-enabled devices to share the broadband Internet connection
  - Laptops
  - Printers
  - Desktop PCs
  - PDAs
  - Gaming consoles
  - Any device capable of receiving a Wi-Fi signal
- Provide Ethernet port(s) that enable devices to share the broadband Internet connection through a wired connection
  - Desktop computer
  - Laptop
  - Printers
  - Server
  - Storage device/appliance
  - Network switch/print server
  - Any device with an Ethernet port

The two main differences between mobile and traditional wired broadband routers are:

1. Source of the broadband connection
2. Modem (the device that modulates/demodulates the broadband signal before it goes into the router)

	Source	Modem
<b>Wired broadband router</b>	<ul style="list-style-type: none"> <li>• DSL/T1/Fiber – phone service provider (e.g., SBC, Qwest, Ameritech, Bellsouth, AT&amp;T, etc.)</li> <li>• Cable – cable service company (e.g., Charter, Comcast, Cox, Time-Warner, etc.)</li> <li>• Satellite – satellite service provider (e.g., HughesNet, Wildblue, Skyway USA, Starband Satellite, etc.)</li> </ul>	<ul style="list-style-type: none"> <li>• DSL modem</li> <li>• T1 modem</li> <li>• Fiber modem</li> <li>• Cable modem</li> <li>• Satellite modem</li> </ul>
<b>Mobile broadband router</b>	<ul style="list-style-type: none"> <li>• Mobile/3G/4G – wireless or mobile provider (e.g., AllTell, AT&amp;T, Cricket, Ntelos, Sprint, Verizon, etc.)</li> </ul>	<ul style="list-style-type: none"> <li>• ExpressCard</li> <li>• USB air card</li> <li>• Handheld/Phone</li> </ul>

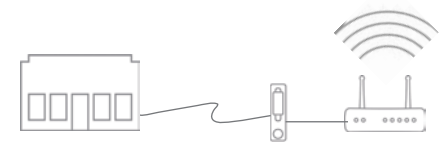

**Wired broadband router**

A wired broadband connection from a telephone or cable company central office terminates at a DSL/cable modem, which plugs into the conventional broadband router that then creates a Wi-Fi hotspot.

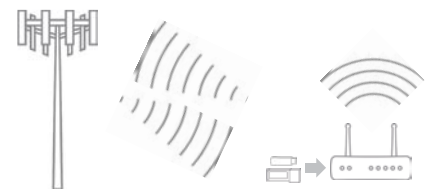

**Mobile broadband router**

A wireless broadband connection from a wireless service provider terminates at an ExpressCard and/or USB air card plugged into the mobile broadband router. The router then creates a Wi-Fi hotspot.

**The benefits of mobile broadband routers**

When mobile broadband/3G service first became available, users bought ExpressCards or USB air cards (modems) that plugged into their laptops. These modems established a mobile broadband connection to the Internet. Thus, users could get email, download music and surf the Internet at broadband speeds anywhere there was a mobile broadband/3G/4G signal. No hunting for Wi-Fi spots (or paying for them) or plugging into strange networks. The only problem? The mobile broadband connection was restricted to the laptop that had the ExpressCard or USB air card physically plugged into it and could not be shared.

Mobile broadband routers solve that problem and take the next logical step: allowing users of mobile broadband/3G/4G service to share their mobile broadband connection. Instead of plugging the ExpressCard or USB air card into an individual laptop, it gets plugged into the mobile broadband router. The mobile broadband router takes that fast mobile broadband connection and allows it to be shared by creating a Wi-Fi hotspot and/or by providing physical Ethernet jacks that other devices can plug into.

## **The WiPipe™ platform provides a better 3G/4G mobile broadband router experience**

The transport technology of mobile broadband is different from that of DSL, cable, T1, fiber and satellite. In order to maximize performance, compatibility and ease of use, it's critical that a mobile broadband router account for this difference. Router solutions that do not use the WiPipe™ platform usually start with conventional DSL/cable routing technology and then "bolt on" the mobile broadband component. But CradlePoint mobile broadband routers take as their starting point the inherent uniqueness of 3G/4G mobile broadband service. The WiPipe™ platform is built from the ground up for mobile broadband routing, enabling highly robust, efficient, powerful and interoperable router solutions, while maintaining "plug-and-play" simplicity.

The WiPipe™ platform is built from the ground up for mobile broadband routing. )))

### **Making robust functionality and high-performance...simple**

The first, most immediately noticeable aspect of the WiPipe™ platform is how simple CradlePoint routers are to set up and use. CradlePoint mobile broadband routers plug in and start working right out of the box. There is no software to install or drivers to download. Yet even with this easy, plug-and-play setup, the WiPipe™ platform provides enhanced security protection. Here's how: the first time a user starts up a CradlePoint router, he or she enters a code—printed on the side of the product box—to access the router's Wi-Fi network. This simple layer of added security requires tight integration between firmware, hardware and packaging operations. Then the user has the opportunity to establish even tighter, enterprise-levels of security. The end result is higher security and a simplified experience for users.

Another example of how the WiPipe™ platform simplifies operations: the user interface is laid out so commonly used features and functions—the ones used by an overwhelming majority of customers—are automatically implemented through simple, point-and-click wizards. Yet for power users, the WiPipe™ platform provides a comprehensive menu of user-configurable options that allow robust control of security, performance, access, maintenance and other functions

### **Specifically tuned for 3G/4G mobile broadband**

The WiPipe™ platform employs highly optimized software that incorporates algorithms which assess the link quality of the connection and accelerate certain packets to ensure that the user-experience is optimized. Routers built on generic platforms lack this optimization and are not able to provide the performance, security and reliability necessary to meet business-critical demands.

Further, solutions that don't use the WiPipe™ platform typically employ non-optimized drivers for their USB air card or ExpressCard interface. These "canned" drivers often incorporate many services that are unnecessary and/or superfluous. The result can be slower startup and sluggish throughput, as well as potential compatibility issues.

CradlePoint engineers work closely with manufacturers of USB air cards and ExpressCards to build drivers tailored specifically for their particular modem implementation. This ability to control hardware and software at a fundamental, OS level provides a number of benefits:

- Cleaner, leaner interface for faster start up
- Maximum compatibility/interoperability with the greatest number of USB air cards and ExpressCards
- Peak efficiency with all carriers and signal types
- Optimum throughput for best-possible performance

### **Dynamic optimization for the greatest performance under changing mobile broadband conditions**

A WiPipe™-powered router is capable of identifying the wireless environment in which it is deployed, and as the mobile environment changes from session to session, can automatically self-configure for best performance. Not only can the WiPipe™ platform determine a mobile broadband router's position within the carrier infrastructure and provide information to the user as to changes in available service levels, it can also detect interfering traffic in the immediate area and change its local broadcast configuration to minimize interference and optimize throughput.

### **Load balancing optimized for 3G/4G mobile broadband**

Load balancing for conventional broadband environments is often implemented through hardware. But the special circumstances of mobile/3G/4G broadband routers require a different approach. Some CradlePoint router models can accommodate up to three USB air cards/ExpressCards connections (plus an Ethernet WAN connection). The WiPipe™ platform can load balance between the three mobile broadband sources, providing, in effect, a single "aggregated stream" that maximizes throughput to a degree that no other mobile/3G/4G broadband router can match.

### **Best-in-class Quality of Service features**

The WiPipe™ platform incorporates high-end Quality of Service capabilities that are typically found only in much more costly solutions. For example, other routers within the class handle VoIP optimization by reserving a certain amount of the available bandwidth strictly for VoIP packets at all times. That means that there is always less bandwidth available for non-VoIP packets, even when there is no VoIP traffic.

On the other hand, the WiPipe™ platform offers dynamic optimization for VoIP packets. This provides great voice quality and clarity for VoIP calls. But when there is no VoIP traffic, other packets can take full advantage of the maximum available bandwidth. Even under demanding conditions—for example simultaneous VoIP calls and streaming video, a CradlePoint router can deliver the highest levels of service for both applications.



Other Quality of Service features include prioritizing traffic for various wireless applications (like video conferencing), specific application protocols and specific computers on the wireless network.

### Automatic Failover protects against DSL/cable outages

In select CradlePoint mobile broadband router models, the WiPipe™ platform provides Automatic Failover protection. If DSL/Cable/T1/Fiber is the primary source of broadband connectivity, a user can also plug in an ExpressCard and/or USB air card into the CradlePoint router, and configure it for failover. In the event of a DSL/Cable/T1/Fiber outage, the CradlePoint router senses the problem and automatically switches to mobile broadband Internet service. All wired and Wi-Fi devices connected to the CradlePoint router continue to operate at broadband speeds without interruption. When the DSL/Cable/T1/Fiber connection is restored, the CradlePoint router automatically switches back. No user intervention is needed.

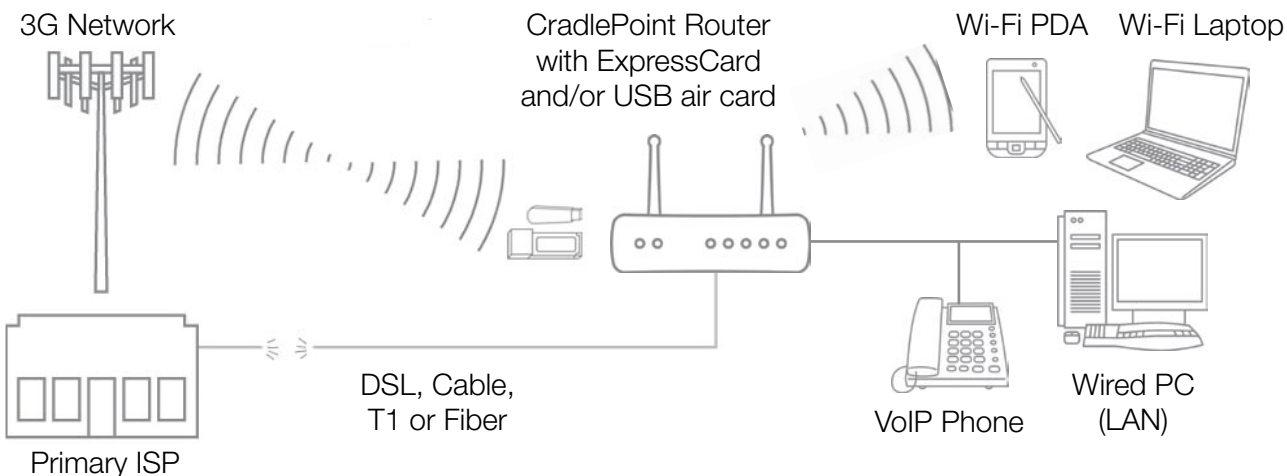

1. Outage occurs at primary ISP or DSL/Cable/T1/Fiber provider.
2. Sensing outage, the WiPipe™ platform automatically switches to the mobile broadband connection (less than 60 seconds).
3. All wired and WiFi devices connected to the CradlePoint router continue to operate at broadband speeds without interruption.

### Added-value VPN functionality

Virtual Private Networks (VPNs) provide a secure connection between two public endpoints, ensuring the confidentiality of the data that passes between them. Most mobile broadband providers offer a VPN service option. However, this service option typically requires the purchase of a new air card, new service setup and higher monthly fees.

With CradlePoint routers and the WiPipe™ platform, users can create up to five secure VPN tunnels simultaneously...without the expense and hassle of purchasing a VPN service option. What's more, the encryption ciphers/algorithms employed by the WiPipe™ platform are far more robust than the VPN encryption offered by non-WiPipe™-powered solutions at similar price points.\*

### **Enhanced security/filtering options**

In addition to the base-level security of the login page, the WiPipe™ platform supports multiple levels of security, including: WEP, WPA-Personal, and WPA-Enterprise. The WiPipe™ platform enables access control that can limit access to approved sites, limit web access based on time or dates, and/or block access from applications such as P2P utilities or games.

### **Optimized Wi-Fi performance**

Not only does the WiPipe™ platform maximize performance on the mobile/wireless side of the equation, it also enhances Wi-Fi and Ethernet performance. CradlePoint's Wi-Fi subsystem is tested to ensure compatibility with the greatest number of Wi-Fi devices. As part of the WiPipe™ platform, all CradlePoint routers are certified by the Wi-Fi Alliance—the governing body for Wi-Fi standards. This third party certification ensures interoperability and adherence to Wi-Fi standards, which provides additional confidence for users.

### **Conclusion**

The WiPipe™ platform is based on more than 27 patents pending. The over arching principle is to provide highly robust capabilities, a powerful feature set and superior performance, while maintaining maximum, security, compatibility/interoperability and ease of use. The results are valuable benefits for all users—whether they are beginners or sophisticated power users:

- Robust functionality and high-performance that's simple
- OS/ drivers specifically tuned for mobile/3G/4G broadband
- Load balancing optimized for mobile/3G/4G broadband
- Best-in-class Quality of Service features
- Automatic Failover protection against DSL/cable/T1/Fiber outages
- Added-value VPN functionality
- Enhanced security/filtering options
- Optimized Wi-Fi performance

## Free Manuals Download Website

<http://myh66.com>

<http://usermanuals.us>

<http://www.somanuals.com>

<http://www.4manuals.cc>

<http://www.manual-lib.com>

<http://www.404manual.com>

<http://www.luxmanual.com>

<http://aubethermostatmanual.com>

Golf course search by state

<http://golfingnear.com>

Email search by domain

<http://emailbydomain.com>

Auto manuals search

<http://auto.somanuals.com>

TV manuals search

<http://tv.somanuals.com>