

Operator's Manual

CRAFTSMAN®

P R O F E S S I O N A L

Zero Turn Riding Mower

26HP B&S Engine / Side Discharge / 52-inch Wide

Model 127.28875

· Español, p. 37



CAUTION: Before using this product, read the manual and follow all its Safety Rules and Operating Instructions

For answers to your questions about this product call:

1-800-659-5917

Sears Craftsman Help Line

5am - 5pm, Mon - Sat

Sears, Roebuck and Co., Hoffman Estates, IL 60179 U.S.A

Visit the Craftsman website: www.sears.com/craftsman

MAN 4163202 Rev. A 11-2007 PARTS MANUAL 4163201

CALIFORNIA
Proposition 65 Warning

Diesel engine exhaust and some of its constituents are known to the State of California to cause cancer, birth defects and other reproductive harm.

⚠ WARNING

The engine exhaust from this product contains chemicals known to the State of California to cause cancer, birth defects or other reproductive harm.

Californie Proposition 65 Avertissement

Les échappements des moteurs diesel et certains de leurs composés sont reconnus par l'Etat de Californie pour être cancérigènes, provoquer des défauts congénitaux et d'autres dangers en matière de reproduction.

California Advertencia

⚠ AVERTISSEMENT

L'émission du moteur de ce matériel contient des produits chimiques que l'Etat de Californie considère être cancérigènes, provoquer des défauts congénitaux et d'autres dangers en matière de reproduction.

de la Proposición 65

El estado de California hace saber que los gases de escape de los motores diesel y algunos de sus componentes producen cáncer, defectos de nacimiento y otros daños en el proceso de reproducción humana.

⚠ ADVERTENCIA

El estado de California hace saber que los gases de escape de este producto contienen productos químicos que producen cáncer, defectos de nacimiento y otros daños en el proceso de reproducción humana.

CALIFORNIA
Proposition 65 Warning

Battery posts, terminals, wiring insulation, and related accessories contain lead and lead compounds, chemicals known to the State of California to cause cancer and birth defects or other reproductive harm.
WASH HANDS AFTER HANDLING.

TABLE OF CONTENTS	PAGE
SAFETY.....	2-8
LABELS.....	9-13
CONTROLS.....	14-17
PRE-OPERATION CHECK LIST.....	18
OPERATION.....	19-21
MAINTENANCE CHART.....	22
MAINTENANCE RECORD.....	23
MAINTENANCE.....	24-30
ADJUSTMENTS.....	31-33
BELT REPLACEMENT.....	34
SERVICE INFORMATION.....	BACK PAGE

WARRANTY

CRAFTSMAN PROFESSIONAL LIMITED WARRANTY

Two Years on Tractor

When operated and maintained according to all supplied instructions, if this tractor fails due to a defect in material or workmanship within two years from the date of purchase, call 1-800-4-MY-HOME® to arrange for free repair.

This warranty applies for only one year from the date of purchase if this tractor is ever used for commercial or rental purposes.

During the first 30 days of purchase, there will be no charge to service the tractor in your home. For your convenience, in-home warranty service will still be available after the first 30 days of purchase, but a trip charge will apply. This charge will be waived if you transport the tractor to an authorized Craftsman drop-off location. For the nearest authorized location, call 1-800-MY-HOME®.

90-Days on Battery

For ninety (90) days from the date of purchase, if the battery included with this tractor is defective in material or workmanship (our testing proves it will not hold a charge), it will be replaced free of charge.

During the first 30 days of purchase, there will be no charge to replace the defective battery in your home. For your convenience, in-home warranty service will still be available after the first 30 days of purchase, but a trip charge will apply. This charge will be waived if you transport the tractor to an authorized Craftsman drop-off location. For the nearest authorized location, call 1-800-MY-HOME®.

This warranty covers ONLY defects in material and workmanship. Sears will NOT pay for:

- Expendable items that become worn during normal use, including but not limited to blades, spark plugs, air cleaners, belts, and oil filters.
- Standard maintenance servicing, oil changes, or tune-ups.
- Tire replacement or repair caused by punctures from outside objects, such as nails, thorns, stumps, or glass.
- Tire or wheel replacement or repair resulting from normal wear, accident, or improper operation or maintenance.
- Repairs necessary because of operator abuse, including but not limited to damage caused by towing objects beyond the capability of the tractor, impacting objects that bend the frame or crankshaft, or over-speeding the engine.
- Repairs necessary because of operator negligence, including but not limited to, electrical and mechanical damage caused by improper storage, failure to use the proper grade and amount of engine oil, failure to keep the deck clear of flammable debris, or failure to maintain the equipment according to the instructions contained in the operator's manual.
- Engine (fuel system) cleaning or repairs caused by fuel determined to be contaminated or oxidized (stale). In general, fuel should be used within 30 days of its purchase date.
- Normal deterioration and wear of the exterior finishes, or product label replacement.

This warranty applies only while this product is within the United States.

This warranty gives you specific legal rights, and you may also have other rights, which vary, from state to state.

Sears, Roebuck and Co., Hoffman Estates, IL 60179

11-2007

SAFETY

NOTICE !!!

Unauthorized modifications may present **extreme** safety hazards to operators and bystanders and could also result in product damage.

Craftsman Professional strongly warns against, rejects and disclaims any modifications, add-on accessories or product alterations that are not designed, developed, tested and approved by Craftsman Professional Engineering Department. Any Craftsman Professional product that is altered, modified or changed in any manner not specifically authorized after original manufacture—including the addition of “aftermarket” accessories or component parts not specifically approved by Craftsman Professional—will result in the Craftsman Professional Warranty being voided.

Any and all liability for personal injury and/or property damage caused by any unauthorized modifications, add-on accessories or products not approved by Craftsman Professional will be considered the responsibility of the individual(s) or company designing and/or making such changes. Craftsman Professional will vigorously pursue full indemnification and costs from any party responsible for such unauthorized post-manufacture modifications and/or accessories should personal injury and/or property damage result.



This symbol means:
ATTENTION!
BECOME ALERT!

Your safety and the safety of others is involved.

Signal word definitions:

The signal words below are used to identify levels of hazard seriousness. These words appear in this manual and on the safety labels attached to Craftsman Professional machines. For your safety and the safety of others, read and follow the information given with these signal words and/or the symbol shown above.

DANGER

DANGER indicates an imminently hazardous situation which, if not avoided, **WILL** result in death or serious injury.

WARNING

WARNING indicates a potentially hazardous situation which, if not avoided, **COULD** result in death or serious injury.

CAUTION

CAUTION indicates a potentially hazardous situation which, if not avoided, **MAY** result in minor or moderate injury. It may also be used to alert against unsafe practices or property damage.

CAUTION

CAUTION used without the safety alert symbol indicates a potentially hazardous situation which, if not avoided, **MAY** result in property damage

MODEL NUMBER: This number appears on sales literature, technical manuals and price lists.

SERIAL NUMBER: This number appears only on your mower. It contains the model number followed consecutively by the serial number. Use this number when ordering parts or seeking warranty information.

Serial Number Tag is located under seat; on the far back wall of the frame; left of battery from operators point of view.

Operator preparation and training

Read the Operation & Safety Manual

- If an operator or mechanic cannot read English, it is the owner's responsibility to explain this material to them. If any portion of this material is unclear, contact your factory representative for clarification.
- Become familiar with the safe operation of the equipment, operator controls and safety signs. Know how to stop the engine and attachments quickly in an emergency. Do not operate or allow another person to operate this machine if there are any questions about safety.
- All operators and mechanics should be trained. The owner is responsible for training the users.
- Wear appropriate clothing, including long trousers and safety goggles or safety glasses with side shields when operating mower. Do not operate barefoot or wearing open sandals. Long hair, loose clothing or jewelry may get tangled in moving parts.
- Wear hearing protection.
- Never allow underage children, unskilled or improperly trained people operate this equipment. Local regulations can restrict the age of the operator.
- Data indicates that those operators age 60 years and above are involved in a large percentage of riding mower-related injuries. Those operators should evaluate their ability to operate the riding mower safely enough to protect themselves and others from injury.
- Do not carry passengers, especially small children. They may fall off and be seriously injured.
- Keep warning labels and this operator's manual legible and intact. Replacement labels and manuals are available from the factory.
- Do not operate machine while under the influence of drugs or alcohol.
- The owner/user can prevent and is responsible for accidents or injuries occurring to themselves, other people or property.



Site preparation and circumstances

- Evaluate the terrain to determine what accessories and attachments are needed to properly and safely perform the job. Only use accessories and attachments approved by the manufacturer.
- Clear the area to be mowed of objects such as rocks, toys, wire or other debris that may be picked up or thrown by the mower.
- Be sure the area is clear of pets and people, especially young children. Never assume they will remain where you last saw them. Stop the machine if any enter the area.
- Mow only in daylight or in good artificial light.
- Do not mow wet grass as tires may lose traction.

SAFETY

Machine preparation

- Check operator presence interlock system and brake operation. Adjust or repair any problems before using.
- Do not tamper with or defeat safety devices. Keep guards, shields and interlock safety devices in place and in proper working condition. They are for your protection.
- Keep all fasteners such as nuts, bolts and pins well secured.
- Visually inspect blades, blade bolts and the cutter assembly for wear or damage. Replace worn or damaged blades and bolts to preserve balance.
- Verify that machine and attachments, if any, are in good operating condition.
- Do not engage blades until ready to mow.

In general

- Use extra care when loading or unloading the machine into a trailer or truck.
- Slow down and use caution when making turns and crossing roads and sidewalks. Stop blades if not mowing.
- Do not run the engine in an enclosed area where dangerous carbon monoxide fumes can collect.
- Do not place your foot on the ground while operating the machine.
- Before operating, lower the discharge chute, install the mulcher or put the entire grass catcher in place.
- Keep clear of the discharge opening at all times. Never direct the discharge toward a bystander. Stop operation if someone approaches.
- Keep washout ports and other mower housing service openings closed when mowing.
- Use care when pulling loads or using heavy equipment.
 - Use only approved draw bar hitch points.
 - Limit loads to those you can safely control.
 - Do not turn sharply. Use care when reversing.
 - Use counter-weight(s) or wheel weights when suggested in the operator's manual.
- Never leave a machine unattended. Always turn off blades, set parking brake, stop engine and remove key before dismounting.

Starting

- Start only according to instructions in this manual or on the machine.
- Before attempting to start the engine, make sure:
 - the parking brake is on;
 - the PTO is disengaged;
 - the traction drive is in NEUTRAL.
- When starting the engine, make sure hands and feet are clear of the blades.
- Do not start the machine while standing in front of the discharge chute or with the chute directed at someone.
- Do not engage PTO at full throttle. Throttle to idle or lowest possible engine speed.
- Do not change engine governor settings or over-speed the engine. Operating the engine at excessive speed can increase the hazard of personal injury.

Interrupting operation

- Before leaving the operator's position:
 - Park on level ground.
 - Disengage the PTO.
 - Set the parking brake.
 - Shut off the engine and remove the key.
- Disengage the PTO and wait until the blades quit rotating:
 - before raising cutterdeck;
 - when not mowing;
 - for transport;
 - when crossing surfaces other than grass.
- Stop the engine, disengage the PTO, set parking brake and wait until the blades quit rotating and lower cutting unit:
 - before refueling;
 - before removing grass catcher;
 - before making height adjustment unless the adjustment can be made from the operator's position.
- Stop the engine, disengage the PTO, set parking brake and disconnect the spark plug wire(s) or remove the key:
 - before clearing blockages or unclogging chute;
 - before checking, cleaning or working on the machine;
 - after striking a foreign object. Inspect the machine for damage and make repairs before restarting;
 - if the machine begins to vibrate abnormally: shut off machine immediately. Inspect and make repairs as needed before restarting;
 - except for repairs or adjustments as specifically noted, such as for carburetor adjustment, where the engine must be running. Keep hands and feet clear of moving parts in these circumstances.
- Allow the blades to come to a complete stop when stopping operation to clear blockages, unclog, inspect the machine, do maintenance or repair.
- Reduce the throttle setting during engine shut-down and, if the engine is provided with a shut-off valve, turn the fuel off at the conclusion of mowing.

In general

- Slow down before turning.
- Do not mow in reverse unless absolutely necessary. Always look behind and down for small children and pets before and during backing.
- Be aware when approaching blind corners, shrubs, trees, tall grass or other objects that may obscure vision.
- If tires lose traction, disengage the blades. If on a slope, head downhill.

Mowing slopes

Slopes are a major factor in loss-of-control and tip over accidents that sometimes lead to severe injury or death. All slopes require extra caution.



- Do not mow on slopes if uneasy or uncertain. Ultimate responsibility for safe operation on slopes rests with the operator.
- Do not mow excessively steep slopes. A slope is too steep if:
 - The machine will not back up the slope.
 - The machine must be crabbed (turned partially sideways uphill) to drive across the slope.
 - The machine turns downhill going across slope.
 - You are uneasy about being on the slope.
- On zero turn machines, mow across slopes, not up and down.
- Avoid starting or stopping on a slope. If tires lose traction, disengage the blades and proceed slowly straight down the slope.
- With a zero turn machine, if tires lose traction going down a slope, steering control may be regained by speeding up.
- Mid-mount zero turns (belly mounted deck) have much greater traction pointed up slope than down slope. Be aware that traction may be lost going down a slope. Do not operate a mid-mount zero turn on slopes it cannot back up.
- Keep all movement on the slopes slow and gradual. Do not make sudden changes in speed or direction.
- Do not turn on slopes unless necessary, and then turn slowly and downhill when possible.
- Stay away from slopes if the ground is loose or if caught in the rain during mowing.
- Use lower speeds on a slope to avoid stopping or shifting.
- Use extra care with grass catchers or other attachments. These can change the stability of the machine.
- Remove obstacles such as rocks, tree limbs etc.
- Avoid driving over obstacles such as ruts, holes, rocks and roots whenever possible. Be alert to dips and rises. Uneven terrain can overturn a mower or cause it to slide. Tall grasses can hide obstacles.
- Do not mow drop-offs, ditches or embankments. The machine could suddenly turn over if a wheel runs over the edge or an edge caves in.
- Follow the manufacturer's recommendations for wheel weights or counterweights to improve stability.
- Do not mow slopes when grass is wet. Reduced traction could cause sliding.

In general

- Maintain machine according to manufacturer's schedule and instructions for maximum safety and best mowing results.
- Park machine on level ground.
- Never allow untrained personnel to service machine.
- Adjust or repair only after the engine has been stopped and the blades have quit rotating.
- Inspect grass catcher components regularly. If worn, damaged or deteriorated, they may expose moving parts or allow objects to be thrown.
- Replace parts if worn, damaged or faulty. For best results, always replace with parts recommended by the manufacturer.
- Disconnect battery or remove spark plug wire(s) before making any repairs. Disconnect the negative terminal first and the positive last. Reconnect positive first and negative last.
- Do not dismantle the machine without releasing or restraining forces which may cause parts to move suddenly.
- Provide adequate support, e.g. jackstands for lifted machine or parts if working beneath.
- Do not put hands or feet near or under rotating parts.
- Clean up spilled oil or fuel thoroughly.
- Replace faulty mufflers.
- To reduce fire hazards, keep the engine, muffler, battery compartment and fuel storage area free of grass, leaves, debris buildup or grease.
- Hydraulic fluid can penetrate skin, use paper to check for leaks. Relieve hydraulic pressure before disconnecting hoses. Make sure connections are tight and hoses are in good condition.

Blades

- Mower blades are sharp and can cut. Use extra caution when handling. Remove obstructions with care. Wrap the blade(s) or wear gloves.
- Be aware that rotating one blade on multi-blade mowers can cause other blades to rotate.
- Only replace blades. Never straighten or weld them.
- Keep other persons away from blades.



Fuel

- Gasoline and diesel fuels are flammable; gasoline vapors are explosive. Use extra care when handling.
- Store only in containers specifically designed for fuel.
- When refueling or checking fuel level:
 - Stop the engine and allow to cool;
 - Do not smoke;
 - Refuel outdoors only;
 - Use a funnel;
 - Do not overfill;
 - If fuel is spilled, do not attempt to start the engine until the spill is cleaned up and vapors have cleared.
- Do not fill containers in a vehicle or on a truck or trailer bed with a plastic liner. Fill containers on the ground away from the vehicle.
- When practical, remove gas powered equipment from the truck or trailer and refuel it on the ground. If equipment must be refueled on the truck or trailer, refuel from a portable container rather than a dispenser nozzle.

Keep the dispenser nozzle in contact with the rim of the fuel tank or container opening until fueling is complete. Do not use a nozzle lock-open device.
- Replace caps on fuel cans and tanks securely.



SAFETY

BATTERY

Battery acid is caustic and fumes are explosive and can cause serious injury or death.

To reduce the risk of personal injury when working near a battery:

- When working with battery acid, use protective equipment such as, but not limited to, goggles, face shield, rubber gloves and apron.
- Avoid leaning over a battery.
- Do not expose a battery to open flames or sparks.
- Be sure batteries with filler caps are properly filled with fluid.
- Do not allow battery acid to contact eyes or skin. Flush any contacted area with water immediately and get medical help.
- Charge batteries in an open, well ventilated area, away from sparks and flames. Unplug charger before connecting or disconnecting from battery.

 **WARNING**

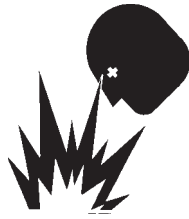

-
- Stop the engine and allow to cool before storing.
 - Drain the fuel tank outdoors only.
 - Store fuel in an approved container in a cool, dry place.
 - Keep the machine and fuel containers in a locked storage place to prevent tampering and to keep children from playing with them.
 - When the machine is to be parked, stored or left unattended, lower the cutterdeck unless a positive mechanical lock is used.
 - Do not store the machine or fuel container near heating appliances with an open flame such as a water heater or an appliance with a pilot light.
 - Keep gasoline storage area free of grass, leaves and excessive grease to reduce fire hazard.
 - Clean grass and debris from cutting units, drives, mufflers and engine to help prevent fires.

1. Be sure the jumper cables are in good condition. Turn off the ignition and all electrical accessories on both machines.
2. Position the machine with a good (charged) battery next to but not touching the machine with the dead battery so jumper cables will reach.
3. When making cable connections:
 - make sure the clamps do not touch anywhere except to intended metal parts,
 - Never connect a positive ("+" or red) terminal to a negative ("- " or black) terminal.
 - Make sure the cables won't get caught in any parts after the engines are started.
4. Connect one end of the first jumper cable to the **positive** terminal on one battery. Connect the other end to the **positive** terminal on the other battery.
5. Connect one end of the other cable to the **negative** terminal of the machine with a good (charged) battery. Make the final connection on the engine of the machine to be started, away from the battery.
6. Start the vehicle with the good battery, then the machine with the discharged battery.
7. Remove the cables in the exact reverse order of installation. When removing each clamp, take care it does not touch any other metal parts while the other end remains attached.

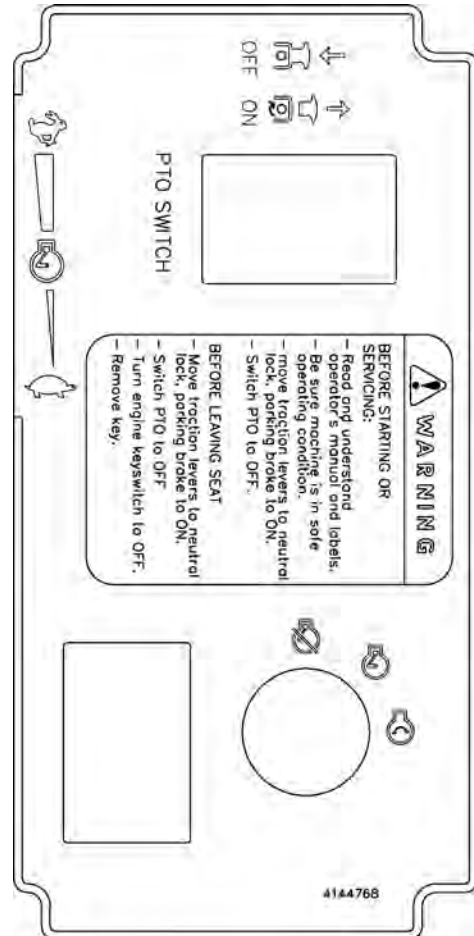
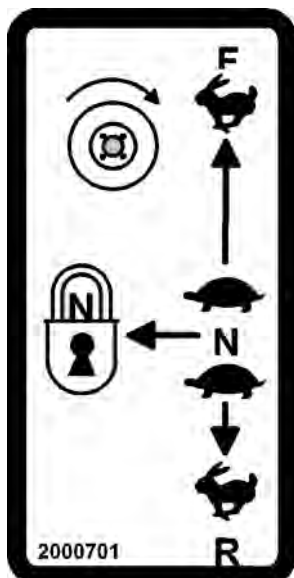
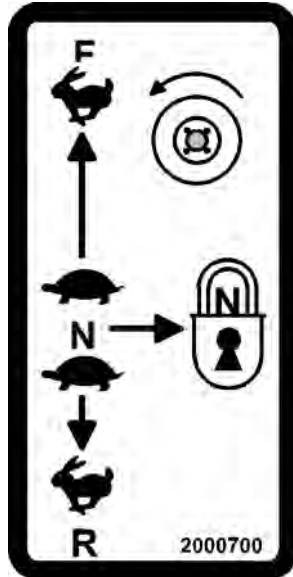

ADVERTENCIA

1. Leer el manual del operador. No permitir que personas no capacitadas para ello usen la máquina.
2. Mantener los protectores en su lugar y sus tornillos debidamente fijados.
3. Antes de limpiar, ajustar o reparar este equipo, apagar todos los mandos, aplicar el freno de estacionamiento y apagar el motor.
4. Mantener las manos, los pies y la ropa alejados de las piezas en movimiento.
5. No conducir como pasajero ni llavar pasajeros en máquinas sin asiento para ello.
6. Mantener a las demás personas alejadas durante el funcionamiento de la máquina.
7. Si no sabe leer inglés, solicitarle a otra persona que le lea y explique el contenido de las etiquetas y del manual de la máquina.

340830

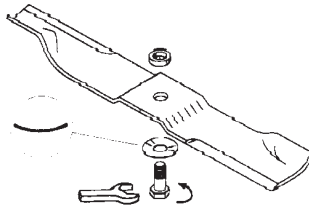

BLADE INSTALLATION

- Belleville washer must be positioned as shown.
- Torque blade bolt to 70 ft-lbs.
- See operator's manual for detailed blade changing procedure.

2000696

WARNING



- ROTATING PARTS.
- DO NOT OPERATE WITH COVER REMOVED.

2000577

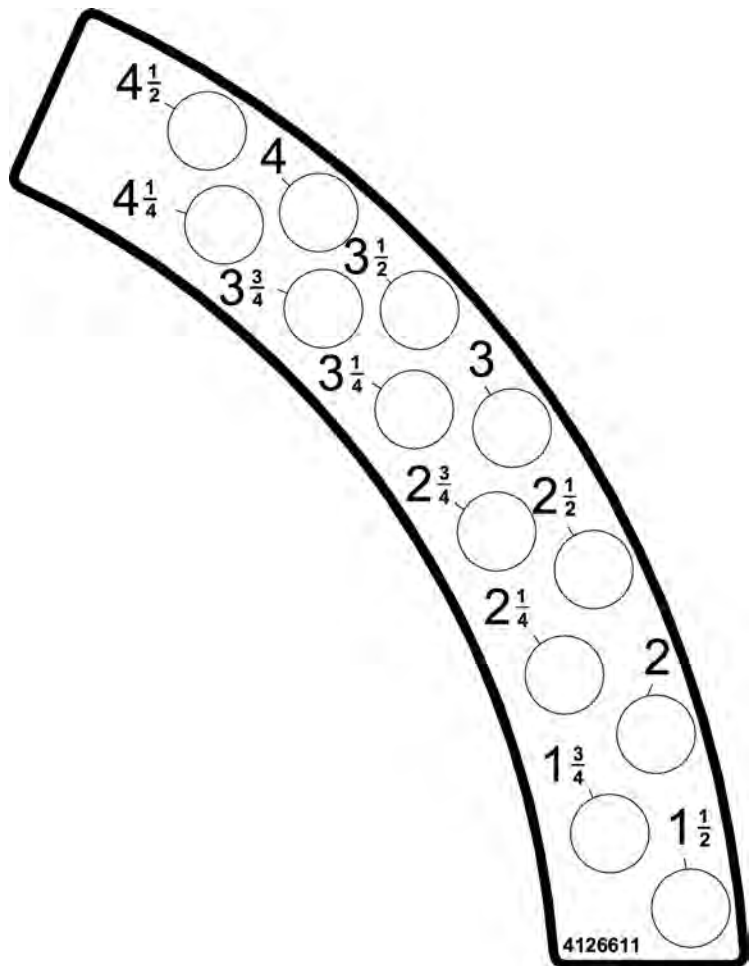
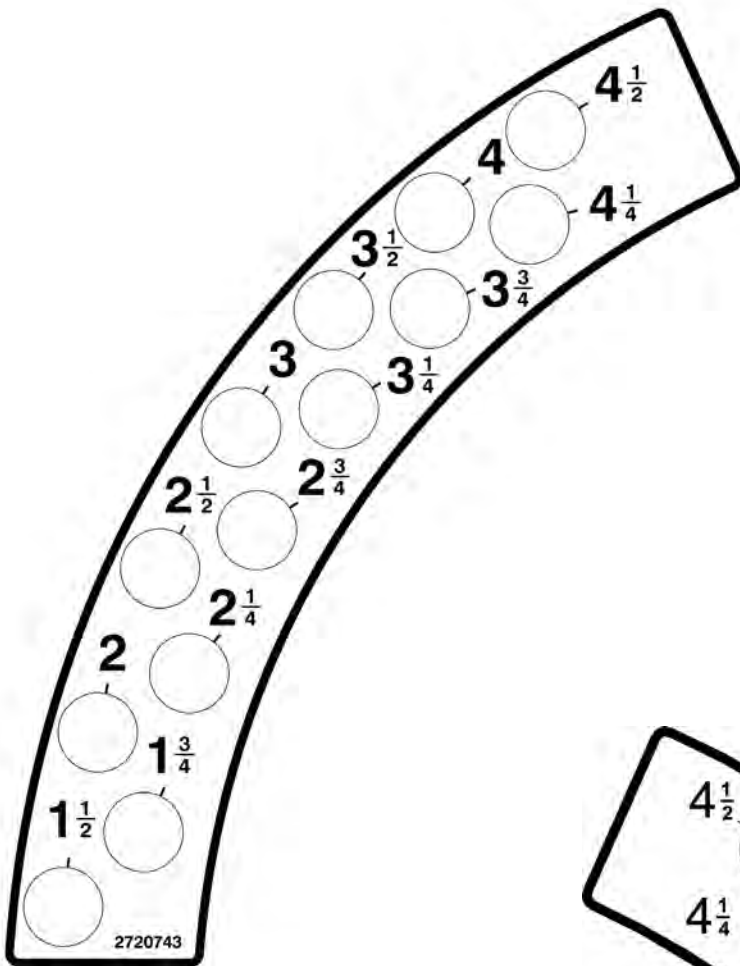

LABELS

⚠ WARNING ⚠

- REMOVE DEBRIS BUILDUP. DEBRIS UNDER BELT COVER OR NEAR MUFFLER CAN CAUSE FIRES.
- BLADES CONTINUE TO ROTATE FOR A FEW SECONDS AFTER BLADES ARE TURNED OFF.
- BLADES MUST BE AT LEAST 1/8" ABOVE BOTTOM OF HOUSING.
- ALL BLADES MUST BE IDENTICAL. CHECK BLADE BOLTS DAILY FOR TIGHTNESS.
- INSPECT FOR DAMAGE AFTER STRIKING A FOREIGN OBJECT. MAKE REPAIRS BEFORE RESTARTING OPERATION.
- FIND AND REPAIR CAUSE OF ANY ABNORMAL VIBRATION.

2000572

 **⚠ WARNING**

SPARKS OR FLAME CAN START EXPLOSION. DISCONNECT (-)NEGATIVE TERMINAL FIRST. RECONNECT (-)NEGATIVE TERMINAL LAST.

2000590

⚠ WARNING



TO CHECK OR ADD FUEL:

- Do it outdoors.
- Stop engine. Allow to cool.
- Do not smoke.
- Clean up spilled fuel.
- Do not overfill.
- Fill to one inch below bottom of filler neck.

2000570

⚠ WARNING

1. Do not mow up and down slopes. Mow across slopes.
2. Do not turn on slopes unless necessary, and then turn slowly and downhill when possible.
3. Do not mow slopes on wet grass. Reduced traction could cause sliding.
4. Do not mow drop offs, ditches, or embankments. Mower could suddenly turn over if a wheel runs over the edge or an edge caves in.

⚠ ADVERTENCIA

1. No cortar la hierba hacia arriba ni hacia abajo de una cuesta. Corte a traves de la cuesta.
2. No de la vuelta en la cuesta a no ser que sea necesario, de la vuelta despacio y baje lentamente.
3. No corte cuesta en hierba mojada. Las ruedas podrían deslizarse.
4. No corte al borde, de un barranco, hoyo profundo o terrenos irregulares. La maquina pudiera volcarse si las ruedas sobrepasan el borde del barranco o si el terreno irregular se hundiese.



4136953

⚠ WARNING

AVOID SERIOUS INJURY OR DEATH:

- Read and obey the Operation & Safety Manual.
- Remove objects that could be thrown by the blades.
- Do not mow when children or others are around.
- Do not carry a child or passenger, even with blades off.
- Look down and behind before and while backing.
- Do not operate unless trained.
- Do not operate unless guards, shields and interlocks are in place and working.
- Replace labels and Operation & Safety Manual if lost or damaged.

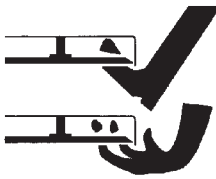
4136954

	<p>⚠ DANGER</p> <p>ROTATING BLADES</p> <ul style="list-style-type: none"> • KEEP HANDS AND FEET AWAY. • STOP ENGINE AND LET BLADES STOP BEFORE REMOVING GRASS COLLECTOR OR UNCLOGGING 		<p>⚠ WARNING</p> <p>THROWN OBJECTS</p> <ul style="list-style-type: none"> • KEEP AREA CLEAR OF PEOPLE AND PETS. • REMOVE OBJECTS BLADE MAY STRIKE AND THROW. • STOP BLADES TO CROSS GRAVEL AREAS • DO NOT OPERATE WITHOUT CHUTE, MULCHER OR ENTIRE GRASS COLLECTOR IN PLACE. <p>2000677</p>
---	---	--	---



Operator's Manual is located under the seat. 4146936

Tire Pressure

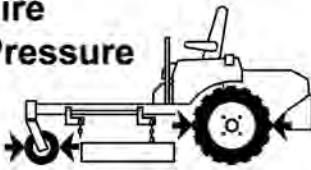

14 lbs/in² (1 kg/cm²)

4126802

(P) OFF

↓ ↑

ON **(P)**

PARKING BRAKE 4126804

CONTROLS

KEYSWITCH (K) - The keyswitch has three positions: **OFF**, **RUN**, and **START**. Insert the key and turn it clockwise to move the switch from **OFF** to **RUN**. Turn it further to **START** and hold to engage the starter. Release the key and the switch will return to **RUN** from **START**. Turn the key counterclockwise to **OFF** to stop the engine.

THROTTLE (T) - Move the throttle lever forward to increase engine speed until the maximum governed engine **RPM** is reached. Move the lever rearward to decrease engine speed until the engine reaches its idle speed.

CHOKE (C)

For Kawasaki and Briggs and Stratton Engines, pull the choke control out to set the choke **ON**. Push it in to set the choke **OFF**.

POWER TAKE OFF (PTO) SWITCH (P) -

The operator must be in the seat when engaging the **PTO** or the engine will kill. Pulling the **PTO** switch out engages (turns on) the **PTO** and starts the blades or other attachment. Pushing the **PTO** switch in disengages (turns off) the **PTO** and stops the blades or other attachment.

NOTE: The **PTO** switch does not control attachments powered by a separate engine.

- Disengage the **PTO** whenever you stop or leave the operator's position
- Shut off engine with the key and remove the spark plug wires before making adjustments or unplugging a clogged mower.
- Do not engage the **PTO** until ready to start mowing.

12 VOLT POWER OUTLET (X)

A 12 volt power outlet is provided to operate 12 volt personal accessories.

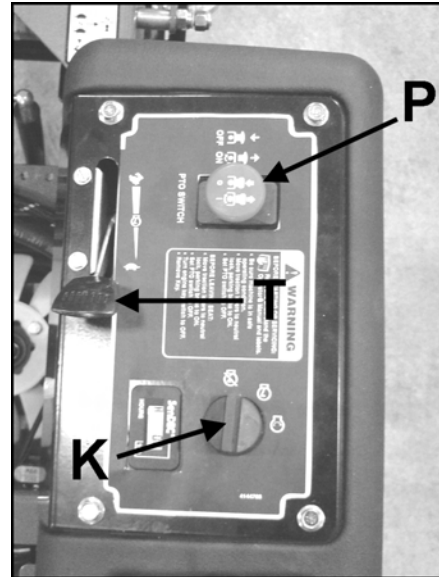

At operator's right side

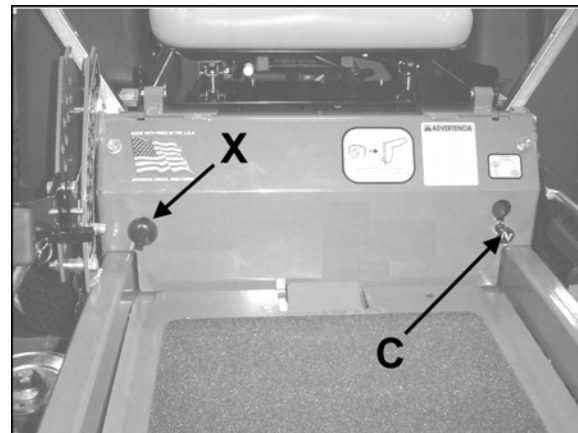

Below seat

FUEL SELECTOR VALVE (U)

The fuel tank selector valve is located behind the seat.

The fuel tank selector valve has three positions:

Off: The tank selector is off when the lever points down. The selector should be off whenever the machine is transported or stands unused for any length of time. Shutting off the fuel supply avoids the possibility of flooding should any dirt get under the carburetor float needle. Leaving the tank selector in either tank position can allow severe flooding, which may ruin the engine by diluting the oil.

Right Tank: Fuel flows from the right tank when the selector is turned 1/4 turn toward the right.

Left Tank: Fuel flows from the left tank when the selector is turned 1/4 turn toward the left.

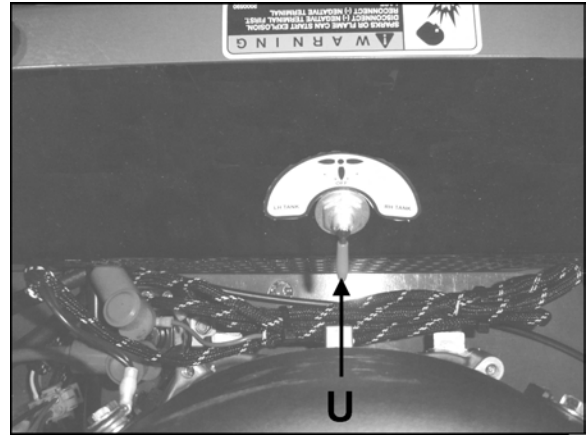

CONTROLS

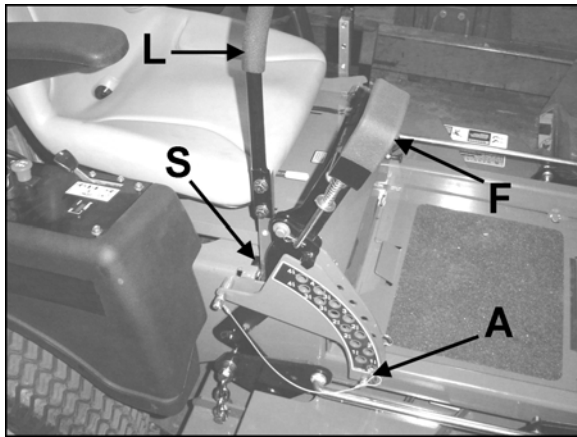

**Lift and traction levers
(operator's right side)**

LIFT LEVER (F) - Used to raise the cutterdeck to maximum height for transport, curb climbing or blade changing. To return to preset height of cut, lower lift lever until it contacts height of cut pin **A**.

TRACTION LEVERS (L) - Each of the two traction levers controls the drive wheel located on the same side. They control the forward and reverse movement of the machine, provide steering and also provide dynamic braking.

The operator must be in the seat and the parking brake must be **OFF** to engage the traction drive. To engage traction drive, move the traction levers toward the center of the machine until they are out of neutral lock slot **S**.

Forward movement - To move the machine straight ahead, push both traction levers forward equally from their neutral position. Forward speed increases as the levers are moved farther forward from the neutral position. Maximum forward speed is reached when the levers hit the front of the forward-reverse slot. When traveling forward, pulling the traction levers rearward slows the machine. The machine stops when the neutral position is reached.

Reverse movement - To move the machine straight back, pull both traction levers back equally from their neutral position. Reverse speed increases as the levers are moved back farther. Maximum reverse speed is reached when the levers hit the rear of the forward-reverse slot. When moving in reverse, pushing the levers forward slows the machine, and the machine stops when the neutral position is reached.

NOTE: Reverse is spring loaded to return to neutral. This spring resistance may be felt when moving the traction levers into reverse. When the levers are released in reverse, spring tension will slowly return them to the neutral position.

STEERING - To steer, move one lever forward and one back.

Turns during forward movement:

- **Right turn** - move the right traction lever back toward neutral to slow the right drive wheel.
- **Left turn** - move the left traction lever back toward neutral to slow the left drive wheel.

Turns during reverse movement:

- **Reverse right turn** - move the right traction lever forward toward neutral to slow the right drive wheel.
- **Reverse left turn** - move the left traction lever forward toward neutral to slow the left drive wheel.

Slow, sweeping turns are made with both traction levers on the same side of neutral and slightly apart. True zero radius turns about the center of the machine are made by having one lever in reverse while the other is in forward. By varying the relative positions of the two levers, the rate of turn is varied to suit the mowing situation.

CAUTION

Slow down before making sharp turns. The machine is capable of turning very rapidly when the levers are moved further apart from each other. Loss of control and/or turf damage may result.

PARKING BRAKE (R) - Pull the parking brake lever up and back to put the parking brake ON. Push it forward and down to put the parking brake OFF.

The parking brake must be ON to start the engine. It must also be ON to keep the engine running if the operator leaves the seat. The parking brake must be OFF to keep the engine running when a traction lever is moved out of neutral lock.

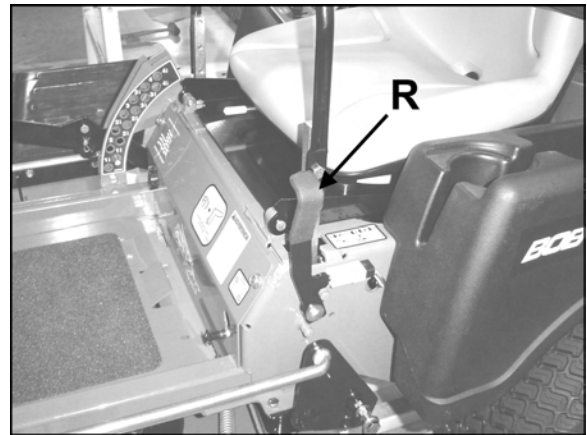

**Parking brake in ON position
(operator's left side)**

PUSHING THE MACHINE

The machine may be pushed with the engine off, the parking brake off, and the bypass valves open.

To open the bypass valves, move the parking brake to the **OFF** position, then lift and pull bypass control rod **C** through the large opening **D**, until the control rod stop is past the opening. Drop rod **C** into the small opening to lock in place. Repeat for the other bypass control rod.

To close the bypass valves, lift bypass control rod **C** allowing the control rod stop to retract through the large opening **D**.

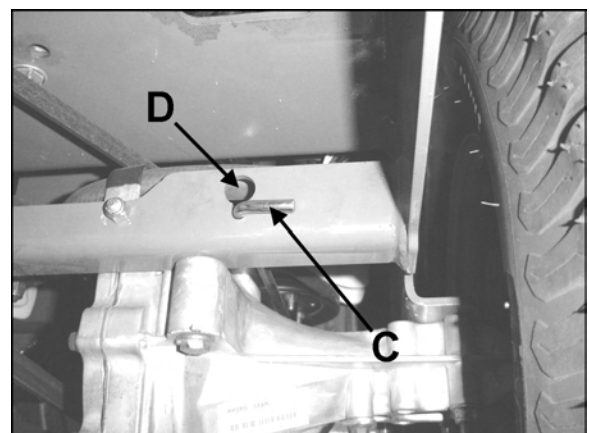
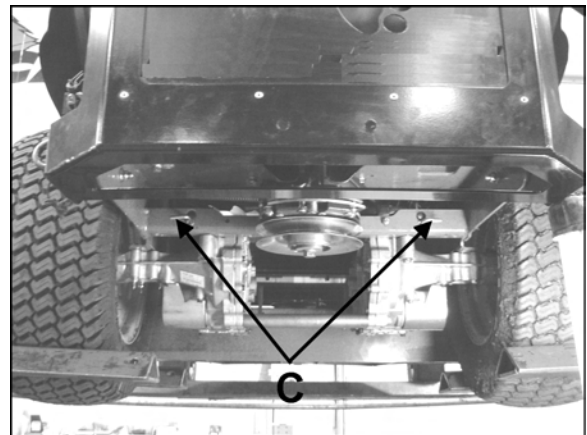

PRE-OPERATION CHECK LIST

PRE-OPERATION CHECK LIST (OPERATOR'S RESPONSIBILITY)

- | | |
|---|--|
| <ul style="list-style-type: none">___ Review and follow all safety rules and safety decal instructions.___ Check that all safety decals are installed and in good condition. Replace if damaged.___ Check to make sure all shields and guards are properly installed and in good condition. Be sure that either the discharge shield or complete vacuum attachment is installed.___ Check that all hardware is properly installed and secured.___ Check that equipment is properly and securely attached to power unit.___ Check to be sure engine is free of dirt and debris. Pay particular attention to the cooling fins, governor parts and muffler. Clean air intake screen. Check air cleaner; service if necessary. | <ul style="list-style-type: none">___ Never allow riders.___ Inspect area and remove stones, branches or other hard objects that might be thrown, causing injury or damage.___ Clean area around oil fill dipstick. Remove dipstick and check to be sure oil is in operating range (between marks on dipstick). Add oil if necessary but Do Not Overfill. Install dipstick assembly firmly until cap bottoms out on tube. Dipstick assembly must always be secured into fill tube when engine is running.___ Check all lubrication points and grease as instructed in manual.___ Check hydrostatic fluid level. Check to be sure cooling fins on hydrostat are clean.___ Perform a functional check of the safety interlock system each time you operate the unit. |
|---|--|

FUELING

- Fill fuel tank with good quality, clean, unleaded regular gasoline. Do not use hi-test fuel.
- Use a funnel to avoid spilling.

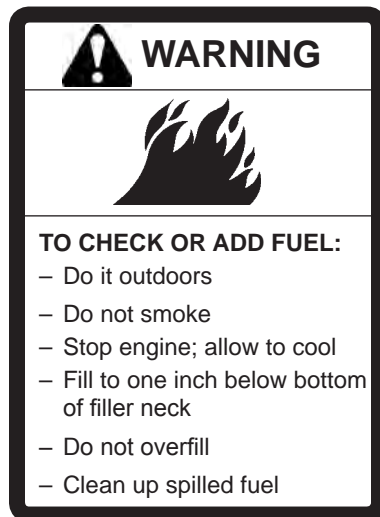

BEFORE STARTING THE ENGINE

- Be familiar with all controls, how each functions and what each operates.
- Check the engine oil level and add if necessary. Using the fuel selector valve, select which tank will supply fuel
- **Choke:** For cold starts, set the throttle lever to the half-open position and pull the choke out to the ON position. For warm starts set the throttle to the half-open position and the choke to the OFF position.

OPERATOR PRESENCE INTERLOCK SYSTEM

To start the engine:

- The PTO switch must be **OFF**.
- Both traction levers must be in the neutral lock position.
- The parking brake must be **ON**.

To operate the machine:

1. The operator must be in the seat or engaging the PTO will kill the engine.
2. The parking brake must be **OFF** and the operator must be in the seat, or moving a traction lever from the neutral lock position will kill the engine.

STARTING THE ENGINE

1. Turn the key to operate the electric starter to start the engine. Release the key when the engine starts.
2. If the engine does not start immediately, do not crank for more than 10 seconds at a time. Allow 60 seconds for the starter motor to cool down between starting attempts to prevent the starter motor from burning out.
3. If the choke is ON when the engine starts, gradually back it off until the engine runs with no choke at all.

OPERATING NOTES

- Practice at slow engine and travel speeds with the PTO off until fully familiar with the controls.
- For normal cutting the throttle should be set at the full open position. By using the traction levers to speed up or slow down the machine during use, maximum control and cutting efficiency can be maintained.
- Using the machine at less than full throttle in heavy conditions will cause the engine to labor and result in excessive wear.

DRIVING

1. With the PTO disengaged, move the parking brake to OFF.
2. Move both traction levers out of neutral lock.
3. Push both traction levers forward evenly to drive forward in a straight line. Pull both traction levers back evenly to drive backward in a straight line.
4. **Steering** - Move one lever forward and one back.

Turns during forward movement:

- **Right turn** - move the right traction lever back toward neutral to slow the right drive wheel.
- **Left turn** - move the left traction lever back toward neutral to slow the left drive wheel.

Turns during reverse movement:

- **Reverse right turn** - move the right traction lever forward toward neutral to slow the right drive wheel.
- **Reverse left turn** - move the left traction lever forward toward neutral to slow the left drive wheel.

CAUTION

Use caution when making turns. Slow down before making sharp turns to help maintain control and to prevent torn turf from skidding or spinning tires. To help prevent turf damage, keep both drive tires moving whenever a turn is made.



TIP: The best way to make a sharp "zero" turn is to come to a stop, get the machine moving in reverse with both drive wheels and then power the machine around with the outside wheel. This technique keeps the drive tires turning and results in less turf damage.

CUTTING

1. Place the discharge chute in the down position or correctly fit a grass collector or mulcher plate.
2. Sit in the seat.
3. Start the engine.
4. Turn the blades on by pulling up on the PTO switch. Do not start the blades at full throttle. Instead, use the slowest throttle setting that will allow the engine to pick up the blade load to reduce the wear on the belts and electric clutch.
5. After the blades are rotating, set the throttle to maximum. Use the traction levers to obtain the required cutting speed, to steer around obstacles and to turn at the end of a cut.

CUTTING TIPS

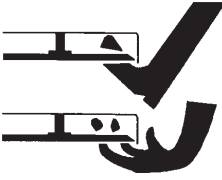
- When mowing large areas, start by turning to the right so that clippings will be discharged away from shrubs, fences, driveways, etc. After two or three rounds, mow in the opposite direction, left hand turns, until finished.
- If grass is extremely tall, it should be mowed twice, the first cut relatively high, the second cut to the desired height.
- Use the left side of the mower for trimming.
- Choose cutting directions so that clippings are thrown onto areas that already have been cut. This method results in the most even distribution of clippings and more uniform, better appearing cuts.
- Use a different mowing pattern each time where possible. This helps prevent rutting and leads to a more uniform cut by keeping the grass from always laying the same way.

	 DANGER
	ROTATING BLADES <ul style="list-style-type: none"> - KEEP HANDS AND FEET AWAY. - STOP ENGINE AND LET BLADES STOP BEFORE REMOVING GRASS COLLECTOR OR UNCLOGGING.

	 WARNING
	THROWN OBJECTS <ul style="list-style-type: none"> - KEEP AREA CLEAR OF PEOPLE AND PETS. - REMOVE OBJECTS BLADE MAY STRIKE AND THROW. - STOP BLADES TO CROSS GRAVEL AREAS - DO NOT OPERATE WITHOUT CHUTE, MULCHER OR ENTIRE GRASS CATCHER IN PLACE.

MAINTENANCE CHART

MAINTENANCE OPERATION	Maintenance is an ongoing job. These intervals are maximum times between maintenance operations. Perform more often under severe conditions.						
	FIRST 5 HOURS	BEFORE EACH USE	EVERY 25 HOURS	EVERY 50 HOURS	EVERY 100 HOURS	EVERY 200 HOURS	YEARLY
ENGINE							
Consult the engine manual for additional information and instructions							
Check/Top Up Oil Level		X					
Check For Leaks		X					
Clean Air Intake Screen		X					
Clean Air Cleaner Precleaner			X				
Clean Air Cleaner Element			X				
Clean Cooling Fins					X		
Change Oil	X			*X			X
Change Oil Filter	X				X		X
Check/Replace Spark Plugs						X	
TRANSAXLE							
Check Oil Level		X					
Check For Leaks		X					
Change Oil And Filter						X	
MACHINE							
Check Interlock Operation		X					
Check Tire Pressures		X					
Check Battery							X
Lubricate All Points *see page 25				X			X
Check Hardware		X					

*Change oil after first 5 to 8 hours of use, then every 50 hours. Change oil every 25 hours when operating the engine under heavy load or in high temperatures.

MAINTENANCE RECORD

GENERAL	DATE	HRS	DATE	HRS	DATE	HRS	DATE	HRS	DATE	HRS	DATE	HRS
Check Tire Pressures												
Lubricate All Points												
Check Nuts & Bolts												
ENGINE												
Check Oil Level												
Change Oil												
Clean Air Cleaner Element												
Clean Cooling Fins												
Replace Air Cleaner Element												
Clean & Gap Spark Plugs												
TRANSAXLE												
Change Oil And Filter												
NOTE: After first 5 hours of operation change engine oil and filter.												

Repair Protection Agreements

Congratulations on making a smart purchase. Your new Craftsman® Professional product is designed and manufactured for years of dependable operation. But like all products, it may require repair from time to time. That's when having a Repair Protection Agreement can save you money and aggravation.

Here's what the Repair Protection Agreement* includes:

- Expert Service** by our 10,000 professional repair specialists
- Unlimited service and no charge** for parts and labor on all covered repairs
- Product replacement** up to \$1500 if your covered product can't be fixed
- Discount of 10%** from regular price of service and related installed parts not covered by the agreement; also, 10% off regular price of preventative maintenance check
- Fast help by phone** - we call it Rapid Resolution - phone support from a Sears representative. Think of us as a "talking owner's manual."

Once you purchase the Repair Protection Agreement, a simple phone call is all that it takes for you to schedule service. You can call anytime day or night, or schedule a service appointment online.

The Repair Protection Agreement is a risk-free purchase. If you cancel for any reason during the product warranty period, we will provide a full refund. Or, a prorated refund anytime after the product warranty period expires. Purchase your Repair Protection Agreement today!

Some limitations and exclusions apply.

For prices and additional information in the U.S.A. call 1-800-827-6655

***Coverage in Canada varies on some items. Full full details call Sears Canada 1-800-361-6665**

Sears Installation Service

For Sears professional installation of home appliances, garage door openers, water heaters, and other major home items, in the U.S.A. or Canada call 1-800-4-MY-HOME®.

MAINTENANCE

CHECK DAILY

Operator Presence Interlock System - Start Operation

For the engine to crank, the parking brake must be on, the PTO (blades) off and traction levers in the neutral lock position. Sit in the seat and check, one by one, if the engine will crank with the parking brake off, the blades on, and either traction lever out of neutral lock.

Operator Presence Interlock System - Run Operation

The operator must be in the seat for the engine to run with the parking brake off, the traction levers moved out of the neutral lock position, or the blades on. To check:

1. Start the engine and run at 1/2 throttle with the operator on the machine but raised off the seat.
2. One by one: move the parking brake to the OFF position, traction levers out of the neutral lock position (check each independently), and turn the blades on. Each check should kill the engine after 1/2 second. (A 1/2 second delay is built into the system to prevent engine cutout when traversing rough terrain.)

Repair machine before using if the Operator Presence Interlock System does not operate correctly in start or run.

Hardware

Tighten any nuts and bolts found loose. Replace any broken or missing cotter pins. Repair any other problems before operating.

Tire pressure

Tires should be kept inflated to 14 lbs/in² (1.0 kg/cm²). Improper tire inflation can cause rapid tire wear and poor traction. Uneven inflation can cause uneven cutting. Overinflation of caster tires can cause casters to "wobble" on hard surfaces.

BATTERY

 **WARNING** Battery acid is caustic and fumes are explosive and can cause serious injury or death.

Use insulated tools, wear protective glasses or goggles and protective clothing when working with batteries. Read and obey the battery manufacturer's instructions.

Be certain the ignition switch is OFF and the key has been removed before servicing the battery.

1. Verify battery polarity before connecting or disconnecting the battery cables.
2. When installing the battery, always assemble the RED, positive (+) battery cable first and the BLACK ground, negative (-) cable last.
3. When removing the battery, always remove the BLACK ground, negative (-) cable first and the red, positive (+) cable last.

4. Check the electrolyte level every 100 hours of operation or yearly, whichever comes first. Top off with distilled water if necessary.

NOTE: Sealed batteries cannot be checked or topped off.

5. Clean the cable ends and battery posts with steel wool. Use a solution of baking soda and water to clean the battery. Do not allow the solution to enter into the battery cells.
6. Tighten cables securely to battery terminals and apply a light coat of silicone dielectric grease to terminals and cable ends to prevent corrosion. Keep terminal covers in place.

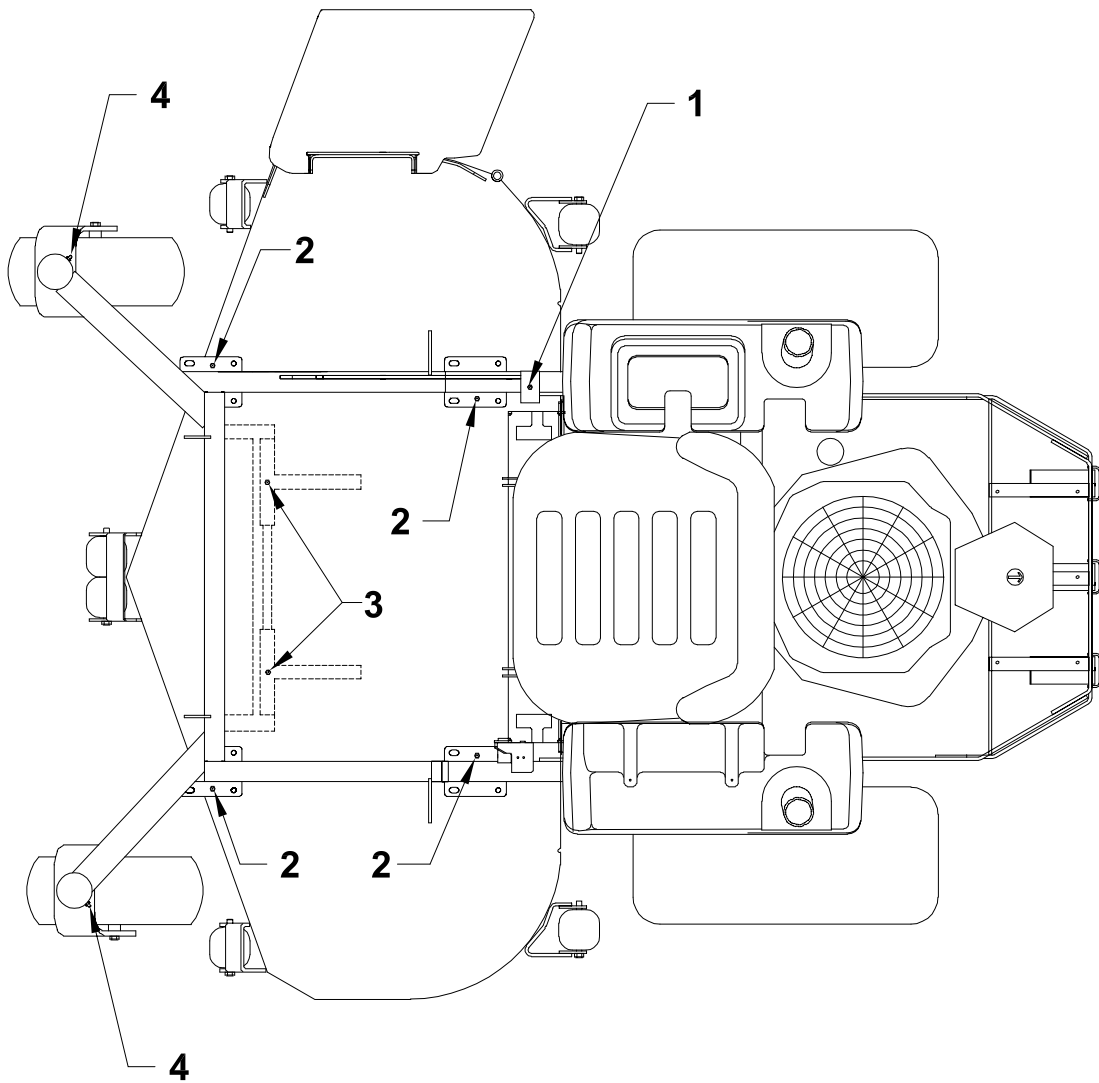

LUBRICATION

Every 50 hours of operation, lubricate the following points (1-3) with grease:

1. Deck lift lever (1 point)
2. Deck lift pivots (4 points)
3. Pull arms (2 points located at the front of the cutterdeck)
4. Caster wheel pivots (2 points)
(Lubricate every 500 hours or once a year)

NOTE ON BLADE SPINDLES - The blade spindles on these machines use a superior sealed bearing that does not require relubrication.

MAINTENANCE

ENGINE OIL

Perform engine maintenance with the engine off, spark plug wires disconnected and PTO disengaged.

AFTER FIRST FIVE (5) HOURS

While the engine is warm:

1. Remove drain cap at location **D** and drain the crankcase. Dispose of used oil in accordance with local requirements.
2. Clean and replace the cap.
3. Change oil filter.
4. Fill the crankcase with fresh oil to the full mark. Do not overfill. See engine manual for oil specifications.

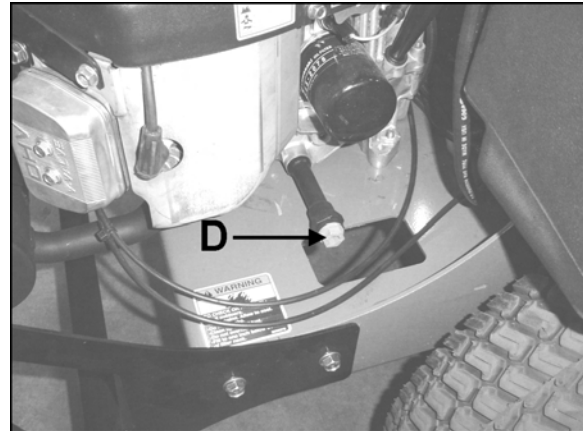

DAILY

1. Check oil level with the dipstick.
2. If oil is needed, add fresh oil of proper viscosity and grade. See engine manual for oil specifications. Do not overfill.
3. Replace dipstick before starting engine.

PERIODIC OIL CHANGES

1. See Page 22 maintenance chart for oil and filter change intervals after the break-in period.
2. Follow instructions for first oil change, above.

OIL CAPACITY

Engine without oil filter holds approximately 1-7/8 quarts (60 ounces; 1.8 liters).

Engine equipped with oil filter holds approximately 2 quarts (64 ounces; 1.9 liters).

Use a high quality detergent oil classified "For Service SF, SG, SH, SJ" or higher.

Use recommended SAE viscosity grade oil per starting temperature according to **Figure 1**.

Figure 1

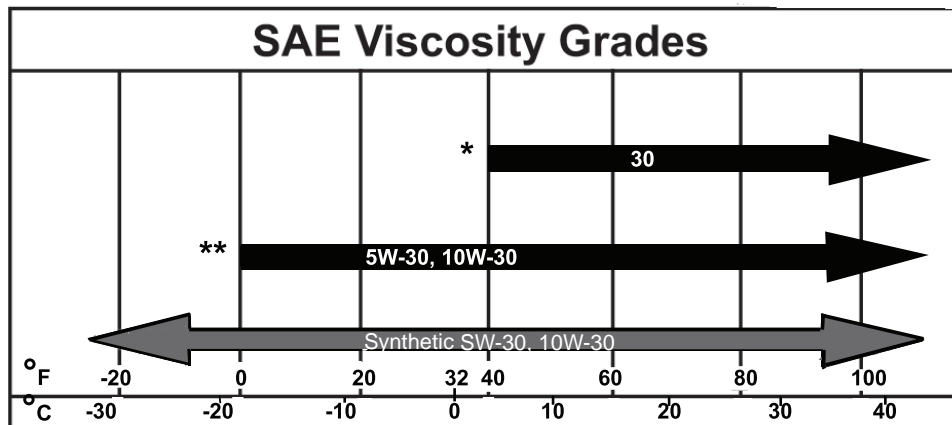

SPARK PLUGS

Remove each plug and check condition.

- Good operating conditions are indicated if the plug has a light coating of grey or tan deposit.
- A white blistered coating indicates overheating. A black coating indicates an "over rich" fuel mixture. Both may be caused by a clogged air cleaner or improper carburetor adjustment.
- Do not sandblast, wire brush or otherwise attempt to repair a plug in poor condition. Best results are obtained with a new plug.
- Set plug gap as specified in engine manual..

FUEL FILTER

An in-line fuel filter is located in the fuel supply line. Inspect at every oil change to make sure it is clean and unobstructed. Replace if dirty.

DUAL ELEMENT AIR CLEANER

Engines equipped with dual element air cleaners have a paper air cleaner element with an oiled, foam precleaner element on the dirty side of the paper element. Both should be inspected regularly and maintained.

Clean and re-oil precleaner element every 25 hours (more often under dusty conditions).

1. Disassemble air cleaner cover.
2. Remove precleaner.
3. Wash precleaner in kerosene or liquid detergent and water.
4. Wrap precleaner in cloth and squeeze to remove cleaner.
5. Saturate precleaner in engine oil. Squeeze to remove excess oil.
6. Re-install precleaner. Reassemble air cleaner components and screw assembly down tight.

Every 100 hours (more often under very dusty or dirty conditions), check the paper cartridge.

- Clean by tapping gently.
- Do not wash the cartridge or use compressed air which can cause damage.
- Replace when cartridge is dirty, bent or damaged.

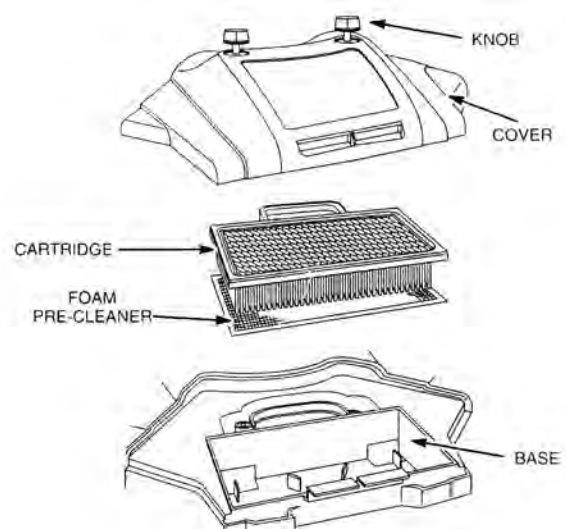
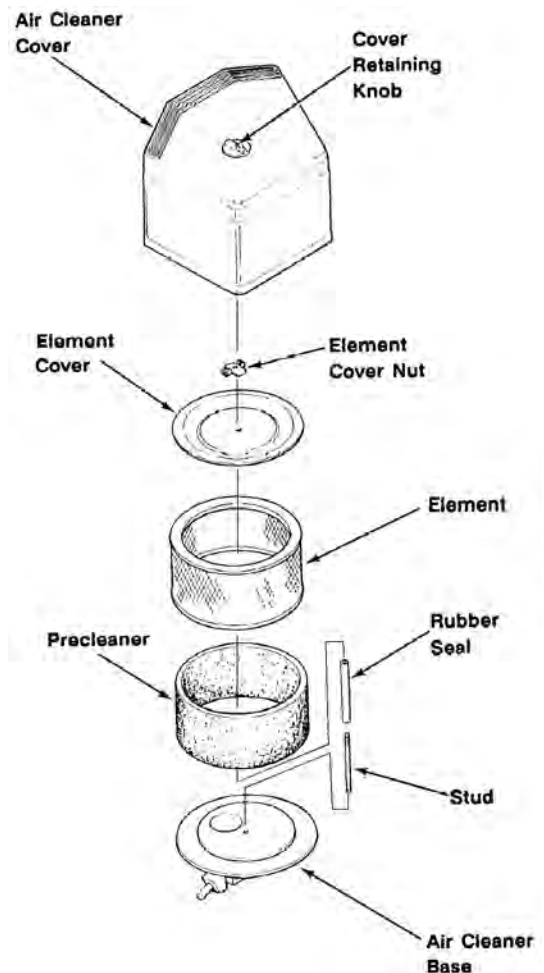

MAINTENANCE

ENGINE COOLING

Continued operation with a clogged cooling system will cause severe overheating and can result in engine damage.

- **Daily:** Clean air intake screen **V**.
- **Every 100 hours:** Clean cooling fins beneath blower housing **H** with reference to information in the engine manufacturer's manual.

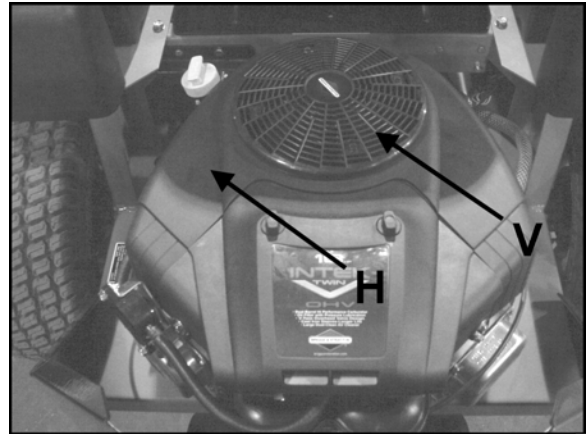

SPECIFIC TORQUES

BLADE BOLTS	70 FT-LBS (95 Nm)
WHEEL HUB NUTS	150 FT-LBS (203 Nm)
ENGINE CRANKSHAFT BOLT	50 FT-LBS (68 Nm)
TRANSAXLE PULLEY NUT	28.3 - 41.6 FT-LBS (38 - 56 Nm)
TRANSAXLE DRAIN PLUG	15 - 20 FT-LBS (20 - 27 Nm)
TRANSAXLE FILTER	130 - 150 in-lbs (14.6 - 16.9 Nm)

PURGING TRANSAXLES

Due to the effects air has on efficiency in hydrostatic drive applications, it is critical that it be purged from the system.

These purge procedures should be implemented any time a hydrostatic system has been opened to facilitate maintenance or any additional fluid has been added to the system.

Purging may be required if the unit shows any of the following symptoms:

- Noisy operation.
- Lack of power or drive after short term use.
- High operation temperature, excessive oil expansion.

1. Check the transaxle fluid, fill to proper level, if required.
2. Raise the drive wheels off the ground. Support unit with jackstands or other suitable means.
3. With the bypass valves open, and the engine running, slowly move the control levers in both forward and reverse directions 5 to 6 times. As air is purged from the unit, the oil level will drop.
4. With the bypass valve closed, and the engine running, slowly move the control levers in both forward and reverse directions 5 to 6 times.
5. Stop engine. Check the transaxle fluid level, add fluid as required.
6. It may be necessary to repeat steps 3-5 until all the air is completely purged from the system. When the transaxle moves forward and reverse at normal speed, purging is complete.

TRANSAXLES

⚠ WARNING

Inattention to proper safety, operation, or maintenance procedures could result in personal injury, or damage to the equipment. Sears recommends returning the machine to your authorized Sears Craftsman Professional for service or repair.

Perform transaxle maintenance with the engine off, spark plug wires disconnected and PTO disengaged.

TRANSAXLE FLUID CHANGE

Change the transaxle fluid every 200 hours of operation. It is essential that the exterior of the transaxle be free of debris, prior to fluid maintenance.

1. Remove the three 1/4" filter guard screws and filter guard **A**. Remove the oil filter **B** from the transaxle and discard. Dispose of used oil in accordance with local requirements.
2. Wipe the filter base surface off and apply a film of new oil to the gasket of the new replacement filter. Install the new filter by hand, turn 3/4 to one full turn after the filter gasket contacts the filter base surface.
3. Re-install the filter guard and torque the three screws to 65 in. lbs. each.
4. Remove cap **C**, fill the transaxles through the expansion tank **D** with approximately 4 quarts of SAE 20W-50 engine oil.

CAUTION

Do not overfill! If you overfill the transaxle while the unit is "cold", it may overflow as it reaches normal operating temperatures. The oil level should not be above the manufacturer's suggestions. This will allow the space needed for the oil to expand as it warms up.

5. After starting engine, check the fluid level and continue to add oil to overflow tank **D** to fill line on tank.
6. Purge the transaxles, following the purging procedures on Page 28.

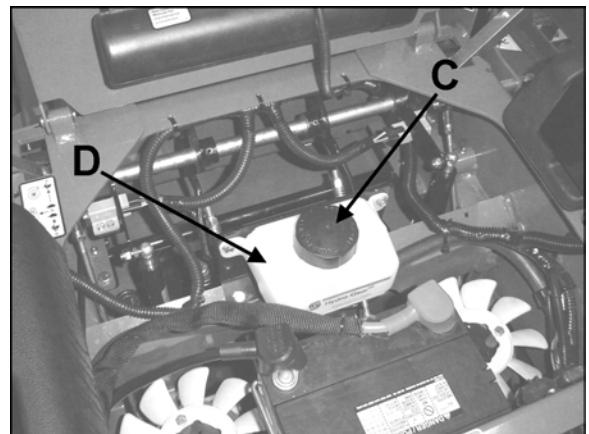
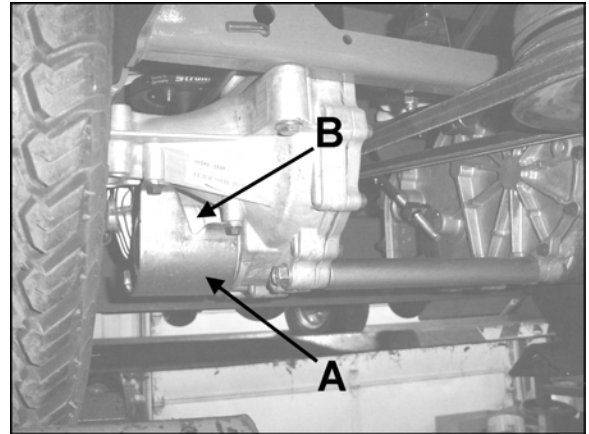

MAINTENANCE

BLADE REMOVAL

Follow these instructions to prevent injury during blade removal:

1. Loosen with a box wrench or a socket and long breaker bar. To gain additional leverage, slip a long pipe or thick-walled tube over breaker bar or wrench.
2. Insert wood block **A** as shown, with grain perpendicular to blade, to prevent blade from turning when loosening.
3. Wear thickly padded gloves. Keep hands clear of blade path. Blades may rotate when bolt releases.

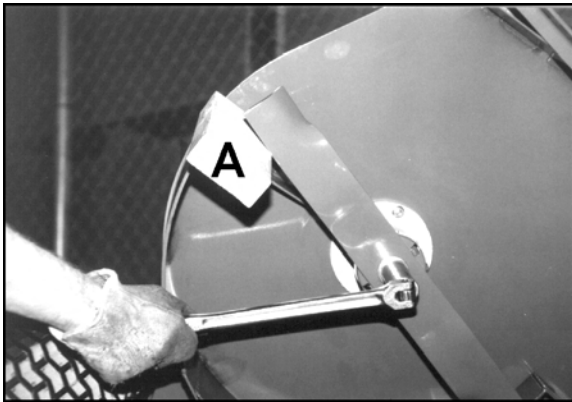

SHARPENING

Blades may be sharpened by filing or grinding.

- Inspect blades before sharpening.
- Replace bent or cracked blades.
- Replace blades when the lift portion has worn thin.
- Maintain cut angle at 30° .
- Do not overheat blades when sharpening.
- Always use Craftsman Professional blades. Use of another manufacturer's blades may be dangerous.

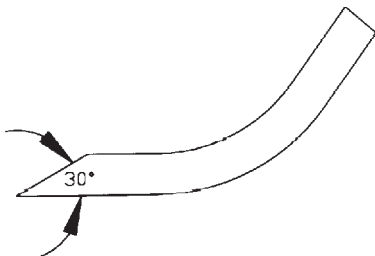

BLADE BALANCE

Blade balance must be maintained at 5/8 oz-in (19.4 g-cm) or less. Failure to keep blades balanced causes excess vibration, wear, and shortened life of most components of the machine.

To balance a blade:

1. Sharpen blade first.
2. Balance the blade at the center.
3. Attach a 1/8 oz (3.9 g) weight at a distance 5" (127 mm) from center on the light end. This should make the light end the heavy end:
 - If it does, the blade is balanced.
 - If does not, file or grind the heavy end until the addition of the weight makes the light end the heavy end.

BLADE INSTALLATION

1. Wear thickly padded gloves to prevent cuts from the sharp blade.
2. Insert the blade bolt, in order, through the conical washer (cup side toward the blade, as shown), the blade, and the blade spacer.
3. Install assembly on the blade spindle.
4. Torque the blade bolt to 70 ft-lbs.

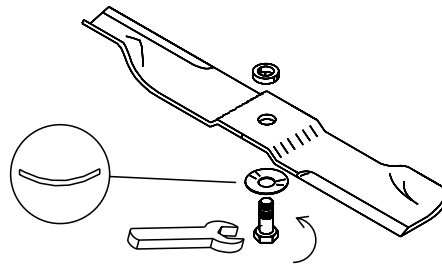

DECK LEVELING

1. Park the machine on a smooth, level surface. Raise the deck to the transport position.
2. Lower the deck onto a set of equal height blocks under the rear corners of the deck. Place another set of blocks under the front of the deck so that the deck top is pitched forward 1/8".

NOTE: The front and rear of the deck are at different heights.

3. Measure the height of the blade cutting edge above the ground. Remove pin **B** and set the height of cut lever **E** to that height.
4. Loosen nuts on bolts **G**. Move bolts in slot to remove slack in chain. Tighten nuts on bolts **G**.

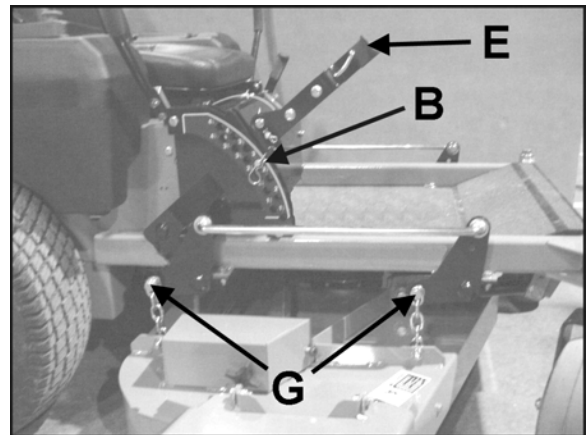

HEIGHT OF CUT

The height of cut is set by moving height of cut pin **B** to the hole designated for the height of cut desired.

To change the height of cut:

1. Lift the deck to the highest position.
2. Move pin **B** to the selected hole.
3. Lower the deck until the lift lever is stopped by the pin.

NOTES:

- Height of cut may vary due to the amount of tread on the tires, tire diameter or inflation pressure.

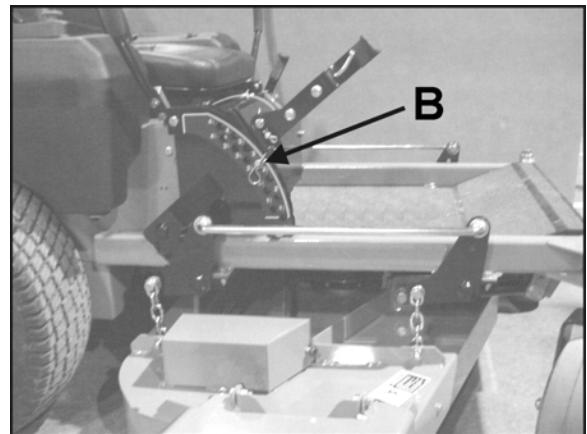

DECK ROLLERS

The deck rollers are adjustable up and down to provide improved deck flotation and scalping protection at various heights of cut. They are not intended to ride continuously on the ground. Adjust no closer than 3/8" (10mm) to the ground.

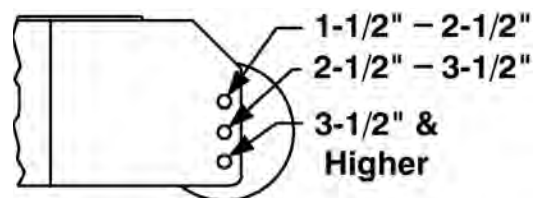

Height of cut ranges for roller adjustment

ADJUSTMENTS

PARKING BRAKE

NOTE: There are 2 brakes, 1 on each transaxle.

The parking brake should keep the machine from moving. To check the parking brake, park the machine on a level surface, open the bypass valves and set the parking brake to **ON**. Attempt to move the machine forward and backward by pushing it. If the machine moves, adjust the parking brake linkage as follows:

1. Move the machine to a flat horizontal surface.
2. Grip the flats on the brake rod **A**. Tighten nut **B** on the brake rod until you run out of threads. See Figure 1 for detailed view.
3. Move the parking brake handle to the **OFF** position.
4. Loosen nut **X**.
5. Hold brake arm in the **OFF** position as shown in Figure 2.
6. Adjust swivel **U** until swivel stud meets brake arm hole in the **OFF** position.
7. Insert cotter pin into swivel **U**.
8. Tighten nut **X**.
9. Repeat Steps 1-8 on the opposite side.

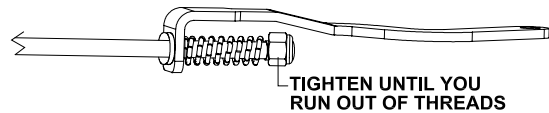
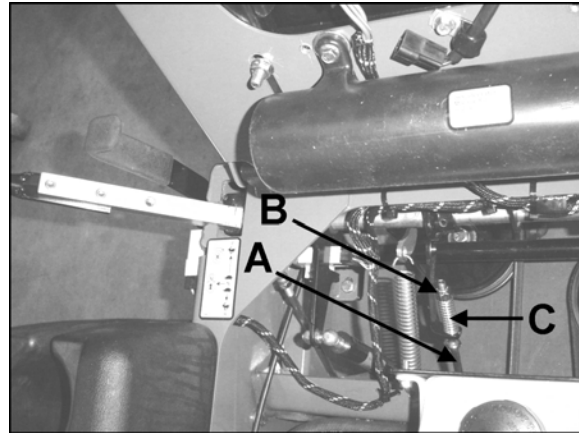

FIGURE 1

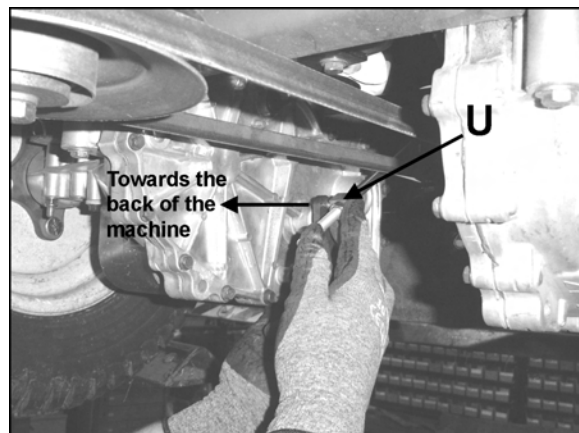
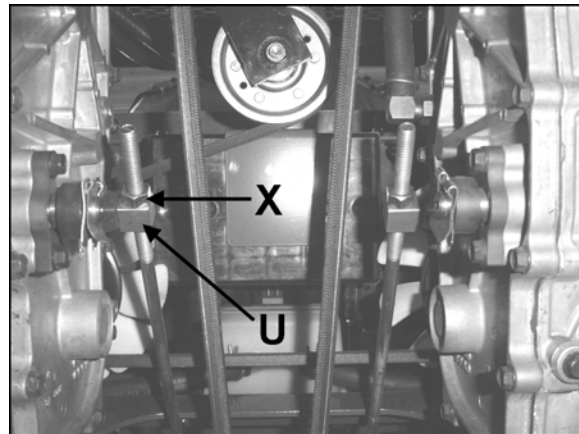

FIGURE 2

HYDROSTATIC TRANSAXLE ADJUSTMENTS

A turnbuckle style hydrostat neutral adjustment is provided.

Neutral:

1. Support the machine with the rear wheels off the ground. Use jackstands or equivalent support. Do not rely only on mechanical or hydraulic jacks.
2. Move the traction levers out into the neutral lock position and raise the seat.
3. Disconnect the seat switch wire and temporarily connect the two terminals with jumper wire **J** as shown.
4. Start the engine and run at low speed.
5. Move parking brake to the **OFF** position.
6. Loosen jam nuts **K** at both ends of the control rod **L**.
7. Rotate the control rod until the corresponding wheel stops turning. Lock the control rod jam nuts. Run the engine up to high idle and stroke the traction levers forward and back to check the adjustment. Move traction levers back to neutral and readjust if necessary.
8. Repeat steps 6 and 7 for the opposite side.
9. Remove the jumper wire and reconnect the seat switch.

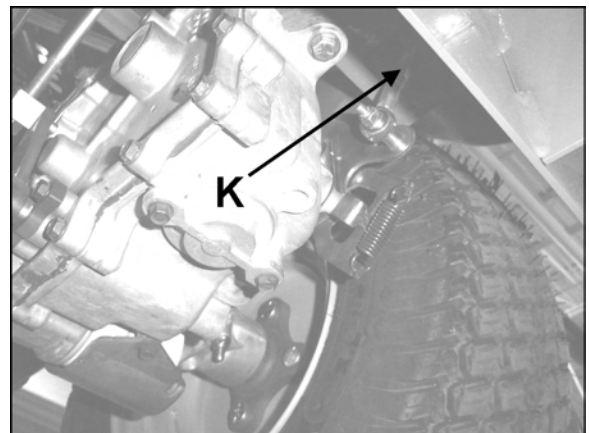
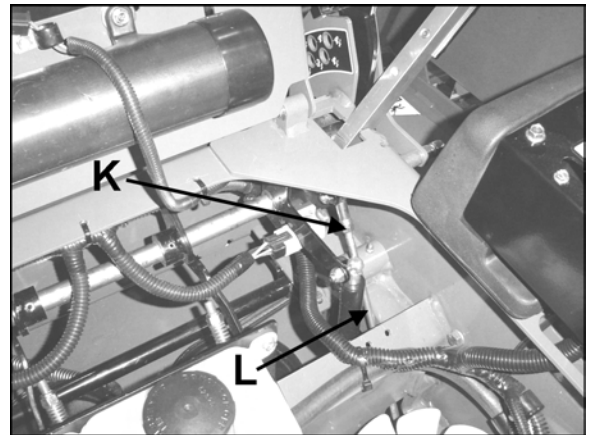
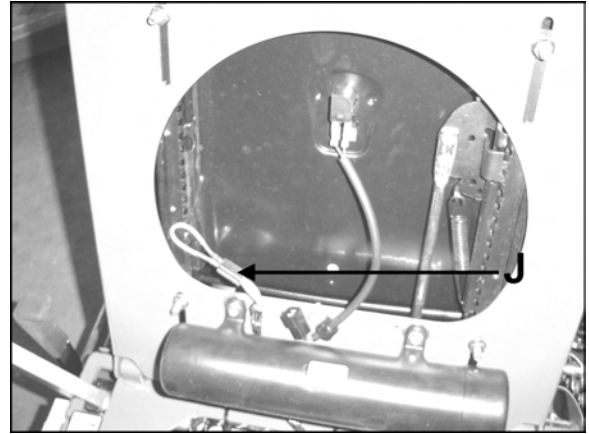

BELT REPLACEMENT

NOTE: Always use Craftsman Professional replacement belts, not general purpose belts. Craftsman Professional belts are specially designed for use on this mower and will normally last longer.

CUTTERDECK BELT

1. Remove floorplate.
2. Set the cutterdeck in a middle height-of-cut position.
3. Use a 3/8" ratchet and extension to back tensioning idler off to remove belt from idler. Remove belt from cutterdeck pulleys.

NOTE: Use the 3/8" ratchet in the square hole **A** on the idler.

4. Remove belt from clutch pulley.
5. Install the new belt by performing these steps in reverse order.

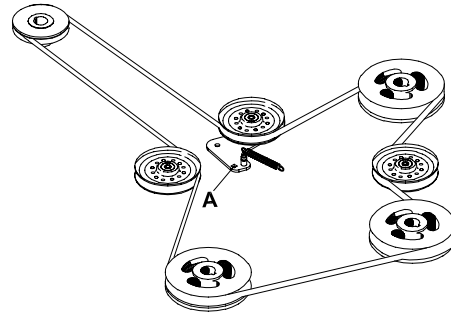

3 SPINDLE DECK

HYDRO TRANSAXLE DRIVE BELT

1. Remove cutterdeck belt (see cutterdeck belt replacement).
2. Disconnect wire **I** at clutch **M**. Remove bolts **J** and remove torque restraint.
3. Using a ratchet with a 9/16" socket, place over nut at location **P**. Use the ratchet to rotate it enough to remove the transaxle drive belt.
4. Install a new transaxle drive belt by performing these steps in reverse order.
5. Inspect the fans. Replace if worn or damaged. Torque transaxle pulley nut to 28.3-41.6 ft-lbs (38-56 Nm).
6. Reinstall cutterdeck belt (see cutterdeck belt replacement).

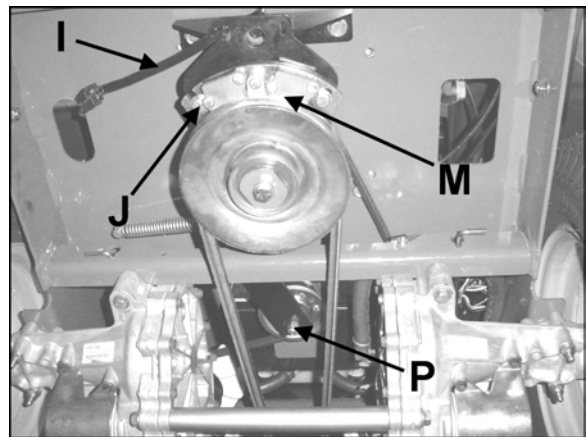

BELT TENSION

All belts are tensioned by spring loaded idlers and do not require any adjustment.

Get it fixed, at your home or ours!

Your Home

For expert troubleshooting and home solutions advice:

manage my home

www.managemyhome.com

For repair – **in your home** – of **all** major brand appliances, lawn and garden equipment, or heating and cooling systems, **no matter who made it, no matter who sold it!**

For the replacement parts, accessories and owner's manuals that you need to do-it-yourself.

For Sears professional installation of home appliances and items like garage door openers and water heaters.

1-800-4-MY-HOME[®] (1-800-469-4663)

Call anytime, day or night (U.S.A. and Canada)

www.sears.com www.sears.ca

Our Home

For repair of carry-in items like vacuums, lawn equipment, and electronics, call anytime for the location of your nearest

Sears Parts & Repair Service Center

1-800-488-1222 (U.S.A.)

www.sears.com

1-800-469-4663 (Canada)

www.sears.ca

To purchase a protection agreement on a product serviced by Sears:

1-800-827-6655 (U.S.A.)

1-800-361-6665 (Canada)

Para pedir servicio de reparación a domicilio, y para ordenar piezas:

1-888-SU-HOGAR[®]

(1-888-784-6427)

Au Canada pour service en français:

1-800-LE-FOYER^{MC}

(1-800-533-6937)

www.sears.ca

Sears

® Registered Trademark / TM Trademark / SM Service Mark of Sears Brands, LLC

® Marca Registrada / TM Marca de Fábrica / SM Marca de Servicio de Sears Brands, LLC

^{MC} Marque de commerce / ^{MD} Marque déposée de Sears Brands, LLC

© Sears Brands, LLC

Free Manuals Download Website

<http://myh66.com>

<http://usermanuals.us>

<http://www.somanuals.com>

<http://www.4manuals.cc>

<http://www.manual-lib.com>

<http://www.404manual.com>

<http://www.luxmanual.com>

<http://aubethermostatmanual.com>

Golf course search by state

<http://golfingnear.com>

Email search by domain

<http://emailbydomain.com>

Auto manuals search

<http://auto.somanuals.com>

TV manuals search

<http://tv.somanuals.com>