

**SEARS**

**OWNER'S  
MANUAL**

**MODEL NO.  
247.370251**

**Caution:  
Read and Follow  
All Safety Rules  
and Instructions  
Before Operating  
This Equipment**

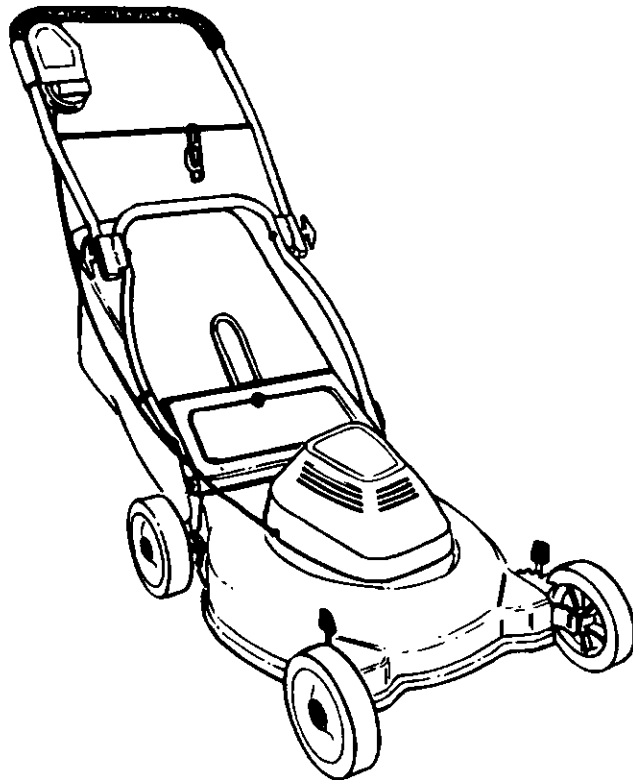

**CRAFTSMAN®**

**110V 12AMP ELECTRIC  
DOUBLE INSULATED  
19" REAR DISCHARGE  
MULCHING LAWN MOWER**

**Assembly  
Operation  
Customer Responsibilities  
Service and Adjustment  
Repair Parts**

This symbol on the products nameplate  
means it is listed by  
UNDERWRITERS LABORATORIES INC.



**SEARS, ROEBUCK AND CO., Hoffman Estates, IL 60179 U.S.A.**

# IMPORTANT

# SAFE OPERATION PRACTICES

THIS SYMBOL POINTS OUT IMPORTANT SAFETY INSTRUCTIONS WHICH, IF NOT FOLLOWED, COULD ENDANGER THE PERSONAL SAFETY AND/OR PROPERTY OF YOURSELF AND OTHERS. READ AND FOLLOW ALL INSTRUCTIONS IN THIS MANUAL BEFORE ATTEMPTING TO OPERATE YOUR ELECTRIC LAWN MOWER. FAILURE TO COMPLY WITH THESE INSTRUCTIONS MAY RESULT IN PERSONAL INJURY. WHEN YOU SEE THIS SYMBOL—  **HEED ITS WARNING.**

## DANGER:

Your electric lawn mower was built to be operated according to the rules for safe operation in this manual. As with any type of power equipment, carelessness or error on the part of the operator can result in serious injury. If you violate any of these rules, you may cause serious injury to yourself or others.

## TRAINING

- Read this owner's manual carefully in its entirety before attempting to assemble or operate this machine. Be completely familiar with the controls and the proper use of this machine before operating it. Keep this manual in a safe place for future and regular reference and for ordering replacement parts.
- Your rotary mower is a precision piece of power equipment, not a plaything. Therefore, exercise extreme caution at all times.
- Never allow children to operate a power mower. Only persons well acquainted with these rules of safe operation should be allowed to use your mower.
- No one should operate this unit while intoxicated or while taking medication that impairs the senses or reactions.
- Keep the area of operation clear of all persons, particularly small children and pets. Stop motor when they are in the vicinity of your mower. Although the area of operation should be completely cleared of foreign objects, an object may have been overlooked and could be accidentally thrown by the mower in any direction and cause serious personal injury to the operator or any others allowed in the area.

## PREPARATION

- Thoroughly inspect the area where the equipment is to be used. Remove all stones, sticks, wire, bones and other foreign objects which could be picked up and thrown by the mower in any direction and cause serious personal injury to the operator or any others allowed in the area.
- Always wear safety glasses or eye shields during operation or while performing an adjustment or repair, to protect eyes from foreign objects that may be thrown from the machine in any direction.
- Dress properly. Wear sturdy, rough-soled work shoes. Never operate a unit in barefeet, sandals or sneakers. Do not wear loose clothing or jewelry. They can be caught in moving parts. Use of rubber gloves and footwear is recommended when working outdoors.
- Never attempt to make a wheel or cutting height adjustment while the motor is running.
- Mow only in daylight or in good artificial light.
- Avoid dangerous environment—Never operate the equipment in the rain or in damp wet locations. Always be sure of your footing. A slip and fall can cause serious personal injury. Keep a firm hold on the handle and walk, never run. Do not over-reach—keep footing and balance at all times.
- Warning—To reduce the risk of electric shock hazard, use only with an extension cord suitable for outdoor use. Use only UL approved outdoor extension cords of adequate gauge (minimum 16 gauge recommended) which accept the lawn mower's plug. Extension cords are available at your nearest authorized service center or dealer.
- Cord sets—Make sure your cord set is in good condition. Use only a 100 foot 14 gauge UL approved outdoor power extension cord (part no. 629-0192 or equivalent). A 50 foot 16 gauge UL approved outdoor extension cord is an acceptable substitute. An undersized cord will cause a drop in line voltage resulting in loss of power and overheating.

- If extension cord is damaged in any manner while plugged in, pull extension cord from wall receptacle.
- To prevent disconnection of extension cord from mower during operation, be sure to use the cord restraint provided or make a knot as shown in the illustration below.

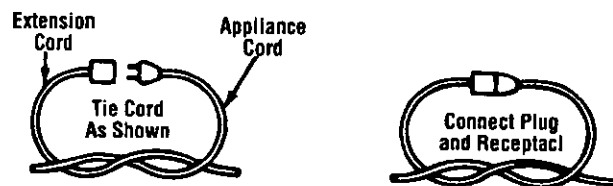

- Fuses—The mower should be operated on a 15 or 20 AMP circuit. If difficulty in starting is experienced with a standard 15 AMP fuse or circuit breaker, contact your nearest authorized service location. Do not use a higher rated fuse without consulting your power company.
- For your safety, use the slope gauge included as part of this manual to measure slopes before operating this unit on a sloped or hilly area. If the slope is greater than 15° as shown on the slope gauge, do not operate this unit on that area or serious injury could result.

## OPERATION

- Avoid accidental starting. Do not pull plugged-in lawn mower with finger on switch. Be sure switch is **off** when plugging in.
- Do not abuse cord—never pull lawn mower by cord or yank it to disconnect from receptacle. Keep cord from heat, oil, and sharp edges.
- Do not put hands or feet near or under rotating parts. Keep clear of the discharge opening at all times as the rotating blade can cause injury.
- Stop the motor when you leave the mower and before crossing gravel drives, walks or roads.
- After striking a foreign object, shut off the motor, make absolutely sure the blade and all moving parts have completely stopped, disconnect the power cord to prevent accidental starting, then thoroughly inspect the mower for any damage. Such damage must be repaired before restarting and operating the mower.
- If the equipment should start to vibrate abnormally, stop the motor and check immediately for the cause. Vibration is generally a warning of trouble.
- Stop the motor, unplug the power cord, and wait for the blade and all moving parts to stop before cleaning, unclogging chute, removing grass catcher, repairing or inspecting the mower. The cutting blade continues to rotate for a few seconds after the motor is shut off.
- Do not force lawn mower. It will do the job better and safer at the rate for which it was designed. Use right appliance—Do not use lawn mower for any job except that for which it is intended.

# SAFE OPERATION PRACTICES (Continued)

- Mow across the face of slopes, never up-and-down. Never cut grass by pulling mower toward you. Exercise extreme caution when operating mower on uneven terrain or changing direction on slopes. Do not mow excessively steep slopes. Always be sure of your footing. A slip and fall can cause serious personal injury.
- Never operate mower without proper guards, plates or other safety protective devices in place.
- **The blade/motor control on this mower is installed to minimize the risk of blade contact injury and is required by federal regulations. Do not under any circumstances attempt to defeat the function of the blade/motor control.**
- To avoid electric shock hazard, never push mower over cord. Do not mow around the lawn in circles. Always travel back and forth across the lawn, beginning at the point nearest the electric outlet to which the extension cord is connected. This will keep the cord on the mowed area of the lawn and out of the way.
- Do not operate mower after it has been dropped or damaged in any manner. Return mower to nearest authorized service location.
- The use of accessory attachments not recommended by the mower manufacturer may cause hazards. The use of any accessory on this rotary mower other than those manufactured by the mower manufacturer is not recommended.
- Do not operate this mower with the chute door open, unless the complete grass catcher is properly mounted on the mower.



## MAINTENANCE AND STORAGE

- Warning—Disconnect power cord from electrical outlet before performing any maintenance or service on mower.
- Check the blade and motor mounting bolts at frequent intervals for proper tightness. Keep all nuts, bolts, and screws tight to be sure the equipment is in safe working condition.

- Keep blade sharp.
- Use identical replacement blades only. Replace damaged cord.
- To reduce fire hazard, keep the motor free of grass, leaves, or excessive grease.
- Check the grass catcher bag frequently for wear or deterioration and replace worn bags. For safety protection, replace only with new bag meeting original equipment specifications.
- Store idle lawn mower indoors when not in use. Allow motor to cool before storing in any enclosure. Lawn mower should be stored indoors in dry, high or locked-up place, out of reach of children.
- Maintain lawn mower with care. Keep blade sharp and clean for best and safest performance. **Follow instructions for lubricating and changing accessories.**



## DOUBLE INSULATED LAWN MOWER

**DOUBLE INSULATION** IS A CONCEPT IN SAFETY IN ELECTRIC LAWN MOWERS, WHICH ELIMINATES THE NEED FOR THE USUAL THREE WIRE GROUNDED POWER CORD AND GROUNDED SUPPLY SYSTEM. WHEREVER THERE IS ELECTRIC CURRENT IN THE MOWER, THERE ARE TWO COMPLETE SETS OF INSULATION TO PROTECT THE USER. ALL EXPOSED METAL PARTS ARE ISOLATED FROM THE INTERNAL METAL MOTOR COMPONENTS WITH PROTECTING INSULATION.

**IMPORTANT**—SERVICING OF A LAWN MOWER WITH DOUBLE INSULATION REQUIRES EXTREME CARE AND KNOWLEDGE OF THE SYSTEM AND SHOULD BE PERFORMED ONLY BY A QUALIFIED SERVICE TECHNICIAN. FOR SERVICE WE SUGGEST YOU RETURN THE LAWN MOWER TO YOUR NEAREST AUTHORIZED SERVICE DEALER FOR REPAIR. ALWAYS USE ORIGINAL FACTORY REPLACEMENT PARTS WHEN SERVICING.

**CONGRATULATIONS** on your purchase of a Sears Craftsman Lawn Mower. It has been designed, engineered and manufactured to give you the best possible dependability and performance.

Should you experience any problem you cannot easily remedy, please return the lawn mower to the nearest Sears Service Center/Department in the United States. We have competent, well-trained technicians and the proper tools to service or repair this unit.

Please read and retain this manual. The instructions will enable you to assemble and maintain your lawn mower properly. Always observe the "SAFETY RULES."

## PRODUCT SPECIFICATIONS

Voltage:	110 - 120 AC
Amperage:	12
Hz:	60
Blade Bolt Torque:	450-600 in. lbs.

MODEL NUMBER **251.370251**

SERIAL NUMBER \_\_\_\_\_

DATE OF PURCHASE \_\_\_\_\_

THE MODEL AND SERIAL NUMBERS WILL BE FOUND ON A LABEL ATTACHED TO THE DECK, NEAR THE RIGHT REAR WHEEL.

YOU SHOULD RECORD BOTH SERIAL NUMBER AND DATE OF PURCHASE AND KEEP IN A SAFE PLACE FOR FUTURE REFERENCE.

## MAINTENANCE AGREEMENT

A Sears Maintenance Agreement is available on this product. Contact your nearest Sears store for details.

## CUSTOMER RESPONSIBILITIES

- Read and observe the safety rules.
- Follow a regular schedule in maintaining, caring for and using your lawn mower.
- Follow the instructions under "Customer Responsibilities" (page 10) and "Storage" sections of this Owner's Manual.

### ONE YEAR LIMITED WARRANTY ON CRAFTSMAN LAWN MOWER

For one year from the date of purchase, when this Craftsman Lawn Mower is maintained and lubricated according to the instructions in the owner's manual, Sears will repair, free of charge, any defect in material and workmanship.

If this Craftsman Lawn Mower is used for commercial purposes, this warranty applies for only 90 days from the date of purchase.

This warranty does not cover:

- Expendable items which become worn during normal use, such as mower blades or blade adapters.
- Repairs necessary because of operator abuse or negligence, including bent motor shafts and the failure to maintain the equipment according to the instructions contained in the owner's manual.

WARRANTY SERVICE IS AVAILABLE BY RETURNING THE CRAFTSMAN LAWN MOWER TO THE NEAREST SEARS SERVICE CENTER/DEPARTMENT IN THE UNITED STATES. THIS WARRANTY APPLIES ONLY WHILE THIS PRODUCT IS IN USE IN THE UNITED STATES.

This warranty gives you specific legal rights, and you may also have other rights which may vary from state to state.

SEARS, ROEBUCK AND CO., Department D/817WA, Hoffman Estates, IL 60179

# TABLE OF CONTENTS

SAFETY RULES .....	2	CUSTOMER RESPONSIBILITIES .....	10, 11
PRODUCT SPECIFICATIONS .....	4	SERVICE AND ADJUSTMENTS .....	11
CUSTOMER RESPONSIBILITIES .....	4	STORAGE .....	12
WARRANTY .....	4	TROUBLE SHOOTING .....	12
INDEX .....	5	REPAIR PARTS .....	13, 14
MOWER ACCESSORIES .....	5	SLOPE GAUGE .....	15
ASSEMBLY .....	6	PARTS ORDERING/SERVICE .....	BACK PAGE
OPERATION .....	7-10		

## INDEX

<b>A</b>		<b>H</b>		<b>S</b>	
Adjustments:		Handle Storage .....	12	Safety Rules .....	2
Cutting Height .....	9			Service and Adjustments:	
Handle Height .....	6	<b>L</b>		Cutting Height .....	10
Assembly:		Lubrication:		Rear Trail Shield .....	11
Handle .....	6	Motor .....	10	Service Recommendations .....	11
Grass Catcher .....	7	Wheels .....	10	Specifications .....	4
<b>B</b>		<b>M</b>		Starting the Motor/Blade .....	8
Blade:		Maintenance:		Stopping the Motor/Blade .....	8
Balancing .....	11	Agreement .....	4	Storage .....	12
Replacement .....	11	Blade Care/Replacement .....	11	<b>T</b>	
Sharpening .....	11	Cleaning .....	11	Table of Contents .....	5
<b>C</b>		Lubrication .....	10	Trouble Shooting Guide .....	12
Cleaning .....	11	<b>O</b>		<b>W</b>	
Controls:		Operating Mower .....	7-10	Warranty .....	4
Motor/Blade Control .....	8	<b>R</b>		Wheels:	
Height Adjustment Knob .....	8	Repair/Replacement Parts .....	13, 14	Adjusting Height .....	9
Cord Restraint .....	9	Responsibilities, Customer .....	3, 10, 11	Lubrication .....	10
Customer Responsibilities .....	3, 10, 11				
Cutting Heights .....	10				
<b>E</b>					
Extension Cord .....	2, 9, 11				

## MOWER ACCESSORIES

These accessories were available when the mower was purchased. They are also available at most Sears retail outlets, catalog and service centers. Most Sears stores can order repair parts for you, when you provide the model number of your mower.

### MOWER PERFORMANCE

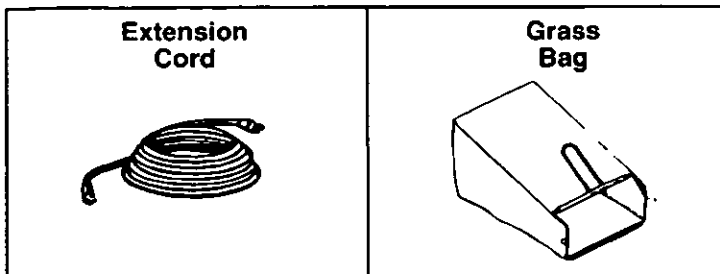

### MOWER MAINTENANCE

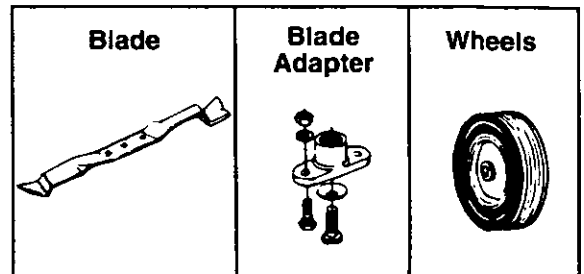

# ASSEMBLY

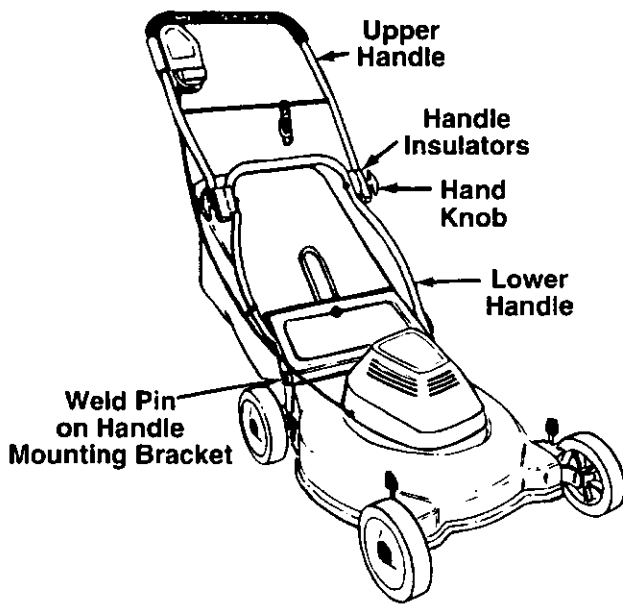

FIGURE 1.

## TO REMOVE MOWER FROM CARTON

Remove the carton inserts. Lift the mower from the carton, or cut the corners of the carton and roll the mower out. Make certain all parts and literature have been removed from the carton before the carton is discarded.

## HOW TO SET-UP YOUR MOWER

- Pull up and back on the lower handle. Pivot the upper handle up to raise the handle into the operating position. See figure 1.
- The upper handle may be adjusted to three different height positions. To select desired position, align one of the three marks on the top of the lower handle insulators with the mark on the upper handle insulators. Tighten the hand knobs.
- Remove the hairpin clips from the outer hole in the weld pins on the handle mounting brackets. Place the hairpin clips in the inner hole.

**NOTE:** The outer hole in the weld pin is for storage. The hairpin clip must be placed in the inner hole for operation.

**IMPORTANT:** YOUR MOWER IS SHIPPED WITH THE MULCHING BAFFLE IN PLACE. THE MULCHING BAFFLE ALLOWS THE BLADE TO CUT AND RECUT THE GRASS CLIPPINGS INTO SMALL PARTICLES, RETURNING THEM TO YOUR LAWN AS NUTRIENTS FOR THE SOIL.

IF YOU WISH TO BAG INSTEAD OF MULCH THE CLIPPINGS, SIMPLY LIFT THE REAR DISCHARGE DOOR, AND REMOVE THE MULCHING BAFFLE FROM THE REAR OF THE DECK BY PULLING OUTWARD ON THE BAFFLE. THEN ASSEMBLE AND ATTACH GRASS CATCHER AS FOLLOWS.

## ASSEMBLING THE GRASS CATCHER

**NOTE:** Make certain the grass bag is turned right side out before assembling (warning label will be on the outside).

- Join the rear frame and front frame assembly as shown in figure 2A. Push frames together as far as they will go.
- Place bag over frame (black plastic side is the bottom of bag) so the handle is outside the bag. Slip openings in the side of the plastic channel on bag over the hooks on the grass catcher frame.

**NOTE:** It may be necessary to pull the edge of the fabric away from the plastic channel in order to see the opening.

- Secure bag to frame by working the plastic channels on bag over frame as shown in figure 2B. All of the plastic channels except center top of bag attach from the outside of bag. Center top of bag attaches from the inside of bag.

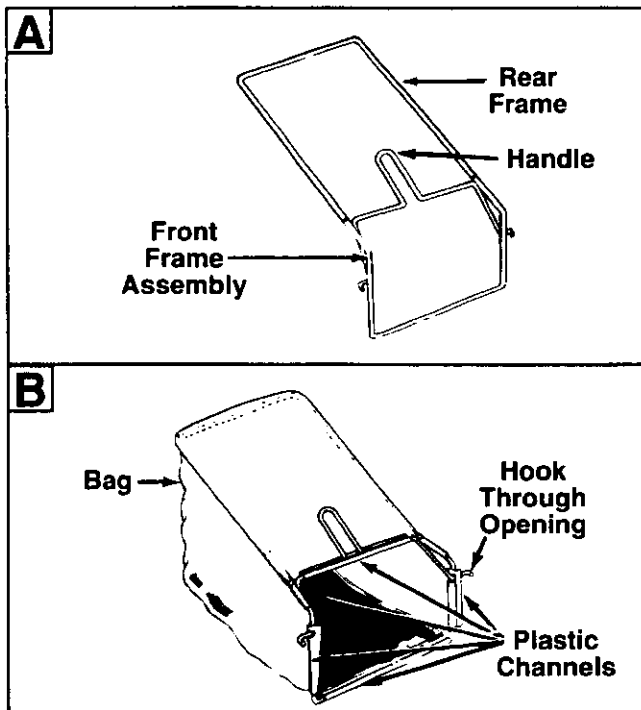

FIGURE 2.

# ASSEMBLY

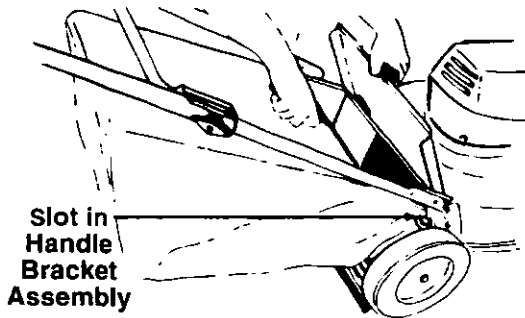

FIGURE 3.

## ATTACHING GRASS CATCHER TO MOWER

Lift the rear discharge door on the mower. Make certain the mulching baffle has been removed. Place the hooks on the grass catcher into the slots in the handle bracket assemblies. See figure 3. Release the rear discharge door.

To remove the grass catcher, lift the rear discharge door on the mower. Lift the grass catcher up, out of the slots in the handle bracket assemblies. Release the rear discharge door.



**WARNING: NEVER OPERATE MOWER UNLESS HOOKS ON GRASS CATCHER ARE SEATED IN SLOTS ON HANDLE BRACKET ASSEMBLIES, AND REAR DISCHARGE DOOR RESTS FIRMLY AGAINST TOP OF GRASS CATCHER.**

# OPERATION

## KNOW YOUR LAWN MOWER

READ THIS OWNER'S MANUAL AND SAFETY RULES BEFORE OPERATING YOUR LAWN MOWER. Compare the illustrations with your lawn mower to familiarize yourself with the location of various controls and adjustments. Save this manual for future reference.

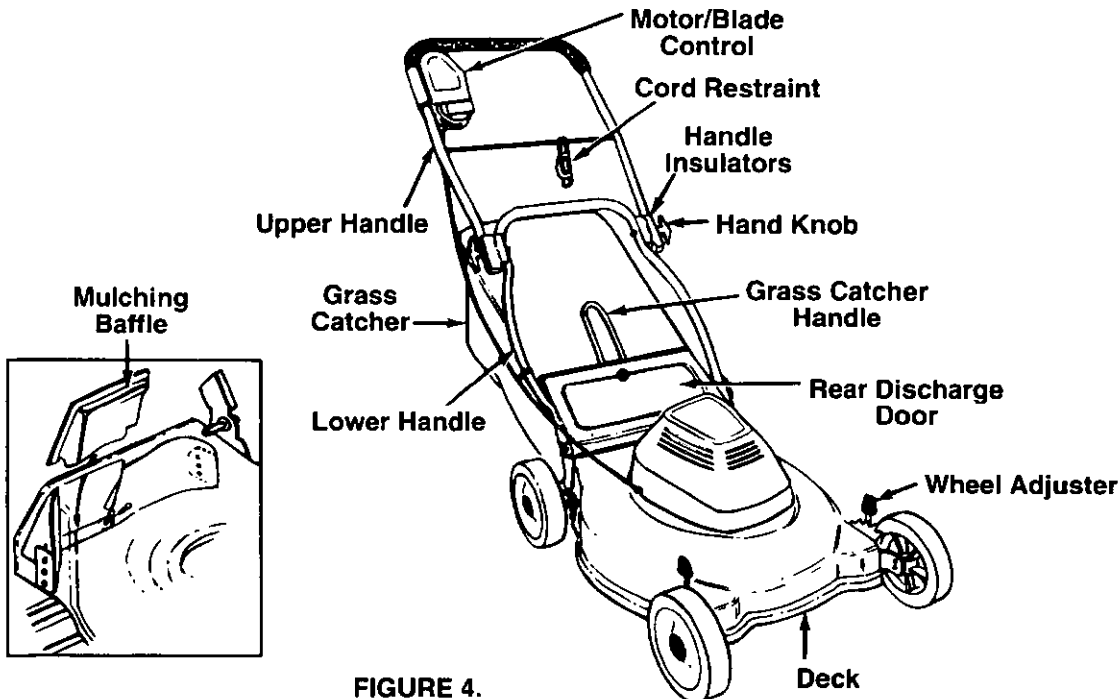

FIGURE 4.

## MEETS CPSC BLADE SAFETY REQUIREMENTS

Sears Lawn Walk-Behind Mowers conform to the safety standards of the American National Standards Institute, Underwriters Laboratories, Inc., and the U.S. Consumer Product Safety Commission. The blade turns when the engine is running.

**MOTOR/BLADE CONTROL LEVER**—must be held against the handle to start and run the motor and blade. Release to stop the motor and blade.

**CORD RESTRAINT**—helps prevent disconnection of extension cord from motor/blade control.

# OPERATION

BEFORE USING YOUR LAWN MOWER, AGAIN REFER TO THE "SAFETY RULES" AS SHOWN ON PAGE 2 OF THIS MANUAL. ALWAYS BE CAREFUL.



The operation of any lawn mower can result in foreign objects being thrown into the eyes, which can result in severe eye damage. Always wear safety glasses or eye shields before starting power tool operation or while performing any adjustments or repairs. We recommend Wide Vision Safety Mask for over spectacles or standard glasses available at Sears Retail or Catalog Stores.

## HOW TO USE YOUR MOWER



**WARNING: DO NOT OPERATE THIS MOWER WITH THE REAR DISCHARGE DOOR OPEN, UNLESS THE COMPLETE GRASS CATCHER IS IN PLACE. DO NOT OPERATE THE MOWER WITHOUT THE PROTECTIVE SHIELD ON THE REAR OF THE DECK IN PLACE.**



**WARNING: BE SURE THAT LAWN IS CLEAR OF STONES, STICKS, WIRES, OR OTHER OBJECTS WHICH COULD DAMAGE LAWN MOWER OR ENGINE. SUCH OBJECTS COULD BE ACCIDENTALLY THROWN BY THE MOWER IN ANY DIRECTION AND CAUSE SERIOUS PERSONAL INJURY TO THE OPERATOR AND OTHERS.**



**WARNING: TO PREVENT ELECTRIC SHOCK, DO NOT OPERATE THE MOWER IN DAMP OR WET LOCATIONS.**

### TO STOP MOTOR AND BLADE

- Release the motor/blade control handle to stop the engine and blade. (You will hear a high pitched noise, which is the result of deceleration of the electric motor. Sparking at the top of motor, inside the motor cover, is also normal during deceleration.)



**WARNING: THE BLADE CONTINUES TO ROTATE FOR A FEW SECONDS AFTER THE MOTOR IS SHUT OFF. IF MOTOR DOES NOT COME TO AN IMMEDIATE STOP WHEN THE MOTOR/BLADE CONTROL HANDLE IS RELEASED, CONTACT AN AUTHORIZED SERVICE LOCATION.**

- Disconnect the power source to prevent accidental starting while equipment is unattended.



**WARNING: IF YOU STRIKE A FOREIGN OBJECT, STOP THE MOTOR. DISCONNECT THE POWER SOURCE, THOROUGHLY INSPECT THE MOWER FOR ANY DAMAGE, AND REPAIR THE DAMAGE BEFORE RESTARTING AND OPERATING THE MOWER. EXTENSIVE VIBRATION OF THE MOWER DURING OPERATION IS AN INDICATION OF DAMAGE. THE UNIT SHOULD BE PROMPTLY INSPECTED AND REPAIRED.**

### TO START MOTOR AND ENGAGE BLADE

Standing behind the unit, lift the motor/blade control handle with the left forefinger, then pull handle up and hold it against the upper handle with right hand. See figure 5.

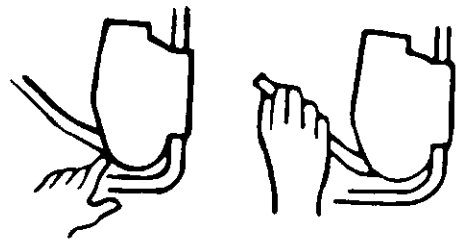

**FIGURE 5.**  
**MOTOR/BLADE CONTROL**



**WARNING: THE MOTOR/BLADE CONTROL ON THIS MOWER IS INSTALLED TO MINIMIZE THE RISK OF BLADE CONTACT INJURY AND IS REQUIRED BY FEDERAL REGULATIONS. DO NOT UNDER ANY CIRCUMSTANCES ATTEMPT TO DEFEAT THE FUNCTION OF THE MOTOR/BLADE CONTROL.**

The motor/blade control requires the operator to be behind the handle to start and run the mower. When the operator releases the control lever, the motor will stop and an internal brake helps the blade to stop quickly.

When the operator leaves the operating position to remove the grass catcher, change the cutting height, or pick up sticks or other objects in the way, the motor will stop automatically when the motor/blade control lever is released.



# OPERATION

## CUTTING HEIGHT ADJUSTMENT



**WARNING: TURN OFF MOTOR AND DISCONNECT POWER CORD BEFORE ADJUSTING THE CUTTING HEIGHT.**

Each wheel has an adjuster lever to set the cutting height on your mower. They should always be set to the same position.

- Raise wheels for low cut and lower wheels for high cut.
- To change cutting height, move adjuster levers toward wheels. See figure 6. Move wheels up or down to suit your requirements. Be sure all four levers are in the same setting.

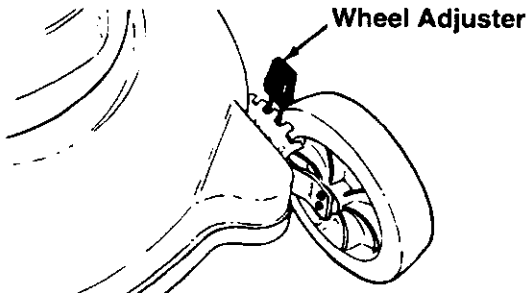

FIGURE 6.

- Adjust cutting height to suit your requirements. Refer to the "Mowing and Mulching Tips" on page 10. (The height adjusters may seem hard to move when new. They will operate easier after some use.)

## CORD CONNECTION EXTENSION CORD

**IMPORTANT: USE ONLY A 100 FOOT 14 GAUGE UL APPROVED OUTDOOR POWER EXTENSION CORD (PART NO. 629-0192 OR EQUIVALENT). A 50 FOOT 16 GAUGE UL APPROVED OUTDOOR EXTENSION CORD IS AN ACCEPTABLE SUBSTITUTE. USING ANY OTHER LENGTH OR RATING OF CORD WILL DIMINISH THE PERFORMANCE AND POSSIBLY THE LIFE OF THE ELECTRIC MOTOR.**

- The length of extension cord you will need (not provided with unit) depends on the size of the area to be mowed. See extension cord information in Safe Operation Practices.

## CORD RESTRAINT

- Attach extension cord to the cord restraint as follows. Form a small loop in the extension cord. Allow enough excess cord to make the connection to the motor/blade control (approximately 20 inches). Slip the loop through the slot on the bottom of the cord restraint, and up over the tab, to prevent disconnection from the motor/blade control during operation. Leave enough cord to allow the cord restraint to move freely from side to side. See figure 7.

## CONNECTION TO THE MOTOR/BLADE CONTROL

- To attach extension cord to the mower, swing open the spring-loaded plug retainer located beneath the motor/blade control. Connect the plug on the extension cord fully onto the plug on the mower. The mower is equipped with a polarized AC power plug (one blade of the plug is wider than the other), which will fit into the plug on the extension cord only one way. See figure 7, inset. If unable to make a full connection, try reversing the plug on the extension cord. Should the plugs still fail to fit, contact your service dealer for assistance. Do not defeat the safety purpose of the polarized plug.

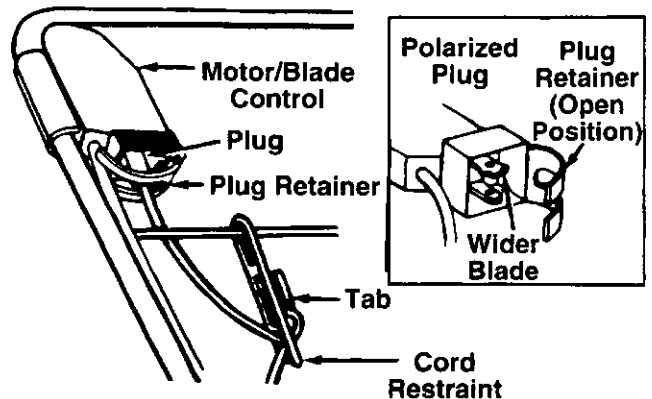

FIGURE 7.

## CONNECTION TO THE ELECTRIC POWER SOURCE

- Plug the extension cord into any convenient 110-120 volt 60 cycle A.C. outlet or receptacle for your source of power. This outlet may be located either out-of-doors or indoors. If an inside receptacle is used, the extension cord can be taken out either through the doorway or a window. To avoid blowing fuses, pick an outlet that is not overloaded. Your mower will operate satisfactorily on a circuit that is fused for 15 amperes. Do not use oversize fuses without consulting your power company.

## TO CONVERT MOWER TO MULCHER

- To convert the mower to a mulching mower, first remove the grass catcher. Then simply lift the rear discharge door, insert the mulching baffle, and release the rear discharge door.

## MOWING AND MULCHING TIPS

Never mow around the lawn in circles. Always travel back and forth across the lawn, beginning at the point nearest the electric outlet where cord is connected. See figure 8. Cut grass moving away from the outlet so the cord lies in the cut portion of the lawn, out of the way. Do not allow extension cord to wrap around trees, shrubs or other obstacles.

# OPERATION

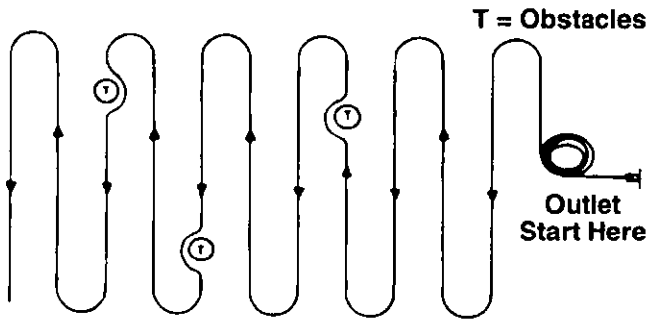

FIGURE 8.

The grass condition at the time of mowing determines the proper mower cutting height setting for best lawn appearance. For a healthy lawn, always cut one-third or less of the total length of the grass at any one cutting.

For extremely heavy cutting, reduce the width of cut.

When mulching under certain conditions, such as very tall grass, it may be necessary to raise the height of cut to reduce pushing effort and to keep from overloading the engine and leaving clumps of grass clippings. Under heavy conditions cross cut for additional mulching of surface debris.

When picking up the extension cord, wind the cord in a series of equal loops on each side of your hand to prevent snarling. See illustration at right.



## CUSTOMER RESPONSIBILITIES

### GENERAL RECOMMENDATIONS

- Follow the Maintenance Schedule below.



**WARNING: BE CERTAIN TO DISCONNECT THE POWER SUPPLY BEFORE PERFORMING ANY REPAIRS OR MAINTENANCE.**

### MAINTENANCE SCHEDULE

SERVICE RECORD	SCHEDULE			SERVICE DATES					
	Every Use	After First Two Hours	Every 25 Hours						
Fill in dates as you complete regular service									
Blade Replaced			√						
Lubricate Mower			√						
Cleaning	√								

√ CHECK

### LUBRICATION

#### MOTOR

The motor on your mower does not require lubrication.

#### WHEELS

DO NOT oil or grease the wheels. Viscous lubricants will attract dust and dirt that will shorten the life of the wheels. If you feel the wheels must be lubricated, use only a dry, silicone type lubricant sparingly.

#### WHEEL ADJUSTERS

For easy operation, lubricate the wheel adjusters at least once a season with light oil.

# CUSTOMER RESPONSIBILITIES

## MOWER

### BLADE CARE

Your mower will work better with a sharp blade.



**WARNING: BE CERTAIN TO DISCONNECT THE POWER SUPPLY BEFORE PERFORMING ANY MAINTENANCE.**

#### TO REMOVE BLADE (See Figure 9):

- Turn mower on its side.
- Use a block of wood between blade and mower deck to prevent blade from turning when bolt is removed. Protect your hands with gloves and/or wrap blade with heavy cloth.
- Remove center blade bolt by turning counterclockwise. Use a 9/16" box or open-end wrench.



**WARNING: PERIODICALLY INSPECT THE BLADE ADAPTER FOR CRACKS, ESPECIALLY IF YOU STRIKE A FOREIGN OBJECT. REPLACE WHEN NECESSARY.**

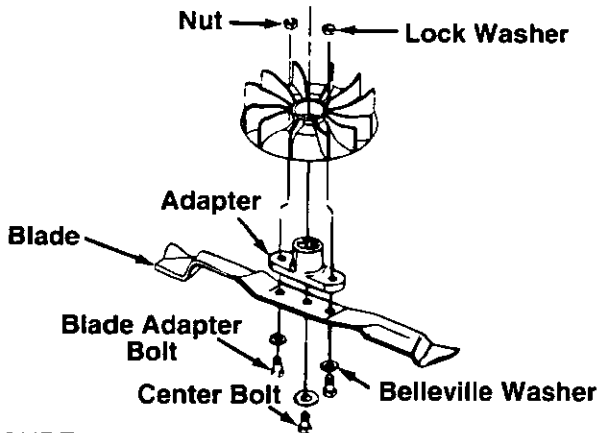

FIGURE 9.

#### TO REPLACE BLADE (See Figure 9):

- Put blade adapter on motor shaft.
- Fit blade in adapter. Be sure trailing edge of blade is up towards engine.
- Assemble bolts, washers, and nuts in the exact order of removal.
- Use block of wood to hold blade and tighten bolt clockwise. The recommended torque for the center blade bolt is 450-600 in. lbs. The recommended torque for the two blade adapter bolts is 200-300 in. lbs. Torque wrenches are available at most Sears stores and through the catalog.

**IMPORTANT: THE BOLT USED TO SECURE THE BLADE TO THE MOTOR SHAFT IS SPECIALLY HEAT-TREATED. DO NOT SUBSTITUTE.**



**CAUTION: A LOOSE BLADE CAN BE DANGEROUS AND MAY MAKE THE MOTOR HARD TO START.**

Use only a Sears authorized replacement blade to get the best cutting results.

#### TO SHARPEN BLADE

**NOTE: We do not recommend sharpening the blade—but if you do, be sure blade is balanced.**

- The blade can be sharpened with a file or on a grinding wheel. Do not attempt to sharpen while on the mower.
- Care should be taken to keep the blade balanced. An unbalanced blade will cause excessive vibration when running and eventual damage to mower and motor.
- To check blade balance, drive a nail into a beam or wall. Leave about one inch of straight nail exposed. Place center hole of blade over the head of the nail. If blade is balanced, it should remain in a horizontal position. If either end of the blade moves downward, blade is not balanced. Sharpen the heavy end until the blade is balanced.

## CLEANING



**WARNING: DISCONNECT POWER SUPPLY BEFORE CLEANING YOUR MOWER.**

- Remove any build-up of grass and leaves on or around motor cover. **DO NOT USE WATER.**
- Clean the underside of your mower after each use by turning the mower on its side and scraping to remove any build-up of grass, leaves, dirt or other matter. **DO NOT USE WATER.**
- Occasionally use a dry cloth to wipe mower.
- Wash grass bag periodically with water. Allow to dry thoroughly in the shade. Do not use heat.

**IMPORTANT: Under normal usage, the grass bag is subject to wear and should be checked periodically. Be certain any replacement bag complies with the mower manufacturer's specifications.**

# SERVICE AND ADJUSTMENTS

## REAR TRAIL SHIELD

The rear trail shield, attached between the rear wheels of your mower, is provided to minimize the possibility that objects will be thrown out the rear of the mower toward the operator. If the shield becomes damaged, it should be replaced.

## TO ADJUST CUTTING HEIGHT

Refer to "CUTTING HEIGHT ADJUSTMENT" in Operation section of manual.

# STORAGE

Your mower should be prepared for off-season storage as follows:

## MOWER

- Clean underside of mower housing (See "CLEANING" in Customer Responsibilities section of manual).
- Inspect and replace/sharpen blade, if required (See "BLADE CARE" in Customer Responsibilities section of manual).
- Lubricate as shown in "MAINTENANCE SCHEDULE" (See Customer Responsibilities section of manual).
- Make sure motor/blade control is in OFF (released) position for storage.

## HANDLE

The handle may be folded away completely for storage.

- Remove the grass bag (if attached).
- Loosen the hand knobs on the sides of the handle, and let the upper handle fold down to the rear.
- Pull outward on each side of the lower handle, and lift the sides of the lower handle past the edges of the handle mounting brackets. Fold the lower handle forward.

**CAUTION:** When folding the handle for storage or transportation, be careful not to bend or kink the power cord.

To return the mower to the operating position, pull up and back on the handle until it locks in position. Tighten the hand knobs which secure the upper and lower handles.

## EXTENSION CORD

- Replace extension cord if cut or abraded.
- Extension cord should be wiped dry of any foreign substances such as oil or stains.
- Wind cord and store in cool, dry place (See cord winding instruction on page 10).

## OTHER

Do not store your mower under any plastic cover. Plastic cannot breathe which allows condensation to form and causes metal components of mower to rust.

# TROUBLE SHOOTING GUIDE

Trouble	Possible Cause(s)	Corrective Action
Does not start	<ol style="list-style-type: none"> <li>1. Motor/blade control disengaged.</li> <li>2. Extension cord disconnected.</li> <li>3. Blown fuse or a tripped circuit breaker.</li> <li>4. Motor/blade control switch defective.</li> </ol>	<ol style="list-style-type: none"> <li>1. Engage motor/blade control.</li> <li>2. Be sure that the extension cord is plugged into the outlet and the lawn mower switch plug.</li> <li>3. Check to see if a fuse has been blown or a circuit breaker tripped in your electrical box.</li> <li>4. Replace motor/blade control switch.</li> </ol>
Frequent blowing of fuses	<ol style="list-style-type: none"> <li>1. Cutting too much grass.</li> <li>2. Circuit overloaded.</li> </ol>	<ol style="list-style-type: none"> <li>1. Set in "Higher Cut" position.</li> <li>2. Do not use a higher rated fuse without consulting your power company. If condition persists (be sure circuit is not overloaded), have your unit checked by your nearest Authorized Sears Service Dealer.</li> </ol>
Loss of power	<ol style="list-style-type: none"> <li>1. Cutting too much grass.</li> <li>2. Build-up of grass, leaves and debris under mower.</li> </ol>	<ol style="list-style-type: none"> <li>1. Set in "Higher Cut" position.</li> <li>2. Disconnect power cord and clean underside of mower housing.</li> </ol>
Poor or uneven cut	<ol style="list-style-type: none"> <li>1. Worn, bent or loose blade.</li> <li>2. Build-up of grass, leaves and debris under mower.</li> </ol>	<ol style="list-style-type: none"> <li>1. Replace blade. Tighten blade nut.</li> <li>2. Disconnect power cord and clean underside of mower housing.</li> </ol>
Too much vibration	<ol style="list-style-type: none"> <li>1. Worn, bent or loose blade.</li> <li>2. Bent motor shaft.</li> </ol>	<ol style="list-style-type: none"> <li>1. Replace blade. Tighten blade nut.</li> <li>2. Contact Sears Service Department.</li> </ol>
Hard to push	<ol style="list-style-type: none"> <li>1. High grass or cutting height too low.</li> <li>2. Rear of mower housing and blade dragging in heavy grass.</li> </ol>	<ol style="list-style-type: none"> <li>1. Raise cutting height.</li> <li>2. Raise cutting height.</li> </ol>

**Note:** For repairs beyond the minor adjustments listed above, contact your nearest SEARS Service Center.

# SEARS CRAFTSMAN 19" ELECTRIC MULCHING MOWER MODEL NO. 247.370251

## Repair Parts

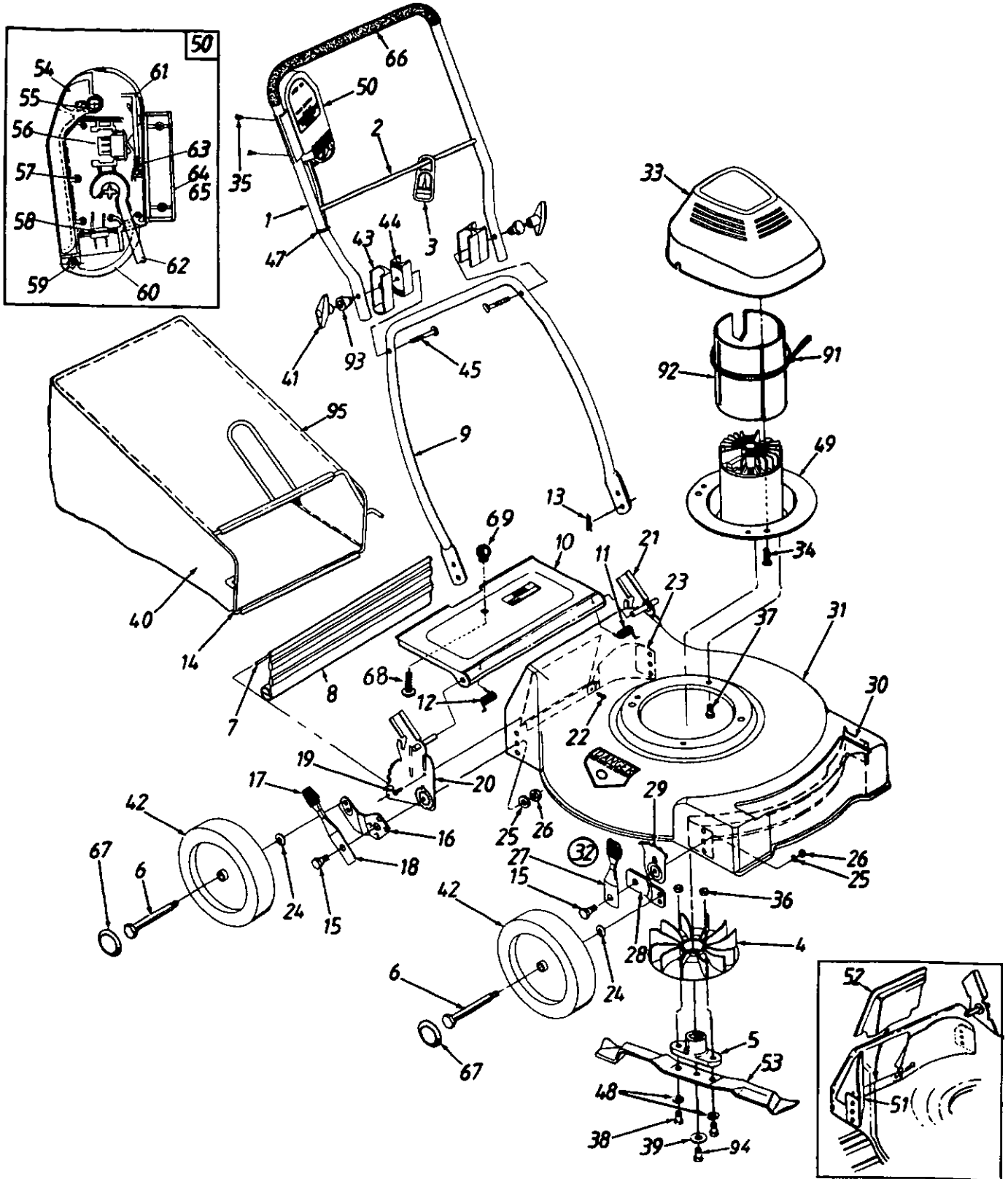

## Repair Parts

KEY NO.	PART NO.	DESCRIPTION	KEY NO.	PART NO.	DESCRIPTION
1	749-0881	Upper Handle	36	712-0241	Hex Nut 3/8-24 Thd.
2	747-0795	Cord Control Rod	37	710-1006	Hex TT-Tap Scr. 3/8-16 x .75" Lg.
3	725-1590	Strain Relief—Cord	38	710-0191	Hex Bolt 3/8-24 x 1.25" Lg.
4	731-1270	Fan	39	736-0452	Bell-Wash. .396" I.D. x 1.14"
5	748-0356	Blade Adapter	40	764-0447	Grass Bag
6	738-0102	Axle Bolt	41	720-0241	Plastic Knob
7	732-0712	Rear Flap Wire	42	734-1699	Wheel Ass'y. Comp.
8	731-1261	Rear Flap	43	731-1268	Upper Handle Insulator
9	749-0882	Lower Handle	44	731-1267	Lower Handle Insulator
10	782-7025	Chute Door	45	710-0450	Carriage Bolt 5/16-18 x 3" Lg.
11	732-0677	Door Spring—L.H.	46	712-0324	Hex Top L-Nut 1/4-20 Thd.
12	732-0678	Door Spring—R.H.	47	726-0303	Cable Tie
13	714-0104	Hairpin Clip	48	736-0331	Bell-Wash. 3/8" I.D.
14	764-0326	Front Catcher Frame	49	818-60013	Motor, Cord & Switch Ass'y.
15	738-0507B	Shld. Bolt .5" Dia. x .434"	50	624-0032	Cord & Switch Ass'y. Comp.†
16	14765	Pivot Bar—R.H.	51	782-5004	Mulching Baffle—R.R.
	14766	Pivot Bar—L.H. (Not Shown)	52	782-5007	Mulching Baffle Plug
17	720-0190	Spring Lever Knob	53	742-0719	19" Mulching Blade
18	732-0417A	Spring Lever	54	731-1210	Handle—Switch Actuator
19	710-0892	Hex AB-Tap Scr. 1/4 x .62" Lg.	55	732-0679	Spring—Switch Handle
20	682-0514	Handle Brkt. Ass'y.—R.H.	56	725-1565	Switch
21	682-0513	Handle Brkt. Ass'y.—L.H.	57	710-1147	Screw #6-32 x .5" Lg.
22	710-1017	Torx. Mach. AB-Tap Scr. 1/4 x .62" Lg.	58	729-0304	Plug Ass'y.
			59	732-0680	Retainer Plug Spring
23	782-5026	Rear Baffle	60	731-1211	Retainer Plug
24	736-0105	Bell-Wash. .38" I.D. x .88" O.D.	61	731-1198	Latch
25	736-0356	Bell-Wash. .39" I.D. x 1.38" O.D.	62	624-0053	Cord Ass'y. (Incl. Ref. #58)
26	712-0798	Hex Nut 3/8-16 Thd.*	63	732-0681	Spring Latch
27	14832	Spring Lever Ass'y. w/Knob	64	731-1208	Housing—Upper Half
28	15262B	Pivot Bar	65	731-1209	Housing—Lower Half (Not Shown)
29	15261A	Height Adj. Plate	66	720-0226	Foam Grip
30	782-5025	Front Baffle	67	720-0258	Hub Cap
31	782-0054	19" Deck	68	710-0192	Truss Scr. #10-24 x .38" Lg.
32	14578	Height Adj. Ass'y. Comp.—R.H.	69	720-0275	Knob
	14579	Height Adj. Ass'y. Comp.—L.H. (Not Shown)	70	624-0031	Brush and Liner Ass'y.†
33	731-1264	Motor Cover	71	724-0200	Brush Holder Cap†
34	710-1128	Scr. #10-16 x .75" Lg.	72	724-0201	End Shield Brushesc†
35	710-1150	Self-Tap. Scr. #7 x 1" Lg.	73	729-0328	Red Brush Lead†
			74	729-0329	Blue Brush Lead†
			75	741-0875	Needle Bearing†
			76	624-0028	Housing Magnet Ass'y.†
			77	624-0029	Armature Ass'y.†
			78	724-0194	Motor End Plate†
			79	741-0124	Ball Bearing†
			80	748-0348	Bearing Adapter†
			81	725-1565	Switch Motor†
			82	624-0053	Cord Ass'y.†
			83	710-1176	Carriage Bolt†
			84	712-0324	Hex L-Nut 1/4-20 Thd.†
			85	721-0305	Wire Insulator (Output)†
			86	721-0306	Motor Hsg. Insulator†
			87	724-0202	Cover-Rectifier†
			88	725-1602	Rectifier†
			89	731-1207	Strain Relief Bushing†
			90	736-3090	Fl-Wash. .26" I.D. x .72" O.D.†
			91	726-0209	Cable Tie
			92	721-0311	Insulator Motor Hsg.
			93	731-1388	Insulator—Knob
			94	710-1251	Hex Bolt 3/8-24 x 2.5"
			95	764-0325	Rear Catcher Frame
			—	770-7975J	Owner's Manual

\*Common Hardware—May be purchased locally.

†Part of Motor, Switch &amp; Cord Ass'y. Comp. (Ref. 49)

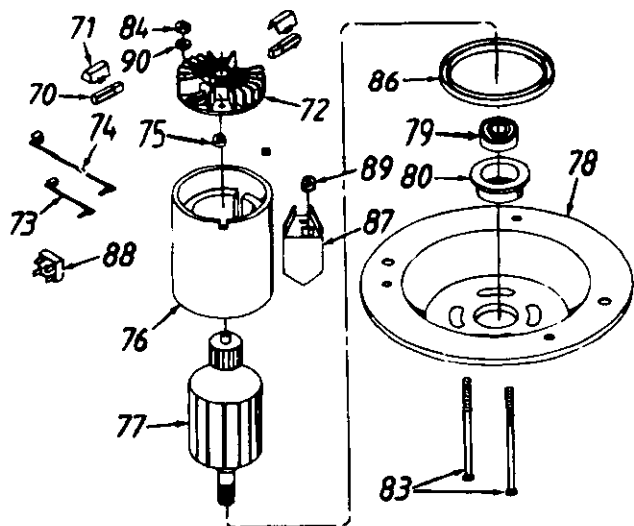

USE THIS PAGE AS A GUIDE TO DETERMINE SLOPES WHERE YOU MAY NOT OPERATE SAFELY.

# SLOPE GAUGE

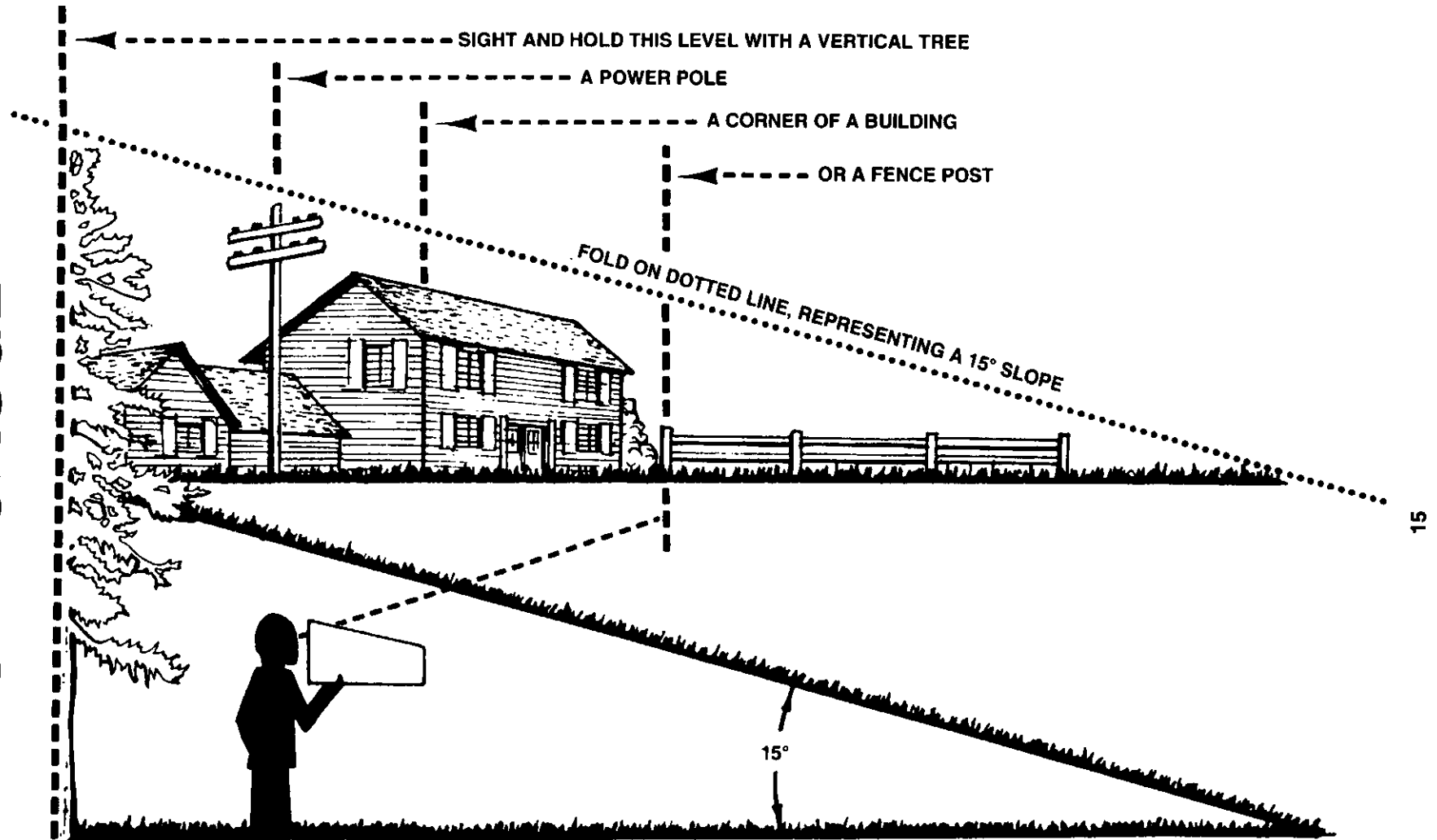

15



**WARNING**

Do not mow on inclines with a slope in excess of 15 degrees (a rise of approximately 2-1/2 feet every 10 feet). A riding mower could overturn and cause serious injury. If operating a walk-behind mower on such a slope, it is extremely difficult to maintain your footing and you could slip, resulting in serious injury.

Operate RIDING mowers up and down slopes, never across the face of slopes.

Operate WALK-BEHIND mowers across the face of slopes, never up and down slopes.

# SEARS

## OWNER'S MANUAL

MODEL NO.  
247.370251

## HOW TO ORDER REPAIR PARTS

# CRAFTSMAN®

## 110V 12AMP ELECTRIC DOUBLE INSULATED 19" REAR DISCHARGE MULCHING LAWN MOWER

Each lawn mower has its own model number.

The model number for your lawn mower will be found on a label attached to the deck, near the right rear wheel.

All parts listed herein may be ordered through Sears, Roebuck and Co. Service Centers and most Retail Stores.

### WHEN ORDERING REPAIR PARTS, ALWAYS GIVE THE FOLLOWING INFORMATION:

- \* PRODUCT - "Electric Mulching Mower"
- \* MODEL NUMBER - 247.370251
- \* PART NUMBER
- \* PART DESCRIPTION

Your Sears merchandise has added value when you consider that Sears has service units nationwide staffed with Sears trained technicians...professional technicians specifically trained on Sears products, having the parts, tools and the equipment to insure that we meet our pledge to you..."we service what we sell."

SEARS, ROEBUCK AND CO., Hoffman Estates, IL 60179 U.S.A.



# WHITE



**OUTDOOR POWER  
PRODUCTS**

**P.O. Box 361131 • Cleveland, Ohio • 44136  
97 Kent Avenue • Kitchener, Ontario • N2G 4J1**



## Free Manuals Download Website

<http://myh66.com>

<http://usermanuals.us>

<http://www.somanuals.com>

<http://www.4manuals.cc>

<http://www.manual-lib.com>

<http://www.404manual.com>

<http://www.luxmanual.com>

<http://aubethermostatmanual.com>

Golf course search by state

<http://golfingnear.com>

Email search by domain

<http://emailbydomain.com>

Auto manuals search

<http://auto.somanuals.com>

TV manuals search

<http://tv.somanuals.com>