

Operator's Manual

**CRAFTSMAN®**

**NEXTEC**

# 12-Volt Lithium-Ion Cordless Multi-Tool

Model No. 320. 61199

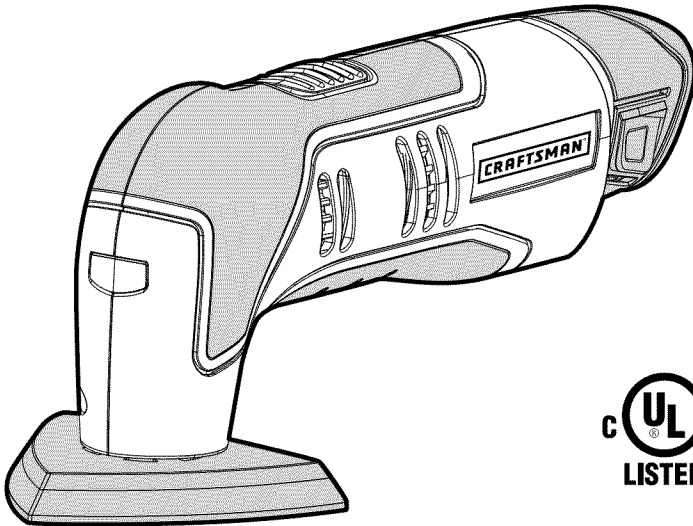

**⚠ WARNING:** To reduce the risk of injury, the user must read and understand the Operator's manual before using this product.

- Warranty
- Safety
- Assembly
- Operation
- Maintenance

**Charge battery  
Before first use**

**Sears, Roebuck and Co., Hoffman Estates, IL 60179 U.S.A.**

[www.craftsman.com](http://www.craftsman.com)

## TABLE OF CONTENTS

Warranty	page 2
Safety Symbols	page 3
Safety Instructions	pages 4-12
Description	page 13
Assembly	pages 13-14
Operation	pages 14-22
Application	Page 23
Maintenance	pages 24-25
Troubleshooting	page 26
Exploded View and Part List	page 27
Sears Repair Parts Phone Number	Back Cover

### **ONE YEAR FULL WARRANTY ON CRAFTSMAN® TOOL**

If this Craftsman tool fails to give complete satisfaction within one year from the date of purchase, return it to any Sears store or Parts & Repair Center or other Craftsman outlet in the United States for free repair (or replacement, if repair proves impossible).

This warranty does not include expendable parts such as lamps, batteries, bits, or blades.

This warranty applies for only 90 days from the date of purchase if this product is ever used for commercial or rental purposes.

This warranty gives you specific legal rights, and you may also have other rights which vary from state to state.

Sears, Roebuck and Co., Hoffman Estates IL 60179

## **INTRODUCTION**

### **SAVE THESE INSTRUCTIONS!**

This cordless Multi-Tool has many features for making its use more pleasant and enjoyable. Safety, performance, and dependability have been given top priority in the design of this product making it easy to maintain and operate.

**▲ WARNING:** Some dust created by using power tools contains chemicals known to the state of California to cause cancer and birth defects or other reproductive harm.

## SAFETY SYMBOLS

The purpose of safety symbols is to attract your attention to possible dangers. The safety symbols and the explanations with them deserve your careful attention and understanding. The symbol warnings do not, by themselves, eliminate any danger. The instructions and warnings they give are no substitutes for proper accident prevention measures.

**⚠ WARNING:** Be sure to read and understand all safety instructions in this manual, including all safety alert symbols such as “DANGER,” “WARNING,” and “CAUTION,” before using this tool. Failure to following all instructions listed below may result in electric shock, fire, and/or serious personal injury.

### SYMBOL SIGNAL MEANING

**⚠ DANGER:** Indicates an imminently hazardous situation, which, if not avoided, will result in death or serious injury.

**⚠ WARNING:** Indicates a potentially hazardous situation, which, if not avoided, could result in death or serious injury.

**⚠ CAUTION:** Indicates an imminently hazardous situation, which, if not avoided, may result in death or serious injury.

**NOTE:** (Without Safety Alert Symbol) Indicates a situation that may result in property damage.

**⚠ WARNING:** To ensure safety and reliability, all repairs should be performed by a qualified service technician at a Sears Service Center.



**⚠ WARNING:** The operation of any power tool can result in foreign objects being thrown into your eyes, which can result in severe eye damage. Before beginning power tool operation, always wear safety goggles or safety glasses with side shields and a full-face shield when needed. We recommend a Wide Vision Safety Mask for use over eyeglasses or standard safety glasses with side shields. Always use eye protection which is marked to comply with ANSI Z87.1

### SAVE THESE INSTRUCTIONS

Some of these following symbols may be used on this tool. Please study them and learn their meaning. Proper interpretation of these symbols will allow you to operate the tool better and safer.

SYMBOL	NAME	DESIGNATION/EXPLANATION
V	Volts	Voltage
A	Amperes	Current
Hz	Hertz	Frequency (cycles per second)
W	Watt	Power
min	Minutes	Time
~	Alternating Current	Type of current
≡	Direct Current	Type or a characteristic of current
$n_0$	No Load Speed	Rotational speed, at no load
	Class II Construction	Double-insulated construction
.../min	Per Minute	Revolutions, strokes, surface speed, orbits, etc., per minute
	Wet Conditions Alert	Do not expose to rain or use in damp locations.
	Read The Operator's Manual	To reduce the risk of injury, user must read and understand operator's manual before using this product.
	Eye Protection	Always wear safety goggles or safety glasses with side shields and a full face shield when operating this product.
	Safety Alert	Precautions that involve your safety.
	No Hands Symbol	Failure to keep your hands away from the blade will result in serious personal injury.
	No Hands Symbol	Failure to keep your hands away from the blade will result in serious personal injury.
	No Hands Symbol	Failure to keep your hands away from the blade will result in serious personal injury.
	No Hands Symbol	Failure to keep your hands away from the blade will result in serious personal injury.
	Hot Surface	To reduce the risk of injury or damage, avoid contact with any hot surface.

# SAFETY INSTRUCTIONS

## GENERAL SAFETY RULES

**⚠ WARNING:** Read and understand all instructions. Failure to follow all instructions listed below may result in electric shock, fire, and/or serious personal injury. The term “power tool” in all of warnings listed below refers to corded power tools or battery-operated (cordless) power tools.

## READ AND SAVE THESE INSTRUCTIONS

### WORK AREA SAFETY

- Keep your work area clean and well lit. Cluttered or dark areas invite accidents
- Do not operate power tools in explosive environments, such as in the presence of flammable liquids, gases, or dust. Power tools create sparks, which may ignite the dust or fumes.
- Keep children and bystanders away while operating a power tool. Distractions may cause you to lose control.

### ELECTRICAL SAFETY

- Avoid body contact with grounded surfaces, such as pipes, radiators, ranges, and refrigerators. There is an increased risk of electric shock if your body is grounded.
- Power tool plugs must match the outlet. Never modify the plug in any way. Do not use any adaptor plugs with grounded power tools. Unmodified plugs and matching outlets will reduce the risk of electric shock.
- Do not expose power tools to rain or wet conditions. Water entering a power tool will increase the risk of electric shock.
- Do not abuse the cord. Never use the cord for carrying, pulling, or unplugging the power tool. Keep the cord away from heat, oil, sharp edge, or moving parts. Damaged or entangled cords increase the risk of electric shock.
- When operating a power tool outdoors, use an extension cord suitable for outdoor use. Use of a cord suitable for outdoor use reduces the risk of electric shock.
- Use the battery only with the charger listed:

BATTERY PACK	CHARGER
320.11221	320.10006

## PERSONAL SAFETY

- Stay alert, watch what you are doing and use common sense when operating a power tool. Do not use a power tool while tired or under the influence of drugs, alcohol, or medication. A moment of inattention while operating power tools may result in serious personal injury.
- Use safety equipment. Always wear eye protection. Safety equipment, such as dust mask, non-skid safety shoes, hard hat, and hearing protection, when used for appropriate conditions, will reduce personal injuries.
- Avoid accidental starting. Make sure that the switch is in the “OFF” position before plugging the tool into an electrical outlet. Carrying power tools with your finger on the switch or plugging in power tools that have the power switch “ON” invites accidents.
- Remove any adjusting key or wrench before turning the power tool on. A wrench or key left attached to a rotating part of the power tool may result in personal injury.
- Do not overreach. Keep proper footing and balance at all times. This enables better control of the power tool in unexpected situations.
- Dress properly. Do not wear loose clothing or jewelry. Keep your hair, clothing, and gloves away from moving parts. Loose clothes, jewelry, or long hair can be caught in moving parts.
- If devices are provided for the connection of dust extraction and collection facilities, make sure that these are connected and properly used. Use of these devices can reduce dust-related hazards.
- Use clamps or another practical way to support and secure the workpiece to a stable platform. Holding the work by hand or against your body leaves it unstable and may lead to loss of control.
- Do not use on a ladder or unstable support. Stable footing on a solid surface enables better control of the power tool in unexpected situations.
- Keep handles dry, clean, and free from oil and grease. Slippery hands cannot safely control the power tool.
- Always wear safety glasses with side shields. Everyday glasses may have impact-resistant lenses, but they are NOT safety glasses. Following this rule will reduce the risk of eye injury.
- Protect your lungs. Wear a face or dust mask if the operation is dusty. Following this rule will reduce the risk of serious personal injury.
- Protect your hearing. Wear hearing protection during extended periods of operation. Following this rule will reduce the risk of serious person injury.

## POWER TOOL USE AND CARE

- Do not force the power tool. Use the correct power tool for your application. The correct power tool will do the job better and more safely at the rate for which it was designated.
- Do not use the power tool if the switch does not turn it ON and OFF. Any power tool that cannot be controlled with the switch is dangerous and must be repaired.
- Disconnect the plug from the power source and/or the battery pack from the power tool before making any adjustments, changing accessories, or storing power tools. Such preventive safety measures reduce the risk of starting the power tool accidentally.
- Store idle power tools out of the reach of children and do not allow persons unfamiliar with the power tool or these instructions to operate the power tool. Power tools are dangerous in the hands of untrained users.
- Maintain power tools. Check for misalignment or binding of moving parts, breakage of parts and any other condition that may affect the power tool's operation. If damaged, have the power tool repaired before use. Many accidents are caused by poorly maintained power tools.
- Keep cutting tools sharp and clean. Properly maintained cutting tools with sharp cutting edges are less likely to bind and are easier to control.
- Use the power tool, accessories, blades, etc. in accordance with these instructions and in the manner intended for the particular type of power tool, taking into account the working conditions and the work to be performed. Use of the power tool for operations different from those intended could result in a hazardous situation.
- Hold power tools by the insulated gripping surfaces when performing any operation in which the cutting tool may contact hidden wiring or its own cord. Contact with a "live" wire will also make exposed metal parts of the tool "live" and can shock the operator.
- Know your power tool. Read the product manual carefully. Learn the applications and limitations, as well as the specific, potential hazards related to this tool. Following this rule will reduce the risk of electric shock, fire or serious injury.
- Save these instructions. Refer to them frequently and use them to instruct others who may use this tool. If you lend this tool to someone else, also lend them these instructions.

## BATTERY TOOL USE AND CARE

- Make sure that the switch is in the OFF position before inserting the battery pack. Inserting the battery pack into power tools that have the switch ON invites accidents.
- Recharge only with the charger specified by the manufacturer. A charger that is suitable for one type of battery pack may create a risk of fire when used with another battery pack.
- Use power tools only with specifically designated battery packs. Use of any other battery packs may create a risk of injury and fire.
- When the battery pack is not in use, keep it away from other metal objects, such as paper clips, coins, keys, nails screws, or other small metal objects that can make a connection from one terminal to another. Shorting the battery terminals together may cause burns or a fire.
- Battery tools do not have to be plugged into an electrical outlet; therefore, they are always in operating condition. Be aware of possible hazards when not using your battery tool or when changing accessories. Following this rule will reduce the risk of electric shock, fire, or serious personal injury.
- Do not place battery tools or their batteries near fire or heat. This will reduce the risk of explosion and possible injury.
- Do not crush, drop or damage the battery pack. Do not use a battery pack or charger that has been dropped or received a sharp blow. A damaged battery is subject to explosion. Properly dispose of a dropped or damaged battery immediately.
- A damaged battery is subject to explosion. Properly dispose of a dropped or damaged battery immediately.
- Batteries vent hydrogen gas and can explode in the presence of a source of ignition, such as a pilot light. To reduce the risk of serious personal injury, never use any cordless product in the presence of open flame. An exploded battery can propel debris and chemicals. If exposed to such debris or chemicals, immediately flush the exposed area with water.
- Do not charge a battery tool in a damp or wet location. Following this rule will reduce the risk of electric shock.
- Under extreme usage or temperature conditions, battery leakage may occur.
- If contact accidentally occurs, flush with water. If liquid contacts eyes, seek medical help. Liquid ejected from the battery may cause irritation or burns.
- If liquid comes in contact with your skin, wash immediately with soap and water, then neutralize with lemon juice or vinegar.
- If liquid from the battery gets in your eyes, flush them with clean water for at least 10 minutes, and then seek immediate medical attention. Following this rule will reduce the risk of serious personal injury.



## SERVICE

- Have your power tool serviced by a qualified repair person.
- When servicing a power tool, use only identical replacement parts.
- Follow instructions in the Maintenance section of this manual. Use of unauthorized parts or failure to follow Maintenance instructions may create a risk of shock or injury.

## SPECIFIC SAFETY RULES FOR CORDLESS MULTI-TOOL

- Never use your Multi-Tool to perform sanding or separating operations in wet conditions.
- Always wear eye protection.
- Always wear ear protection during extended periods of operation.
- Always wear a dust mask if the operation is dusty.
- Wear protective gloves when changing application accessories. Application accessories become hot after prolonged usage.
- Always inspect for and remove all nails, screws, staples, etc. before sanding.
- Always check walls and ceilings to avoid hidden power cables and pipes. A metal detector (available separately) is very helpful for this purpose.
- Whenever possible, use clamping devices or other suitable means to secure the workpiece to a firm surface.
- When working with the machine, always hold it firmly with both hands and provide for a secure stance. The power tool is guided more securely with both hands.
- Keep your workplace clean. Blends of materials are particularly dangerous. Dust from light alloys can burn or explode.
- Avoid unintentionally switching on the tool. Ensure that the on/off switch is in the OFF position before inserting the battery pack. Do not carry the power tool with your finger on the on/off switch or insert the battery pack into power tools that have the switch on.
- Do not open the battery. Danger of short-circuiting.
- Do not scrape wet or dampened materials (e.g. wallpaper) or on moist surfaces. Penetration of water into the machine increases the risk of an electric shock.
- Do not treat the surface to be worked with solvent-containing fluids. Materials being heated by the scraping can cause toxic vapors to develop.
- Exercise extreme caution when handling the scraper accessory. The accessory is very sharp; danger of injury.
- Use only the original Craftsman accessories and the other accessories (Fein and Rockwell Multi-Tool Accessories) available for this Multi-Tool, no others.

- Only use application accessories in good condition. Do not use them if they are torn or worn.
- Do not restart a cutting operation in the workpiece. To resume a cutting operation: while keeping the tool from contacting the workpiece, allow the tool reach full speed and then carefully guide the cutting accessory into the cut.
- Keep your hands away from the cutting area. Do not reach under the material being cut.
- Hold power tools by their insulated gripping surfaces when performing an operation where the cutting tool may contact hidden wiring or its own cord. Contact with a “live” wire will make exposed metal parts of the tool “live” and shock the operator.



**⚠ WARNING:** Wear ear protection. Exposure to noise can cause hearing loss.

## SAFETY RULES FOR CHARGER

**⚠ WARNING:** Read and understand all instructions. Failure to follow all instructions listed below may result in electric shock, fire, and/or serious personal injury.

**⚠ WARNING:** Before using the battery charger, read all instructions and cautionary markings in this manual and on the battery charger, the battery, and the product using the battery to prevent misuse of the products and possible injury or damage.

**⚠ CAUTION:** To reduce the risk of electric shock or damage to the charger and battery, charge only those lithium-ion rechargeable batteries specifically designated on your charger’s label. Other types of batteries may burst, causing personal injury or damage.

- Do not use the charger outdoors or expose it to wet or damp conditions. Water entering the charger will increase the risk of electric shock.
- Use of an attachment not recommended or sold by the battery-charger manufacturer may result in a risk of fire, electric shock, or injury.
- Do not abuse the cord or charger. Never use the cord to carry the charger. Do not pull the charger cord to disconnect the plug from receptacle. Damage to the cord or charger could occur and create an electric shock hazard. Replace damaged cords immediately.
- Make sure that the cord is located so that it will not be stepped on, tripped over, come in contact with sharp edges or moving parts, or otherwise be subjected to damage or stress. This will reduce the risk of accidental falls, which could cause injury and damage to the cord and which could then result in electric shock.

- Keep the cord and charger from heat to prevent damage to housing or internal parts.
- Do not allow gasoline, oils, petroleum-based products, etc. to come in contact with plastic parts. These materials contain chemicals that can damage, weaken, or destroy plastic.
- An extension cord should not be used unless absolutely necessary. Use of an improper extension cord could result in a risk of fire and electric shock. If an extension cord must be used, make sure that:

The pins on plug of extension cord are the same number, size and shape as those of the plug on charger.

The cord is properly wired and in good electrical condition

The size is large enough for AC ampere rating of charger as specified below:

The Cord Length (Feet)	25'	50'	100'
Cord Size (AWG)	16	16	16

**NOTE:** AWG = American Wire Gauge

- Do not operate the charger with a damaged cord or plug, as this could cause shorting and electric shock. If damaged, have the charger repaired or replaced by an authorized service technician at a Sears Service Center.
- Do not operate the charger if it has received a sharp blow, been dropped, or has otherwise been damaged in any way. Take it to an authorized service technician at a Sears Service Center for an electrical check to determine if the charger is in good working order.
- Do not disassemble the charger. Take it to an authorized service technician at a Sears Service Center when service or repair is required. Incorrect reassembly may result in a risk of electric shock or fire.
- Unplug the charger from the electrical outlet before attempting any maintenance or cleaning to reduce the risk of electric shock.
- Disconnect charger from the power supply when not in use. This will reduce the risk of electric shock or damage to the charger if metal items should fall into the opening. It will also help prevent damage to the charger during a power surge.
- Risk of electric shock. Do not touch the uninsulated portion of output connector or uninsulated battery terminal.
- Save these instructions. Refer to them frequently and use them to instruct others who may use this tool. If you lend this tool to someone else, also lend these instructions to them to prevent misuse of the product and possible injury.

# IMPORTANT SAFETY INSTRUCTIONS

- Save these instructions. This manual contains important safety and operating instructions for 12V Multi-Tool 320.61199.
- Before using the ,battery charger, read all instructions and cautionary markings on battery charger, the battery and the product using battery, as well as the operator's manuals for these products.

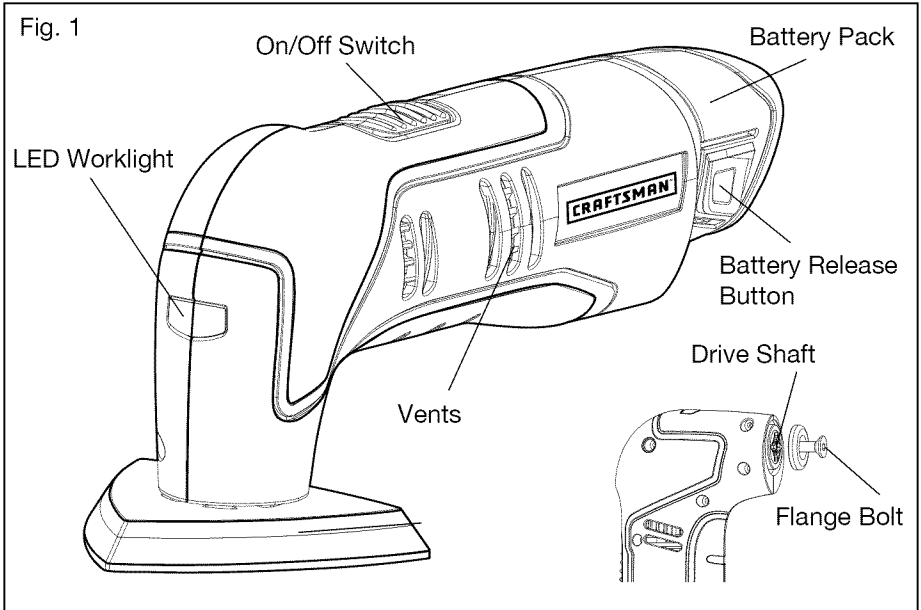

**CAUTION:** To reduce the risk of injury, charge only lithium-ion rechargeable batteries. Other types of batteries may burst, causing personal injury or damage.

**WARNING:** When using electric appliances, basic precautions should always be followed, including the following.

- a) To reduce the risk of injury, close supervision is necessary when an appliance is used near children.
- b) Only use attachments recommended or sold by manufacturer.
- c) Do not use outdoors.
- d) For a portable appliance – To reduce the risk of electrical shock, do not put the Multi-Tool and Battery Pack in water or other liquid. Do not place or store appliance where or can fall or be pulled into a tub or sink.

## DESCRIPTION

### KNOW YOUR MULTI-TOOL (Fig.1)

PRODUCT SEPCIFICATION	
Motor	12 Volt DC
Tool Weight (with battery)	1.8lbs
Oscillation Rate	15000/Min
Oscillation Angle	±1.4 degrees
Battery Type	Lithium-Ion
Battery Voltage	12 Volt DC
Charger Input	120-Volts, 60 Hz AC only
Optimum Charging Temperature	32°F (0° C) -104°F (40°C)

**⚠ WARNING:** The safe use of this product requires an understanding of the information on the tool and in this operator's manual, as well as knowledge of the project you are attempting. Before using this product, familiarize yourself with all operating features and safety rules.

## ASSEMBLY

**⚠ WARNING:** If any parts are broken or missing, do not attempt to plug in the power cord or operate the tool until the broken or missing parts are replaced. Failure to do so could result in possible serious injury.

**⚠ WARNING:** Do not attempt to modify this tool or create accessories not recommended for use with this tool. Any such alteration or modification is misuse and could result in a hazardous condition leading to possibly serious injury.

**⚠ WARNING:** To prevent accidental starting that could cause serious personal injury, always remove the battery pack from the tool when assembling parts.

## UNPACKING

This product has been shipped completely assembled.

- Carefully remove the tool and any accessories from the box. Make sure that all items listed in the packing list are included.
- Inspect the tool carefully to make sure that no breakage or damage occurred during shipping.
- Do not discard the packing material until you have carefully inspected and satisfactorily operated the tool.





- If any part is damaged or missing, please refer to the numbers listed on the back page of operator's manual.

## PACKING LIST

Multi-Tool, straight edge flush cut blade, circular saw blade, hardened steel scraping blade, carbide circular adhesive removal blade, carbide triangular rasp, sanding plate and 24 pcs sandpapers, hex key, vacuum adaptor, operator's manual.

## SELECTING THE APPLICATION ACCESSORY

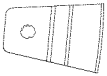
**▲ WARNING:** If any part is broken or missing, do not attempt to plug in the power cord or operate the tool until the broken or missing part is replaced. Failure to do so could result in possible serious injury.

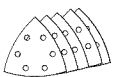
ACCESSORY		MATERIALS
	Carbide Circular Adhesive Removal Blade	Grout, Plaster, Porous Concrete and Masonry
	Carbide Triangular Rasp	Hardened adhesives, Thinset, Wood, Masonry
	Hardened Steel Scraping Blade	Paint & Varnish, Bonded Carpet, Soft Adhesives, Vinyl Flooring, wood and other floor coverings.
	Steel High-Speed Circular Saw Blade	Wood, Plastic, Drywall, Non-Ferrous Metals, thin Sheet Metal and other materials
	High Carbide Steel Straight Edge Flush Cut Blade	Wood, Plastic, Drywall, Soft Metals and other Materials
	Sanding Plate and Sandpaper	Bare or painted wood, plaster, and other surfaces, depending on sandpaper grit

## OPERATION

### LOW-BATTERY CAPACITY INDICATOR

If the LED worklight begins to rapidly and continuously flash when the switch on the tool is depressed, the battery-pack power has run out, and the battery pack should be recharged.

Unlike other battery pack types, Lithium-Ion battery packs deliver fade-free power for their entire run time. The tool will not experience a slow, gradual loss of power as you work. To signal that the battery pack is at the end of its run time and needs to be charged, the power to the tool will drop quickly.

**NOTE:** The LED may also flash due to an overload or high temperature (see

BATTERY PROTECTION).

## BATTERY PROTECTION

The battery circuitry protects the battery pack from extreme temperature, over discharge, and over-charge. To protect the battery from damage and prolong its life, the battery pack circuitry will turn off the battery pack if it becomes overloaded or if the temperature becomes too high during use. This may happen in situations involving extremely high torque, binding, and stalling. This intelligent system will shut down your battery pack if its operating temperature exceeds 176°F (80°C) and will begin normal operation when it returns to 32°F (0°C) - 122°F (50°C).

The LED worklight light will begin flash slowly if the battery circuitry detects a momentary overload.

**NOTE:** The battery can automatically reset. If the LED continues to flash rapidly, it is indicating that the charge is substantially diminished. Place the battery into the charger for charging. (See BATTERY CAPACITY INDICATOR, above.)

**NOTE:** A significantly reduced run time after fully charging the battery pack indicates that the battery is near the end of its usable life and must be replaced.

## COLD WEATHER OPERATION

This Lithium-Ion battery pack will provide optimal performance in temperatures between 32°F (0°C) and 104°F (40°C). When the battery pack is very cold, it may “pulse” for the first minute of use to warm itself. Put the battery pack on a tool and use the tool in a light application. After about a minute, the battery pack will have warmed itself and will operate normally.

## WHEN TO CHARGE THE BATTERY PACK

It is not necessary to run down the battery pack charge before recharging. The Lithium-Ion battery can be charged at any time and will not develop a “memory” when charged after only a partial discharge.

Remove the battery pack from the tool when convenient for you and your job. “Top off” the battery pack charge by charging it for a time before starting a big job or long period of use.

Due to Lithium-Ion fade-free properties, the only time it is necessary to charge the Lithium-Ion battery pack is when the pack has reached the end of its charge. To signal the end of charge, power to the tool will drop quickly. Charge the battery pack as needed.

Fig. 2

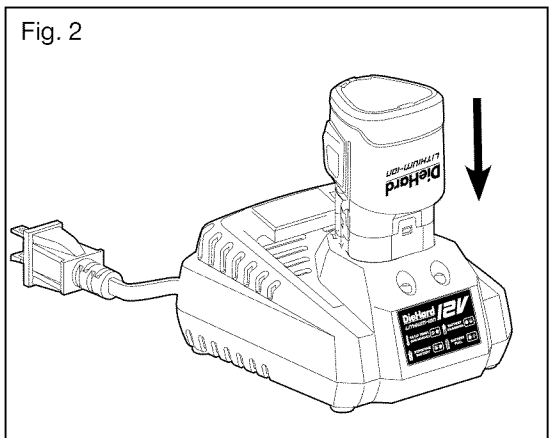

## HOW TO CHARGE THE BATTERY PACK









**NOTE:** This Lithium-Ion battery pack is shipped partially charged. Before using it the first time, fully charge the battery pack.

A fully discharged battery pack will charge in about 30 minutes in an environment between 32° F (0° C) and 104° F (40° C).

1. Charge the Lithium-Ion battery pack with the correct charger.
2. Connect the charger to a power supply.
3. Align the raised ribs of the battery pack with the slot in the charger.
4. Insert the battery pack into the charger (Fig. 2).
5. The charger will communicate with the battery pack to evaluate the condition of the battery pack.
6. The green lights will flash while the battery pack is charging. After charging is complete, the green LED on the charger will be on. The flickering red light indicates a defective battery or a bad connection between the battery and the charger.
7. The battery pack will fully charge if left on the charger, but it will not overcharge.

**NOTE:** For your convenience, the charger can operate with most generators and inverters rated at 300 watts or higher.

## LED FUNCTIONS OF CHARGER (Fig. 3)

LED INDICATOR	BATTERY PACK	RED LED	GREEN LED	ACTION
 <b>HI/LO TEMP.</b> (SEE MANUAL) 	Hot/Cold battery	On	Off	Charging will begin when battery returns to 32°F (0°C)-104°F (40°C)
 <b>DEFECTIVE BATTERY</b> 	Defective	Flashing	Off	Battery pack or Charger/Adapter is defective
 <b>BATTERY CHARGING</b> 	Charging	Off	Flashing	Charging
 <b>BATTERY FULL</b> 	Fully charged	Off	On	Charging is complete



## CHARGING A HOT BATTERY PACK

If the battery pack is above normal temperature range, the red LED will illuminate and the green LED will be off. When the battery pack cools down to approximately 104°F (40°C), the charger will automatically begin charging.

## CHARGING A COLD BATTERY PACK

If the battery pack is below the normal temperature range, the red LED will illuminate and the green LED will be off. When the battery warms to a temperature of more than 32°F (0°C), the charger will automatically begin charging.

## DEFECTIVE BATTERY

If the charger detects a problem, the red LED will begin flashing and the green LED will be off.

1. If registering as defective, remove and reinsert the battery pack in the charger. If the LED status reads “defective” a second time, try charging a different battery pack.
2. If a different battery pack charges normally, dispose of the defective battery pack (see Maintenance section).
3. If a different battery pack also indicates “defective,” the charger may be defective.

## BATTERY CHARGING

If the battery pack is being charged within a normal environmental temperature range (32 °F to 104°F), the green LED will begin flashing and the red LED will be off. The battery pack will reach a full charge in 30 minutes.

## BATTERY FULL

If the battery pack is within normal temperature range, the green LED will illuminate and the red LED will be off. The battery pack is fully charged and ready to use. The battery pack will fully charge, but will not overcharge, if left on the charger.

**NOTE:** The charger may heat up with several continuous charge cycles. This is part of the normal operation of the charge. Charge in a well ventilated area.

## TO ATTACH BATTERY PACK (Fig. 4)

1. Make sure that the tool is “OFF”
2. Align the raised rib on the battery pack with the grooves in the tool, and then attach the battery pack.

**NOTE:** Make sure that the latch on the battery pack snaps into place and that the battery pack is secured to the tool before beginning operation.

## TO DETACH BATTERY PACK (Fig. 4)

1. Make sure that the tool is "OFF"
2. Depress the battery release buttons located on the both sides of th of the battery pack to release the battery pack.
3. Pull the battery pack out and remove it from the tool.

**⚠ CAUTION:** When placing the battery pack in the tool, be sure that the raised rib on battery pack aligns with the groove inside the tool and that the latches snap into place properly. Improper assembly of the battery pack can cause damage to internal components.

**⚠ WARNING:** Battery tools are always in operating condition; therefore, the direction-of-rotation selector should always be locked when not in use or carrying the tool at your side.

## ON/OFF SWITCH (Fig. 5)

To turn the tool ON, push the on/off switch forward. To turn it OFF, push the switch backward.

## LED WORKLIGHT (Fig. 6)

The LED worklight, located on the front of the tool, will illuminate when the on/off switch is in the forward (ON) position. This provides additional light on the surface of the workpiece for operation in lower-light conditions. The LED worklight will turn off when the switch is slid backwards (OFF).

Fig. 4

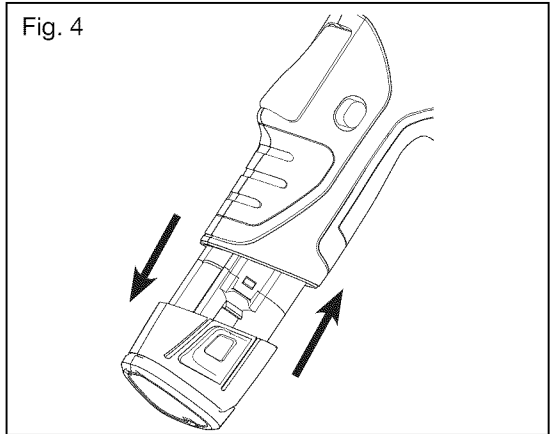

Fig. 5

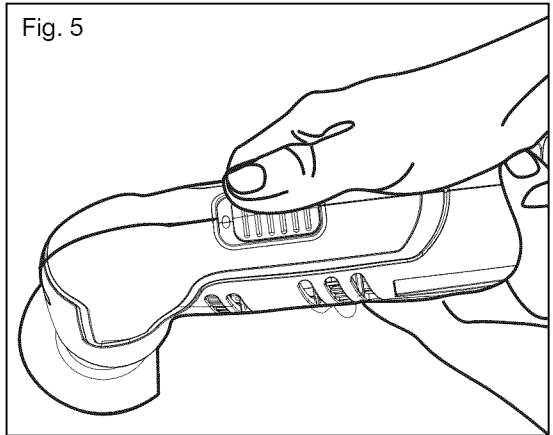
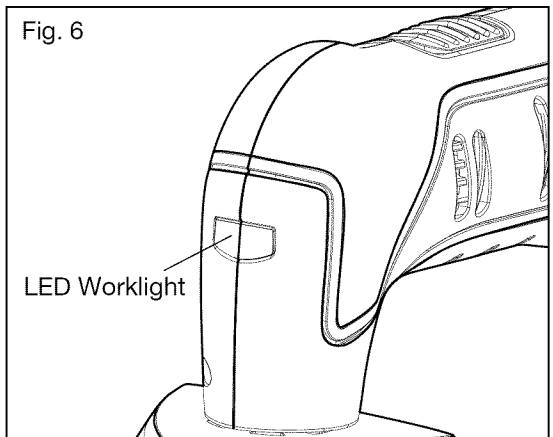

Fig. 6



## DETACHABLE VACUUM ADAPTOR (Fig.7)

Always connect the vacuum adaptor when sanding.

Remove the application tool before mounting the vacuum adaptor. To improve dust extraction from the working area, insert the dust-extraction adaptor into the rear of the tool, and connect the adaptor to a dust-extraction system or a suitable vacuum cleaner.

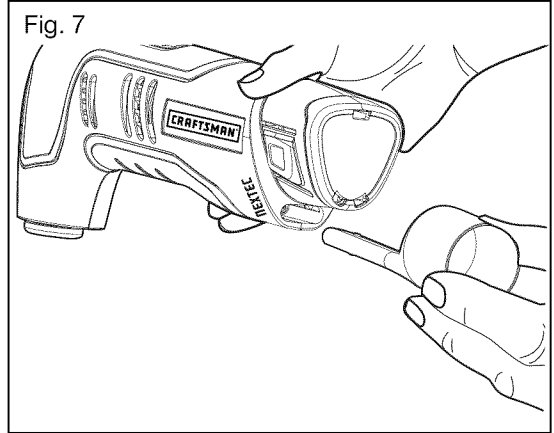

## ATTACHING THE APPLICATION TOOL (FIG. 8, 9, 10, 11)

**⚠ WARNING:** Failure to remove the battery pack from the tool when assembling parts, making adjustments, or changing accessories could result in accidental starting causing possibly serious injury.

**⚠ CAUTION:** For all work or when changing application tools, always wear protective gloves. The sharp edges of the application tools will cause personal injury. Application tools can be very hot while working.

**⚠ WARNING:** Check that the application tools are correctly attached. Incorrect or insecurely fastened application tools can come loose during operation and cause a hazard.

**⚠ WARNING:** Do not attach the circular saw blade or the straight edge cutting blade facing backwards (Fig. 8), as operation in this position may cause serious injury.

1. Remove the battery pack from the Multi-Tool.
2. Loosen the flange bolt with the hex key provided. (Fig. 9)
3. Ensure that the inner threads and the drive shaft are clean.
4. Align the grooves on the application tool with the four raised ribs on the drive shaft; put the application tool onto the drive shaft. (Fig.10)
5. With your gloved hand holding the blade, put on and tighten the flange bolt using the hex key.

**NOTE:** Attach the application tool at the desired orientation for the task at hand. The shaft is configured so that the application tool can be attached every 30° around the shaft, from 0° to 330° (Fig. 11).

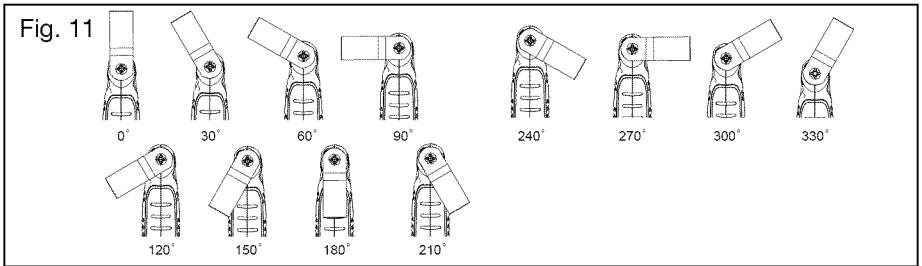
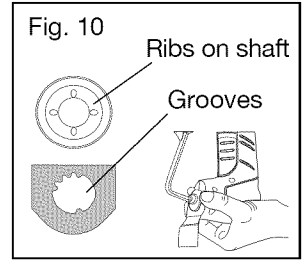
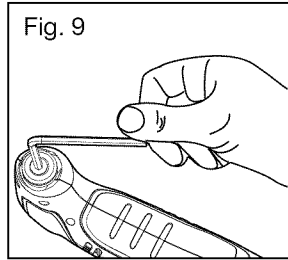
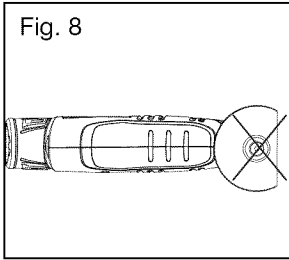

## MOUNTING/CHANGING THE SANDPAPER (Fig.12)

**⚠ WARNING:** Failure to remove the battery pack from the tool when assembling parts, making adjustments, or changing accessories could result in accidental starting causing possibly serious injury.

1. Follow the directions for Attaching the Application Tool to attach the sanding plate to the Multi-Tool.
2. Align the sandpaper with the sanding plate and use your hand to press it firmly on the sanding plate.
3. Press the sandpaper firmly against a smooth surface for a short period, then switch on the tool. The burr will form a non-slip bond with the outer edge of the sandpaper felt. This will avoid premature wear.
4. If one point has become worn, pull off the sandpaper, turn it 120° and place it on the sanding plate again.

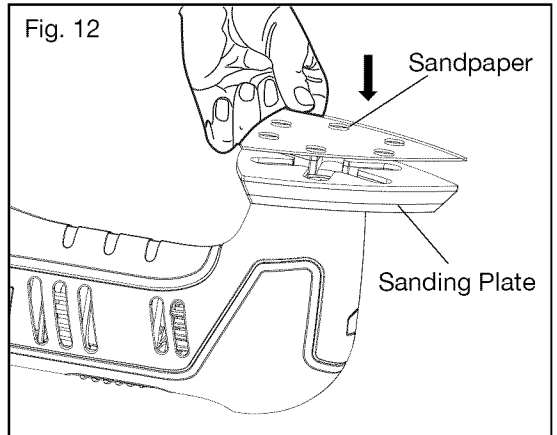

## SAWING

**⚠ WARNING:** Use sharp, undamaged saw blades only. Deformed, blunt saw blades or saw blades that are otherwise damaged can break.

**⚠ WARNING:** When sawing light building materials, observe the statutory provisions and the recommendations of the material suppliers.

**⚠ WARNING:** Plunge cuts may only be applied to soft materials, such as wood, gypsum plaster boards, etc.

**⚠ WARNING:** The sawing teeth are very sharp. Do not touch during mounting and application.

To cut and remove damaged portions of plasterboard:

Make two sets of parallel cuts on around the the damaged section. Then use a chisel (available separately) to break out the piece between the cuts.

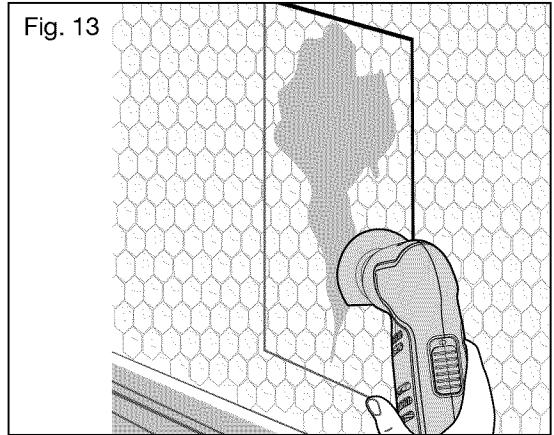

## SEPARATING

The Carbide Circular Adhesive Removal Blade is designed to cut out the grout around wall tiles. It can also be used to cut plaster, porous concrete and masonry.

Put the Carbide Circular Adhesive Removal Blade on the cutting surface at 90° to the workpiece, switch the tool on, and apply with appropriate pressure (Fig. 14).

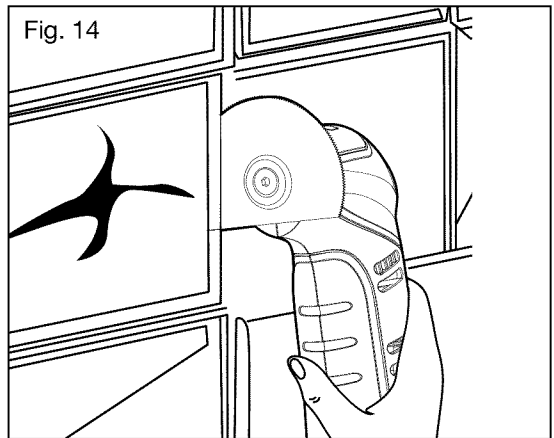

**NOTE:** When separating wall tiles, take into consideration that the application tools/accessories wear heavily when used for longer periods of time.

## **SANDING**

**WARNING:** Do not touch the gear box after prolonged use; it could be very hot.

- The removal rate and the sanding pattern are determined by the choice of sanding sheet and the work surface.
  - Apply uniform sanding pressure to extend the life of the sanding sheets.
  - Intensifying the sanding pressure does not lead to an increase of the sanding capacity, but instead it increases wear on the machine and the sanding sheet.
  - Use only the tip or an edge of the sanding sheet for precise sanding of edges, corners and hard to reach areas.
  - When selectively sanding on one spot, the sanding sheet can heat up considerably. Remove the tool from the surface periodically to permit the sanding sheet to cool down.
  - A sanding sheet that has been used for metal should not be used for other materials.
  - Use only original Sears sanding accessories. For sanding, always connect dust extraction.
1. For Rough sanding use 40-80 grit paper
  2. For Smooth sanding use 120-180 grit

## **paperSCRAPING**

Use the Scraping Blade to:

- remove paint, coatings and vinyl on wood, and other floor coverings
- scrape off adhesive residue
- cut carpet

To cut and remove carpet, place the Scraping Blade vertically on the workpiece, switch the tool on, and cut the carpet, then put the tool on the workpiece at a flat angle (not over 20°), and apply only light pressure. Otherwise the scraper can cut into the surface beneath the carpet.

## APPLICATION

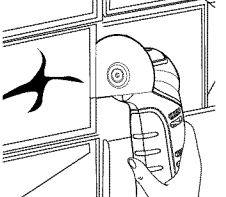
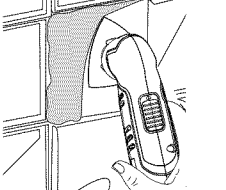
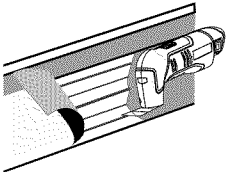
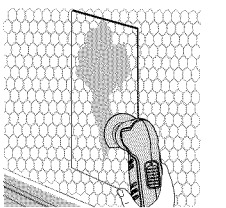
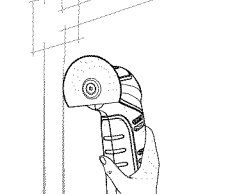
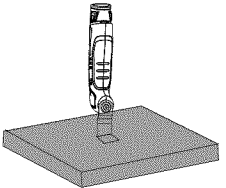
ACCESSORY		APPLICATION
	<p>Carbide Circular Adhesive Removal Blade</p>	<p>Cut out the grout around tile</p>
	<p>Carbide Triangular Rasp</p>	<p>Remove tile adhesive residue</p>
	<p>Hardened Steel Scraping Blade</p>	<p>Remove floor coverings and scrape off adhesive residue</p>
	<p>High Speed Steel Circular Saw Blade</p>	<p>Cut and remove the damaged part of plasterboard</p>
		<p>First make two parallel cuts, then break out the piece in between with chisel and sinker to lay the cable and plaster over</p>
	<p>High Carbide steel Straight Edge Flush Cut Blade</p>	<p>Plunging and sawing with a slight rocking motion in wood , plasterboard and soft plastics</p>
	<p>Sanding Plate and Sandpaper</p>	<ol style="list-style-type: none"> <li>1. Rough sanding using grit size 40-80</li> <li>2. Smooth sanding using grit size 120-180</li> </ol>

## MAINTENANCE

**⚠ WARNING:** To avoid serious personal injury, always remove the battery pack from the tool when cleaning or performing any maintenance.

**⚠ WARNING:** When servicing, use only identical Craftsman replacement parts. Use of any other parts may create a hazard or cause product damage.

**⚠ WARNING:** It is not recommended to use compressed dry air as cleaning method of the tool. If cleaning with compressed air is the only method to apply, always wear safety goggles or safety glasses with side shields when using compressed air to clean the tool. If the operation is dusty, also wear a dust mask.

### GENERAL MAINTENANCE

Avoid using solvents when cleaning plastic parts. Most plastics are susceptible to damage from various types of commercial solvents and may be damaged by their use. Use clean cloths to remove dirt, dust, oil, grease, etc.

**⚠ WARNING:** Do not at any time let brake fluids, gasoline, petroleum-based products, penetrating oils, etc. to come in contact with plastic parts. Chemicals can damage, weaken or destroy plastic which may result in serious personal injury.

**⚠ WARNING:** When servicing, use only identical Craftsman replacement parts. Use of any other parts may create a hazard or cause product damage. To ensure safety and reliability, all repairs should be performed by a qualified service technician at a Sears Service Center.

### BATTERIES:

The battery pack is equipped with Lithium-Ion rechargeable batteries. The duration of use from each charge will depend on the type of work performed.

The batteries in this tool have been designed to provide maximum trouble-free life. Like all batteries, they will eventually wear out. Do not disassemble the battery pack or attempt to replace the batteries. Handling of the batteries, especially when wearing rings and jewelry, could result in a serious burn.

To obtain the longest possible battery life, read and understand the operator's manual.

- It is good practice to unplug the Charger/Adaptor and remove the Lithium-Ion battery pack when not in use.

For Lithium-Ion battery pack storage longer than 30 days:

- Store the Lithium-Ion battery pack where the temperature is below 80°F





(26°C) and free of moisture.

- Store Lithium-Ion battery packs in a 30%-50% charged condition.
- Every six months of storage, fully charge the Lithium-Ion battery pack.
- Exterior may be cleaned with a cloth or soft non-metallic brush.

## **BATTERY PACK REMOVAL AND PREPARATION FOR RECYCLING**

To preserve natural resources, please recycle or dispose of batteries properly. This product contains lithium-ion batteries. Local, state, or federal laws may prohibit disposal of lithium-ion batteries in ordinary trash. Consult your local waste authority for information regarding available recycling and/or disposal options.

**⚠ WARNING:** Upon removal of the battery pack for disposal or recycling, cover the battery pack's terminals with heavy-duty adhesive tape. Do not attempt to destroy or disassemble battery pack or remove any of its components. Lithium-Ion batteries must be recycled or disposed of properly. Also, never touch both terminals with metal objects and/or body parts as short circuit may result. Keep away from children. Failure to comply with these warnings could result in fire and/or serious injury.

## TROUBLESHOOTING

<b>PROBLEM</b>	<b>CAUSE</b>	<b>SOLUTION</b>
The tool does not work	Battery is depleted	Charge the battery
Motor overheating	Be sure cooling vents are free from dust and obstacles	Clean, clear vents. Do not cover with hand during operation

# PARTS LIST

## 12 VOLT LITHIUM-ION CORDLESS MULTI-TOOL MODEL NUMBER 320.61199

The Model Number will be found on the Nameplate attached to the handle of the Multi-Tool. Always mention the Model Number when ordering parts for this tool.

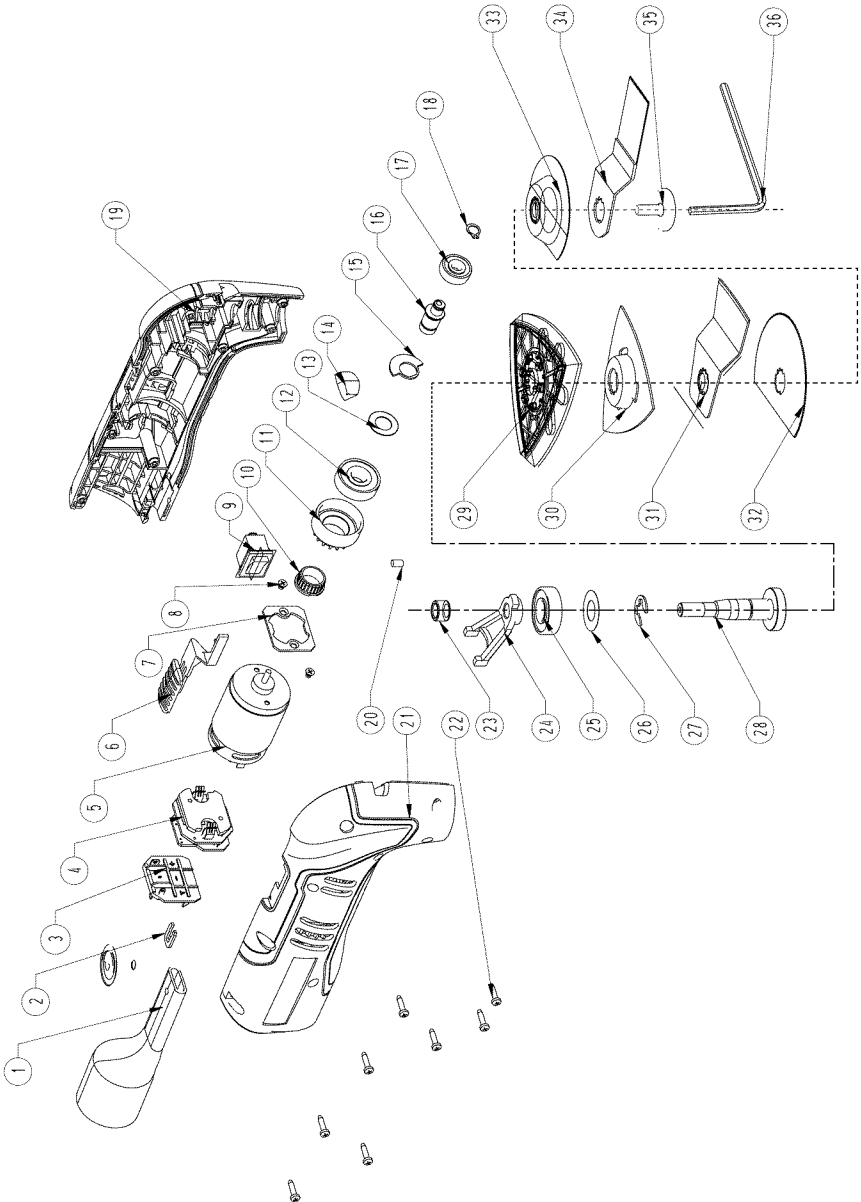





# Get it fixed, at your home or ours!

## Your Home

For expert troubleshooting and home solutions advice:

**manage my home**

[www.managemyhome.com](http://www.managemyhome.com)

For repair – **in your home** – of **all** major brand appliances, lawn and garden equipment, or heating and cooling systems, **no matter who made it, no matter who sold it!**

For the replacement parts, accessories and owner's manuals that you need to do-it-yourself.

For Sears professional installation of home appliances and items like garage door openers and water heaters.

**1-800-4-MY-HOME<sup>®</sup>**

(1-800-469-4663)

[www.sears.com](http://www.sears.com)

Call anytime, day or night

(U.S.A. and Canada)

[www.sears.ca](http://www.sears.ca)

## Our Home

For repair of carry-in items like vacuums, lawn equipment, and electronics, call anytime for the location of the nearest **Sears Parts & Repair Service Center**

**1-800-488-1222** (U.S.A.)

[www.sears.com](http://www.sears.com)

**1-800-469-4663** (Canada)

[www.sears.ca](http://www.sears.ca)

To purchase a protection agreement on a product serviced by Sears:

**1-800-827-6655** (U.S.A.)

**1-800-361-6665** (Canada)

Para pedir servicio de reparación a domicilio, y para ordenar piezas:

**1-888-SU-HOGAR<sup>®</sup>**

(1-888-784-6427)

Au Canada pour service en français:

**1-800-LE-FOYER<sup>MC</sup>**

(1-800-533-6937)

[www.sears.ca](http://www.sears.ca)

**Sears**

© Sears Brands, LLC

<sup>®</sup> Registered Trademark / <sup>™</sup> Trademark / <sup>SM</sup> Service Mark of Sears Brands, LLC

<sup>®</sup> Marca Registrada / <sup>™</sup> Marca de Fábrica / <sup>SM</sup> Marca de Servicio de Sears Brands, LLC

<sup>MC</sup> Marque de commerce / <sup>MD</sup> Marque déposée de Sears Brands, LLC

## Free Manuals Download Website

<http://myh66.com>

<http://usermanuals.us>

<http://www.somanuals.com>

<http://www.4manuals.cc>

<http://www.manual-lib.com>

<http://www.404manual.com>

<http://www.luxmanual.com>

<http://aubethermostatmanual.com>

Golf course search by state

<http://golfingnear.com>

Email search by domain

<http://emailbydomain.com>

Auto manuals search

<http://auto.somanuals.com>

TV manuals search

<http://tv.somanuals.com>