

Operator's Manual

CRAFTSMAN®

7-in. Tile Wet Saw with LASER TRAC™

Model No.
118.22000



CAUTION: Read, understand and follow all Safety Rules and Operating Instructions in this Manual before using this product.

- WARRANTY
- SAFETY
- ASSEMBLY
- OPERATION
- MAINTENANCE

Sears, Roebuck and Co., Hoffman Estates, IL 60179 U.S.A.

Visit our Craftsman web site: www.sears.com/craftsman

TABLE OF CONTENTS

Warranty.....	Page 2
Safety Symbols.....	Page 3
Safety Instructions.....	Pages 3-11
Description.....	Page 12
Unpacking.....	Pages 13-14
Assembly.....	Pages 15-16
Operation.....	Pages 17-18
Maintenance.....	Pages 18-20
Troubleshooting.....	Page 21
Accessories.....	Page 21
Repair Parts.....	Pages
Sears Repair Parts Phone Numbers.....	Back Cover

ONE YEAR FULL WARRANTY ON CRAFTSMAN PRODUCT

If this Craftsman product fails due to a defect in material or workmanship within one year from the date of purchase, **RETURN IT TO THE NEAREST SEARS STORE OR PARTS AND REPAIR CENTER OR OTHER CRAFTSMAN OUTLET IN THE UNITED STATES FOR FREE REPAIR.**

This warranty does not include expendable parts such as lamps, batteries, bits or blades.

If this Craftsman Tool is used for commercial or rental purposes, this warranty applies for only 90 days from the date of purchase.

This warranty gives you specific legal rights, and you may also have other rights which vary from state to state.

Sears, Roebuck and Co., Hoffman Estates, IL 60179

**SAVE THESE INSTRUCTIONS!
READ ALL INSTRUCTIONS!**

SAFETY SYMBOLS

The purpose of safety symbols is to attract your attention to possible dangers. The safety symbols, and the explanations with them, deserve your **careful attention and understanding**. The symbol warnings **DO NOT** by themselves eliminate any danger. The instructions and warnings they give are no substitutes for proper accident prevention measures.

⚠ WARNING: BE SURE to read and understand all safety instructions in this manual, including all safety alert symbols such as "DANGER", "WARNING" and "CAUTION", BEFORE using this saw. Failure to follow all instructions listed below may result in electric shock, fire and/or serious personal injury.

SYMBOL MEANING

⚠ SAFETY ALERT SYMBOL: Indicates DANGER, WARNING, OR CAUTION. May be used in conjunction with other symbols or pictographs

⚠ DANGER Failure to obey this safety warning **WILL** result in death or serious injury to yourself or to others. Always follow the safety precautions to reduce the risk of fire, electric shock and personal injury.

⚠ WARNING Failure to obey this safety warning **CAN** result in death or serious injury to yourself or to others. Always follow the safety precautions to reduce the risk of fire, electric shock and personal injury.

⚠ CAUTION Failure to obey this safety warning **MAY** result in personal injury to yourself or others or property damage. Always follow the safety precautions to reduce the risk of fire, electric shock and personal injury.

DAMAGE PREVENTION AND INFORMATION MESSAGES

These inform user of **important information and/or instructions** that could lead to equipment or other property damage if not followed. Each message is preceded by the word **"NOTE:"** as in the example below:

NOTE: Equipment and/or property damage may result if these instructions are not followed.







⚠ WARNING: The operation of any tool with a circular blade can result in foreign objects being thrown into your eyes, which can result in severe eye damage. Before beginning power tool operation, **ALWAYS** wear safety goggles or safety glasses with side shield and a full-face shield when needed. We recommend a Wide Vision Safety Mask for use over eyeglasses or standard safety glasses with side shield, available at Sears Stores or other Craftsman Outlets.

SAFETY SYMBOLS cont.

HAZARD SYMBOLS

Some of the following symbols may be used on this tool. Please study them and learn their meaning. Proper interpretation of these symbols will allow you to operate the tool better and safer.

SYMBOL	NAME	DESIGNATION/EXPLANATION
	No Hands Symbol	Failure to keep your hands away from the blade will result in serious personal injury.
	No Hands Symbol	Failure to keep your hands away from the blade will result in serious personal injury.
	Eye Protection	Always wear safety goggles or safety glasses with side shields and a full face shield when operating this product.
	Hearing Protection	Always wear hearing protection when operating this product.
	Hand Protection	Always wear work gloves when operating this product.

SAFETY INSTRUCTIONS

SAFETY PRECAUTIONS FOR LASERS

This **CRAFTSMAN 7-in. Tile Wet Saw** has a built-in laser light. The laser is a Class IIIa and emits output power of a maximum 2.5mW and 650nm wavelengths. These lasers do not normally present an optical hazard. However, **DO NOT** stare at the beam as this can cause flash blindness.

CAUTION: The following label is on your tool. It indicates where the laser light is emitted by the saw. **ALWAYS MAKE SURE** that any bystanders in the vicinity of use are made aware of the dangers of looking directly into the laser.



⚠ WARNING: LASER LIGHT. LASER RADIATION. Avoid Direct Eye Exposure. DO NOT stare into beam. Only turn laser beam on when using the tile saw.

⚠ WARNING: Use of controls, adjustments or performance of procedures other than those specified in this manual may result in hazardous radiation exposure.

⚠ WARNING: The use of optical instruments such as, but not limited to, telescopes or transits to view the laser beam will increase eye hazard.

SAFETY INSTRUCTIONS cont.

SAFETY PRECAUTIONS FOR LASERS cont.

1. The laser beam system is mounted to the blade guard. Never remove from blade guard to use on another tool or use for other purposes.
2. The laser beam can be harmful to the eyes. **ALWAYS** avoid direct eye exposure. **DO NOT** look directly into the laser beam output aperture during operation.
3. The laser on the tile saw is not a toy. **ALWAYS** keep out of the reach of children. The laser light emitted from this device **SHOULD NEVER** be directed towards any person for any reason.
4. Be aware that laser light reflected off of a mirror or any other reflective surfaces can also be dangerous.

WORK AREA SAFETY

1. **Keep your work area clean and well lit. DO NOT** leave tools or tile pieces on on the saw while it is in operation. Cluttered work benches and dark areas invite accidents.
2. **DO NOT operate power tools in explosive atmospheres, such as in the presence of flammable liquids, gases, or dust.** Power tools create sparks which may ignite the dust or fumes.
3. **Keep bystanders, children and visitors away while operating a power tool.** Distractions can cause you to lose control.
4. **Make your workshop childproof** with padlocks and master switches, or by removing tab in the middle of starter switch (See Fig. 26 on page 16).
5. **MAKE SURE the work area has ample lighting** so you can see the work and that there are no obstructions that will interfere with safe operation **BEFORE** using your saw.

PERSONAL SAFETY

1. **KNOW your power tool.** Read the operator's manual carefully. Learn the saw's applications and limitations, as well as the specific potential hazards related to this tool.
2. **STAY ALERT,** watch what you are doing and use common sense when operating a power tool.
3. **DO NOT** use tool while tired or under the influence of drugs, alcohol or medication. A moment of inattention while operating power tools may result in serious personal injury.
4. **DRESS properly. DO NOT** wear loose clothing or jewelry. Pull back long hair. Keep your hair, clothing, and gloves away from moving parts. Loose clothing or long hair can be caught in moving parts. Air vents often cover moving parts and should also be avoided.
5. **AVOID** accidental starting. **BE SURE switch is in the "OFF" position before plugging in.**
6. **REMOVE** adjusting keys or wrenches before turning the tool **"ON"**. A wrench or a key that is left attached to a rotating part of the tool may result in personal injury.
7. **DO NOT** overreach. **KEEP proper footing and balance at all times.** Proper footing and balance enables better control of the tool in unexpected situations.
8. **USE SAFETY EQUIPMENT. ALWAYS** wear eye protection. Dust mask, non-skid safety shoes, hard hat, or hearing protection must be used for appropriate conditions.
9. **NEVER stand on tool.** Serious injury could occur if the tool is tipped or if the blade is accidentally contacted.

SAFETY INSTRUCTIONS cont.

TOOL USE AND CARE SAFETY

⚠ WARNING: BE SURE to read and understand all instructions before operating this saw. Failure to follow all instructions listed below may result in electric shock, fire and/or serious personal injury.

1. **BE SURE** the splash guard is intact and in good condition.
2. **DO NOT** wash or allow water to come in direct contact with the bottom of the motor.
3. **NEVER** leave the tool running unattended. **ALWAYS** turn it off. **DO NOT** leave until the tool comes to a complete stop.
4. **DO NOT** force the tool. Slowly and smoothly pull the blade assembly as you cut through the tile. **Use the correct tool for your application.** The correct tool will do the job better, safer, and at the rate for which it is designed.
5. **DO NOT** use the tool if the switch does not turn it "ON" or "OFF". Any tool that cannot be controlled with the switch is **dangerous** and must be repaired.
6. **DISCONNECT** the plug from the power source before making any adjustments, changing accessories or storing the tool. Such preventive safety measures reduce the risk of starting the tool accidentally.
7. **KEEP** blade guards in place and in good working order.
8. **DO NOT** use in dangerous environments. **DO NOT** use in damp or wet locations, or expose to rain.
9. **STORE** idle tools out of the reach of children and other untrained persons. Tools are dangerous in the hands of untrained users.
10. **MAINTAIN** tools with care. **Keep cutting tools sharp and clean.** Properly maintained tools with sharp cutting edges are less likely to bind and are easier to control.
11. **BEFORE** using this saw, **CHECK** for damaged parts, including guards for proper operation and performance, misalignment or binding of moving parts, breakage of parts, or any other condition that may affect the tool's operation. **If damaged**, have the tool serviced before using. Many accidents are caused by poorly maintained tools.
12. **USE ONLY** accessories that are recommended for this tool. Accessories that may be suitable for one tool may become hazardous when used on another tool.

⚠ CAUTION: Use of accessories that are not recommended for use with this tool may create a hazardous condition.

ELECTRICAL SAFETY AND GROUNDING INSTRUCTIONS

⚠ CAUTION: ALWAYS use a GFCI (Ground Fault Circuit Interrupter) protected receptacle since the blade of this saw is used in close proximity to water.

1. This tool is equipped with an electrical cord having a 3-prong electrical plug (Fig. 1-A). **DO NOT** alter the plug or use in a 2-prong receptacle. **DO NOT** modify the plug provided. If it will not fit the outlet, have the proper outlet installed by a qualified electrician.

SAFETY INSTRUCTIONS cont.

ELECTRICAL SAFETY AND GROUNDING INSTRUCTIONS cont.

2. Grounded corded tools are intended for use on supply circuits having a nominal rating of less than 150 volts. The plug may not fit your outlet.
3. In the event of a malfunction or breakdown, grounding provides a path of least resistance for electric current to reduce the risk of electric shock.
4. This tool is equipped with an electric cord having an equipment-grounding conductor and a grounding plug (Fig.1-A). The plug must be plugged into a GFCI protected matching outlet that is properly installed and grounded in accordance with all local codes and ordinances.

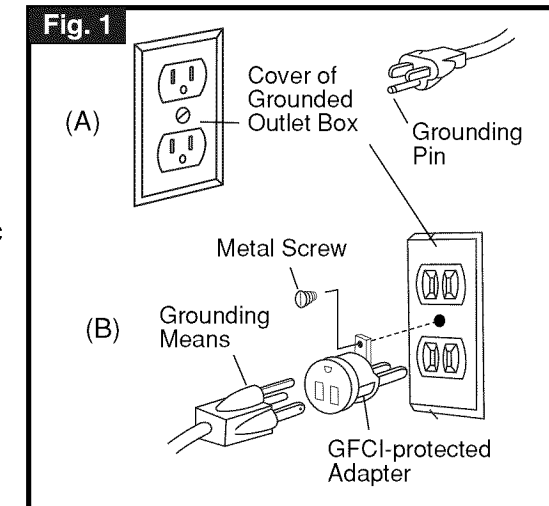

5. Your local electrical code may require a slightly different plug connection. **IF** these differences exist, refer to and make the proper adjustments per your local code **BEFORE** your tool is plugged in and turned on.
6. A temporary GFCI protected adapter may be used to connect this plug to a 2-prong outlet if a properly grounded 3-prong outlet is not available (Fig.1-B).
7. The temporary equipment grounding adapter **SHOULD ONLY BE** used until a properly grounded 3-prong outlet can be installed by a qualified electrician.
8. The green colored rigid ear or lug extending from the adapter (Fig. 1-B) is the equipment grounding conductor and **MUST** be connected to a permanent ground, such as a properly grounded outlet box.
9. If repair or replacement of the electric cord or plug is necessary, **DO NOT** connect the equipment grounding adapter to a live terminal.
10. Repair or replace damaged or worn cord immediately.

NOTE: If you do not fully understand the grounding instructions or if you are in doubt as to whether the tool is properly grounded, check with a qualified electrician or service person.

⚠ WARNING: Do not permit fingers to touch the terminal or plug when installing or removing the plug from an outlet.

⚠ WARNING: If not properly grounded and GFCI protected, this tool can cause an electrical shock, particularly when used in damp locations, in proximity to plumbing, or out of doors. If an electrical shock occurs there is the potential of a secondary hazard, such as your hands contacting the saw blade.

SAFETY INSTRUCTIONS cont.

EXTENSION CORDS

1. **USE ONLY** 3-wire extension cords that have 3-prong grounding plugs and 3-pole receptacles that will accept the tool's plug.
2. **Use a proper extension cord. ONLY** use cords listed by Underwriters Laboratories (UL). Other extension cords can cause a drop in line voltage, resulting in a loss of power and overheating of tool. For this tool, an AWG (American Wire Gauge) size of a least 14-gauge is recommended for an extension cord of 25- ft. or less in length. Use 12-gauge for extension cords of 50-ft. **Extension cords 100-ft. or longer are not recommended.** Remember, **a smaller wire gauge size has greater capacity than a larger number** (12-gauge wire has more capacity than 14-gauge). When in doubt use the smaller number. When operating a power tool outdoors, use an outdoor extension cord marked "W-A" or "W". These cords are rated for outdoor use and reduce the risk of electric shock.
3. **AVOID** the possibility of getting the plug or receptacle wet (Fig. 2.)
4. Have damaged tool cords repaired at **Sears Service Center**.

⚠ WARNING: Check extension cords before each use. If damaged replace immediately. Never use tool with a damaged cord since touching the damaged area could cause electrical shock, resulting in serious injury.

⚠ CAUTION: DO NOT ABUSE the cord. NEVER use the cord to pull the plug from the outlet. Keep cord away from heat, oil, sharp edges or moving parts. Replace damaged cords immediately. Damaged cords increase the risk of electric shock.

⚠ WARNING: When plugging your tile saw into an electrical outlet, always arrange a drip loop on the power cord.

1. To avoid the possibility of the appliance plug or receptacle getting wet, place the tile saw near a wall-mounted receptacle.
2. Arrange a drip loop (Fig. 2) so that part of the cord is below the receptacle, or the connector if an extension cord is used. Water will drip from the low point of the loop. This will prevent water from traveling along the cord to the receptacle or connector.
3. If the plug or receptacle does get wet, **DO NOT** un-plug the cord. Disconnect the fuse or circuit breaker that is supplying power to the tool. Then unplug and examine to see if water is present in the receptacle. Receptacle **MUST** be dry to use.
4. If the plug or receptacle does get wet, **DISCONNECT THE FUSE OR CIRCUIT BREAKER** that is supplying power to the tool **BEFORE** unplugging the cord. **AFTER DISCONNECTING THE CIRCUIT BREAKER**, you can then unplug the cord.

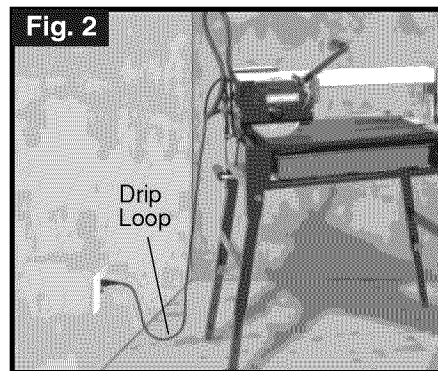

SAFETY SYMBOLS FOR YOUR TOOL

The label on your tool may include the following symbols.

V.....	Volts
A.....	Amps
Hz.....	Hertz
W.....	Watts
min.....	Minutes
~	Alternating current
—	Direct current
n _o	No-load speed
□	Class II construction
.../min.....	Revolutions or Strokes per minute
⚠.....	Indicates danger, warning caution. It means attention! Your safety is involved.

SAFETY INSTRUCTIONS cont.

SERVICE SAFETY

1. **If any part of this saw is missing or should break, bend, or fail in any way; or should any electrical component fail to perform properly: SHUT OFF** the power switch and remove the saw plug from the power source and have the missing, damaged or failed parts replaced **BEFORE** resuming operation.
2. **Tool service must be performed only at a Sears Parts and Repair Center.** Service or maintenance performed by unqualified personnel could result in a risk of injury.
3. **When servicing a tool, use only identical replacement parts. Follow instructions in the maintenance section of this manual.** Use of unauthorized parts or failure to follow maintenance instructions may create a risk of electric shock or injury.

SAFETY RULES FOR TILE WET SAWS

⚠ DANGER: Keep hands away from cutting area and blade.

1. **KNOW** your power tool. Read operator's manual carefully. Learn the applications and limitations, as well as the specific potential hazards related to this tool. Following this rule will reduce the risk of electric shock, fire or serious injury.
2. **CHECK** for damaged parts before using tool. Check moving parts for **proper alignment or binding. Check for broken parts and mountings** and all other conditions that may affect the operation of the power tool.
3. **KEEP** your body positioned to either side of the saw blade and not in direct line with the saw blade.
4. **LET** the blade reach full speed before beginning the cut.
5. **DO NOT reach underneath the work.** The guard cannot protect you from the blade beneath the work.

SAFETY INSTRUCTIONS cont.

SAFETY RULES FOR TILE WET SAWS cont.

6. **NEVER** try to cut freehand. Make sure that the tile to be cut is pressed firmly against the rip fence.
7. **NEVER** cut pieces too small to be held securely against the fence without leaving enough space for your hand to be a safe distance from the blade.
8. **NEVER** cut more than one tile at a time.
9. **KEEP the saw table free of clutter** with the exception of the tile you are cutting.
10. **MAKE SURE** that the work piece that will be cut off has enough room to move sideways. Failure to do so may result in the off-cut binding against the blade.
11. **BEFORE** cutting a tile piece, let the saw blade run freely for a few seconds. If it makes an unfamiliar sound or vibrates excessively, switch it off immediately and disconnect from the power supply.
12. **PULL blade/cutting assembly slowly and smoothly through the tile being cut. NEVER** leave the tool running unattended. Turn power off.
13. **LET** the blade come to a complete stop before removing any jammed or off-cut material from around the blade area.
14. **KEEP** the water tray topped off with water at the correct level. Allowing the blade to run dry may cause the diamond blade to overheat.
15. **ALWAYS** wear protective gloves when handling the blade or any accessories. Blades and accessories may be hot after prolonged use.

ADDITIONAL RULES FOR SAFE OPERATION

⚠ WARNING: BE SURE to read and understand all instructions. Failure to follow all instructions listed below may result in electric shock, fire and/or serious personal injury.

1. **KNOW your power tool. Read the operator's manual carefully.** Learn the applications and limitations, as well as the specific potential hazards related to this tool. Following this rule will reduce the risk of electric shock, fire or serious injury.
2. **WEAR SAFETY glasses or eye shields when using this saw.** Everyday eyeglasses have only impact-resistant lenses; they **ARE NOT** safety glasses.
3. **PROTECT your lungs.** Wear a face mask or dust mask if the operation is dusty.
4. **PROTECT your hearing.** Wear appropriate personal hearing protection during use. Under some conditions and duration of use, noise from this product may contribute to hearing loss.
5. **ALL VISTORS AND BYSTANDERS MUST** wear the same safety equipment that the operator of the saw wears.
6. **INSPECT the tool cords periodically and if damaged have them repaired at your nearest Sears Service Center or other Authorized Service Facility.**
7. **ALWAYS check the tool for damaged parts.** Before further use of the tool, a guard or other part that is damaged should be carefully checked to determine if it will operate properly and perform its intended function.

SAFETY INSTRUCTIONS cont.

ADDITIONAL RULES FOR SAFE OPERATION cont.

8. **DO NOT abuse the cord, NEVER use the cord to carry the tool or pull the plug from the outlet. Keep cord away from heat, oil, sharp edges or moving parts. Replace damaged cord immediately.** Damaged cords increase the risk of electric shock.
9. **SAVE THESE INSTRUCTIONS.** Refer to them frequently and use them to instruct others who may use this tool. **If someone borrows this tool be sure to provide them with this owner's manual.**

⚠ WARNING: Some dust particles created by power sanding, sawing, grinding, drilling and other construction jobs contain chemicals known to cause cancer, birth defects or other reproductive harm. Some examples of these chemicals are:

- Lead from lead-based paints.
- Crystalline silica from bricks and cement and other masonry products.
- Arsenic and chromium from chemically-treated lumber.

Your risk from these exposures varies, depending upon how often you do this type of work. To reduce your exposure to these chemicals:

- Work in a well-ventilated area.
- Work with approved safety equipment, such as those dust masks that are specially designed to filter out microscopic particles.

DESCRIPTION

PRODUCT SPECIFICATIONS

Rating	120V, 60 Hz AC
Input	6.7 Amps
Output	1 ¹ / ₁₅ -Peak HP
No-Load Speed	3550 rpm
Blade Diameter	7-in. (33 mm)
Depth Of Cut	1-in.
Outer Dimensions	(LWH) 37 ⁹ / ₁₀ -in. X 17 ¹ / ₂ -in. X 44 ¹ / ₂ -in.
Net Weight	76 LBS.

NOTE: Before attempting to use any tool, be sure to familiarize yourself with all the operating features and safety instructions.

⚠ WARNING: DO NOT let familiarity with your saw make you careless. Remember that a careless fraction of a second is sufficient to cause severe injury.

DESCRIPTION cont.

KNOW YOUR SAW (Fig. 3)

Your tile wet saw has a precision-built electric motor and it should only be connected to a 120-volt, 60Hz AC ONLY power supply (normal household current). DO NOT operate on direct current (DC). The large voltage drop would cause a loss of power and the motor would overheat. If the saw does not operate when plugged into the correct 120-volt, 60-Hz AC ONLY outlet, check the power supply.

This Tile Wet Saw has the following features:

1. **6.7 Amp, 3550 RPM (no-load speed) motor.** Provides power and torque for fast, smooth 90° rip cuts and 0° to 45° miter cuts. The bridge adjusts to allow for 0° to 45° bevel cuts.
2. **Easy-to-read bevel and miter scales.** Bevel scales on each end of the adjustable pivoting bridge for 0° to 45° angle adjustments in 5° increments. Rip/Miter Guide allows 90° rip cuts and 0° to 45° miter cuts. Durable plastic has embossed 0° to 45° angle adjustments in single degree increments. Clear window in metal part of rip/miter guide shows ruler on fence to allow accurate measuring of workpiece.
3. **Ergonomically designed handle** with soft comfort grip for maximum control and comfortable hand support when cutting.
4. **Includes a 7-in. diameter continuous rim diamond blade** for fast, efficient cutting of ceramic, marble, slate or limestone wall or floor tile. Cuts tiles up to 1-in. (25.4mm) thick.
5. **Blade/Cutting Assembly glides on permanently lubricated 100% ball bearings** for long tool life and smooth operation.
6. **Metal upper blade guard, table base, legs, bridge supports and motor housing** for long-lasting dependable strength. Aluminum bridge and fence.
7. **Dual Spray Water Feeder System** keeps blade evenly wet for maximum blade performance.
8. **Easy-to-use knobs** for quick miter, bevel and compound miter adjustments, no tools needed.
9. **Project ruler on right fence** for quick reference; 1 to 9-inches in 1/8-in increments
10. **Laser On/Off Switch** - To turn on laser system, push switch to "On"
11. **On/Off Starter Switch with safety tab in the middle** - Remove tab when finished with saw to prevent accidental starting.
12. **Splash Guard** - Keeps water from splashing so work area stays clean.
13. **Leg Adjust Knobs** - To change height of table quickly and easily. One leg has set screw to level saw in work place.
14. **Sturdy Plastic Water Tray**
15. **Fold-up Wheels for easy transporting** - wheels pop down effortlessly by pulling the handle on their axle. You can easily move the folded-up saw from place to place as your tiling needs dictate.
16. **Double Handles on retractable pull** for easily moving the folded-up saw, with its wheels down, to the next job site.

DESCRIPTION cont.

KNOW YOUR SAW (Fig. 3) cont.

Fig. 3

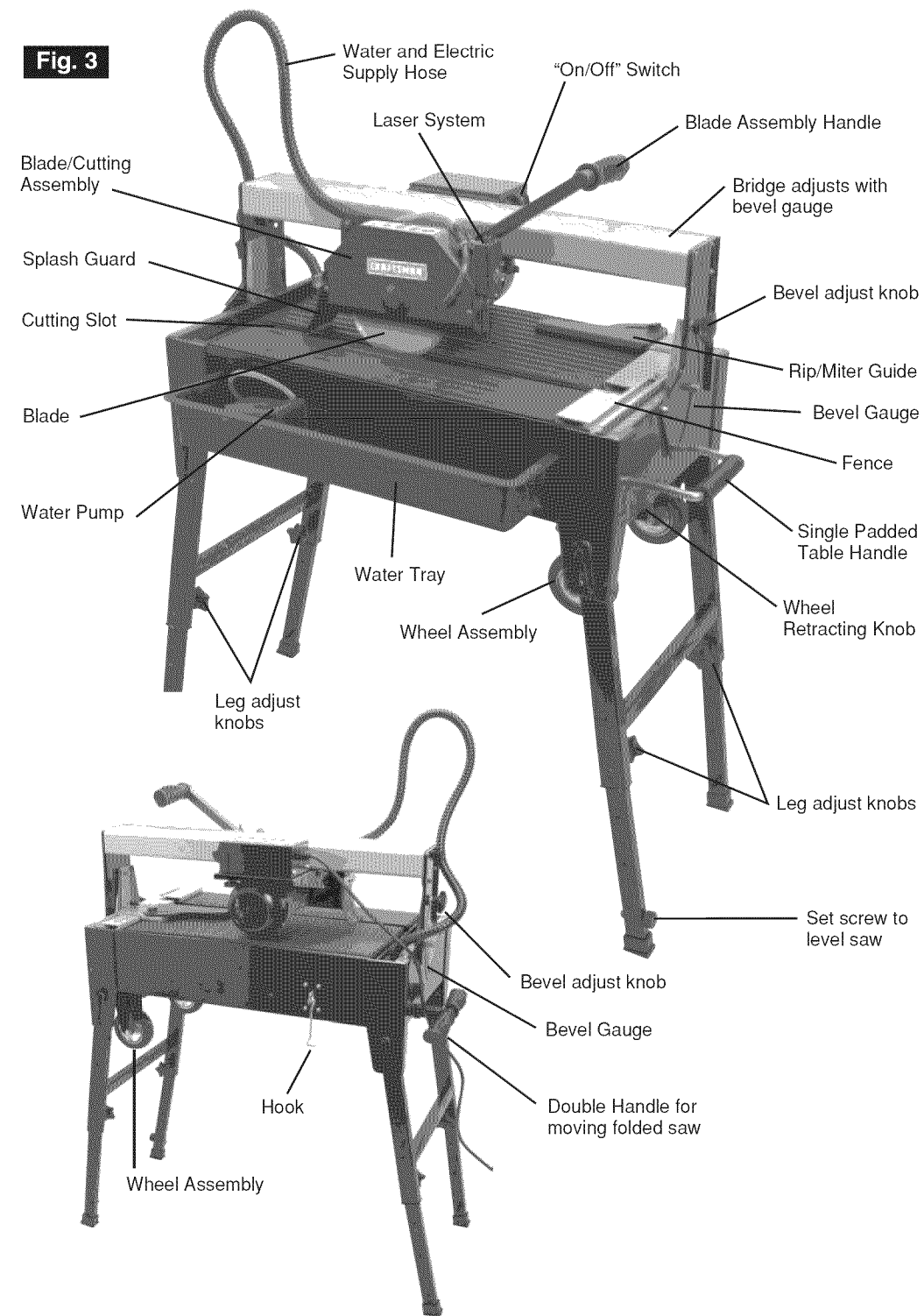

UNPACKING

1. Place carton on the floor in an area with sufficient space to inspect your saw.
2. Remove carton and packing materials from around tool.
3. Inspect the saw for loose or damaged parts. If any parts are damaged or missing, return the saw to your nearest Sears Store to have it replaced.

LOOSE PARTS LIST

The following items are included with your tile wet saw:

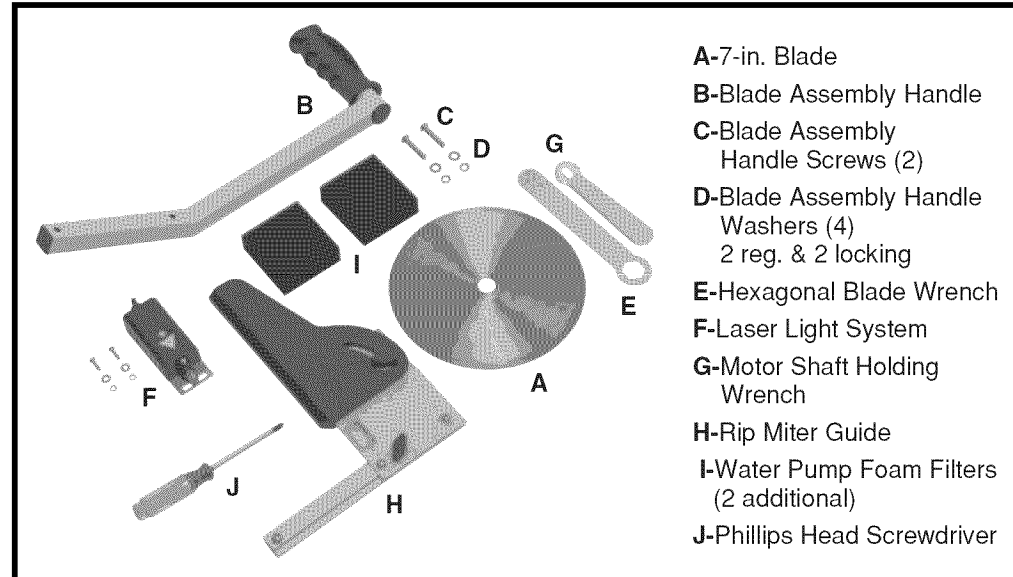

⚠ WARNING: If any parts are missing, DO NOT operate this saw until the missing parts are replaced. Failure to do so could result in serious personal injury.

⚠ CAUTION: Follow all of the assembly and installation instructions in this manual before connecting the tile saw to a power source or turning it on.

4. Lay tool on a level surface (Fig. 4).
5. To release saw table legs, pull out hook from latch and attach to peg on table base (fig. 5 and fig. 6). Grab and pull the single padded table handle on one end of tile saw and lift to unfold the first set of legs (Fig.7).
6. Slide peg on leg into notch on table base (Fig. 8). Lock legs into place by tightening butterfly knobs; repeat on other side.
7. Once legs are securely locked in place, note that telescoping legs can be adjusted to 3 different heights by loosening "screw knobs" and selecting the appropriate pinhole for desired height. To adjust height, loosen knobs on telescoping legs and realign screw knobs to desired operating height; tighten knobs to secure in place. (Fig. 9)

UNPACKING cont.

LOOSE PARTS LIST cont.

8. To stabilize and level the tile saw, adjust the leveling "set screw" located on the bottom of the left front leg (Fig. 10).
9. Attach blade/cutting assembly handle with screws provided. Put one of each washer between screw and blade and tighten screws (Fig. 11).
10. The cutting unit is locked into place during shipment. Loosen the butterfly knob located on one end of the bridge (Fig. 12) before using tool. When not in use, keep cutting unit locked in place to prevent its rolling back and forth along bridge. There is also a second locking mechanism on the blade/cutting assembly that can also be used to lock the blade cutting assembly anywhere along the bridge of the saw (Fig. 13).

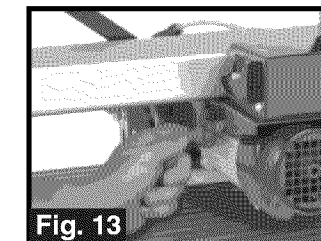
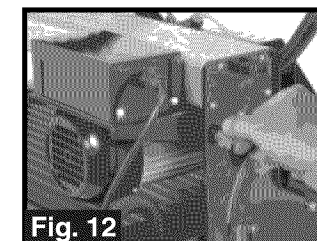
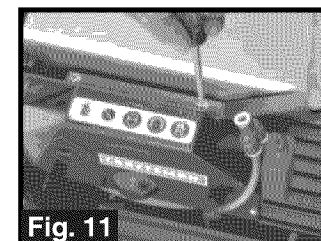
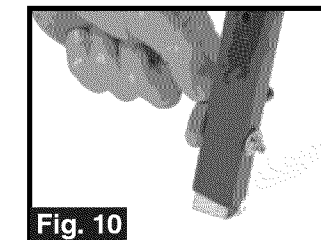
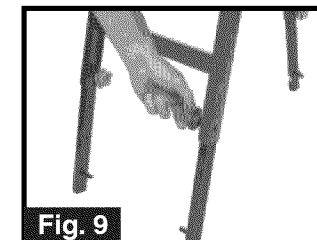
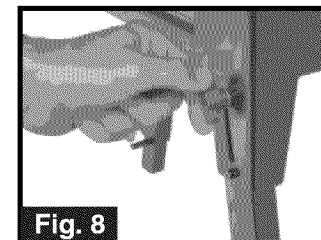
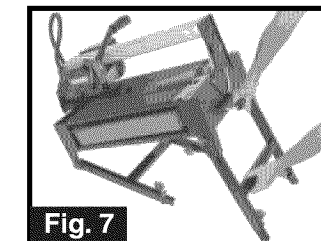
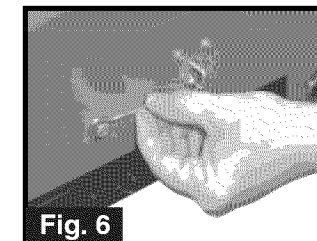
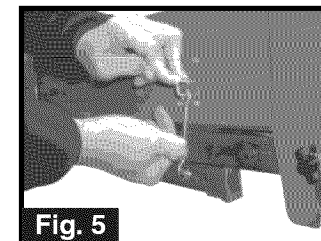
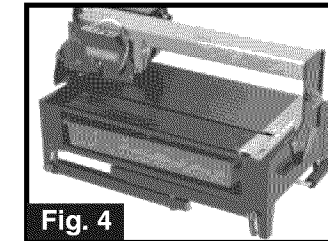

ASSEMBLY

MOUNTING LASER SYSTEM

1. Locate laser package and find the following parts as shown in (Fig. 14):
 - a) Laser light system.
 - b) Two 6/32 screws with washers.
2. Loosen bolt and remove cover. Install two AAA batteries (Fig.15), making sure both terminals are positioned correctly as the marks on the cover show, then replace cover.
3. Screw laser system onto blade guard (Fig. 16).
4. Mark a cut line on a piece of scrap tile. Turn on the laser and align the laser with the cut mark by loosening the bottom screw on the laser system (Fig. 17).
5. Cut the tile, paying attention to the position of the blade relative to the laser beam.
6. Laser beam can be adjusted to the cut line.
7. Repeat Steps 4 through 6 until laser is properly adjusted, then tighten bottom screw.

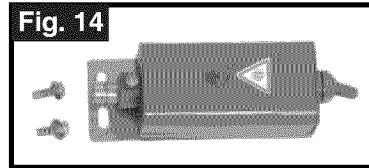

NOTE: To avoid corrosion, remove the batteries when laser system is not being used.

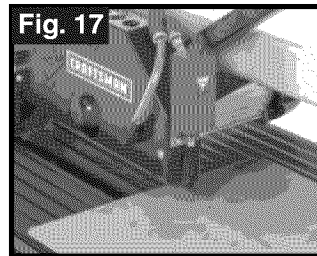
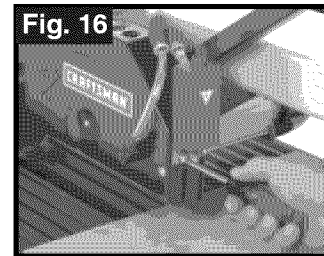
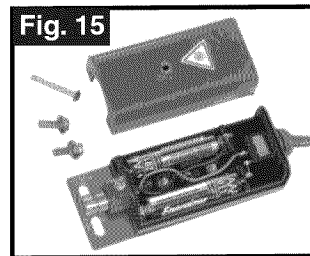

INSTALLING THE BLADE

⚠ WARNING: Disconnect the power supply before installing or making adjustments to the blade.

1. **FIRST**, to disconnect the water supply, press the blue ring and pull out the water supply tube from the inlet connection on the blade guard (Fig. 18).
2. **NEXT**, remove the blade guard by removing the two securing screws, (Fig. 19).
3. **REMOVE** blade securing nut and outer flange from shaft. Place blade onto shaft. Directional arrows on blade **MUST** line up with directional arrow on blade guard, so that material to be cut is against the direction of rotation. Re-install outer flange and nut (Fig. 20).
4. **TIGHTEN** by using the hexagonal wrench to turn the blade-securing nut counter clockwise, and the motor shaft securing wrench to hold the shaft stationary (Fig. 20a).

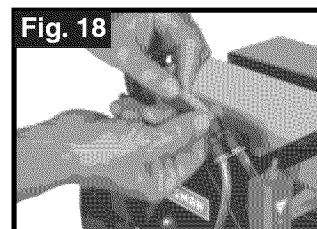

ASSEMBLY cont.

INSTALLING THE BLADE cont.

5. **REPLACE** blade guard with the two securing screws.
6. **RE-ATTACH** water supply tube to the inlet connection.

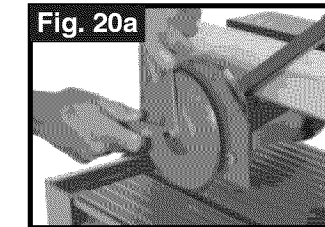
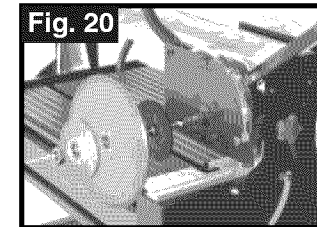
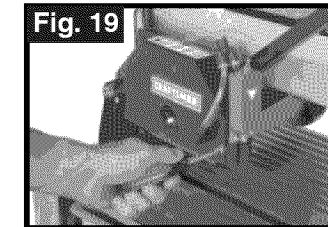

RIP/MITER GUIDE INSTALLATION

1. To install the rip/miter guide, slide aluminum arm of rip/miter guide into the groove in the fence on saw table (Fig 21).
2. The rip miter/guide can be made stationary by tightening the screw and butterfly knob located on the arm of the rip/miter guide.

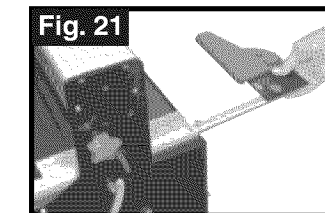

WATER PUMP SETUP AND CONNECTION

⚠ WARNING: To prevent the possibility of electrical shock, the tile saw must be unplugged when connecting water pump.

1. Check to be certain that the water supply tube is connected to the inlet connection on the blade guard (Fig. 18).
2. To connect the water pump power cord, locate the black cover box under the table. Loosen butterfly knob and remove black cover box (Fig. 21a). Plug in water pump cord, making sure fit is secure. (Fig. 22) Replace black cover box and re-tighten butterfly knob.
3. Connect tube under table to water pump discharge fitting (Fig. 23).
4. Fit water pump into housing in water tray, making certain pump discharge fitting aligns with cutout in tray housing (Fig. 24)

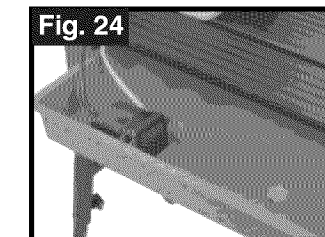
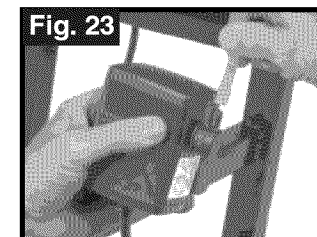
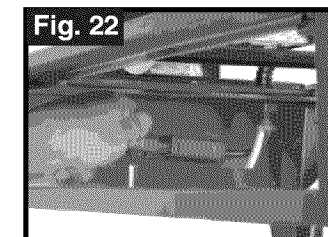
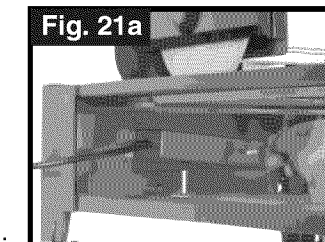

⚠ CAUTION: To prevent the possibility of electric shock, use only Sears qualified replacement parts.

OPERATION

⚠ WARNING: Turn off the saw and remove the plug from the outlet **BEFORE** adding or removing accessories and making adjustments. Failure to unplug the saw could result in accidental starting causing possible serious injury

⚠ CAUTION: This tile saw is designed to work with water. Before any cutting operation, make sure that the water level inside the water pan is between minimum and maximum level marks so that the water reaches the pump.

FILLING THE WATER TRAY

1. Fill the tray with water. Do not add chemicals or detergents to the water.
2. Be sure that the water level is always between the **MAX** and **MIN** levels shown inside the tray, so that the saw blade turns through the right amount of water and allows the saw blade to be properly cooled (Fig. 25). **DO NOT** let the saw run dry.
3. To remove the water from the tray, take out the plug and drain (Fig. 25). You can also carefully remove the tray with the water in it and pour the water out of the tray.

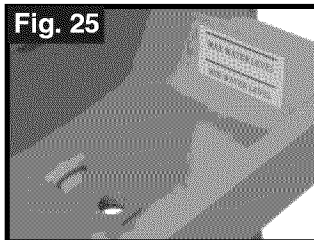

TO START THE SAW

1. Plug power cord into a **GFCI** (GROUND FAULT CIRCUIT INTERRUPTER) protected outlet.
2. To start the saw push the switch to the **“ON”** position (Fig.26)

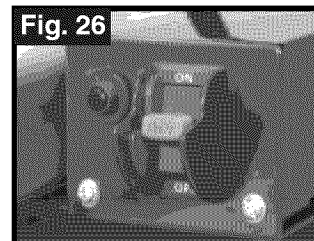

NOTE: CHECK the blade for cracks or damage **BEFORE** each use. **ALWAYS** let the blade cut at its own speed. **DO NOT** force the blade into the material being cut.

MAKING STRAIGHT, MITERED AND BEVELED CUTS

MAKING A STRAIGHT CUT

1. Loosen the knob of rip/miter guide and position the rip/miter guide so that it is in a straight line, with the zero aligned with the notch. This indicates “no angle”, or a straight cut. The rip/miter guide will be at a 90 angle to the fence. Tighten knob to keep guide in position.
2. Make a cut line on the tile. Turn on laser. Place tile on saw table. Line up the cut mark with the laser.
3. Slide the rip miter guide against the tile and lock the guide by turning the knob.
4. Keeping the tile firmly against the fence and rip/miter guide, slowly and smoothly pull blade assembly handle towards you to begin cutting. **DO NOT** force the motor to cut too quickly.

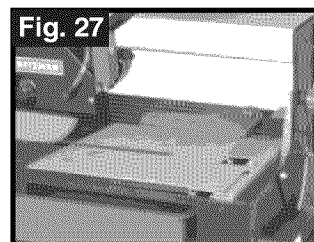

18

OPERATION cont.

MAKING A MITER CUT

1. Loosen the knob and position the rip/miter guide so that the correct angle you want, 0 to 45 , is lined up with the notch (Fig. 28). Tighten knob at that position.
2. Align tile with rip/miter guide and hold firmly against guide. Turn on laser switch. Note that laser will show cutting line. As in above straight cut, Slowly and smoothly pull blade assembly handle towards you to begin cutting.

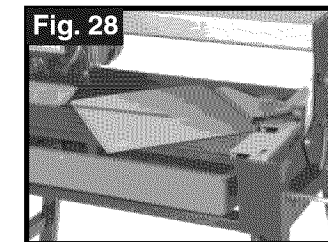

MAKING A BEVEL CUT

1. Loosen knobs on each end of saw bridge (Fig 29). Tilt the bridge to the desired bevel angle, 0 to 45 . Be sure to line up the bevel angle number markings on each end of the bridge (Fig. 30). Tighten knobs on both ends.
2. Loosen the knob of rip/miter guide and position the rip/miter guide so that it is in a straight line, with the zero aligned with the notch. This indicates “no angle”, or a straight cut. The rip/miter guide will be at a 90 angle to the fence. Tighten knob to keep guide in position.
3. Make a cut line on the tile. Turn on the laser. Place tile on saw table. Line up the cut mark with the laser (Fig. 27).
4. Slide the rip miter guide against the tile and lock the guide by turning the knob.
5. Keeping the tile firmly against the fence and rip/miter guide, slowly and smoothly pull blade assembly handle towards you to begin cutting. **DO NOT** force the motor to cut too quickly.

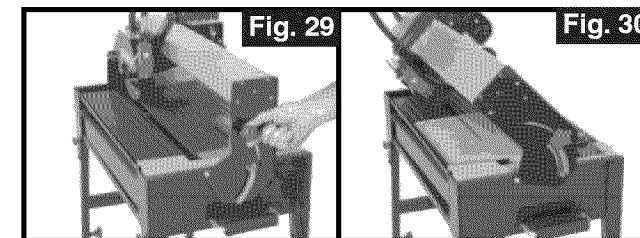

MOVING THE SAW

This step requires two people.

1. Work on the set of legs by the single padded handle and the wheel assembly first, since they need to be folded in first.
2. Loosen butterfly knobs that hold the first set of legs in place. The knobs are located on table base (Fig. 31). Pull legs out of notches on table base and fold up. The legs should be folded so that the knobs are tightened in the uppermost part of their track.
3. Now repeat on other legs. The knob for this set of legs will be slightly lower in its track, and the legs will fold up on top of the other legs. Once the legs are folded up, remove hook from peg on table and push down on the tension-mounted hook assembly to fit it into the latch on the bottom set of legs (Fig. 31a).

NOTE: The hook is spring tensioned to stay in the latch. Be sure hook is placed completely in the latch. Placing the hook in the latch only part way could cause the hook to come undone, causing possible injury.

19

OPERATION cont.

MOVING THE SAW cont.

- Your tile wet saw has been equipped with a set of wheels for easy transporting. They are to be used when the legs of the saw table are in the closed, or folded up position. To use wheels, simply pull out and down on the black handle located on the wheels' axle (Fig. 32). When not using the wheels, and to set up the saw in a new location, retract the wheels by pulling out the knob located on the table base directly above the wheels (Fig. 32a).
- Once your saw is folded up, you can easily move your saw with the double handle. To use the double handle, loosen the knob holding it in place (Fig. 33), and extend it to its full length by pulling it from the saw table base.

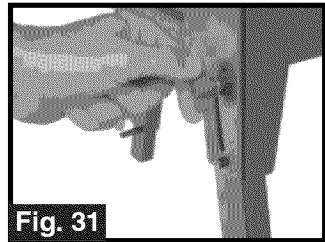

Fig. 31

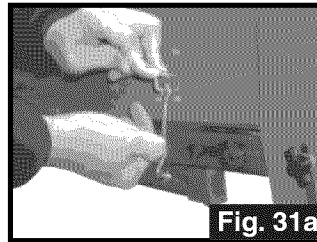

Fig. 31a

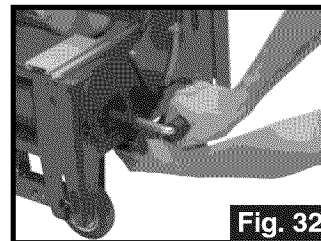

Fig. 32

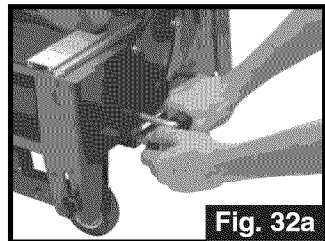

Fig. 32a

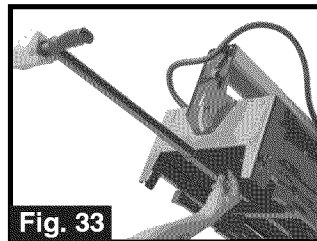

Fig. 33

MAINTENANCE

⚠ WARNING: To avoid accidents, ALWAYS disconnect the tool from the power source BEFORE making adjustments, cleaning or performing any maintenance.

NOTE: All parts represent an important part of the double insulation and should be serviced ONLY at a Sears Service Center.

NOTE: DO NOT at any time allow solvents, such as brake fluid, gasoline, petroleum-based products, penetrating oils, etc. to come in contact with plastic parts. They contain chemicals that can damage, weaken or destroy plastic.

- BEFORE each use check blade for cracks or damage.
- The tile saw **MUST BE** cleaned and dried after each use and stored in a dry location. Use clean cloths to remove dirt, carbon dust, etc.
- WIPE OFF** all exterior surfaces and keep the cutting table clean and free of all debris.
- KEEP** the ventilation slots of the tile saw clean to prevent overheating of the motor.

20

MAINTENANCE cont.

REPLACING THE BLADE (See page 14, Figs. 18, 19, 20 and 20a)

⚠ WARNING: MAKE SURE that you disconnect the power supply before replacing the blade.

NOTE: ONLY USE diamond saw blades with a diameter of 7-in. minimum and 8-in. maximum. The bore of the blade must be 5/8-in.

- FIRST**, to disconnect the water supply; press the blue ring and pull out the water supply tube from the inlet connection on the blade guard (see Fig. 18 on page 15).
- NEXT**, remove the blade guard by removing the two securing screws (see Fig. 19 on page 16).
- LOOSEN** the nut by using the hexagonal wrench to turn the blade-securing nut clockwise while using the motor shaft securing wrench to hold shaft stationary (see Fig. 20 on page 16). Remove nut and front flange, then blade.
- BE SURE** that the shaft and flanges are clean; then, paying attention to the directional arrows on the blade, mount new blade and replace outer flange and blade-securing nut. Adjust blade and tighten (see Fig. 20a on page 16).

PUMP MAINTENANCE

⚠ WARNING: MAKE SURE that you have disconnected the power supply before performing maintenance on or replacing the pump.

CLEANING THE PUMP

- To clean the pump, remove from housing in water tray. Take off the intake cover (Fig. 34).
- Take out the pump filter and impeller cover.
- Use a small brush or stream of water to remove any debris on the pump filter and impeller cover (Fig. 34).

NOTE: Always clean the pump after each use. Dried debris may stick to the filter foam and the impeller, requiring replacement of the pump filter and/or pump.

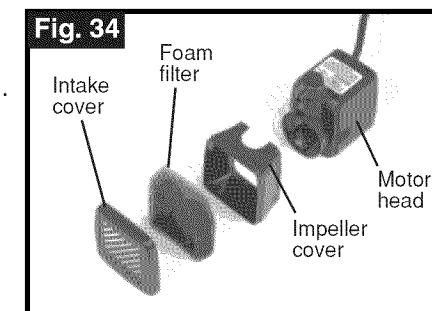

REPLACING THE PUMP FILTER

- Remove the intake cover.
- Take out pump filter and replace with the new one, (Fig. 34).
- If after replacing the filter the pump is still not working, replace the pump.

21

MAINTENANCE cont.

REPLACING THE PUMP

Only use identical replacement parts, available at your Sears Parts and Repair Center. To locate a Sears Parts and Repair Store near you, call the 800 number located on the back of this manual.

1. Remove the water tray from the saw table. Remove pump from housing in water tray. Set tray aside. Loosen knob on black cover box under saw table (Fig. 35). Remove cover box and disconnect pump plug from the socket (Fig. 36). Remove tube from water pump discharge fitting (Fig. 37).
2. Replace the old pump with the new one, carrying out the above operation in reverse order.

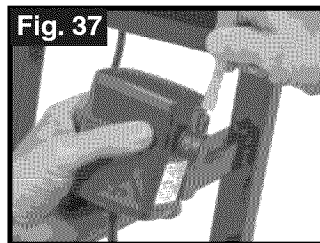
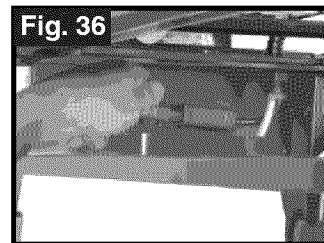
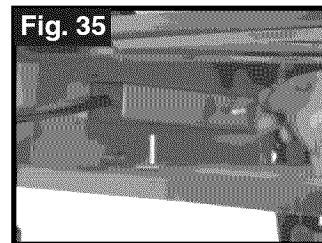

TROUBLESHOOTING

PROBLEM	CAUSE	SOLUTION
The motor is hot.	The ventilation slots in the motor are clogged with dirt The motor is defective	Clean the ventilation slots Have your machine repaired at a Sears Service Center
The machine does not work.	The power supply cord is damaged or not properly connected. No voltage in socket, or circuit breaker is off. The switch is broken.	Press the plug firmly into the power socket. Check the power supply cord. Reset the circuit breaker. Have your machine repaired at a Sears Service Center.
Water does not flow at the blade with the pump running.	Check water level Water tube from pump may be clogged The sprayer is clogged.	Add water if needed. Disconnect tube and clean out. Dismantle the sprayer and remove any residuals.
Motor gives off unpleasant odor.	Water may have seeped through inside of motor.	Unplug the power cable and consult your local Sears Service Center.
Machine is difficult to start.	Motor bearings are damaged.	Unplug the power supply cable and consult your local Sears Service Center.

REPAIR PARTS

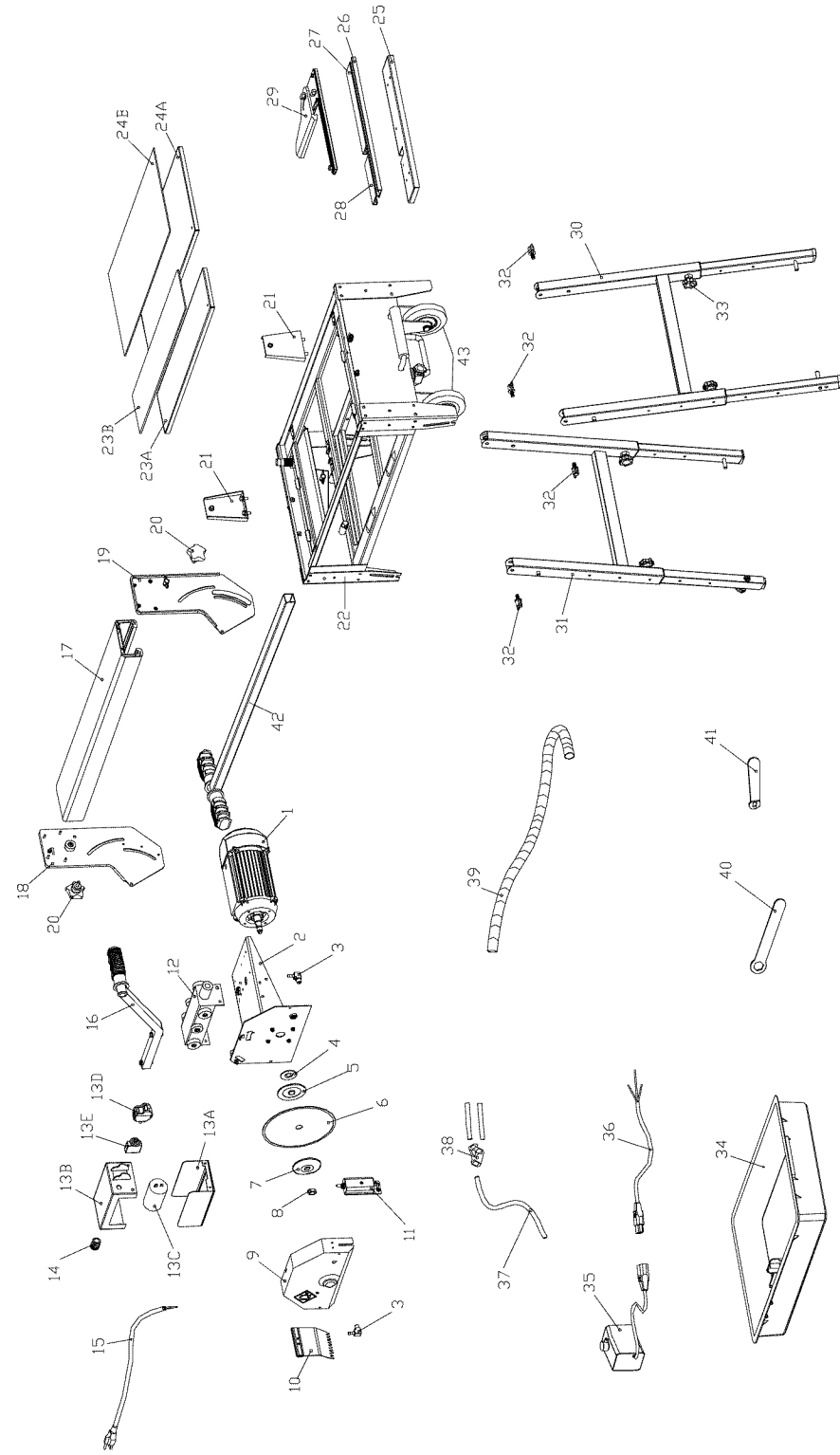

24

REPAIR PARTS cont.

7-in. TILE WET SAW – MODEL NUMBER 118.22000

The Model Number will be found on the Nameplate.

Always mention the Model Number in all correspondence regarding your tool.

Part Description	Parts No.
Motor	22000-1
Motor fixture	22000-2
right-angle connection	22000-3
Water proof for the motor	22000-4
Inside flange	22000-5
Diamond Blade	22320-9
Outside Flange	22000-7
Nut	22000-8
Safety Guard	22000-9
Water Spray Guard	22000-10
Laser System	22000-11
Motor Trolley Guide	22000-12
Connecting House	22000-13A
Connecting House Cover	22000-13B
Capacitor	22000-13C
Switch	22000-13D
Circuit Breaker	22000-13E
Cable Lock	22000-14
Power Cable	22000-15
Handle	22000-16
Slide Rail	22000-17
Rail Stand (Left)	22000-18
Rail Stand (Right)	22000-19
Knob (2)	22000-20
Rail Stand Fixture	22000-21

Part Description	Parts No.
Main Frame	22000-22
Table A	22000-23A
Rubber Mat for Table A	22000-23B
Table B	22000-24A
Rubber Mat for Table B	22000-24B
Table C	22000-25
Front Spacer	22000-26
Back Spacer	22000-27
Measuring Guide	22000-28
Angle Cutting Guide	22000-29
Stand I	22000-30
Stand II	22000-31
Wing Knob(4)	22000-32
Knob (4)	22000-33
Water Tray	22000-34
Water Pump	22000-35
Cable for the pump	22000-36
Cooling Water Pipe	22000-37
Y Connection	22000-38
Protection Plastic Tube	22000-39
Motor Shaft Wrench	22000-40
Hexagonal Blade Wrench	22000-41
Pulling rod	22000-42
Wheels (2)	22000-43

SEE BACK PAGE FOR PARTS ORDERING INSTRUCTIONS

25

Get it fixed, at your home or ours!

Your Home

For repair—in your home—of all major brand appliances, lawn and garden equipment, or heating and cooling system, **no matter who made it, no matter who sold it!**

For the replacement parts, accessories and owner's manuals that you need to do-it-yourself.

For Sears professional installation of home appliances and items like garage door openers and water heaters.

1-800-4-MY-HOME® (1-800-469-4663)

Call anytime, day or night (U.S.A. and Canada)

www.sears.com www.sears.ca

Our Home

For repair of carry-in items like vacuums, lawn equipment, and electronic, call or go on-line for the location of your nearest **Sears Parts & Repair Center.**

1-800-488-1222

Call anytime, day or night (U.S.A. only)

www.sears.com

To purchase a protection agreement (U.S.A.) or maintenance agreement (Canada) on a product serviced by Sears:

1-800-827-6655 (U.S.A.) 1-800-361-6665 (Canada)

Para pedir servicio de reparación a domicilio, y para ordenar piezas:

1-888-SU-HOGAR®

(1-888-784-6427)

Au Canada pour service en français:

1-800-LE-FOYER^{MC}

(1-800-533-6937)

www.sears.ca



© Sears Brands, LLC

® Registered Trademark / ™ Trademark / ™ Service Mark of Sears Brands, LLC

® Marca Registrada / ™ Marca de F-brica / ™ Marca de Servicio de Sears Brands, LLC

MC Marque de commerce / MD Marque déposée de Sears Brands, LLC

Free Manuals Download Website

<http://myh66.com>

<http://usermanuals.us>

<http://www.somanuals.com>

<http://www.4manuals.cc>

<http://www.manual-lib.com>

<http://www.404manual.com>

<http://www.luxmanual.com>

<http://aubethermostatmanual.com>

Golf course search by state

<http://golfingnear.com>

Email search by domain

<http://emailbydomain.com>

Auto manuals search

<http://auto.somanuals.com>

TV manuals search

<http://tv.somanuals.com>