

Operator's Manual

CRAFTSMAN[®]

19.2 VOLT CORDLESS WORKLIGHT

Model No.
315.113911

Use worklight only with recommended
Craftsman battery pack and charger
(both sold separately)

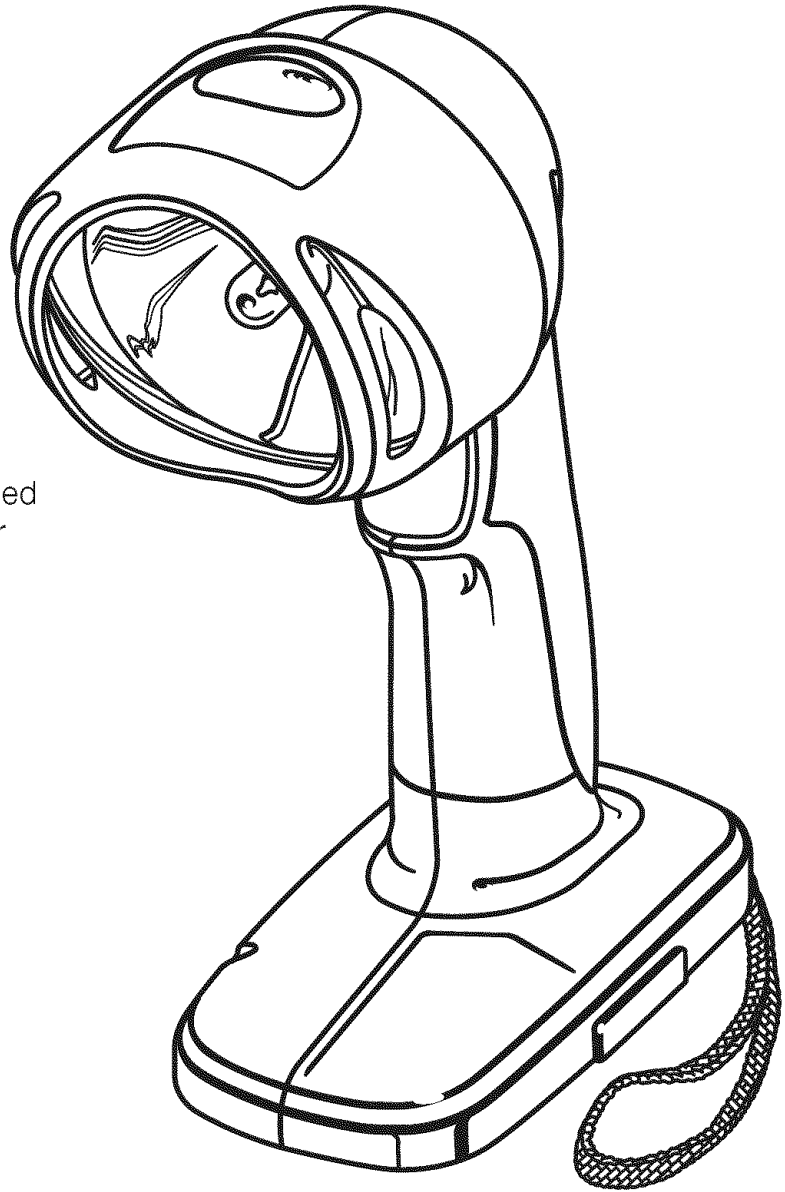

Save this manual for
future reference

⚠ WARNING: Read and follow all
Safety Rules and Operating Instructions
before first use of this product.

Customer Help Line: 1-800-932-3188

Sears, Roebuck and Co., 3333 Beverly Rd., Hoffman Estates, IL 60179 USA

Visit the Craftsman web page: www.sears.com/craftsman

983000-465
2-04



TABLE OF CONTENTS

■ Warranty.....	2
■ Introduction	2
■ General Safety Rules	3
■ Specific Safety Rules	4
■ Symbols	5-6
■ Operation	7-8
■ Maintenance	9-10
■ Parts Ordering / Service	12

WARRANTY

FULL ONE YEAR WARRANTY ON CRAFTSMAN 19.2 Volt Cordless Worklight. If this **CRAFTSMAN**® tool fails to give complete satisfaction within one year from the date of purchase, RETURN IT TO THE NEAREST SEARS STORE OR SEARS SERVICE CENTER IN THE UNITED STATES, and Sears will repair it, free of charge.

If this **CRAFTSMAN**® tool is used for commercial or rental purposes, this warranty applies for only 90 days from the date of purchase.

This warranty gives you specific legal rights, and you may also have other rights which vary from state to state.

Sears, Roebuck and Co., Dept. 817WA, Hoffman Estates, IL 60179

INTRODUCTION

This tool has many features for making your drilling operations more pleasant and enjoyable. Safety, performance and dependability have been given top priority in the design of this Cordless Worklight, making it easy to maintain and operate.

GENERAL SAFETY RULES

READ ALL INSTRUCTIONS

- **KNOW YOUR WORKLIGHT.** Read operator's manual carefully. Learn its applications and limitations as well as the specific potential hazards related to this light.
 - **USE ONLY RECOMMENDED BATTERY PACK WITH YOUR WORKLIGHT.** Any attempt to use another battery pack will cause damage to your worklight and could possibly explode, cause a fire, or personal injury.
 - **REMOVE BATTERY PACK FROM WORKLIGHT BEFORE REPLACING BULB OR PERFORMING ANY ROUTINE MAINTENANCE OR CLEANING.**
 - **DO NOT DISASSEMBLE YOUR WORKLIGHT.**
 - **DO NOT PLACE WORKLIGHT OR BATTERY PACK NEAR FIRE OR HEAT.** They may explode. Also, **DO NOT** dispose of a worn out battery pack by incinerating. Do not incinerate the battery, even if it is severely damaged or completely worn out. The battery may explode in fire.
 - **DO NOT STORE YOUR WORKLIGHT IN A DAMP OR WET LOCATION. DO NOT STORE IN LOCATIONS WHERE THE TEMPERATURE IS LESS THAN 50°F OR MORE THAN 100°F.** Do not store in outside sheds or in vehicles.
 - **DO NOT PERMIT CHILDREN TO USE WORKLIGHT UNSUPERVISED.** It is not a toy. The temperature of the bulb will become hot after being on for only a short period of time. This hot temperature can cause burn injury if touched and can create sufficient heat to melt some fabrics.
-  **WARNING:** If wrapped or in contact with fabrics, the worklight lens can produce sufficient heat to melt some fabrics. To avoid serious personal injury, never allow the worklight lens to come in contact with anything.
- **KEEP WORK AREA CLEAN.** Cluttered areas and benches invite accidents.
 - **AVOID DANGEROUS ENVIRONMENT.**
 - **KEEP LIGHT DRY, CLEAN, AND FREE FROM OIL AND GREASE.** Always use a clean cloth when cleaning. Never use brake fluids, gasoline, petroleum-based products or any strong solvent to clean your worklight.
 - **STAY ALERT.** Watch what you are doing and use common sense. Do not rush.
 - **CHECK DAMAGED PARTS.** Before further use of this worklight, a part that is damaged should be carefully checked to determine that it will operate properly and perform its intended function. Do not use worklight if it does not function properly.

SPECIFIC SAFETY RULES

 **WARNING:** Do not operate worklight or charger near flammable liquids or in gaseous or explosive atmospheres. Internal sparks may ignite fumes.

 **WARNING:** Lens and bulb become hot during use:

- During or immediately after use, don't lay worklight flat on lens surface or place lens area in contact with a plastic or fabric covered surface.
- Handle worklight with care around any flammable surface.
- Let worklight cool for several minutes after use before changing bulb.
- Do not use or permit use of worklight in bed or sleeping bags. This worklight lens can melt fabric and a burn injury could result.

SAFETY RULES FOR BATTERY TOOLS

- **USE ONLY THE CHARGER RECOMMENDED FOR USE WITH YOUR WORKLIGHT.** Do not substitute any other charger. Use of another charger could cause batteries to explode causing possible serious injury.
- Your battery tool should be charged in a location where the temperature is more than 50°F but less than 100°F.
- Under extreme usage or temperature conditions, battery leakage may occur. If liquid comes in contact with your skin, wash immediately with soap and water, then neutralize with lemon juice or vinegar. If liquid gets in your eyes, flush them with clean water for at least 10 minutes, then seek immediate medical attention.

 **WARNING:** Batteries vent hydrogen gas and can explode in the presence of a source of ignition, such as a pilot light. To reduce the risk of serious personal injury, never use any cordless product in the presence of open flame. An exploded battery can propel debris and chemicals. If exposed, flush with water immediately.

 **WARNING:** Never use a battery pack that has been damaged or received a sharp blow. A damaged battery pack is subject to explosion. Properly dispose of a damaged battery pack immediately. Failure to heed this warning can result in serious personal injury.

- **WHEN SERVICING USE ONLY IDENTICAL CRAFTSMAN REPLACEMENT PARTS.**

SAFETY INSTRUCTIONS FOR CHARGER

- Before using battery charger, read all instructions and cautionary markings in this manual, on battery charger, and product using battery charger.
CAUTION: To reduce the risk of injury, charge only nickel-cadmium type rechargeable batteries. Other types of batteries may burst causing personal injury and damage.
- Do not expose to wet or damp conditions.
- To reduce the risk of damage to charger body and cord, pull by charger plug rather than cord when disconnecting charger.
- An extension cord should not be used unless absolutely necessary. Use of improper extension cord could result in a risk of fire and electric shock. If extension cord must be used, make sure:
 - a. That pins on plug of extension cord are the same number, size and shape as those of plug on charger.
 - b. That extension cord is properly wired and in good electrical condition; and
 - c. That wire size is large enough for AC ampere rating of charger as specified below:









Cord Length (Feet)	25'	50'	100'
Cord Size (AWG)	16	16	16

Note: AWG = American Wire Gage
- **DO NOT OPERATE CHARGER WITH A DAMAGED CORD OR PLUG.** If damaged, have replaced immediately by a qualified serviceman.
- Do not operate charger if it has received a sharp blow, been dropped, or otherwise damaged in any way; take it to a qualified serviceman.
- Do not disassemble charger; take it to a qualified serviceman when service or repair is required. Incorrect reassembly may result in a risk of electric shock or fire.
- To reduce the risk of electric shock, unplug charger from outlet before attempting any maintenance or cleaning. Turning off controls will not reduce this risk.
- Do not use charger in wet or damp conditions.
- Disconnect charger from power supply when not in use.
- **SAVE THESE INSTRUCTIONS.** Review them frequently and use them to instruct others who may use this light. If you loan someone this light, loan them these instructions also.

SAVE THESE INSTRUCTIONS



SYMBOLS

Some of the following symbols may be used on this tool. Please study them and learn their meaning. Proper interpretation of these symbols will allow you to operate the tool better and safer.

SYMBOL	NAME	DESIGNATION/EXPLANATION
V	Volts	Voltage
A	Amperes	Current
Hz	Hertz	Frequency (cycles per second)
W	Watt	Power
min	Minutes	Time
~	Alternating Current	Type of current
—	Direct Current	Type or a characteristic of current
n_0	No Load Speed	Rotational speed, at no load
	Class II Construction	Double-insulated construction
.../min	Per Minute	Revolutions, strokes, surface speed, orbits etc., per minute
	Wet Conditions Alert	Do not expose to rain or use in damp locations.
	Read The Operator's Manual	To reduce the risk of injury, user must read and understand operator's manual before using this product.
	Eye Protection	Always wear safety goggles or safety glasses with side shields and a full face shield when operating this product.
	Safety Alert	Precautions that involve your safety.
	No Hands Symbol	Failure to keep your hands away from the blade will result in serious personal injury.
	No Hands Symbol	Failure to keep your hands away from the blade will result in serious personal injury.
	No Hands Symbol	Failure to keep your hands away from the blade will result in serious personal injury.
	No Hands Symbol	Failure to keep your hands away from the blade will result in serious personal injury.

SYMBOLS

The following signal words and meanings are intended to explain the levels of risk associated with this product.

SYMBOL	SIGNAL	MEANING
	DANGER:	Indicates an imminently hazardous situation, which, if not avoided, will result in death or serious injury.
	WARNING:	Indicates a potentially hazardous situation, which, if not avoided, could result in Death or serious injury.
	CAUTION:	Indicates a potentially hazardous situation, which, if not avoided, may result in minor or moderate injury.
	CAUTION:	(Without Safety Alert Symbol) Indicates a situation that may result in property damage.

SERVICE

Servicing requires extreme care and knowledge and should be performed only by a qualified service technician. For service we suggest you return the product to your nearest **AUTHORIZED SERVICE CENTER** for repair. When servicing, use only identical replacement parts.

WARNING:

Observe all normal safety precautions related to avoiding electrical shock.

WARNING:

To avoid serious personal injury, do not attempt to use this product until you read thoroughly and understand completely the operator's manual. Save this operator's manual and review frequently for continuing safe operation and instructing others who may use this product.

WARNING:



The operation of any power tool can result in foreign objects being thrown into your eyes, which can result in severe eye damage. Before beginning power tool operation, always wear safety goggles or safety glasses with side shields and a full face shield when needed. We recommend Wide Vision Safety Mask for use over eyeglasses or standard safety glasses with side shields. Always use eye protection which is marked to comply with ANSI Z87.1.

SAVE THESE INSTRUCTIONS

OPERATION

BATTERY PACK/CHARGER

The battery pack and charger are not included with your worklight. They are both sold separately. When purchasing, use the following information:

MODEL NO. BATTERY PACK CHARGER
973.113911 Item No. 9 11375 Item No. 9 11041
(1323517 or 1323903) (1425301)

BATTERY PACK

The battery pack for your worklight has been shipped in a low charge condition to prevent possible problems. Therefore, you should charge it until light on front of charger changes from red to green.

Note: Batteries will not reach full charge the first time they are charged. Allow several cycles (operating worklight followed by recharging) for batteries to become fully charged.

CHARGING BATTERY PACK

See Figure 1.

- Use only the recommended battery pack and charger with your worklight.
- **Make sure power supply is normal household voltage, 120 volts, 60 Hz, AC only.**
- Connect charger to power supply.
- Place battery pack in charger aligning raised rib on battery pack with groove in charger. See Figure 1.
- Press down on battery pack to be sure contacts on battery pack engage properly with contacts in charger.
- Normally, the red LED on charger will come on. This indicates charger is in fast charging mode.
- Red LED should remain on for approximately 1 hour then the green LED will come on. Green LED on indicates battery pack is fully charged and charger is in trickle charge mode. Note: Green LED will remain on until battery pack is removed from charger or charger is disconnected from power supply.

- If both yellow and green LED come on, this indicates a deeply discharged or defective battery pack.

Allow battery pack to remain in charger for 15 to 30 minutes. When battery pack reaches normal voltage range, red LED should come on.

If red LED does not come on after 30 minutes, this indicates a defective battery pack and should be replaced.

- After normal usage, a minimum of 1 hour of charging time is required to fully recharge battery pack.
- The battery pack will become slightly warm to the touch while charging. This is normal and does not indicate a problem.
- **Do not** place charger and battery pack in an area of extreme heat or cold. It will work best at normal room temperature.

Note: Charger and battery pack should be placed in a location where the temperature is more than 50°F but less than 100°F.

- When batteries become fully charged, unplug charger from power supply and remove the battery pack.

INFORMATION FOR RECHARGING HOT BATTERY PACK

When using your worklight continuously, the batteries in your battery pack will become hot. You should let a hot battery pack cool down for approximately 30 minutes before attempting to recharge. When the battery pack becomes discharged and is hot, this will cause the green LED to come on instead of the red LED. After 30 minutes, reinsert battery pack in charger. If green LED continues to remain on, return battery pack to your nearest Sears Repair Center for checking or replacing.

Note: This situation only occurs when continuous use of your worklight causes the batteries to become hot. It does not occur under normal circumstances. Refer to "**CHARGING BATTERY PACK**" for normal recharging of batteries. If the charger does not charge your battery pack under normal circumstances, return both the battery pack and charger to your nearest Sears Repair Center for electrical check.

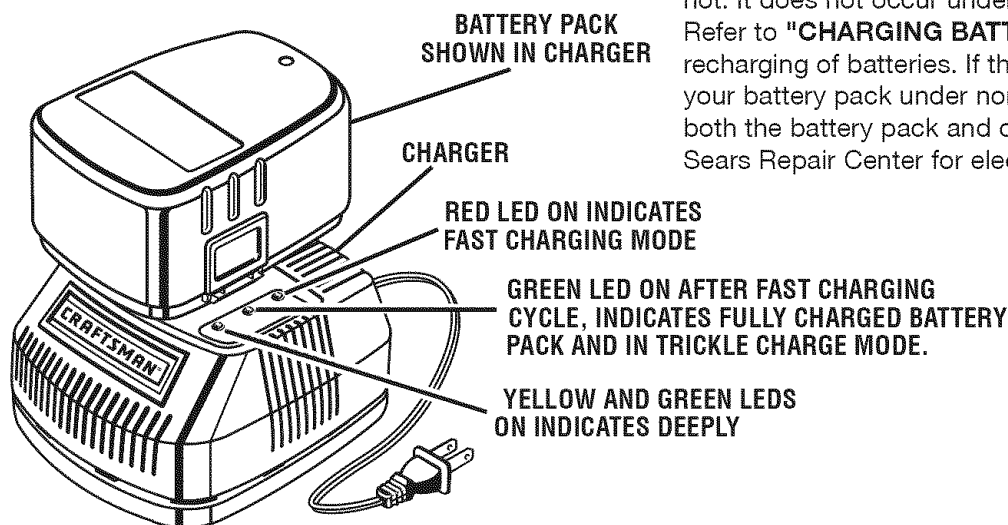

Fig. 1

OPERATION

LED FUNCTIONS OF CHARGER LED WILL BE ON TO INDICATE STATUS OF CHARGER AND BATTERY PACK:

- Red LED on = Fast charging mode.
- Green LED on = Fully charged and in trickle charge mode.
- Green LED on = When battery pack is inserted into charger, indicates hot battery pack or that battery pack is out of or below normal temperature range.
- Yellow and Green LEDs on = Deeply discharged or defective battery pack.
- No LED on = Defective charger or battery pack.

CAUTION: To prevent damage to battery pack, remove battery pack from charger immediately if no LED comes on. Return battery pack and charger to your nearest Sears Service Center for checking or replacing. Also, if you are removing battery pack from charger and no LEDs are on, return both battery pack and charger to your nearest Sears Service Center. Do not insert another battery pack into charger. A damaged charger may damage a battery pack.

TO INSTALL/REMOVE BATTERY PACK

See Figure 2.

- Use only the recommended battery pack with your worklight.
- WARNING:** Do not install battery pack to your worklight until you have read and understood all precautions and operating instructions in the manual and printed on battery pack and charger.

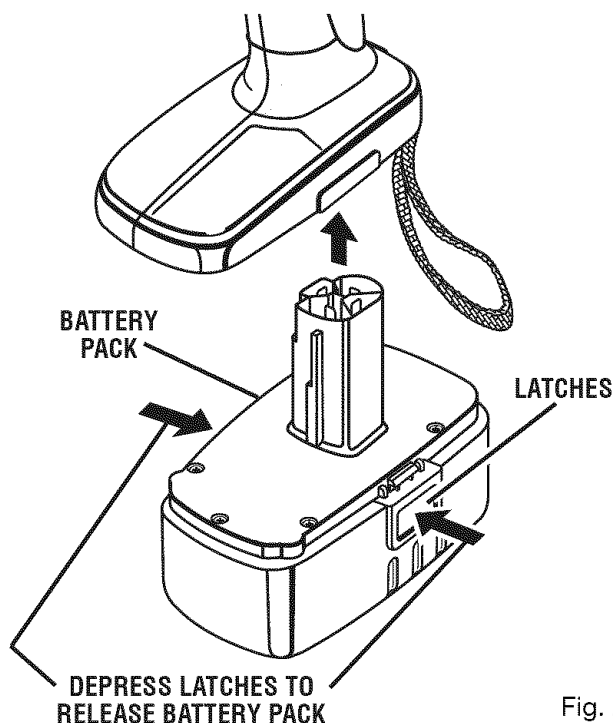

Fig. 2

- Orient battery pack so that raised rib on battery pack aligns with groove inside worklight. Battery pack is designed to fit only one way in worklight handle.
- Insert battery pack, making sure latches on each side of battery pack snap into place and battery pack is secure in worklight before use.

CAUTION: When placing battery pack in your worklight, be sure raised rib on battery pack aligns with groove inside worklight handle and latches snap into place properly. Improper assembly of battery pack can cause damage to internal components.

- To remove battery pack, locate latches on end of battery pack and depress to release battery pack from your worklight.

SWITCH

See Figure 3.

To turn your worklight on and off, depress switch trigger.

MULTI-POSITION HEAD

See Figure 3.

Your worklight has the feature of a multi-position head. Rotate head to the desired position as shown in the arrows in Figure 3.

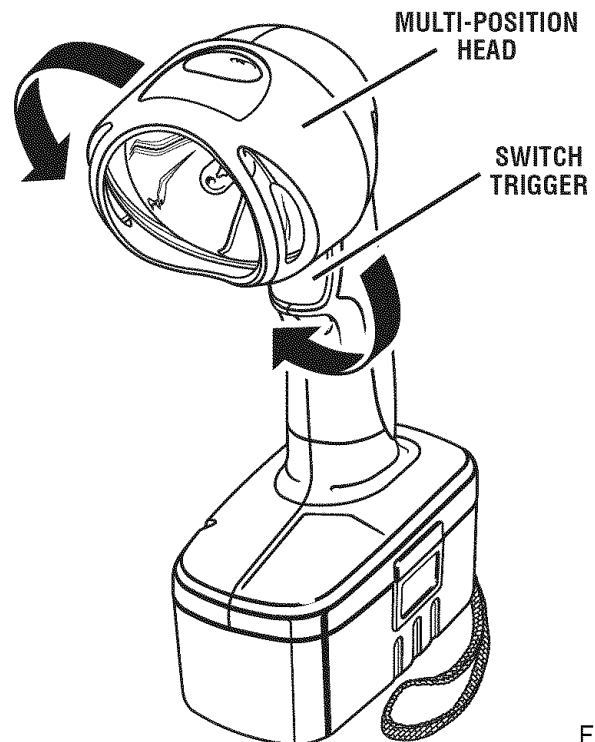

Fig. 3

MAINTENANCE

⚠ WARNING: When servicing, use only identical Craftsman replacement parts. Use of any other part may create a hazard or cause product damage.

⚠ WARNING: Do not at any time let brake fluids, gasoline, petroleum-based products, penetrating oils, etc. come in contact with plastic parts. They contain chemicals that can damage, weaken or destroy plastic.

Do not abuse power tools. Abusive practices can damage tool as well as workpiece.

⚠ WARNING: Do not attempt to modify this worklight or create accessories not recommended for use with this worklight. Any such alteration or modification is misuse and could result in a hazardous condition leading to possible serious personal injury.

BULB REPLACEMENT

See Figures 4 & 5.

When purchasing replacement bulb, request recommended part number 780115002. See Figure 5.

TO REPLACE BULB:

- Remove battery pack from worklight.

See Figure 2.

- Depress button located on top of lens cover then pull lens cover to remove.

- Remove old bulb from spring by twisting bulb in a clockwise direction.
- Insert new bulb in spring by twisting bulb in a clockwise direction.
- Replace lens cover aligning tabs inside lens cover with slots on housing then snap into place.
- Replace battery pack.

Note: For your convenience, your worklight has a bulb storage area to store an extra bulb. See Figure 5.

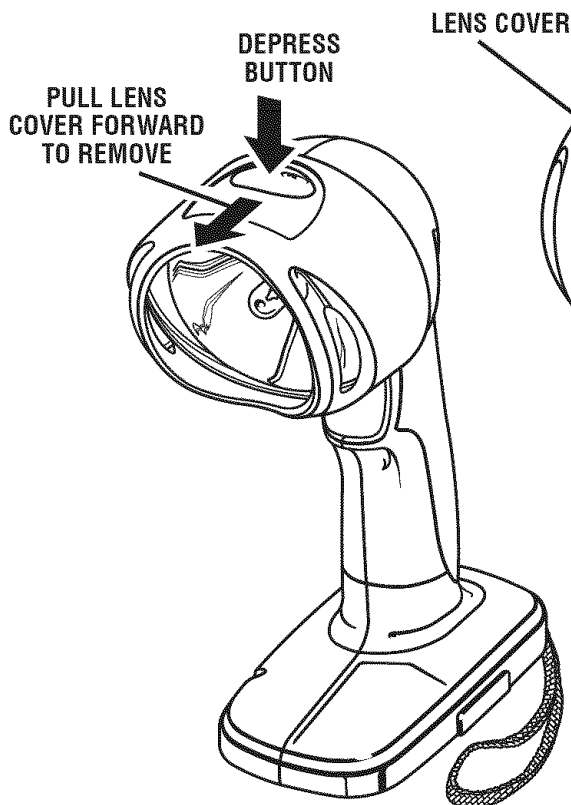

Fig. 4

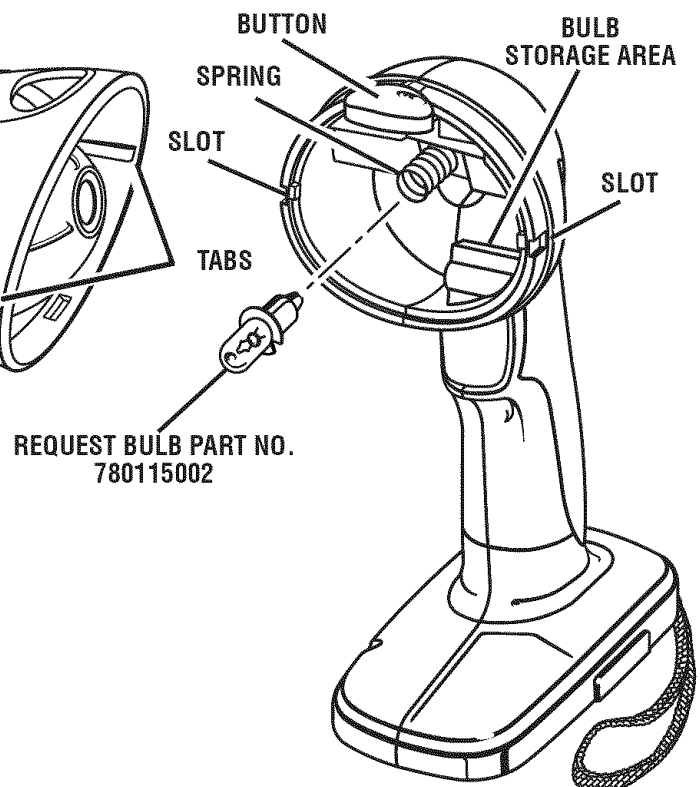

Fig. 5

MAINTENANCE

BATTERIES

Your worklight's battery pack is equipped with nickel-cadmium rechargeable batteries. Length of service from each charging will depend on the type of work you are doing.

The batteries in this worklight have been designed to provide maximum trouble free life. However, like all batteries, they will eventually wear out. **Do not** disassemble battery pack and attempt to replace the batteries. Handling of these batteries, especially when wearing rings and jewelry, could result in a serious burn.

To obtain the longest possible battery life, we suggest the following:

- Store and charge your batteries in a cool area. Temperatures above or below normal room temperature will shorten battery life.
- Never store batteries in a discharged condition. Recharge them immediately after they are discharged.
- All batteries gradually lose their charge. The higher the temperature the quicker they lose their charge. If you store your worklight for long periods of time without using it, recharge the batteries every month or two. This practice will prolong battery life.



To preserve natural resources, please recycle or dispose of batteries properly.

This product contains nickel-cadmium batteries. Local, state or federal laws may prohibit disposal of nickel-cadmium batteries in ordinary trash.

Consult your local waste authority for information regarding available recycling and/or disposal options.

BATTERY PACK REMOVAL AND PREPARATION FOR RECYCLING

⚠ WARNING: Upon removal, cover the battery pack's terminals with heavy duty adhesive tape. Do not attempt to destroy or disassemble battery pack or remove any of its components. Nickel-cadmium batteries must be recycled or disposed of properly. Also, never touch both terminals with metal objects and/or body parts as short circuit may result. Keep away from children. Failure to comply with these warnings could result in fire and/or serious injury.

⚠ WARNING: Do not attempt to disassemble the battery pack. Fire or injury may result.

Free Manuals Download Website

<http://myh66.com>

<http://usermanuals.us>

<http://www.somanuals.com>

<http://www.4manuals.cc>

<http://www.manual-lib.com>

<http://www.404manual.com>

<http://www.luxmanual.com>

<http://aubethermostatmanual.com>

Golf course search by state

<http://golfingnear.com>

Email search by domain

<http://emailbydomain.com>

Auto manuals search

<http://auto.somanuals.com>

TV manuals search

<http://tv.somanuals.com>