

Owner's Manual for the

Blue Voodoo

BV-60/BV-6212 All Tube Professional Series Guitar Amplifiers



MUSICIAN MADE IN THE U.S.A. by **CRATE**[®]

Congratulations!

Your love of performing and driving ambition to be the best have brought you to a turning point in your musical career: the incredible BV-60 or BV-6212 Professional Series guitar amplifier. An all-tube powerhouse of an amplifier designed to take you to the top and keep you there.

We know something about you: we know you were never impressed with those "toys" that some of your friends called amplifiers. We know you were holding out until **someone** offered you an American-made, affordable piece of professional equipment you could really sink your teeth into. A serious amplifier, designed for a serious musician: an amp with the sounds you've always looked for, the power you've always dreamed about, and the reliability you know you'll need. And all with a name you **know** you can trust: CRATE.









Like all Crate products, your BV-60/6212 is made with pride in America, using only the best components. Extensive testing at the hands and ears of skilled technicians and musicians insures you that this amplifier is the absolute best it can be.

In order to get the most out of your new amplifier, we strongly urge you to go over the information contained in this manual before you begin playing.

And thank you for choosing 

Contents:

Introduction	3
Features	3
The Front Panel	4
The Rear Panel	5
Some Suggested Settings	6
A Word About Tubes	7
Adjusting the Hum Balance	7
System Block Diagram	7
Technical Specifications	back cover

 CAUTION RISK OF ELECTRIC SHOCK DO NOT OPEN	 ATTENTION RISQUE D'ELECTROCUTION NE PAS OUVRIR	 VORSICHT ELEKTRISCHE SCHLAGGEFAHR NICHT OFFENEN																								
CAUTION: TO REDUCE THE RISK OF ELECTRIC SHOCK, DO NOT REMOVE COVER. NO USER-SERVICEABLE PARTS INSIDE. REFER SERVICING TO QUALIFIED SERVICE PERSONNEL.	ATTENTION: POUR REDUIRE D'ELECTROCUTION NE PAS ENLEVER LE COUVERCLE. AUCUNE PIECE INTERNE N'EST REPRABLE PAR L'UTILISATEUR. POUR TOUTE REPARATION, S'ADRESSER A UN TECHNICIEN QUALIFIE.	VORSICHT: ZUR MINIMIERUNG ELEKTRISCHER SCHLAGGEFAHR NICHT DEN DICHEL ABENHMEN. INTERNE TEILE KÖNNEN NICHT VOM BENUTZER GEWARTET WERDEN. DIE WARTUNG IS QUALIFIZIERTEM WARTUNGSPERSONAL ZU ÜBERLASSEN.																								
THIS EQUIPMENT HAS BEEN DESIGNED AND ENGINEERED TO PROVIDE SAFE AND RELIABLE OPERATION. IN ORDER TO PROLONG THE LIFE OF THE UNIT AND PREVENT ACCIDENTAL DAMAGES OR INJURY, PLEASE FOLLOW THESE PRECAUTIONARY GUIDELINES: CAUTION: TO REDUCE THE RISK OF ELECTRIC SHOCK, DO NOT OPEN CHASSIS; DO NOT DEFEAT OR REMOVE THE GROUND PIN OF THE POWER CORD; CONNECT ONLY TO A PROPERLY GROUNDED AC POWER OUTLET. WARNING: TO REDUCE THE RISK OF FIRE OR ELECTRIC SHOCK, DO NOT EXPOSE THIS EQUIPMENT TO RAIN OR MOISTURE. CAUTION: NO USER-SERVICEABLE PARTS INSIDE. REFER SERVICING TO QUALIFIED SERVICE PERSONNEL. CAUTION: THIS UNIT IS CAPABLE OF PRODUCING HIGH SOUND PRESSURE LEVELS. CONTINUED EXPOSURE TO HIGH SOUND PRESSURE LEVELS CAN CAUSE PERMANENT HEARING IMPAIRMENT OR LOSS. USER CAUTION IS ADVISED, AND EAR PROTECTION RECOMMENDED IF UNIT IS OPERATED AT HIGH VOLUME. THE CHART BELOW SHOWS THE U.S. GOVERNMENT'S OCCUPATIONAL SAFETY AND HEALTH ADMINISTRATION (OSHA) REGULATIONS WHICH WERE IN EFFECT AT THE TIME OF THIS PUBLICATION FOR PERMISSIBLE NOISE EXPOSURE, PER 29CFR1910.95, TABLE G-16:																										
<table border="1" style="margin: auto; border-collapse: collapse;"> <thead> <tr> <th>SOUND LEVEL DBA, SLOW RESPONSE</th> <th>DURATION PER DAY IN HOURS</th> <th>SOUND LEVEL DBA, SLOW RESPONSE</th> <th>DURATION PER DAY IN HOURS</th> </tr> </thead> <tbody> <tr> <td>90</td> <td>8</td> <td>102</td> <td>1 - 1 1/2</td> </tr> <tr> <td>92</td> <td>6</td> <td>105</td> <td>1</td> </tr> <tr> <td>95</td> <td>4</td> <td>110</td> <td>1/2</td> </tr> <tr> <td>97</td> <td>3</td> <td>115</td> <td>1/4 or less</td> </tr> <tr> <td>100</td> <td>2</td> <td></td> <td></td> </tr> </tbody> </table>			SOUND LEVEL DBA, SLOW RESPONSE	DURATION PER DAY IN HOURS	SOUND LEVEL DBA, SLOW RESPONSE	DURATION PER DAY IN HOURS	90	8	102	1 - 1 1/2	92	6	105	1	95	4	110	1/2	97	3	115	1/4 or less	100	2		
SOUND LEVEL DBA, SLOW RESPONSE	DURATION PER DAY IN HOURS	SOUND LEVEL DBA, SLOW RESPONSE	DURATION PER DAY IN HOURS																							
90	8	102	1 - 1 1/2																							
92	6	105	1																							
95	4	110	1/2																							
97	3	115	1/4 or less																							
100	2																									
ACCORDING TO OSHA, ANY EXPOSURE IN EXCESS TO THESE AMOUNTS LISTED ABOVE COULD RESULT IN SOME HEARING LOSS.																										
<table border="0" style="width: 100%; font-size: x-small;"> <tr> <td style="width: 50%;"> EXPLANATION OF GRAPHICAL SYMBOLS:  = "DANGEROUS VOLTAGE" "DANGER HAUTE TENSION" "GEFAHRLICHE SPANNUNG" </td> <td style="width: 50%;">  = "IT IS NECESSARY FOR THE USER TO REFER TO THE INSTRUCTION MANUAL" "REFERERZ-VOUS AU MANUAL D'UTILISATION" "UNBEDINGT IN DER BEDIENUNGSANLEITUNG NACHSCHLAGEN" </td> </tr> </table>			EXPLANATION OF GRAPHICAL SYMBOLS:  = "DANGEROUS VOLTAGE" "DANGER HAUTE TENSION" "GEFAHRLICHE SPANNUNG"	 = "IT IS NECESSARY FOR THE USER TO REFER TO THE INSTRUCTION MANUAL" "REFERERZ-VOUS AU MANUAL D'UTILISATION" "UNBEDINGT IN DER BEDIENUNGSANLEITUNG NACHSCHLAGEN"																						
EXPLANATION OF GRAPHICAL SYMBOLS:  = "DANGEROUS VOLTAGE" "DANGER HAUTE TENSION" "GEFAHRLICHE SPANNUNG"	 = "IT IS NECESSARY FOR THE USER TO REFER TO THE INSTRUCTION MANUAL" "REFERERZ-VOUS AU MANUAL D'UTILISATION" "UNBEDINGT IN DER BEDIENUNGSANLEITUNG NACHSCHLAGEN"																									

Introduction:

The BV-60/6212 are all-tube, feature-packed professional stage performers' amplifiers. Rugged construction, reliable American craftsmanship and two powerful channels of pure tube power are some of the trademarks of these new and impressive pieces of musician's equipment. Both amplifiers feature two distinctly different 12AX7 tube-driven channels: one with classic tube rhythm sounds and one offering you some of the finest lead and overdrive sounds of any stock amplifier.

Each channel features an all-tube preamp section with separate reverb level controls and three bands of equalization for total tone control. The master Presence control lets you custom tailor the sound of your guitar to suit your particular needs.

The Line Out signal is tapped directly from the speaker outputs, then attenuated and frequency-compensated to replicate the sound of a miked speaker cabinet. Two pairs of speaker output jacks provide easy and automatic impedance matching with a wide variety of cabinet configurations. The BV-60 and BV-6212 boast a solid 60 watts of musical output power.

Features:

Here's a quick overview of the BV-60/6212's features and controls. Additional information can be found on the pages indicated.

- **Patented Channel Switching Circuitry:** Achieves maximum use of each preamp tube – so unique it's patented!
- **Boost Control:** Like adding a third channel to your amp. This push-button switch gives a big boost to the midrange frequencies and the overall gain of the overdrive channel (footswitchable) (page 4).
- **Adjustable Presence Control:** Fully adjustable upper harmonics level for changing the "presence" of both channels (page 4).
- **Auto-Biasing Circuitry:** Want to change your sound? Change your tubes! Internal circuitry allows the use of either 6L6 or EL34 power tubes with no bias adjusting (page 7).
- **DC Filament Supply:** The first preamp tube has a DC filament supply for reduced hum.
- **Effects Loop:** For noiseless patching of external effects, or use as a preamp out/power amp in connection (page 5).
- **Balanced Out Jack:** Taken directly from the speaker output signal, this electronically balanced and frequency compensated output lets you patch into house sound boards, recording consoles, etc., with ultimate sonic fidelity (page 5).
- **Footswitch Jacks:** Two separate jacks – one for channel selection and boost control and one for reverb on/off control – allow use of a two or three-button footswitch for total control (page 5).
- **Speaker Jacks:** Impedance-matched speaker connectors for up to four different cabinet configurations (page 5).
- **High Cosmetic Appeal and Stage Presence:** The unique cosmetics of the BV-60/6212 serve as a tribute to your good taste in musical equipment.
- **Musician Made in the U.S.A.**

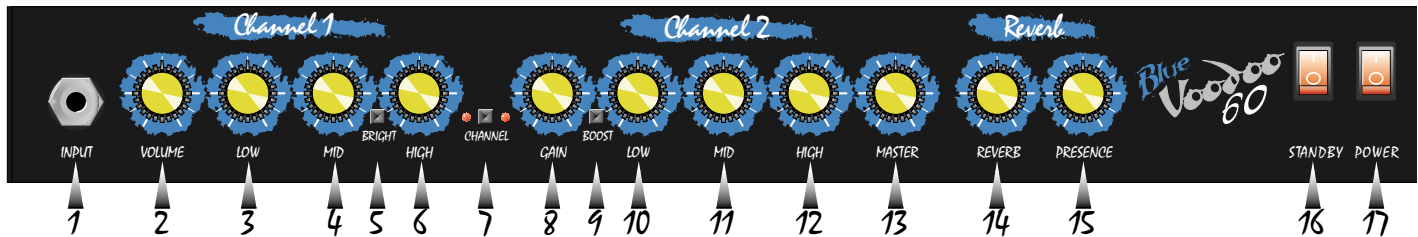

The Front Panel:

1. INPUT: Connect your guitar or wireless receiver into this standard 1/4" jack using a shielded instrument cable.

Channel 1:

2. VOLUME: Set the output volume level of channel 1 with this control.

3. LOW: Adjust the bottom end response with this control. The low control covers a range of 16dB at 100Hz.

4. MID: Adjust the midrange response with this control. The mid control covers a range of 23dB at 300Hz.

5. BRIGHT: Add a biting edge to your sound by pressing this push-button switch in. The bright switch adds 5dB at 5kHz.

6. HIGH: Adjust the high end response with this control. The high control covers a range of 25dB at 10kHz.

7. CHANNEL: Switch between channels with this push-button switch. The adjacent amber LED glows when channel 1 is selected (switch "out"), the red LED glows when channel 2 is selected (switch "in"). When a footswitch is used for channel switching, this switch is disabled.

Channel 2:

8. GAIN: Adjust the overdrive (distortion) level with this control. With the control towards "0" (to the left) the signal is relatively clean. As you bring the control towards "5" (center position) the distortion increases, along with the overall output level. Keep turning the control towards "10" and you'll increase the distortion even more.

9. BOOST: Add a third channel (sort-of) by pressing this push-button switch in. The boost switch adds 13dB at 1kHz.

10. LOW: Adjust the bottom end response with this control. The low control covers a range of 8dB at 100Hz.

11. MID: Adjust the midrange response with this control. The mid control covers a range of 7dB at 700Hz.

12. HIGH: Adjust the high end response with this control. The high control covers a range of 10dB at 10kHz.

13. MASTER: Set the output signal level of channel 2 with this control. At the "0" position (full left) very little or no signal will be heard; as you bring the control up (towards center) the output level of channel 2 increases. Use this control along with your guitar's volume and the Gain control (#8) to produce a wide variety of sounds.

14. REVERB: Adjust the amount of reverberation with this control: at the "0" position the signal is "dry" (no reverb). As you bring the control up, the amount of reverb increases.

15. PRESENCE: Increase the level of upper harmonics with this control. The presence control allows a boost of up to 5dB at 10kHz.

16. STANDBY: This switch activates the amplifier, and should always be turned **on last**. The switch lights up when the high voltage power is passing through to the tubes.

NOTE: When you first power up this amplifier, leave the Standby switch OFF for at least 20 seconds. This gives the power tubes a chance to prepare themselves for action.

17. POWER: This switch applies AC voltage to the amplifier, and should always be turned **on first**. The switch lights up when the AC power is on.

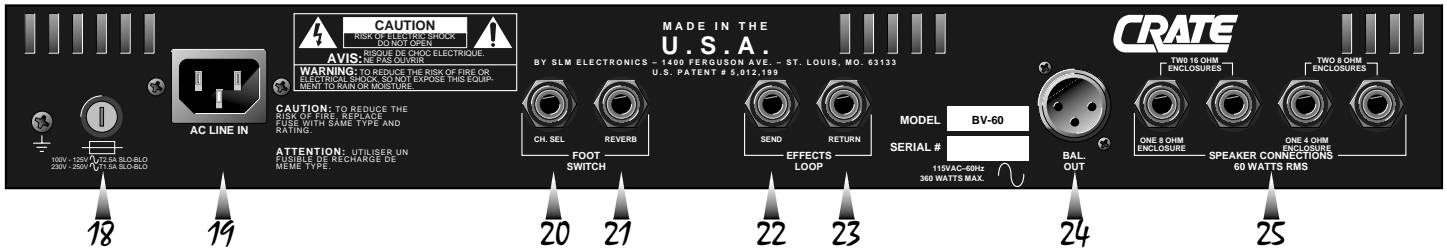

The Rear Panel:

18. FUSE: This fuse protects the amplifier against damages caused by overload conditions in the unit. If the fuse blows, replace it only with the same size and type as indicated on the rear panel. If the fuse blows continually, the line voltage may be incorrect, or the amp may need servicing.

19. AC LINE IN: Firmly plug the female end of the supplied power cord into this socket, pushing it in until it is fully seated. Plug the male end of the cord into a properly grounded AC outlet of the correct voltage. **DO NOT DEFEAT THE GROUND PIN OF THE AC PLUG!** Use only the supplied power cord. If the amplifier is to be used outside of the United States, see your authorized Crate dealer for information about alternate line cords and power converters if needed.

20. CHANNEL SELECT FOOTSWITCH JACK: Connect a stereo 1/4" plug (tip/ring/sleeve) here from either a two or three button footswitch (such as the Crate CFP-2 or CFP-3) for control of channel switching. The tip of the jack is for the channel switching; the ring is for boost control. When a footswitch is connected here, the front panel channel select and boost switches are disabled.

21. REVERB FOOTSWITCH JACK: Connect a mono 1/4" plug (tip/sleeve) here from either a one or three button footswitch for reverb on/off control.

22. EFFECTS LOOP SEND: Connection to an external effects device is made via this jack. Connect a shielded instrument patch cord from the send jack to the input jack of the effect. The send jack also doubles as a "preamp out" jack, to feed a post-eq signal to a mixing board, recording console or external amplifier.

23. EFFECTS LOOP RETURN: Connection from an external effects device is made via this jack. Connect a shielded instrument patch cord from the output jack of the effect to the return jack. The return jack also doubles as a "power amp in" jack, to feed a line-level signal directly into the BV-60/62's internal power amp. This is useful when "slaving" two amplifiers together.

24. BALANCED OUT JACK: This XLR connector supplies a balanced output signal from the power amp for patching into a mixing board, recording console or external amplifier. The signal is electronically compensated to simulate the sound of a "miked" cabinet.

25. SPEAKER JACKS: Use these unbalanced 1/4" jacks to connect the amplifier to your speaker cabinet(s) as shown below.

NOTE: You may use any configuration of impedances shown at the speaker output jacks. Impedance matching is automatic: simply connect the cabinet(s) to the jack(s) labeled with the corresponding impedance(s).

# of CABS & IMPED(S)	JACK LOCATION(S)*	JACK LABEL(S)
1 @ 4 ohms	#3	4 OHM
1 @ 8 ohms	#1	8 OHM
2 @ 8 ohms	#3,4	2-8 OHM
2 @ 16 ohms	#1,2	2-16 OHM

* Jacks numbered here for purpose of illustration only:

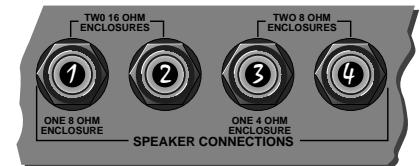

To avoid damaging the amplifier and the speaker cabinets, don't use two 4 ohm cabinets, or one 8 ohm and one 4 ohm cabinet at the same time. Do not connect a single 16 ohm cabinet to the speaker output jacks.

A SPEAKER LOAD MUST BE CONNECTED TO THE AMPLIFIER TO AVOID DAMAGING THE UNIT.

Some Suggested Settings:

SPARKLING CLEAN:

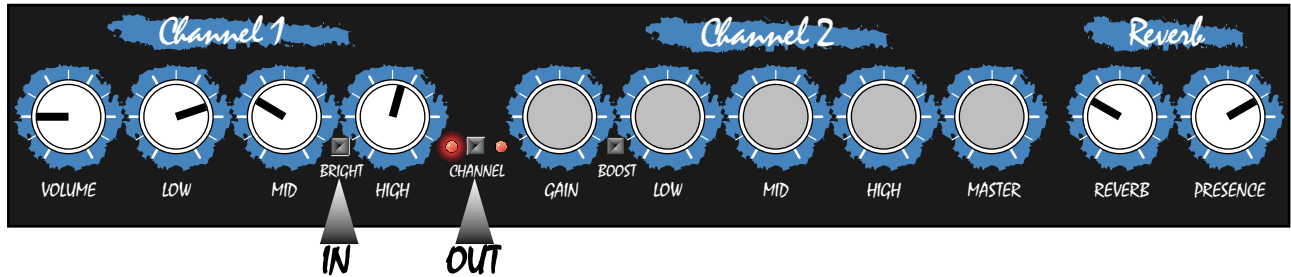

BLUESY:

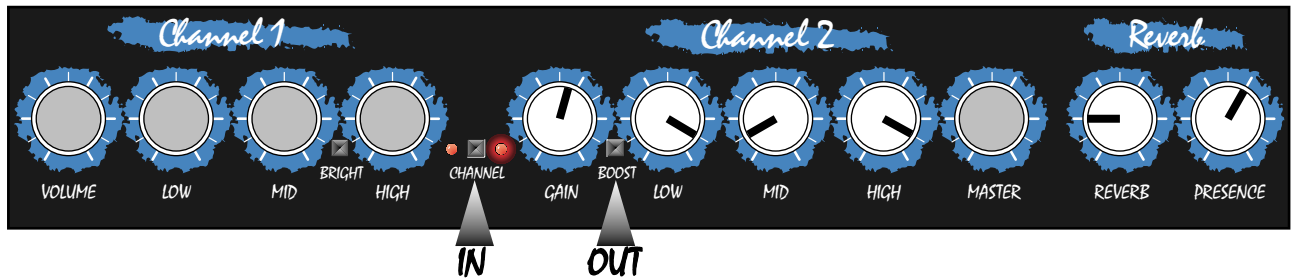

METAL:

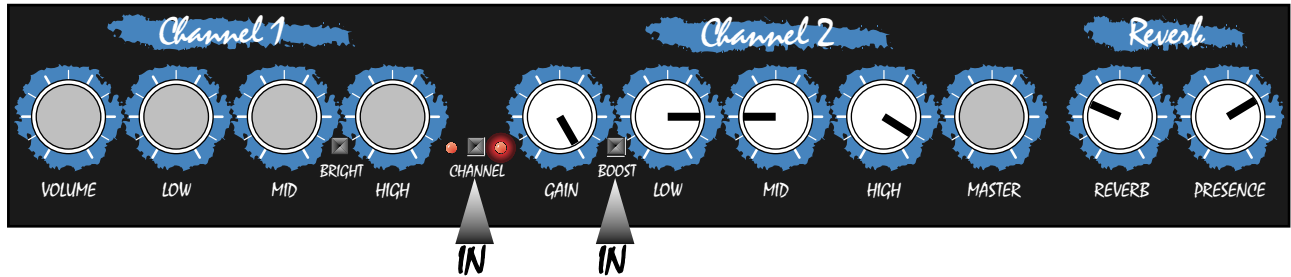

SINGING:

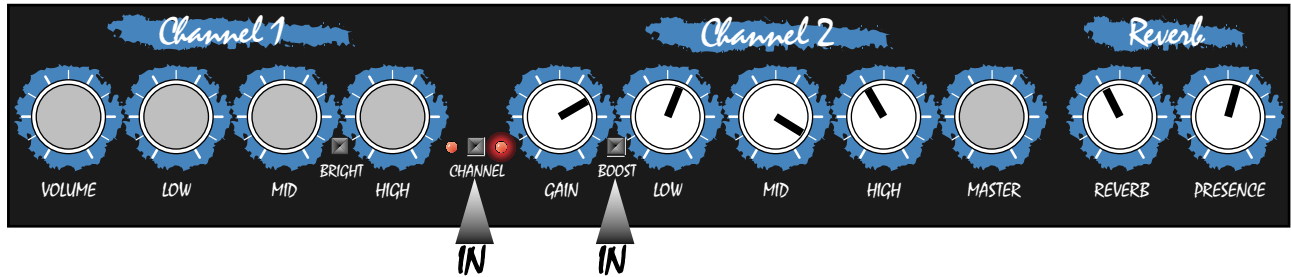

A Word About Tubes:

Vacuum tubes can only last so long. Allowing your amp to cool down before moving it will help prolong the life of the tubes. Even so, after about a year (or sooner if you're on tour or jammin' more frequently than most) you may notice the output of your amp just isn't as "alive" as it used to be. If the sound from your amplifier starts to grow weak, lacks punch, fades up and down, loses highs and lows, gets "funny" (clanking sounds, etc.), it's very likely that the power tubes are worn out and need replacing. Since power tubes work together in an amplifier, it is important that they all be replaced at the same time with a matched set of tubes.

If you're looking to change the sound of your amp, you can replace the stock 6L6 power tubes with EL34's. 6L6 tubes tend to give you more of the "American" sound, with lots of solid power, even up to their full output, with a lot of dynamic headroom. EL34 tubes tend to give you that "English/British" sound: they distort sooner and provide a more controllable and less penetrating distortion effect when overdriven. Either way, your BV-60/6212 has been engineered to facilitate power tube replacement, with automatic biasing when changing tube types. **IF YOU DON'T CONSIDER YOURSELF ADEPT WITH A SCREWDRIVER, REFER POWER TUBE REPLACEMENT TO A QUALIFIED SERVICE CENTER.** Otherwise, **unplug your amp, allow it to cool for at least thirty minutes, and proceed as follows:**

- Turn the amp so you're looking at its rear panel.
- Unscrew and remove the wooden rear cover.
- Remove the power tubes one at a time by slightly spreading the wire tube clamps with one hand and gently pulling the tube out of the socket with the other hand.
- When inserting new power tubes, carefully align the tab in the tube's plastic base with the slot in the socket and press the tube gently but firmly into place.
- Replace the rear cover piece and tighten the screws. (Avoid over tightening.)
- Power up the amplifier and let it sit for at least twenty minutes before playing.

If the amp starts to squeal, gets noisy, loses gain or starts to hum, the preamp tubes may be bad. **Since removal of the tubes may expose extremely hazardous voltage levels, always refer replacement of the preamp tubes to a qualified service center.** Insist upon using only the highest quality, low-microphonic tubes!

System Block Diagram:

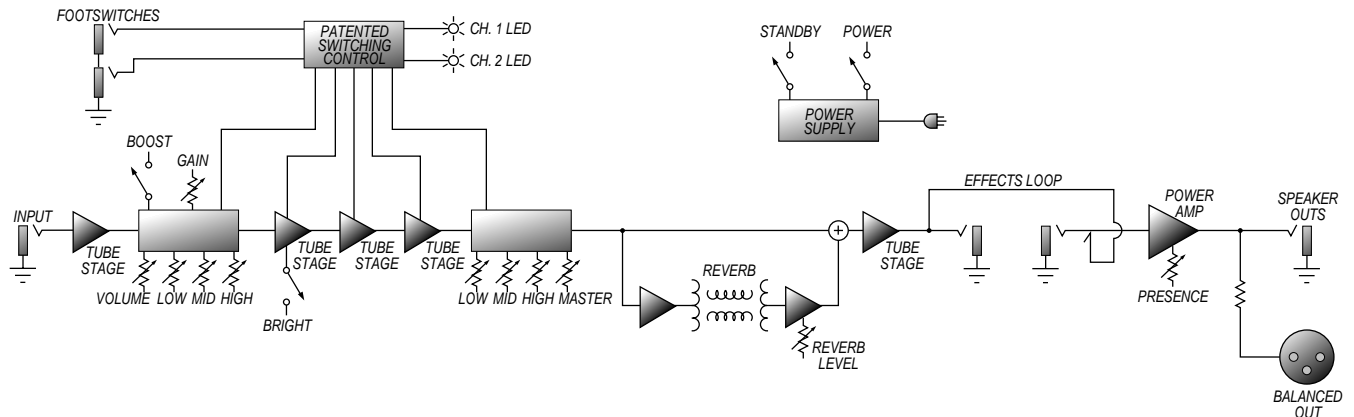

CRATE® BV-60/6212 All-Tube Professional Series Guitar Amplifiers

Technical Specifications:

Output Power Rating	60 watts RMS nominal @ 5% THD		
Input Impedance	1M ohm		
System Gain Tone Controls		Ch. 1	Ch. 2
		74dB	87dB
	Low	16dB range @ 100Hz	Low 8dB range @ 100Hz
	Mid	23dB range @ 300Hz	Mid 7dB range @ 700Hz
	High	25dB range @ 10kHz	High 10dB range @ 10kHz
	Bright	5dB boost @ 5kHz	Boost 13dB boost @ 1kHz
Presence Control	5dB boost @ 10kHz		
Effects Send/Return Level	0.7V RMS nominal		
Balanced Out Level	0.4V RMS nominal, unloaded		
Tube Complement	12AX7 (4), 12AU7 (1), 6L6 GT/5881 (2)		
Internal Speaker(s) Size and Type		BV-60	BV-6212
		12" Crate 60 watt (1)	12" Crate 30 watt (2)
	Magnet	38 oz.	30 oz.
	Voice Coil	1 3/4"	1 3/4"
	Impedance	8 ohm	16 ohm
Power Requirements	115V 60Hz, 105W; 3A Slo-Blo Fuse		
Size and Weight		BV-60	BV-6212
		19"H x 20"W x 10 1/2"D 48 lbs.	19"H x 28"W x 10 1/2"D 60 lbs.

Crate continually develops new products, as well as improves existing ones. For this reason, the specifications and information in this manual are subject to change without notice.

The BV-60 and BV-6212 are covered with high-quality, durable Tolex®. To keep them looking their best, avoid abrasive cleansers. Wipe the cabinets clean using a slightly dampened soft cloth. Do not spray cleaners directly into the amplifier. Never use brass cleaners on the hardware since they could damage their protective coatings.



©1996 SLM ELECTRONICS • A Division of St. Louis Music • 1400 Ferguson Avenue • St. Louis, Mo. 63133

P/N 47-584-02 • 09/96

Free Manuals Download Website

<http://myh66.com>

<http://usermanuals.us>

<http://www.somanuals.com>

<http://www.4manuals.cc>

<http://www.manual-lib.com>

<http://www.404manual.com>

<http://www.luxmanual.com>

<http://aubethermostatmanual.com>

Golf course search by state

<http://golfingnear.com>

Email search by domain

<http://emailbydomain.com>

Auto manuals search

<http://auto.somanuals.com>

TV manuals search

<http://tv.somanuals.com>