

CRATE

BX25 DLX / BX50 DLX BASS AMPLIFIER



User's Guide

CRATE BX25 DLX/BX50 DLX BASS AMPLIFIER

Table Of Contents:









Introduction 3

The Front Panel 4,5

Some Suggested Settings: 6

System Block Diagram 7

Technical Specifications back cover

 CAUTION RISK OF ELECTRIC SHOCK DO NOT OPEN 	 PRECAUCION RIESGO DE CORRIENTAZO NO ABRA 	 ATTENTION RISQUE D'ELECTROCUTION NE PAS OUVRIR 
WARNING: TO REDUCE THE RISK OF FIRE OR ELECTRIC SHOCK, DO NOT EXPOSE THIS APPARATUS TO RAIN OR MOISTURE. TO REDUCE THE RISK OF ELECTRIC SHOCK, DO NOT REMOVE COVER. NO USER-SERVICEABLE PARTS INSIDE. REFER SERVICING TO QUALIFIED SERVICE PERSONNEL.	PRECAUCION: PARA REDUCIR EL RIESGO DE INCENDIOS O DESCARGAS ELECTRICAS, NO PERMITA QUE ESTE APARATO QUEDA EXPUESTO A LA LLUVIA O LA HUMEDAD. PARA DISMINUIR EL RIESGO DE CORRIENTAZO NO ABRA LA CUBIERTA. NO HAY PIEZAS ADETRON QUE EL USARIO PUEDO REPARAR DEJE TODO MANTENIMIENTO A LOS TECNICOS CALIFICADOS.	ATTENTION: PROTEGEZ CET APPAREIL DE LA PLUIE ET DE L'HUMIDITE AFIN D'EVITER TOUT RISQUE D'INCENDIE OU D'ELECTROCUTION. POUR REDUIRE D'ELECTROCUTION NE PAS ENLEVER LE COUVERCLE. AUCUNE PIECE INTERNE N'EST REPRABLE PAR L'UTILISATEUR. POUR TOUTE REPARATION, S'ADRESSER A UN TECHNICIEN QUALIFIE.
IMPORTANT SAFETY INSTRUCTIONS		
<ul style="list-style-type: none"> • READ, FOLLOW, HEED, AND KEEP ALL INSTRUCTIONS AND WARNINGS. • DO NOT OPERATE NEAR ANY HEAT SOURCE AND DO NOT BLOCK ANY VENTILATION OPENINGS ON THIS APPARATUS. FOR PROPER OPERATION, THIS UNIT REQUIRES 3" (75mm) OF WELL VENTILATED SPACE AROUND HEATSINKS AND OTHER AIR FLOW PROVISIONS IN THE CABINET. • DO NOT USE THIS APPARATUS NEAR SPLASHING, FALLING, SPRAYING, OR STANDING LIQUIDS. • CLEAN ONLY WITH LINT-FREE DAMP CLOTH AND DO NOT USE CLEANING AGENTS. • ONLY CONNECT POWER CORD TO A POLARIZED, SAFETY GROUNDED OUTLET WIRED TO CURRENT ELECTRICAL CODES AND COMPATIBLE WITH VOLTAGE, POWER, AND FREQUENCY REQUIREMENTS STATED ON THE REAR PANEL OF THE APPARATUS. • PROTECT THE POWER CORD FROM DAMAGE DUE TO BEING WALKED ON, PINCHED, OR STRAINED. • UNPLUG THE APPARATUS DURING LIGHTNING STORMS OR WHEN UNUSED FOR LONG PERIODS OF TIME. • ONLY USE ATTACHMENTS, ACCESSORIES, STANDS, OR BRACKETS SPECIFIED BY THE MANUFACTURER FOR SAFE OPERATION AND TO AVOID INJURY. • THIS APPARATUS DOES NOT OPERATE NORMALLY AND REQUIRES SERVICE WITH ANY PHYSICAL DAMAGE FROM IMPACT OR ANY EXPOSURE TO MOISTURE. • SERVICE MUST BE PERFORMED BY QUALIFIED PERSONNEL. • OUR AMPLIFIERS ARE CAPABLE OF PRODUCING HIGH SOUND PRESSURE LEVELS. CONTINUED EXPOSURE TO HIGH SOUND PRESSURE LEVELS CAN CAUSE PERMANENT HEARING IMPAIRMENT OR LOSS. USER CAUTION IS ADVISED AND EAR PROTECTION IS RECOMMENDED IF UNIT IS OPERATED AT HIGH VOLUME. 		
EXPLANATION OF GRAPHICAL SYMBOLS: EXPLICACION DE SIMBOLOS GRAFICOS: EXPLICATION DES SYMBOLES GRAPHIQUES:	 = "DANGEROUS VOLTAGE" "VOLTAJE PELIGROSO" "DANGER HAUTE TENSION"	 = "IT IS NECESSARY FOR THE USER TO REFER TO THE INSTRUCTION MANUAL" "ES NECESARIO QUE EL USUARIO SE REFIERA AL MANUAL DE INSTRUCCIONES." "REFERREZ-VOUS AU MANUAL D'UTILISATION"

CRATE BX25 DLX/BX50 DLX BASS AMPLIFIER

Congratulations!

You are now the proud owner of the compact but powerful Crate BX25DLX/BX50DLX Bass Amplifier. The BX25DLX/BX50DLX features two different channels: a distortion channel, featuring Crate's exclusive Shape control for quick and easy access to the tone you need, and a clean channel with a four-band rotary EQ. Another unique and valuable feature of this amplifier is the Octave control. This feature electronically creates a second signal that is one octave lower than the original signal. An active electronic tuner, conveniently located on top of the amplifier, allows you to get in tune and stay in tune "on the fly." Front panel jacks are provided for connecting a CD player and a pair of headphones, thereby optimizing your practice time.

Like all Crate products, your BX25DLX/BX50DLX is designed by musicians and built using only the best components. Extensive testing at the hands (and ears) of skilled technicians and musicians insures you that this amplifier is the absolute best it can be.

In order to get the most out of your new bass amp, we urge you to check out the information in this manual before you begin playing.

And **thank you** for choosing **CRATE**[®]

Declaration Of Conformity

#28, Effective 01-01-2001

Manufacturer's Name:	SLM Electronics
Production Facility:	11880 Borman Drive, St. Louis, MO 63146, USA
Production Facility:	700 Hwy 202 W, Yellville, AR 72687, USA
Shipping Facility:	1400 Ferguson Ave., St. Louis, MO 63133, USA
Office Facility:	1400 Ferguson Ave., St. Louis, MO 63133, USA
Product Type:	Audio Amplifier
Complies with Standards:	
LVD:	92/31/EEC, 93/68/EEC, & 73/23/EWG
Safety:	EN60065
EMC:	EN55013, EN55020, EN55022, EN61000-3-2, & EN61000-3-3

Supplementary information provided by your local Sales & Services Office or:
SLM Electronics - R & D Engineering
1901 Congressional Drive, St Louis, MO 63146, USA
Tel.: 314-569-0141, Fax: 314-569-0175

CRATE BX25 DLX/BX50 DLX BASS AMPLIFIER

The Front Panel:



- 1. INPUT:** Use this 1/4" jack to connect your bass to the amplifier by means of a shielded instrument cable.
 - 2. GAIN:** Use this control to adjust the amount of distortion for the Distortion/A channel. As you rotate the control clockwise the amount of distortion increases.
 - 3. SHAPE:** Use this control to adjust the tone of the Distortion/A channel, from a studio "V"-shaped tone to a more "live," more present sound.
 - 4. LEVEL:** Use this control to adjust the output level of the Distortion/A channel.
 - 5. CHANNEL SWITCH:** Use this switch to select either channel. With the switch in the out position, the Clean/B channel is selected. When the switch is depressed, the Distortion/A channel is selected. The adjacent LED illuminates when the Distortion/A channel is selected. **NOTE:** When using the footswitch (#18): when this switch is depressed, the footswitch switches between the Distortion/A channel and the Clean/B channel; when this button is in the out position, the Clean/B channel is always active, and the footswitch turns the Distortion/A channel on and off, allowing you a blend of both channels.
 - 6. LEVEL:** Use this control to adjust the output level of the Clean/B channel, and as part of the Octave level control (see #11).
- NOTE: The BX25DLX/BX50DLX employs an internal noise gate to keep residual noise to a minimum. Regardless of which channel is selected, the Clean/B channel's Level control (#6) must be turned up above "0" in order for the noise gate to trigger.*
- 7. LOW:** Use this control to adjust the low frequency level of the Clean/B channel.
 - 8. LOW MID:** Use this control to adjust the lower-midrange frequency output of the Clean/B channel.
 - 9. HIGH MID:** Use this control to adjust the upper-midrange frequency output of the Clean/B channel.
 - 10. HIGH:** Use this control to adjust the high frequency output of the Clean/B channel.
 - 11. OCTAVE:** The BX25DLX/BX50DLX features internal circuitry which creates a second signal which is one octave lower than the input signal. Use this control in conjunction with the Clean/B channel's Level control (#6) to adjust the level of the octave signal.
 - 12. MASTER:** Use this control to adjust the overall output level of the amplifier.

CRATE BX25 DLX/BX50 DLX BASS AMPLIFIER



13. CD INPUT: Use these RCA jacks to connect the line level (or headphones) output of a CD player, tape deck or rhythm machine to the amplifier. The signal level from these jacks is adjusted by the Master control (#12). If the signal from the source connected to these jacks is too strong, use the output level control on the source to adjust the signal to obtain the proper level for a good mix.

14. HEADPHONES: Use this jack to listen to the amplifier through a pair of stereo headphones. The internal speaker is disconnected when the headphones jack is used.

CAUTION: To avoid possible damage to your hearing, do not use headphones for extended periods of time at extremely loud listening levels.

15. POWER: Use this switch to turn the amplifier on and off. The adjacent LED illuminates when the amplifier is turned on.

16. ELECTRONIC TUNER (top panel): This active electronic tuner is on whenever the amplifier is turned on, allowing you constant, “real-time” tuning. The tuner is fully chromatic – use the flat and sharp indicators until the LED between them illuminates, indicating proper tuning.

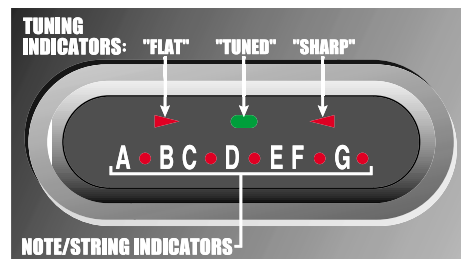

17. AC LINE CORD (rear panel, not shown): The grounded power cord should only be plugged into a grounded power outlet that meets all applicable electrical codes and is compatible with the voltage, power, and frequency requirements stated on the rear panel. **Do not attempt to defeat the safety ground connection.**

18. FOOTSWITCH (rear panel, not shown): Connect a two-button footswitch (such as the Crate CFP-2) here for remote control of the channel selection/“blend” (see #5”) and octave on/off. (When the Channel Switch [#5] is depressed, the footswitch switches between the Clean/B channel and the Distortion/A channel; when the switch is in the out position, the Clean/B channel is always active, and the footswitch turns the Distortion/A channel on and off, allowing you a blend of both channels.)

19. EXTERNAL SPEAKER (rear panel, not shown): Use this jack to connect the amplifier to an external speaker cabinet (BX25DLX = 4Ω minimum, BX50DLX = 8Ω minimum). The internal speaker is disconnected when the external speaker jack is used.

CRATE BX25 DLX/BX50 DLX BASS AMPLIFIER

Suggested Starting Settings:

Rock:



Jazz:



Country:



Funk:



Solo Fuzz:



Super Fat Fuzz:

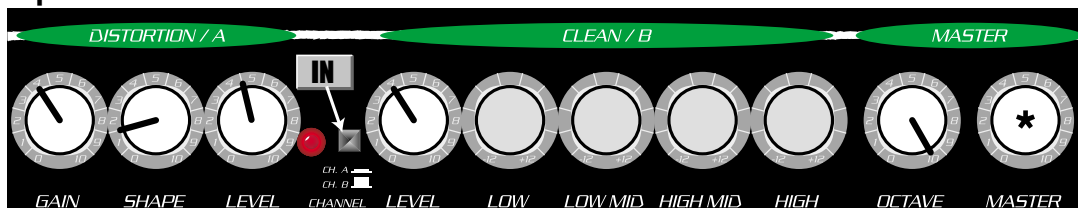

CRATE BX25 DLX/BX50 DLX BASS AMPLIFIER

System Block Diagram:

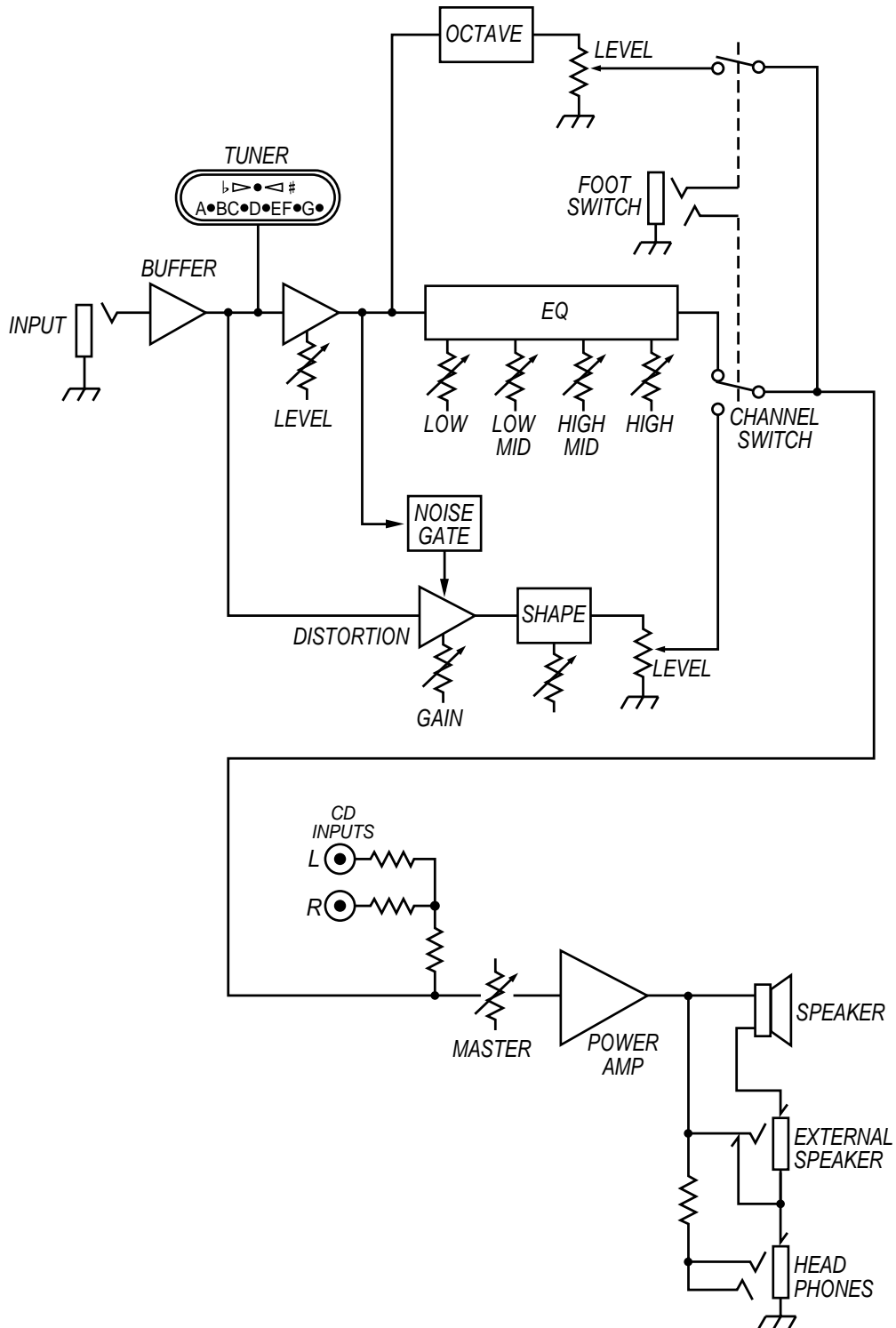

CRATE BX25 DLX/BX50 DLX BASS AMPLIFIER

BX25DLX/BX50DLX TECHNICAL SPECIFICATIONS:

		BX25DLX	BX50DLX
Output Power Rating		27W RMS 1%THD 4Ω, 120 VAC	50W RMS 1.5%THD 4Ω 120 VAC
Gain	Channel A	115dB	115dB
	Channel B	76dB	76dB
	CD Inputs	36dB	36dB
Tone Range	Low	20dB @ 50Hz	20dB @ 50Hz
	Low Mid	24dB @ 150Hz	24dB @ 150Hz
	High Mid	20dB @ 1kHz	20dB @ 1kHz
	High	34dB @ 10kHz	34dB @ 10kHz
Signal to Noise Ratio		75dB	75dB
Input Impedance		220k ohms	220k ohm
Maximum Signal Accepted		7 volts, peak-to-peak	7 volts, peak-to-peak
Power Requirements		110VAC, 60Hz, 45VA	110VAC, 60Hz, 85VA
		100/110VAC, 50/60Hz, 45VA	100/110VAC, 50/60Hz, 85VA
		230VAC, 50/60Hz, 45VA	230VAC, 50/60Hz, 85VA
Internal Speaker	Size	10"	12"
	Type	Crate Custom	Crate Custom
	Magnet	30 oz	30 oz
	Voice Coil	1.0"	1.5"
	RMS Rating	30 watts	50 watts
	Impedance	4 ohms	8 ohms
Size		17" H x 17" W x 12" D	20.62" H x 17" W x 13.5" D
Weight		39 lbs	47 lbs

The BX25DLX/BX50DLX is covered with a durable black Tolex material: wipe it clean with a lint-free cloth. Never spray cleaning agents onto the cabinet. Avoid abrasive cleansers which would damage the finish.

Crate continually develops new products, as well as improves existing ones. For this reason, the specifications and information in this Crate manual are subject to change without notice.

CRATE[®]

www.crateamps.com



©2002 SLM ELECTRONICS, A DIVISION OF ST. LOUIS MUSIC, 1400 FERGUSON, ST. LOUIS, MO. 63133

P/N 47-093-01 • 120202

Free Manuals Download Website

<http://myh66.com>

<http://usermanuals.us>

<http://www.somanuals.com>

<http://www.4manuals.cc>

<http://www.manual-lib.com>

<http://www.404manual.com>

<http://www.luxmanual.com>

<http://aubethermostatmanual.com>

Golf course search by state

<http://golfingnear.com>

Email search by domain

<http://emailbydomain.com>

Auto manuals search

<http://auto.somanuals.com>

TV manuals search

<http://tv.somanuals.com>