

CRATE

GLX65

GLX120

GLX212

**Three-channel Guitar Amplifiers
with DSP & Channel Tracking**



User's Guide

Congratulations!

You are now the proud owner of one of the Crate GLX top-of-the-line three-channel guitar amplifiers. These rugged amplifiers combine outstanding features with serious clean and distorted sounds. An easy to operate DSP section lets you dial in a variety of digital effects including reverbs, delays, octave and wah-wahs – with a separate level control. Crate's unique **Channel Tracking** feature means that as you switch between channels and gains, the DSP automatically “tracks” the changes - your DSP settings for each channel are stored and automatically recalled! The supplied three-button footswitch allows you to select between the three channels and turn the DSP on and off by “remote control.” The top-mounted electronic tuner lets you get tuned and stay in tune any time the amplifier is on.

Like all Crate products, your GLX amplifier is designed by musicians, and built using only the best components. Extensive testing confirms that this amplifier is the absolute best it can be.

In order to get the most out of your new amplifier, we strongly urge you to read this user's guide before you begin playing.



And **thank you** for choosing

TABLE OF CONTENTS:	
The Digital Signal Processor	3
Channel Tracking	3
The Front Panel	4
The Electronic Tuner	5
The Rear Panel	5
Suggested Settings	6
System Block Diagram	7
Technical Specificationsback cover

 CAUTION RISK OF ELECTRIC SHOCK DO NOT OPEN	 PRECAUCION RIESGO DE CORRIENTAZO NO ABRA	 ATTENTION RISQUE D'ELECTROCUTION NE PAS OUVRIR
<small>WARNING: TO REDUCE THE RISK OF FIRE OR ELECTRIC SHOCK, DO NOT EXPOSE THIS APPARATUS TO RAIN OR MOISTURE. TO REDUCE THE RISK OF ELECTRIC SHOCK, DO NOT REMOVE COVER. NO USER-SERVICEABLE PARTS INSIDE. REFER SERVICING TO QUALIFIED SERVICE PERSONNEL.</small>	<small>PRECAUCION: PARA REDUCIR EL RIESGO DE INCENDIOS O DESCARGAS ELECTRICAS, NO PERMITA QUE ESTE APARATO QUEDE EXPUESTO A LA LLUVIA O LA HUMEDAD. PARA DISMINUIR EL RIESGO DE CORRIENTAZO, NO ABRA LA CUBIERTA. NO HAY PIEZAS ADETRON QUE EL USARIO PUEDE REPARAR. DEJE TODO MANTENIMIENTO A LOS TECNICOS CALIFICADOS.</small>	<small>ATTENTION: PROTEGEZ CET APPAREIL DE LA PLUIE ET DE L'HUMIDITE AFIN D'EVITER TOUT RISQUE D'INCENDIE OU D'ELECTROCUTION. POUR REDUIRE D'ELECTROCUTION NE PAS ENLEVER LE COUVERCLE. AUCUNE PIECE INTERNE N'EST REPRABLE PAR L'UTILISATEUR. POUR TOUTE REPARATION, S'ADRESSER A UN TECHNICIEN QUALIFIE.</small>

IMPORTANT SAFETY INSTRUCTIONS

- READ, FOLLOW, HEED, AND KEEP ALL INSTRUCTIONS AND WARNINGS.
- DO NOT OPERATE NEAR ANY HEAT SOURCE AND DO NOT BLOCK ANY VENTILATION OPENINGS ON THIS APPARATUS. FOR PROPER OPERATION, THIS UNIT REQUIRES 3" (75mm) OF WELL VENTILATED SPACE AROUND HEATSINKS AND OTHER AIR FLOW PROVISIONS IN THE CABINET.
- DO NOT USE THIS APPARATUS NEAR SPLASHING, FALLING, SPRAYING, OR STANDING LIQUIDS.
- CLEAN ONLY WITH LINT-FREE DAMP CLOTH AND DO NOT USE CLEANING AGENTS.
- ONLY CONNECT POWER CORD TO A POLARIZED, SAFETY GROUNDED OUTLET WIRED TO CURRENT ELECTRICAL CODES AND COMPATIBLE WITH VOLTAGE, POWER, AND FREQUENCY REQUIREMENTS STATED ON THE REAR PANEL OF THE APPARATUS.
- PROTECT THE POWER CORD FROM DAMAGE DUE TO BEING WALKED ON, PINCHED, OR STRAINED.
- UNPLUG THE APPARATUS DURING LIGHTNING STORMS OR WHEN UNUSED FOR LONG PERIODS OF TIME.
- ONLY USE ATTACHMENTS, ACCESSORIES, STANDS, OR BRACKETS SPECIFIED BY THE MANUFACTURER FOR SAFE OPERATION AND TO AVOID INJURY.
- WARNING: TO REDUCE THE RISK OF ELECTRIC SHOCK OR FIRE, DO NOT EXPOSE THIS UNIT TO RAIN OR MOISTURE..
- SERVICE MUST BE PERFORMED BY QUALIFIED PERSONNEL.
- OUR AMPLIFIERS ARE CAPABLE OF PRODUCING HIGH SOUND PRESSURE LEVELS. CONTINUED EXPOSURE TO HIGH SOUND PRESSURE LEVELS CAN CAUSE PERMANENT HEARING IMPAIRMENT OR LOSS. USER CAUTION IS ADVISED AND EAR PROTECTION IS RECOMMENDED IF UNIT IS OPERATED AT HIGH VOLUME.



EXPLANATION OF GRAPHICAL SYMBOLS:

EXPLICACION DE SIMBOLOS GRAFICOS:

EXPLICATION DES SYMBOLES GRAPHIQUES:



"DANGEROUS VOLTAGE"

"VOLTAJE PELIGROSO"

"DANGER HAUTE TENSION"



"IT IS NECESSARY FOR THE USER TO REFER TO THE INSTRUCTION MANUAL"

"ES NECESARIO QUE EL USUARIO SE REFIERA AL MANUAL DE INSTRUCCIONES."

"REFERREZ-VOUS AU MANUAL D'UTILISATION"

The Digital Signal Processor:

Crate's Digital Signal Processing offers 16 exciting digital effects, accessible through the DSP Mode control. The effects are described below.

1	small room reverb
2	medium room reverb
3	large room reverb
4	concert hall reverb
5	short slapback w/small room reverb
6	medium delay w/plate reverb
7	long delay w/large room reverb
8	slow deep flange w/reverb
9	flange w/reverb & delay
10	slow tremolo chorus w/reverb
11	chorus w/reverb & delay
12	rotating speaker
13	octave divider
14	touch wah
15	inverse wah
16	doubler



The DSP control panel features two knobs with red markings. The left knob is labeled 'LEVEL' and the right knob is labeled 'MODE'. Below the knobs is a text box that reads: "Use the DSP Mode control to access any of the 16 built-in digital effects. Use the Level control to mix in the desired amount of each effect."

Channel Tracking:

Your Crate GLX amplifier gives you the power of **Channel Tracking!** Once you select a DSP setting for each channel, Channel Tracking recalls those DSP settings automatically – without changing the DSP controls! For example:

- Select the Clean channel. Set the DSP Mode to “8” (*slow deep flange w/reverb*)
- Select the Overdrive channel, Gain 1. Set the DSP Mode to “10” (*slow tremolo chorus w/reverb*)
(the setting for the Clean channel is now saved to memory)
- Select the Overdrive channel, Gain 2. Set the DSP Mode to “14” (*touch wah*)
(the setting for the Overdrive channel, Gain 1 is now saved to memory)
- Reselect the Clean channel (the setting for the Overdrive channel, Gain 2 is now saved to memory)

Now when you go back to the Clean channel, even though the DSP Mode was last set to Touch Wah, Channel Tracking automatically recalls the last setting for the Clean channel – in this example, Slow Deep Flange with Reverb. Change to the Overdrive channel, Gain 1, and Slow Tremolo Chorus with Reverb is recalled. Change to the Overdrive channel, Gain 2, and Touch Wah is recalled. That's the power of **Channel Tracking!**

(Note: Even when the power is turned off, **Channel Tracking** still retains the settings – until **you** change them!)

CRATE *GLX65/120/212* Guitar Amplifier with DSP & Channel Tracking

The Front Panel:

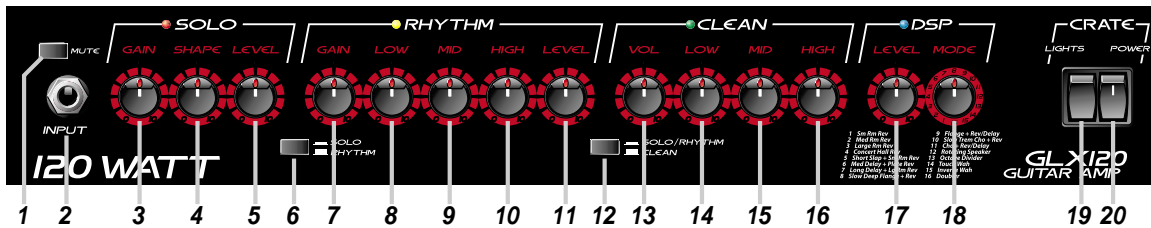

1: MUTE: This switch, when depressed, silences the input signal. The Tuner (#21) remains active when this switch is depressed.

2. INPUT: Use this 1/4" jack to connect your guitar to the amplifier by means of a shielded instrument cable.

SOLO CHANNEL: A high gain channel giving you sounds with serious overdrive.

3: GAIN: Use this control to adjust the amount of distortion for the Solo channel.

4: SHAPE: Use this control to "dial in" the tone for the Solo channel. Rotating the control counterclockwise enhances the mid frequencies, while rotating the control clockwise enhances the low and high frequencies.

5: LEVEL: Use this control to adjust the output level of the Solo channel.

6: SOLO/RHYTHM SELECT: Use this switch to select the Solo or Rhythm channel. When this switch is depressed, the Solo channel is selected. With the switch in the out position, the Rhythm channel is selected. This switch is active only when the Solo-Rhythm/Clean Select switch (#12) is depressed.

7: GAIN: Use this control to adjust the amount of distortion for the Rhythm channel.

8: LOW: Use this control to adjust the low frequency level of the Rhythm channel.

9: MID: Use this control to adjust the midrange frequency level of the Rhythm channel.

10: HIGH: Use this control to adjust the high frequency level of the Rhythm channel.

11: LEVEL: Use this control to adjust the output level of the Rhythm channel.

12: SOLO-RHYTHM/CLEAN SELECT: Use this switch to select the Clean channel or the Solo and Rhythm channels. With the switch in the out position, the Clean channel is selected. When the switch is depressed, either the Solo or Rhythm channel is selected, depending on the setting of the Solo/Rhythm Select switch (#6).

CLEAN CHANNEL: A normal gain channel designed to give you crystal clean sounds.

13: VOL: Use this control to adjust the output level of the Clean channel.

14: LOW: Use this control to adjust the low frequency level of the Clean channel.

15: MID: Use this control to adjust the midrange frequency level of the Clean channel.

16: HIGH: Use this control to adjust the high frequency level of the Clean channel.

17: DSP LEVEL: Use this control to adjust the amount of digital effect: in its fully counterclockwise position the signal will be "dry" (without any effect). As you rotate the control clockwise the amount of effect increases.

18: DSP MODE: Use this control to select one of the 16 built-in digital effects. A listing of the effects is shown on page 3 of this manual.

19: LIGHTS: Use this switch to turn the front panel illumination on (top of the switch depressed) and off (bottom of the switch depressed).

20: POWER: Use this switch to turn the amplifier on (top of the switch depressed) and off (bottom of the switch depressed).

The Electronic Tuner:

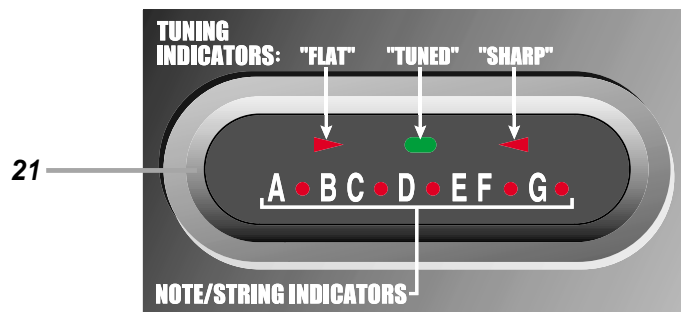

21. ELECTRONIC TUNER (top panel): The electronic tuner is active whenever the amplifier is turned on, providing constant, “real-time” tuning. The bottom row of LEDs indicate which note (string) is being tuned. The top row of LEDs provides directional queues to facilitate quick and precise tuning of your instrument. The indicated note (string) is properly tuned when only the center LED is illuminated.

The Rear Panel:

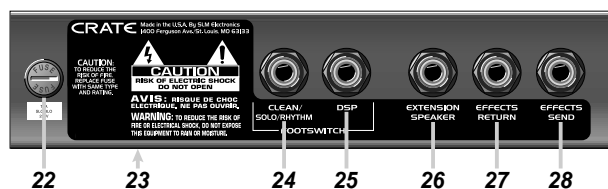

22: FUSE: The fuse protects the amplifier from damages caused by a faulty AC power source and/or other problems. If the fuse opens, replace it **ONLY** with the same size and type. If fuses continue to fail, check the AC source – if the source is okay, contact your Crate dealer for service information.

23: AC LINE CORD: This grounded power cord is to be plugged into a grounded power outlet, wired to current electrical codes and compatible with the voltage, power, and frequency requirements stated on the rear panel. **Do not attempt to defeat the safety ground connection.**

24: CLEAN/SOLO/RHYTHM FOOTSWITCH JACK: Use this jack to connect the 1/4” stereo plug on the footswitch cable to the three-button footswitch (supplied). This allows you to remotely switch between the Clean and Distortion channels and between the Solo and the Rhythm channels.

25: DSP FOOTSWITCH JACK: Use this jack to connect the 1/4” mono plug on the footswitch cable to the three-button footswitch (supplied). This allows you to remotely turn the DSP function on and off.

26. EXTENSION SPEAKER: Use this jack to connect the amplifier to an external speaker cabinet. This jack is wired in series with the internal speaker(s) which remain active when an extension speaker is connected.

27. EFFECTS RETURN: Use this jack to connect the signal from an external effects device to the amplifier.

28. EFFECTS SEND: Use this jack to connect the signal from the amplifier to an external effects device for processing.

CRATE GLX65/120/212 Guitar Amplifier with DSP & Channel Tracking

Suggested Settings:

Sweet 'n Clean:

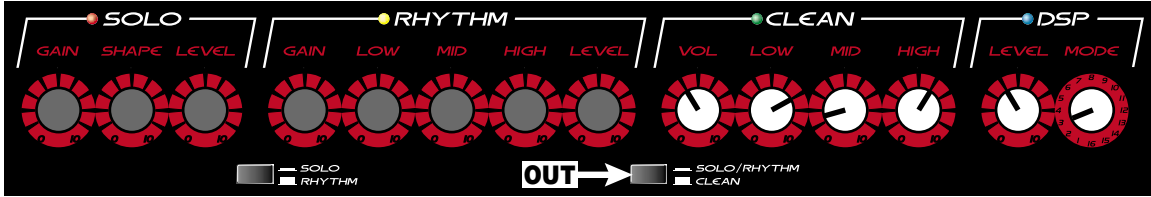

Just a 'Lil Nasty:

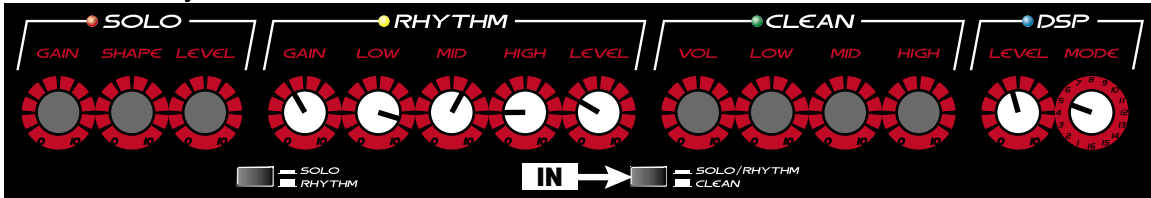

Politely Gritty:

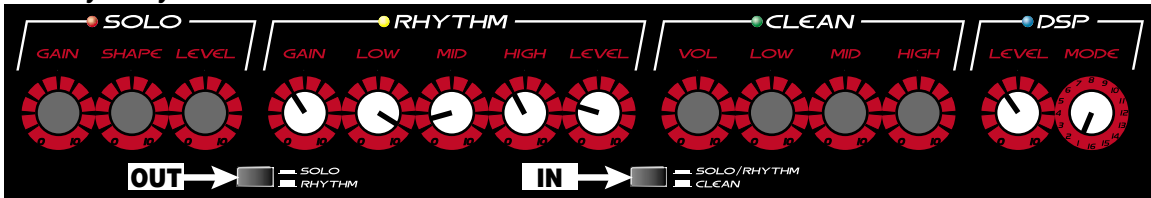

Octave Down 'n Dirty:

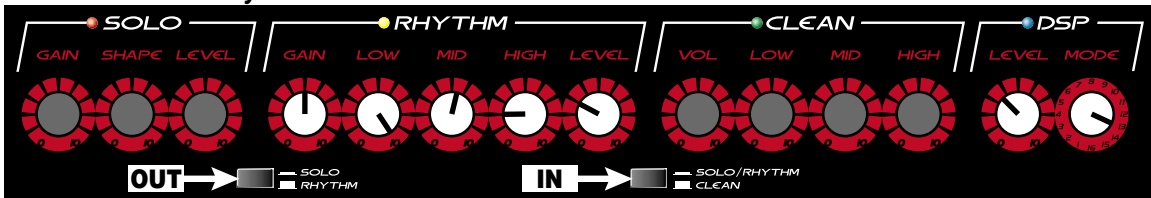

Wah Full House:

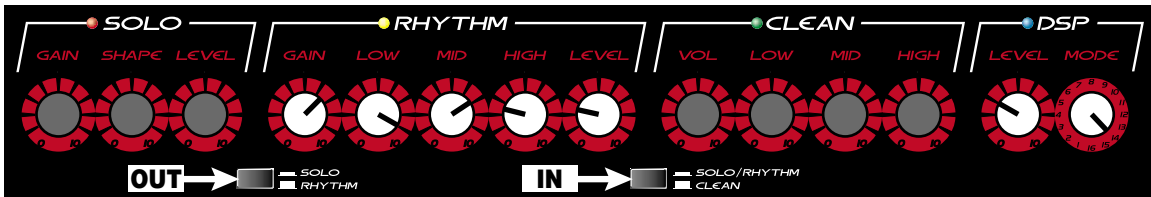

Mean & Obscene:

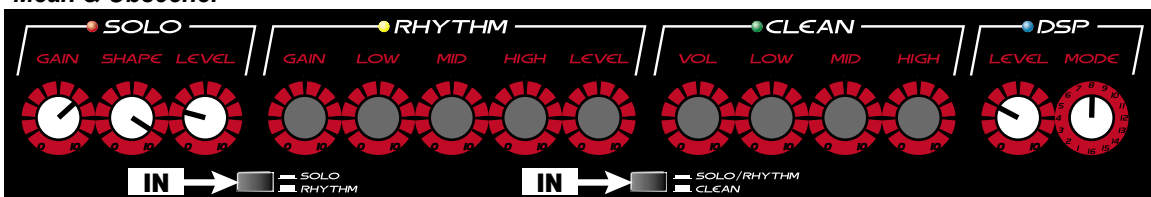

System Block Diagram:

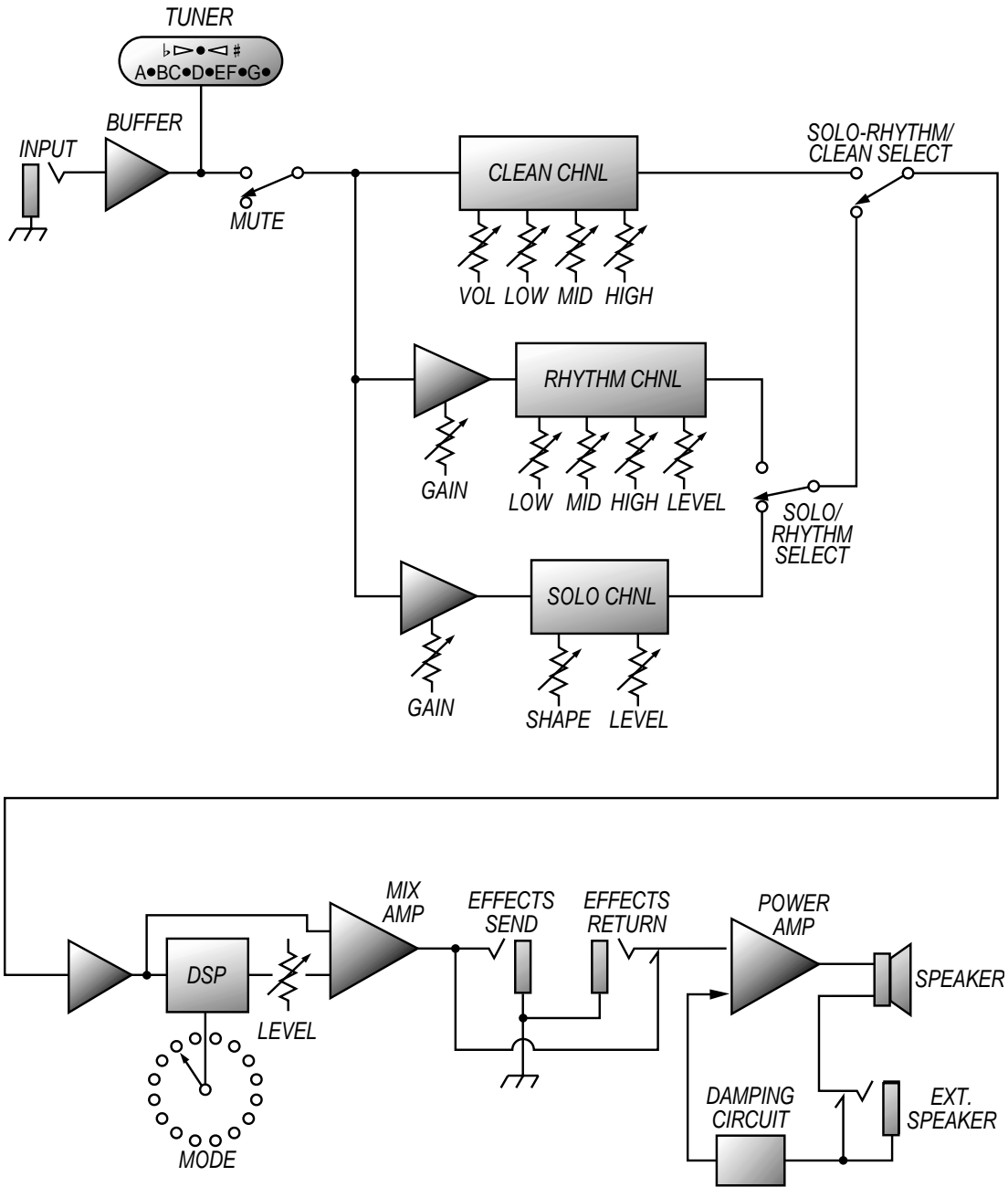

CRATE **GLX65/120/212** Guitar Amplifier with DSP & Channel Tracking

GLX65/120/212 TECHNICAL SPECIFICATIONS:

Output Power Rating	GLX65	65W RMS @ 5% THD, 8Ω, 120 VAC
	GLX120/212	120W RMS @5% THD, 4Ω, 120 VAC
Speaker Size and Rating	GLX65/120	(1) Custom Design 12", 8Ω
	GLX212	(2) Custom Design 12", 8Ω
Input Impedance		470kΩ
Total System Gain	Solo Ch	110dB, all controls @10
	Rhythm Ch	88dB, all controls @10
	Clean Ch	58dB, all controls @10
Maximum Input Signal Accepted		7 volts peak-to-peak
Solo Channel	Shape Control	Proprietary Circuit
Rhythm Channel	Low Control	20dB range @ 80Hz
	Mid Control	15dB range @ 1kHz
	High Control	20dB range @ 10kHz
Clean Channel	Low Control	36dB range @ 80Hz
	Mid Control	15dB range @ 800Hz
	High Control	40dB range @ 10kHz
Power Requirements	GLX65	120 VAC, 60Hz, 90VA; 100/115VAC, 50/60Hz, 90VA; 100/115VAC, 50/60Hz, 90VA
	GLX120/212	120 VAC, 60Hz, 95VA; 100/115VAC, 50/60Hz, 95VA; 100/115VAC, 50/60Hz, 95VA
Size and Weight	GLX65/120	18" H x 20-1/2" W x 12-1/2" D, 34 lbs.
	GLX212	20-1/2" H x 26-1/2" W x 13" D. 50 lbs.

Your GLX65, 120, or 212 is covered with a durable Tolex material: wipe it clean with a lint-free cloth. Never spray cleaning agents onto the cabinet. Avoid abrasive cleansers which would damage the finish.

Crate continually develops new products, as well as improves existing ones. For this reason, the specifications and information in this manual are subject to change without notice.

Declaration Of Conformity

#34, Effective 01-01-2001

Manufacturer's Name: SLM Electronics
Production Facility: 11880 Borman Drive, St. Louis, MO 63146, USA
Production Facility: 700 Hwy 202 W, Yellville, AR 72687, USA
Shipping Facility: 1400 Ferguson Ave., St. Louis, MO 63133, USA
Office Facility: 1400 Ferguson Ave., St. Louis, MO 63133, USA

Product Type: Audio Amplifier

Complies with the following Standards:
Safety: EN60065, E60065, C22.2, UL6500 and/or UL813
EMC: Directive 89/336/EEC, EN55103, EN55013, EN61000, and/or FCC 47CFR 15B cIA

Supplementary information provided by:
 SLM Electronics - R & D Engineering
 1901 Congressional Drive, St Louis, MO 63146, USA
 Tel.: 314-569-0141, Fax: 314-569-0175



www.crateamps.com



©2002 SLM Electronics, a division of St. Louis Music, Inc • 1400 Ferguson Avenue • St. Louis, MO 63133
 47-274-01 • 030603

Free Manuals Download Website

<http://myh66.com>

<http://usermanuals.us>

<http://www.somanuals.com>

<http://www.4manuals.cc>

<http://www.manual-lib.com>

<http://www.404manual.com>

<http://www.luxmanual.com>

<http://aubethermostatmanual.com>

Golf course search by state

<http://golfingnear.com>

Email search by domain

<http://emailbydomain.com>

Auto manuals search

<http://auto.somanuals.com>

TV manuals search

<http://tv.somanuals.com>