

**Owner's Manual
for the
Stealth GT-100H
All Tube 100 Watt Professional Series
Guitar Amplifier**



**"Serious equipment for the
serious musician."**

MADE WITH PRIDE IN THE USA

by

CRATE®



Congratulations!

Your love of performing and driving ambition to be the best have brought you to a turning point in your musical career: the Stealth GT-100H Professional Series guitar amplifier. An all-tube, 100 watt powerhouse of an amplifier designed to take you to the top. And keep you there.

We know something about you: we know you were never impressed with those "toys" that some of your friends called amplifiers. We know you were holding out until *someone* offered you an American-made, affordable piece of professional equipment you could really sink your teeth into. A serious amplifier, designed for a serious musician: an amp with the sounds you've always looked for, the power you've always dreamed about, and the reliability you know you'll need. And all with a name you *know* you can trust: **CRATE**.

Like all Crate products, your Stealth GT-100H is made with pride in America, using only the best components. Extensive testing at the hands and ears of skilled technicians and musicians insures you that this amplifier is the absolute best it can be.

In order to get the most out of your new amplifier, we strongly urge you to go over the information contained in this manual before you begin playing.

And **thank you** for choosing **CRATE**®

CONTENTS:	
About the Stealth GT-100H	2
The GT-100H Front Panel:	3
The GT-100H Rear Panel:	6
Some Suggested Settings:	7
A Word About Tubes :	8
System Block Diagram:	9
Technical Specifications:	10

CAUTION

RISK OF ELECTRIC SHOCK
DO NOT OPEN

CAUTION: TO REDUCE THE RISK OF ELECTRIC SHOCK, DO NOT REMOVE COVER. NO USER-SERVICEABLE PARTS INSIDE. REFER SERVICING TO QUALIFIED SERVICE PERSONNEL.

ATTENTION

RISQUE D'ÉLECTROCUTION
NE PAS OUVRIR

ATTENTION: POUR RÉDUIRE LES RISQUES D'ÉLECTROCUTION, NE PAS ENLEVER LE COUVERCLE. AUCUNE PIÈCE INTÉRIEURE N'EST RÉPARABLE PAR L'UTILISATEUR. POUR TOUTE RÉPARATION, S'ADRESSER À UN TECHNICIEN QUALIFIÉ.

VORSICHT

ELEKTRISCHE SCHLAGGEFÄHR
NICHT ÖFFNEN

VERBODT: ZUR MINDERUNG ELEKTRISCHER SCHLAGGEFÄHR NICHT DEN DECKEL ABNEHMEN. INNERE TEILE KÖNNEN NICHT VOM BENUTZER GEWARTET WERDEN. DIE WARTUNG IST QUALIFIZIERTEM WARTUNGSPERSONAL ZU ÜBERLASSEN.

THIS EQUIPMENT HAS BEEN DESIGNED AND ENGINEERED TO PROVIDE YEARS OF SAFE AND RELIABLE OPERATION. IN ORDER TO PROLONG THE LIFE OF THE UNIT AND PREVENT ACCIDENTAL DAMAGES OR INJURY, PLEASE FOLLOW THESE PRECAUTIONARY GUIDELINES:

- WARNING:** TO REDUCE THE RISK OF ELECTRIC SHOCK:
- (1) DO NOT OPEN CHASSIS.
 - (2) DO NOT DEFEAT OR REMOVE THE GROUND PIN OF THE POWER CORD.
 - (3) CONNECT ONLY TO A PROPERLY GROUNDED AC POWER OUTLET.

CAUTION: TO REDUCE THE RISK OF FIRE OR ELECTRIC SHOCK, DO NOT EXPOSE THIS EQUIPMENT TO RAIN OR MOISTURE.

CAUTION: NO USER SERVICEABLE PARTS INSIDE. REFER SERVICING TO QUALIFIED SERVICE PERSONNEL.

IF THIS AMPLIFIER GETS DROPPED, HAS LIQUIDS SPILLED INTO IT OR SUSTAINS DAMAGE TO ITS CONTROLS OR POWER CORD, DISCONTINUE USE AND HAVE IT INSPECTED AT AN AUTHORIZED SERVICE CENTER.

NEVER TURN THIS AMPLIFIER ON UNLESS IT IS CONNECTED TO A SPEAKER. ALWAYS SET THE IMPEDANCE SELECTOR TO THE PROPER SETTING. SEE PAGE 5 OF THIS MANUAL.

CAUTION: OUR AMPLIFIERS ARE CAPABLE OF PRODUCING HIGH SOUND PRESSURE LEVELS. CONTINUED EXPOSURE TO HIGH SOUND PRESSURE LEVELS CAN CAUSE PERMANENT HEARING IMPAIRMENT OR LOSS. USER CAUTION IS ADVISED, AND EAR PROTECTION IS RECOMMENDED IF UNIT IS OPERATED AT HIGH VOLUME.

THE CHART BELOW SHOWS THE U.S. GOVERNMENT'S OCCUPATIONAL SAFETY AND HEALTH ADMINISTRATION (OSHA) REGULATIONS FOR PERMISSIBLE NOISE EXPOSURE, PER 29CFR1910.95, TABLE G-16.

SOUND LEVEL dBA, SLOW RESPONSE	DURATION PER DAY IN HOURS
90	8
92	6
95	4
97	3
100	2
102	1-1/2
105	1
110	1/2
115	1/4 or less

ACCORDING TO OSHA, ANY EXPOSURE IN EXCESS OF THESE AMOUNTS LISTED ABOVE COULD RESULT IN SOME HEARING LOSS.

EXPLANATION OF GRAPHICAL SYMBOLS:

- : "DANGEROUS VOLTAGE"
- : "IT IS NECESSARY FOR THE USER TO REFER TO THE INSTRUCTION MANUAL"

ABOUT THE STEALTH GT-100H:

The Crate GT-100H is an all-tube, feature-packed professional stage amp, with three different sound and level settings readily available at the touch of a footswitch. Rugged construction, reliable American craftsmanship and 100 watts of pure tube power are trademarks of this new and impressive piece of professional musicians' equipment. The GT-100H features two distinctly different 12AX7 tube driven channels: one with the classic tube rhythm sounds and one offering you some of the finest lead and overdrive sounds of any amplifier.

Each channel features an all-tube preamp section with input attenuators and three bands of EQ for total tone control. In addition, Channel 2 also gives you two separate, footswitchable Gain controls which work independently, giving you TWO separate sounds and levels for the 3 tube, 7 gain stage distortion channel.

An easy-access front-panel "Aux In" jack lets you connect a drum machine, tape deck, or CD player right into to the amplifier, allowing your guitar signal to pass from the preamp so you can "rehearse" with the music. Additional features such as an Effects Loop, a Line Out jack and an Extension Speaker jack further increase your possibilities and add to the flexibility and versatility of this unique and extraordinary amplifier.

FEATURES OVERVIEW:

Given below is a quick overview of the GT-100H's features and controls. Additional information can be found on the pages indicated.

All Tube Preamp and Power Amp:

Classic tube sound with Crate's legendary performance and reliability.

Two Completely Separate Channels:

Independent Preamp levels, 3-band EQ's, Reverb and Master levels. (page 3)

Two Gain Controls: (Channel 2)

Footswitchable. Independently adjustable. Almost like getting a third channel. (page 4)

Aux In Jack:

Allows insertion of drum machine or music source. Great for practicing or performing. (page 3)

Total Footswitch Control:

Channel selection. Choice of two Gains for Channel 2. (page 4, page 6))

External Speaker Jack:

Standard 1/4" mono phone jack. Parallel connection. (page 6)

Effects Loop:

1/4" Line Out/Line In jacks. Allows external signal processor connection. (page 6)

Line Out Jack:

Frequency compensated to simulate speaker cabinet. (page 6)

Impedance Selector Switch:

For optimum speaker matching using virtually any cabinet configurations. (page 6)

THE GT-100H FRONT PANEL:

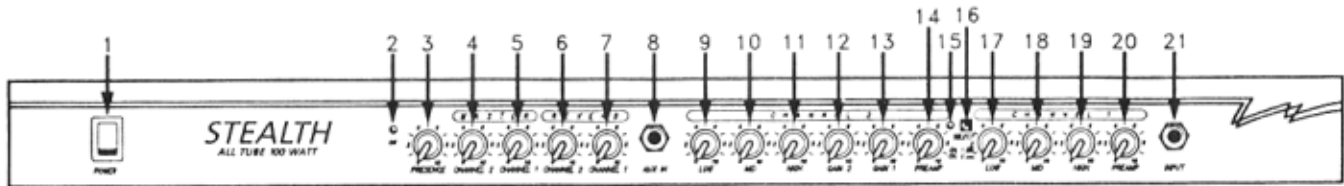

1: POWER: This heavy-duty rocker-type switch is used to turn the amplifier ON in the up position, off in the down position. The Power LED (#2) works with this switch as a visual indicator.

2: POWER LED: This LED glows red when you turn the GT-100H on, showing you that the amplifier is activated and ready to play.

3: PRESENCE: Adjustment of the high-frequency overtones and harmonics can be made with this control, in addition to the settings of each channel's High control. Turning the control to the left reduces the level of high frequency overtones; turning it to the right increases their level. The Presence control provides up to 10dB of boost or cut at 8kHz.

4: MASTER, CHANNEL 2: Adjust the output level of Channel 2 with this control: in its full-left position, little or no signal will pass (depending on the setting of the Preamp control). As you rotate the control to the right you increase the strength of Channel 2's signal going to the power amplifier, thus increasing the output volume. This affects the signal for the Speaker, Line Out, and Effects Loop Send (#23, 24, 25, 27 and 28) simultaneously.

5: MASTER, CHANNEL 1: Adjust the output level of Channel 1 with this control: in its full-left position, little or no signal will pass (depending on the setting of the Preamp control). As you rotate the control to the right you increase the strength of Channel 1's signal going to the power amplifier, thus increasing the output volume. This affects the signal for the Speaker, Line Out, and Effects Loop Send (#23, 24, 25, 27 and 28) simultaneously.

6: REVERB, CHANNEL 2: Adjust the amount of reverb effect for Channel 2 with this control: in the full-left position the signal is "dry" (no reverb). As you rotate the control to the right you increase the amount of reverberation, with maximum reverb effect achieved at the full-right position. Channel 2's reverb circuitry has been designed to give a more traditional reverb effect, without as much bottom end as Channel 1, which is better suited for distortion.

NOTE: When a footswitch is connected (see #26, rear panel) the front-panel switch will have no control over which channel is selected.

7: REVERB, CHANNEL 1: Adjust the amount of reverb effect for Channel 1 with this control: in the full-left position the signal is "dry" (no reverb). As you rotate the control to the right you increase the amount of reverberation, with maximum reverb effect achieved at the full-right position. Channel 1's reverb circuitry has been designed to give a deeper, fatter reverb effect which is best suited for clean sounds.

8: AUX IN: This stereo jack allows you to feed the output of a drum machine, tape or CD player, or other source to the input of the GT-100H's internal power amp. This lets you to perform or practice with a drum machine, or to play along with your favorite artists or other pre-recorded source.

WARNING: The Aux In jack goes directly into the power amp section of the GT-100H, therefore **DO NOT** plug high-level signals into this jack. Keep in mind that the signal will be fed full strength to the amp, so exercise caution and use an input pad if necessary to achieve the desired output level.



Channel 2:

9: LOW: Adjust Channel 2's low frequency output with this control: the center position is "flat," that is, no boost or cut. Turning the control to the left reduces the low frequency output; turning it to the right increases the low frequency output. The Low control provides up to 16dB of boost or cut at 40Hz.

10: MID: Adjust Channel 2's midrange output with this control: in the center position the midrange output will be "flat" (no boost or cut). Turning the control to the left reduces the midrange output; turning it to the right increases the midrange output. The Mid control provides up to 13dB of boost or cut at 500Hz, which affects the "voice" of your guitar's sound.

11: HIGH: Adjust Channel 2's high frequency output with this control: in the center position the high frequency output will be "flat" (no boost or cut). Turning the control to the left reduces the high frequency output; turning it to the right increases the high frequency output. The High control provides up to 16dB of boost or cut at 5kHz, which allows you to adjust the crispness or the "bite" of your guitar.

12: GAIN 2: This allows you to add another setting of tube distortion to Channel 2's signal, independently from the setting of Gain 1. The use and effects of this control on the signal are the same as those of Gain 1, IF a footswitch is being used. Otherwise the amp defaults to Gain 1 ONLY.

NOTE: IF A FOOTSWITCH IS NOT CONNECTED TO THE AMPLIFIER, ONLY GAIN 1 IS ACTIVE: THE SETTINGS OF GAIN 2 WILL HAVE NO EFFECT ON THE SOUND OF YOUR GUITAR. (SEE #12 AND 26)

13: GAIN 1: This allows you to add tube distortion to Channel 2's signal, creating a wide variety of sounds and levels. Use this control along with Channel 2's Preamp and Master Level controls (#14 and 4). (Some suggested settings can be found on page 8.) With this control in the full-left position, the signal goes through without any added distortion or level. As you rotate the control to the right you add distortion and increase the output level of the signal, with maximum tube distortion and volume reached at the full-right position.

NOTE: IF A FOOTSWITCH IS NOT CONNECTED TO THE AMPLIFIER, ONLY GAIN 1 IS ACTIVE: THE SETTINGS OF GAIN 2 WILL HAVE NO EFFECT ON THE SOUND OF YOUR GUITAR. (SEE #12 AND 26)

14: PREAMP: This serves as the gain control for Channel 2's preamp section, giving you total control over the volume setting and amount of tube compression. Use this control along with Channel 2's Master level control (#18). (Some suggested settings can be found on page 7.) With the control to the full-left position, no signal passes through. As you bring the control towards center you increase the signal level and tube compression, until in its full-right position the signal is at full strength, with lots of tube preamp distortion.

15: LED: This LED glows red ONLY when Channel 2 has been activated and works with the front-panel Select switch (#16) or a footswitch (#26).

16: SELECT: Select either Channel 1 (switch in the OUT position) or Channel 2 (switch IN) with this pushbutton switch. The channel indicator LED (#15) will glow red when Channel 2 is selected, serving as a visual guide.

Channel 1:

17: LOW: Adjust Channel 1's low frequency output with this control: the center position is "flat," that is, no boost or cut. By turning the control to the left you reduce the low frequency output; turning it to the right increases the low frequency output. The Low control provides up to 16dB of boost or cut at 40Hz.



* * * *Please refer to the illustration on page 3.* * * *

18: MID: Adjust Channel 1's midrange output with this control: in the center position the midrange output will be "flat" (no boost or cut). Turning the control to the left reduces the midrange output; turning it to the right increases the midrange output. The Mid control provides up to 13dB of boost or cut at 500Hz, which affects the "voice" of your guitar's sound.

19: HIGH: Adjust Channel 1's high frequency output with this control: in the center position the high frequency output will be "flat" (no boost or cut). Turning the control to the left reduces the high frequency output; turning it to the right increases the high frequency output. The High control provides up to 16dB of boost or cut at 5kHz, which allows you to adjust the crispness or the "bite" of your guitar.

20: PREAMP: This serves as the gain control for Channel 1's preamp section, giving you total control over the volume setting and amount of tube compression. Use this control along with Channel 1's Master level control (#5). (Some suggested settings can be found on page 8.) With the control to the full-left position, no signal passes through. As you bring the control towards center you increase the signal level until in its full-right position the signal is at full strength, with a slight amount of clean tube compression.

21: INPUT: Connect your guitar here using a shielded instrument cable.

THE GT-100H REAR PANEL:

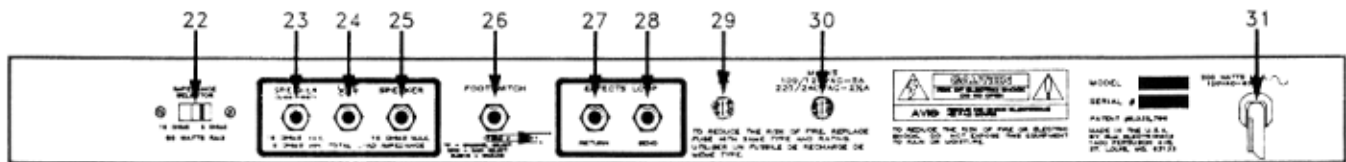

22: IMPEDANCE SELECTOR: For the best performance and least strain on the amplifier, you **MUST** match the impedance of the amp to that of your speaker cabinet(s). Set the selector switch to the 8 ohm or 16 ohm position, depending on the total impedance of your speakers. The chart below can help you figure that impedance based on the following combinations of speakers connected in parallel.

Cab. Imp.	# of Cabs.	Total Imp.
8 ohms	1	8 ohms
16 ohms	1	16 ohms
16 ohms	2	8 ohms

IMPORTANT: Always keep the total impedance at 8 or 16 ohms!

23, 25: SPEAKER: Connect either of these jacks to a single speaker cabinet, or use both to connect to two cabinets. **ONLY** use speaker cabinets with impedances of 8 ohms or higher: see the information on impedance matching under #22, Impedance Selector. Use heavy-duty speaker cables - **NOT** instrument patch cords - to connect to the speaker cabinets. **NOTE:** Use # 23 first.

24: LINE OUT: This supplies a pre-amplified, post-EQ signal to an external amplifier, mixing board or recording console. The jack is an unbalanced mono 1/4" type.

26: FOOTSWITCH: A dual footswitch can be plugged in here to give you remote control for channel selection and for selecting between Gain 1 and Gain 2 for Channel 2. When connected, the footswitch overrides the front panel Select switch (#16).

NOTE: This is a **STEREO 1/4" jack**: "ring" controls the Gains selection, "tip" controls channel selection, "sleeve" is ground for both. Use **ONLY** a stereo-plug equipped footswitch (such as the Crate FS-60).

27: EFFECTS LOOP RETURN: When using an external signal processor, connect a shielded cable between the **OUTPUT** of the effects unit and this jack to complete the loop. This "returns" the processed signal to the internal amplifier of the GT-100H.

28: EFFECTS LOOP SEND: When using an external signal processor with the GT-100H, connect a shielded cable between this jack and the **INPUT** of the effects device. This "sends" the pre-amplified signal to the device for processing.

29: B+ FUSE: This protects the output tubes against damages caused by overload conditions other problems. If the fuse blows, replace it **ONLY** with the same size and type 2A 120V slo-blow fuse. If the fuse blows repeatedly check the AC source: if it's okay, contact your Crate dealer for service information.

30:FUSE: This protects the amplifier against damages caused from a faulty AC power source or other problems. If the fuse blows, replace it **ONLY** with the same size and type 5A 120V slo-blow fuse. If the fuse blows repeatedly check the AC source: if it's okay, contact your Crate dealer for service information.

31: POWER CORD: This heavy-duty, grounded, three wire power cord is to be plugged into **ONLY** a safely-wired, grounded 120 volt, 60 cycle AC power outlet. **DO NOT** attempt to defeat the ground connection of this cable! If your GT-100H was purchased outside of the United States, see the unit's rear panel for its power rating and follow the above guidelines.

SOME SUGGESTED SETTINGS:

CRUNCHY EDGE:

SPARKLING CLEAN:

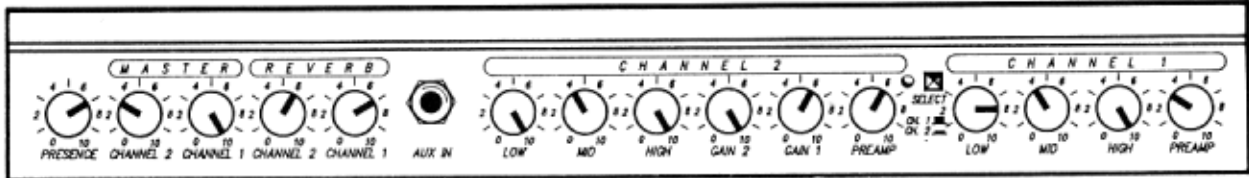

Gain 2 can be set as desired for solos.

ROCK RHYTHM:

FAT CLEAN:

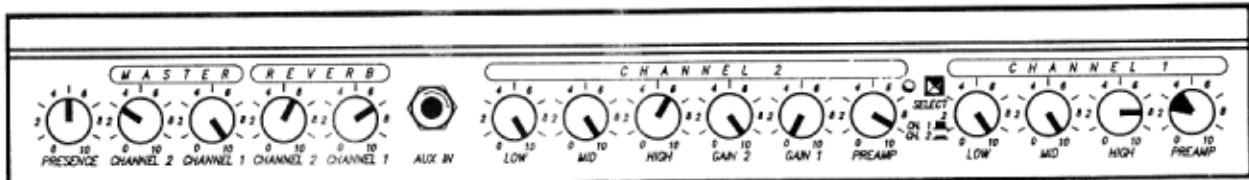

Gain 2 can be set as desired for solos or for more distortion.

BEDROOM SETTINGS:

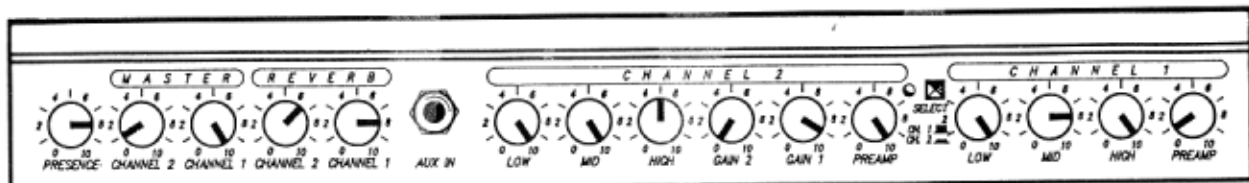

CLUB SETTINGS:

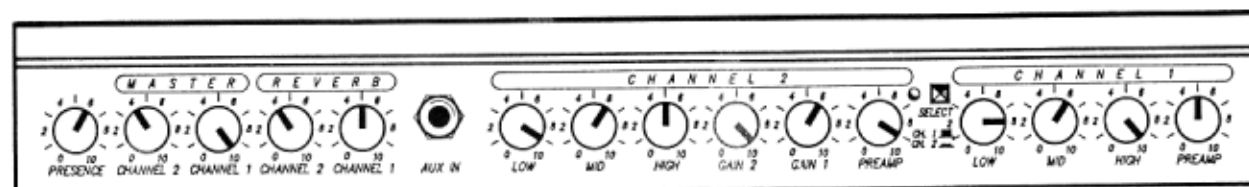

Gain 2 can be set as desired for solos.



A WORD ABOUT TUBES:

Your GT-100H comes equipped from our factory with a set of EL-34 power tubes installed. These high-quality tubes are very popular due to their "British Rock" sound. They distort sooner than most power tubes, providing a more controllable and less penetrating distortion effect when overdriven. Traditional rockers, jazz and R&B players love these kinds of tubes. However, heavy metal players, or players looking for the more traditional "American Rock" sound, may want to take his amp to his authorized Crate service center to have the EL-34's replaced with 6550 power tubes. The 6550's provide lots of clean power, even up to their full output, with lots of dynamic headroom. When overdriven they produce the type of penetrating distortion associated with hard rock and heavy metal music.

NOTE: Tube replacement should always be done by a qualified service center, since adjustment of the internal biasing controls will be necessary after the new tubes are installed.

Vacuum tubes are made up of several mechanical parts encased in a glass housing and are vulnerable to vibrations, heat and other factors which can shorten their lifespans. When power tubes wear out, the amplifier will begin to grow weak, lack punch, fade up and down, or lose highs and lows. Power tubes work together in a push/pull configuration and should all be replaced at the same time with matched or balanced tubes. There are different grades of power tubes, offering different levels of performance. There are even sets of tubes available that have been extensively tested and matched together for optimum performance and tube life. Your dealer can recommend the best replacement tubes for your amplifier.

Preamp tubes aren't worked as hard as power tubes and typically last longer. When a preamp tube wears out, the amplifier may squeal, get noisy, lose gain and sensitivity, or just quit working. The service center can determine which tube(s) may need replacing.

Your GT-100H uses the finest tubes available in its preamp and power amp circuits, to provide outstanding sound and performance. In order to keep your amplifier performing at its peak, observe the following guidelines:

- Match the impedance of your speaker cabinet(s) to the amplifier. Improper impedance matching will contribute tube wear and is a leading cause of premature tube death.
- In cold weather, allow the amplifier to warm up to room temperature before turning it on. Cold glass tube casings tend to crack when the heat from the tube hits them.
- Allow the amplifier to cool off after playing before you move it. This lets the internal components of the tubes cool down, making them less susceptible to damages caused by vibrations, thus prolonging their lives.
- Replace output tubes on a regular basis, before trouble starts. Typically, this means at least once a year. If you play long and hard, every day, this could mean as often as every 4 to 6 months.
- Always have the amplifier's biasing checked after replacing the output tubes. This should be done ONLY at a qualified service center. Improper biasing could result in the tubes running too hot - characterized by the large gray plates inside the tubes glowing red from the heat and the sound from the amplifier lacking punch - or too cold - distorted sound regardless of level settings and a lack of power from the amp. Do not play the amplifier if it exhibits these symptoms - get the bias adjusted to prevent tube failure or other damage.
- Let the amplifier idle (power on, no signal) for 5 to 10 minutes after new tubes are installed, to let them stabilize before using the amplifier.
- Protect the amplifier from exposure to dust and moisture. If liquids get spilled into the amplifier, or if the amplifier gets dropped or excessively jarred, have it checked out at a service center before using it.

◆ Proper maintenance and cleaning combined with regular trips to your service center will insure the best performance and longest life from your amplifier.

SYSTEM BLOCK DIAGRAM:

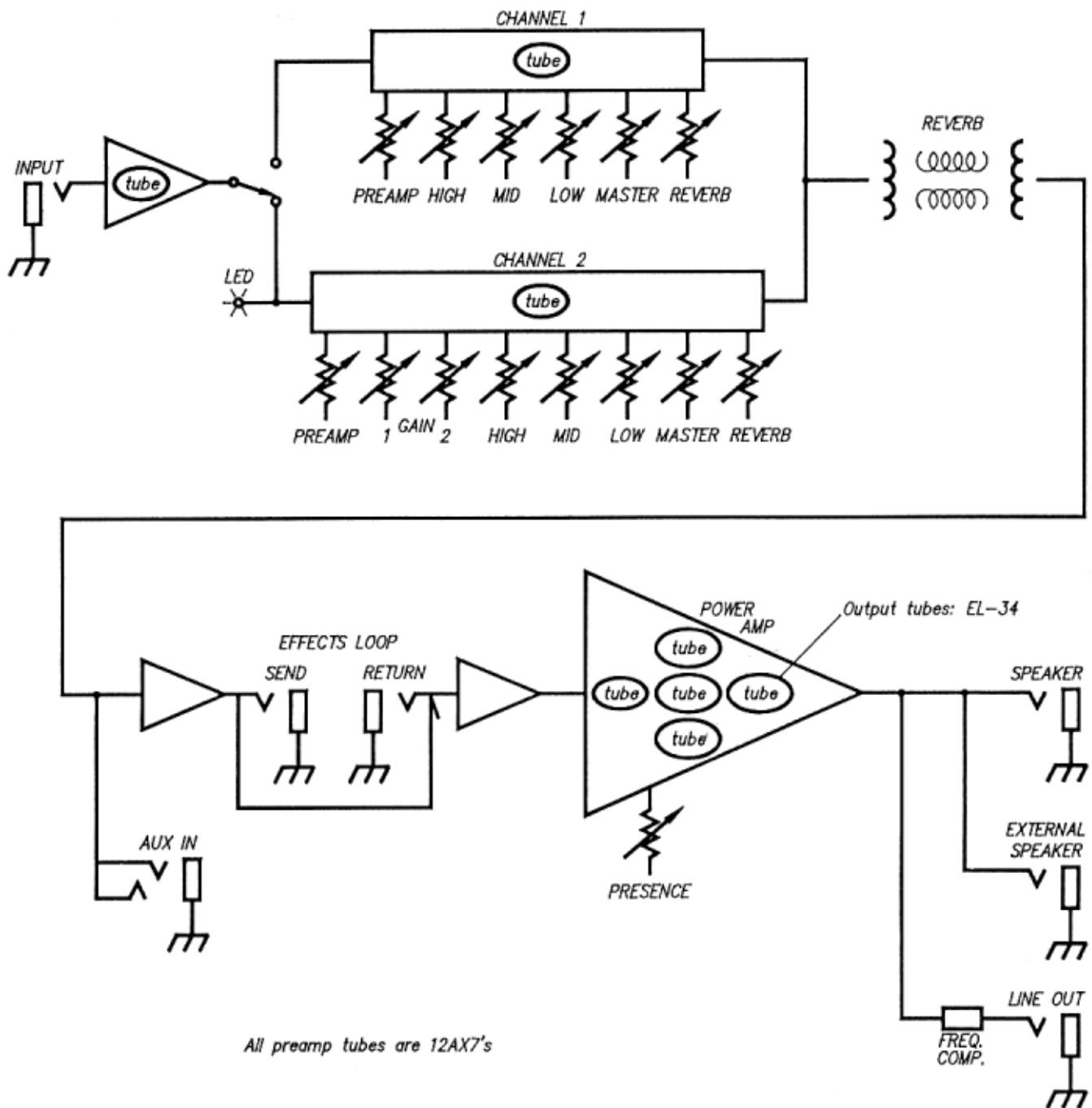

**GT-100H TECHNICAL SPECIFICATIONS:**

Output Power Rating		100 watts RMS @5% THD 8 ohm load, 120VAC
Gain	Channel 1	60dB, tones at "5" @ 1kHz
	Channel 2	78dB, tones at "5" @ 1kHz
Tone Control Range	Channel 1	
	Low	16dB @ 40Hz
	Mid	13dB @ 316Hz
	High	16dB @ 5kHz
	Channel 2	
	Low	16dB @ 40Hz
	Mid	16dB @ 500Hz
	High	12dB @ 5kHz
	Presence	10dB @ 8kHz
Signal to Noise Ratio	Channel 1	-55dB, all controls @ "10"
	Channel 2	-52dB, all controls @ "10"
Input Impedance		0dB/1m ohm
Maximum Signal Accepted		2V peak to peak
Tube Type	Preamp	12AX7 (3)
	Power Amp	EL-34 (4) (6550 compatible)
Line Out Level		4.5V RMS @ 1kHz
Fuses	Mains	5A Slo-Blow
	B+	2A Slo-Blow
Size and Weight		11.625"H x 30.75"W x 11"D 45 lbs.

The GT-100H is covered with a high-quality carpet-like material; brush clean as needed. Never spray cleaning agents directly onto the cabinet, and stay away from abrasive cleaners which could damage the finish.

Crate continually develops new products, as well as improves existing ones. For this reason, the specifications and information in this Crate manual are subject to change without notice.

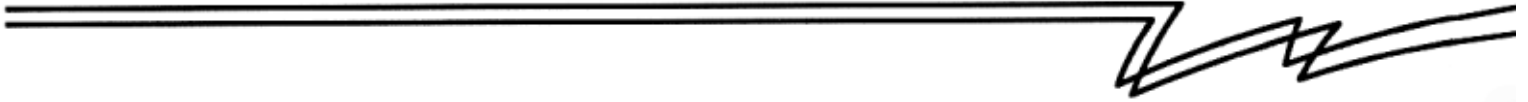

CRATE[®]

CRATE/SLM ELECTRONICS, A DIVISION OF ST. LOUIS MUSIC, 1400 FERGUSON, ST. LOUIS, MO. 63133
P/N 47-631-01



Free Manuals Download Website

<http://myh66.com>

<http://usermanuals.us>

<http://www.somanuals.com>

<http://www.4manuals.cc>

<http://www.manual-lib.com>

<http://www.404manual.com>

<http://www.luxmanual.com>

<http://aubethermostatmanual.com>

Golf course search by state

<http://golfingnear.com>

Email search by domain

<http://emailbydomain.com>

Auto manuals search

<http://auto.somanuals.com>

TV manuals search

<http://tv.somanuals.com>