

CRATE

GT120HL

Three-Channel Guitar Amplifier



User's Guide

CRATE *GT120HL* Three-Channel Guitar Amplifier

TABLE OF CONTENTS:

Introduction	3
The Front Panel	4
The Rear Panel	5
Suggested Settings	6
System Block Diagram	7
Technical Specificationsback cover

	CAUTION RISK OF ELECTRIC SHOCK DO NOT OPEN	
<small>WARNING: TO REDUCE THE RISK OF FIRE OR ELECTRIC SHOCK, DO NOT EXPOSE THIS APPARATUS TO RAIN OR MOISTURE. TO REDUCE THE RISK OF ELECTRIC SHOCK, DO NOT REMOVE COVER. NO USER-SERVICEABLE PARTS INSIDE. REFER SERVICING TO QUALIFIED SERVICE PERSONNEL.</small>		

	PRECAUCION RIESGO DE CORRIENTAZO NO ABRA	
<small>PRECAUCION: PARA REDUCIR EL RIESGO DE INCENDIOS O DESCARGAS ELECTRICAS, NO PERMITA QUE ESTE APARATO QUEDA EXPUESTO A LA LLUVIA O LA HUMEDAD. PARA DISMINUIR EL RIESGO DE CORRIENTAZO, NO ABRA LA CUBIERTA. NO HAY PIEZAS ADENTRO QUE EL USUARIO PUEDE REPARAR DEJE TODO MANTENIMIENTO A LOS TECNICOS CALIFICADOS.</small>		

	ATTENTION RISQUE D'ELECTROCUTION NE PAS OUVRIR	
<small>ATTENTION: PROTEGEZ CET APPAREIL DE LA PLUIE ET DE L'HUMIDITE AFIN D'EVITER TOUT RISQUE D'INCENDIE OU D'ELECTROCUTION. POUR REDUIRE D'ELECTROCUTION NE PAS ENLEVER LE COUVERCLE. AUCUNE PIECE INTERNE N'EST REPRABLE PAR L'UTILISATEUR. POUR TOUTE REPARATION, S'ADRESSER A UN TECHNICIEN QUALIFIE.</small>		

IMPORTANT SAFETY INSTRUCTIONS

- READ, FOLLOW, HEED, AND KEEP ALL INSTRUCTIONS AND WARNINGS.
- DO NOT OPERATE NEAR ANY HEAT SOURCE AND DO NOT BLOCK ANY VENTILATION OPENINGS ON THIS APPARATUS. FOR PROPER OPERATION, THIS UNIT REQUIRES 3" (75mm) OF WELL VENTILATED SPACE AROUND HEATSINKS AND OTHER AIR FLOW PROVISIONS IN THE CABINET.
- DO NOT USE THIS APPARATUS NEAR SPLASHING, FALLING, SPRAYING, OR STANDING LIQUIDS.
- CLEAN ONLY WITH LINT-FREE DAMP CLOTH AND DO NOT USE CLEANING AGENTS.
- ONLY CONNECT POWER CORD TO A POLARIZED, SAFETY GROUNDED OUTLET WIRED TO CURRENT ELECTRICAL CODES AND COMPATIBLE WITH VOLTAGE, POWER, AND FREQUENCY REQUIREMENTS STATED ON THE REAR PANEL OF THE APPARATUS.
- PROTECT THE POWER CORD FROM DAMAGE DUE TO BEING WALKED ON, PINCHED, OR STRAINED.
- UNPLUG THE APPARATUS DURING LIGHTNING STORMS OR WHEN UNUSED FOR LONG PERIODS OF TIME.
- ONLY USE ATTACHMENTS, ACCESSORIES, STANDS, OR BRACKETS SPECIFIED BY THE MANUFACTURER FOR SAFE OPERATION AND TO AVOID INJURY.
- WARNING: TO REDUCE THE RISK OF ELECTRIC SHOCK OR FIRE, DO NOT EXPOSE THIS UNIT TO RAIN OR MOISTURE.
- SERVICE MUST BE PERFORMED BY QUALIFIED PERSONNEL.
- OUR AMPLIFIERS ARE CAPABLE OF PRODUCING HIGH SOUND PRESSURE LEVELS. CONTINUED EXPOSURE TO HIGH SOUND PRESSURE LEVELS CAN CAUSE PERMANENT HEARING IMPAIRMENT OR LOSS. USER CAUTION IS ADVISED AND EAR PROTECTION IS RECOMMENDED IF UNIT IS OPERATED AT HIGH VOLUME.
- WARNING: THIS UNIT REQUIRES A SAFETY GROUNDED OUTLET WIRED TO CURRENT ELECTRIC CODES HAVING THE LINE SUPPLY VOLTAGE, POWER, AND FREQUENCY IDENTIFIED ON THE REAR OF THE UNIT. THE OUTLET MUST REMAIN ACCESSIBLE TO DISCONNECT THE UNIT IF A FAULT SHOULD ARISE WHILE IN USE. THIS UNIT SHOULD BE UNPLUGGED WHEN NOT IN USE.



EXPLANATION OF GRAPHICAL SYMBOLS:

EXPLICACION DE SIMBOLOS GRAFICOS:

EXPLICATION DES SYMBOLES GRAPHIQUES:



=

"DANGEROUS VOLTAGE"
"VOLTAJE PELIGROSO"
"DANGER HAUTE TENSION"



=

"IT IS NECESSARY FOR THE USER TO REFER TO THE INSTRUCTION MANUAL"
"ES NECESARIO QUE EL USUARIO SE REFIERA AL MANUAL DE INSTRUCCIONES."
"REFERREZ-VOUS AU MANUAL D'UTILISATION"

CRATE *GT120HL* Three-Channel Guitar Amplifier

Congratulations!

You are now the proud owner of the Crate GT120HL three-channel guitar amplifier. This rugged amplifier combines outstanding features with serious clean and distorted sounds and boasts a uniquely illuminating front piece. Front panel RCA input jacks allow you to play along with your favorite CD or tape. The rear panel Insert Jack allows you to connect your effects for greater flexibility. Channel switching and reverb may be controlled by means of a footswitch.

Like all Crate products, your GT120HL amplifier is designed by musicians, and built using only the best components. Extensive testing confirms that this amplifier is the absolute best it can be.

In order to get the most out of your new amplifier, we strongly urge you to read the information contained in this manual before you begin playing.

And **thank you** for choosing Crate.

Declaration of Conformity

Manufacturer's Name: SLM Electronics

Corporate Headquarters: 1901 Congressional Drive, St. Louis, Missouri 63146

Primary Production Facility: 700 Hwy 202 W, Yellville, Arkansas, 72687

Product Type: Audio Amplifier

Products meet the regulations for compliance marking under:

ETL standards UL6500, UL60065, or UL813

CSA standards E60065 or C22.2 No.1-M90

CE safety standard EN60065

CE EMC standards EN55103 or EN55013 and EN61000

FCC standards 47CFR 15.107 and 15.109 Class A

C-tick designation Level 2, ABN #56748810738, ARBN# N222

KETI standard K60065 (limited model approval)

Compliance Support Contact: SLM Electronics, Attn: R&D Compliance Engineer
1901 Congressional Drive, St Louis, Missouri, 63146 • Tel.: 314-569-0141, Fax: 314-569-0175

CRATE *GT120HL* Three-Channel Guitar Amplifier

The Front Panel:

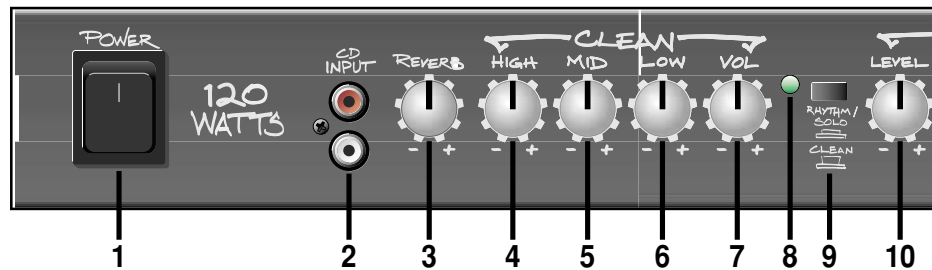

1: POWER: Use this switch to turn the amplifier on (top of the switch depressed) and off (bottom of the switch depressed). The front of the amplifier illuminates when the power is on.

2: CD INPUT: Use these RCA jacks to connect the output from a CD player or tape deck to the amplifier. The signal at these jacks is combined into a mono signal which is sent to the internal power amp circuit. Use the CD or tape player's output level control to adjust the signal for the proper mix with your guitar.

3: REVERB: Use this control to adjust the amount of reverb effect: in its fully counterclockwise position the signal will be "dry" (without any effect). As you rotate the control clockwise the amount of reverb increases.

CLEAN CHANNEL: A normal gain channel designed to give you crystal clean sounds.

4: HIGH: Use this control to adjust the high frequency level of the Clean channel.

5: MID: Use this control to adjust the midrange frequency level of the Clean channel.

6: LOW: Use this control to adjust the low frequency level of the Clean channel.

7: VOL: Use this control to adjust the output level of the Clean channel.

8: CLEAN LED: This LED illuminates when the Clean channel is selected.

9: SOLO/RHYTHM/CLEAN SELECT: Use this switch to select the Clean channel or the Solo and Rhythm channels. With the switch in the out position, the Clean channel is selected. When the switch is depressed, either the Solo or Rhythm channel is selected, depending on the setting of the Solo/Rhythm Select switch (#16).

SOLO/RHYTHM CHANNELS: High gain channels designed to give you sounds with serious overdrive.

10: LEVEL: Use this control to adjust the output level of the Rhythm channel.

11: HIGH: Use this control to adjust the high frequency level of the Solo/Rhythm channel.

12: MID: Use this control to adjust the midrange frequency level of the Solo/Rhythm channel.

13: LOW: Use this control to adjust the low frequency level of the Solo/Rhythm channel.

14: GAIN: Use this control to adjust the amount of distortion produced by the Rhythm channel.

15: RHYTHM LED: This LED illuminates when the Rhythm channel is selected.

16: SOLO/RHYTHM SELECT: Use this switch to select the Solo or Rhythm channel. When this switch is depressed, the Solo channel is selected. With the switch in the out position, the Rhythm channel is selected. This switch is active only when the Solo/Rhythm/Clean Select switch (#9) is depressed.

17: LEVEL: Use this control to adjust the output level of the Solo channel.

18: SHAPE: Use this control to "dial in" the tone for the Solo channel. Rotating the control counterclockwise enhances the mid frequencies, while rotating the control clockwise enhances the low and high frequencies.

CRATE GT120HL Three-Channel Guitar Amplifier

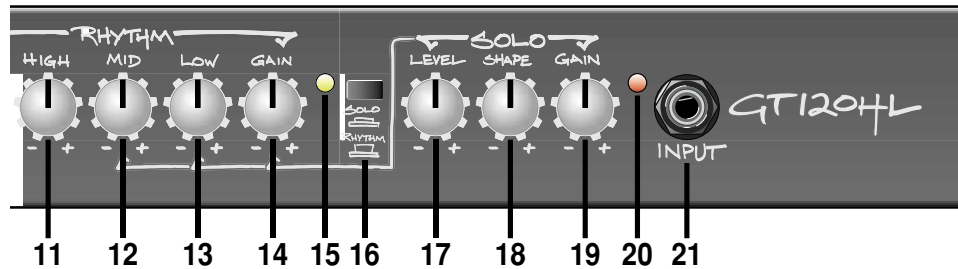

- 19: GAIN:** Use this control to adjust the amount of distortion produced by the Solo channel.
- 20: SOLO LED:** This LED illuminates when the Solo channel is selected.
- 21: INPUT:** Use this jack to connect your guitar to the amplifier by means of a shielded instrument cable.

The Rear Panel:

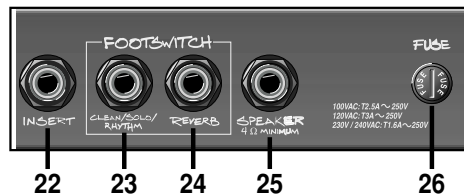

- 22: INSERT:** Use this jack to connect an external effects device to the amplifier. Use Crate's STP201, STP202, or STP203 stereo-to-mono Y-cord or an adapter such as Crate's YPP117 and two 1/4" mono signal cables to connect to the effect as shown below.
- 23: CLEAN/SOLO/RHYTHM FOOTSWITCH:** Use this jack to connect the 1/4" stereo plug on the footswitch cable to the three-button footswitch (supplied). This allows you to remotely switch between the Clean and Distortion channels and between the Solo and Rhythm channels.
- 24: REVERB FOOTSWITCH:** Use this jack to connect the 1/4" mono plug on the footswitch cable to the three-button footswitch (supplied). This allows you to remotely turn the reverb on and off.
- 25: SPEAKER:** Use this jack to connect the amplifier to your speaker cabinet(s). The minimum impedance for the cabinet(s) is 4 ohms.

WARNING: The speaker output of this unit can exceed 10 Watts and could be a shock injury. Connection to speakers should be performed by a skilled person in compliance with local building codes. Class 2 wiring is required for speaker cables. Use of external speakers outside the ratings stated at the speaker jack may result in a shock injury or damage to the unit.

26: FUSE: The fuse protects the amplifier from damages caused by a faulty AC power source and/or other problems. If the fuse opens, replace it ONLY with the same size and type. If fuses continue to fail, check the AC source – if the source is okay, contact your Crate dealer for service information.

27: AC LINE CORD (not shown): This grounded power cord is to be plugged into a grounded power outlet, wired to current electrical codes and compatible with the voltage, power, and frequency requirements stated on the rear panel. **Do not attempt to defeat the safety ground connection.**

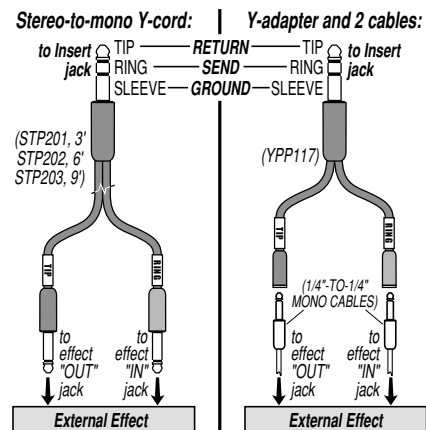

CRATE GT120HL Three-Channel Guitar Amplifier

Suggested Settings:

Sweet 'n Clean:

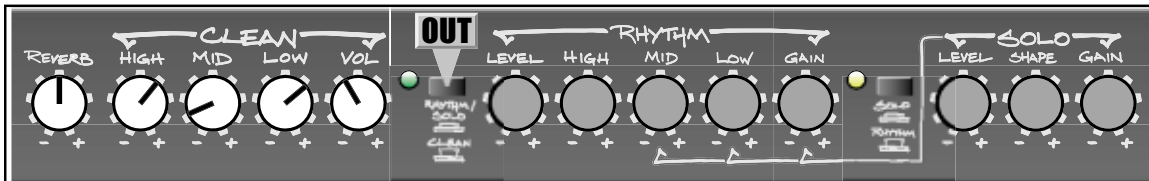

Just a 'Lil Nasty:

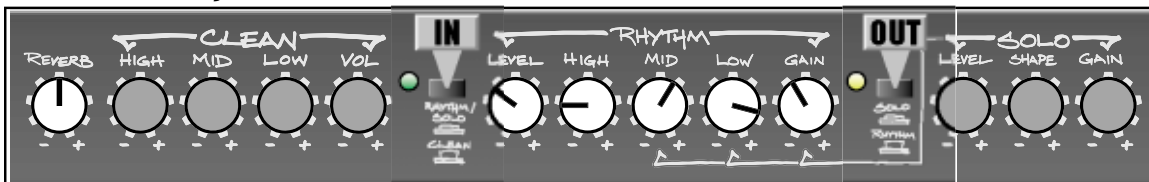

Politely Gritty:

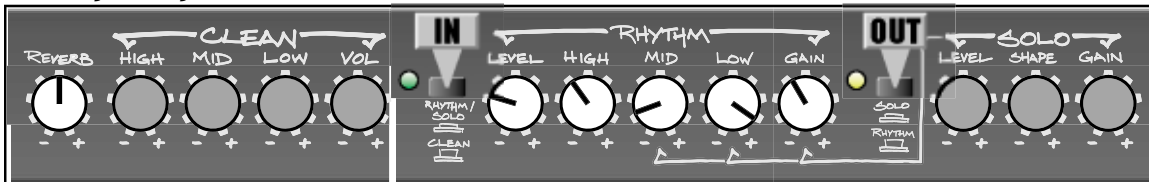

Down 'n Dirty:

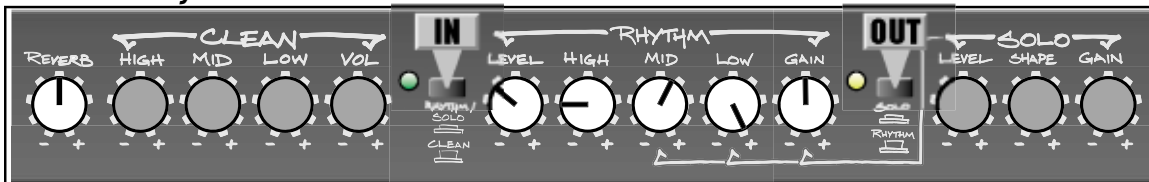

Mean & Obscene:

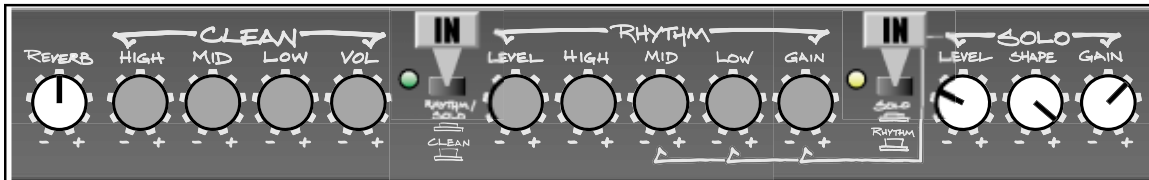

CRATE GT120HL Three-Channel Guitar Amplifier

System Block Diagram:

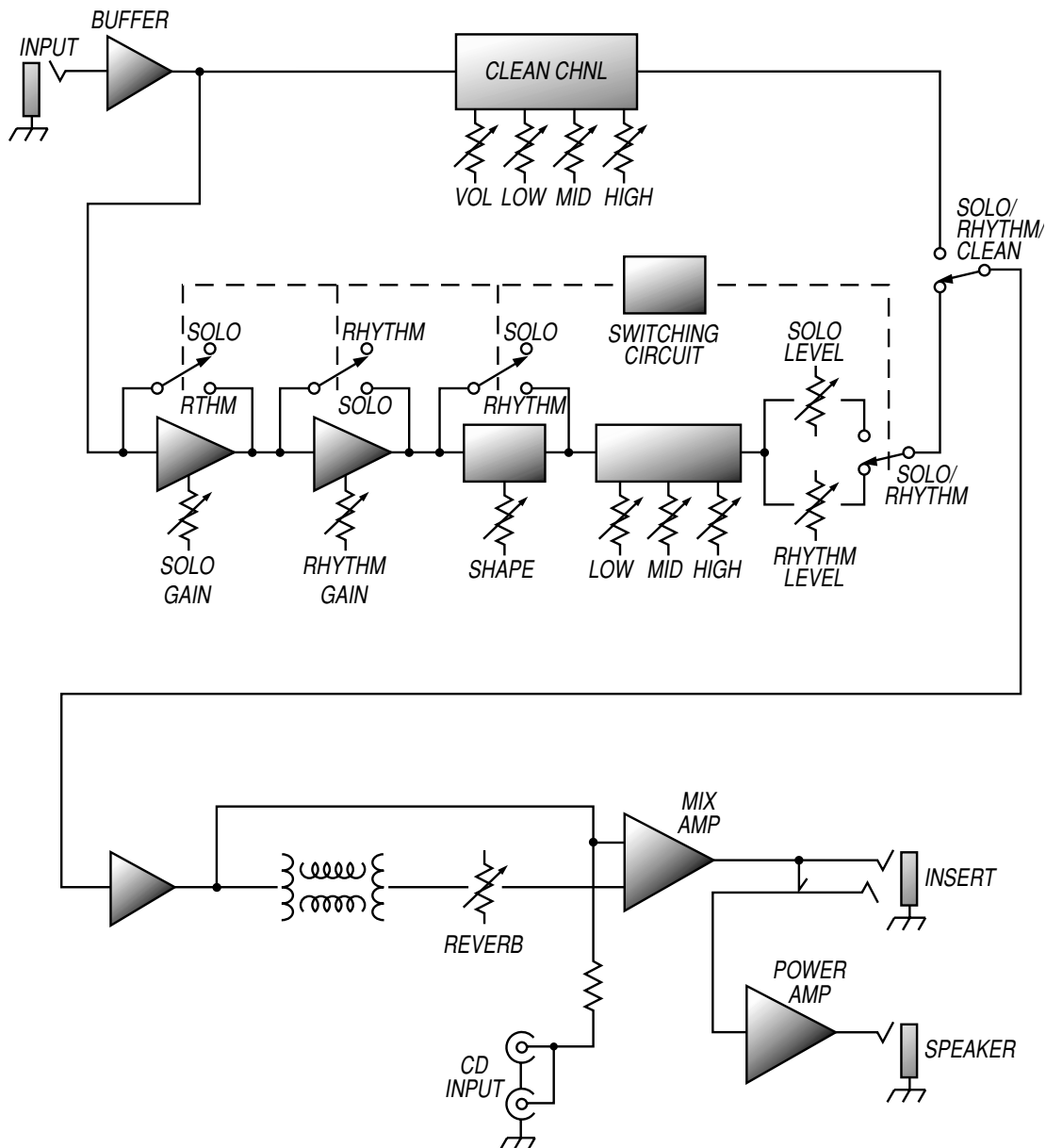

CRATE *GT120HL* Three-Channel Guitar Amplifier

GT120HL TECHNICAL SPECIFICATIONS:

Output Power Rating		120W RMS @5% THD, 4 Ω , 120 VAC
Input Impedance		470k Ω
Total System Gain	Solo Ch	110dB, all controls @10
	Overdrive Ch	88dB, all controls @10
	Clean Ch	58dB, all controls @10
CD Input		29dB
Maximum Input Signal Accepted		7 volts peak-to-peak
Solo Channel	Shape Control	Proprietary Circuit
O.D. Channel	Low Control	20dB range @ 80Hz
	Mid Control	15dB range @ 1kHz
	High Control	20dB range @ 10kHz
Clean Channel	Low Control	36dB range @ 80Hz
	Mid Control	15dB range @ 800Hz
	High Control	40dB range @ 10kHz
Power Requirements		120 VAC, 60Hz, 95VA 100/115VAC, 50/60Hz, 95VA; 230VAC, 50/60Hz, 95VA
Size and Weight		9.5" H x 26" W x 10" D, 25 lbs.

The GT120HL is covered with a durable Tolex material: wipe it clean with a lint-free cloth. Never spray cleaning agents onto the cabinet. Avoid abrasive cleansers which would damage the finish.

Crate continually develops new products, as well as improves existing ones. For this reason, the specifications and information in this manual are subject to change without notice.



www.crateamps.com



©2004 SLM Electronics, a division of St. Louis Music, Inc • 1400 Ferguson Avenue • St. Louis, MO 63133
47-368-01 • 111604

Free Manuals Download Website

<http://myh66.com>

<http://usermanuals.us>

<http://www.somanuals.com>

<http://www.4manuals.cc>

<http://www.manual-lib.com>

<http://www.404manual.com>

<http://www.luxmanual.com>

<http://aubethermostatmanual.com>

Golf course search by state

<http://golfingnear.com>

Email search by domain

<http://emailbydomain.com>

Auto manuals search

<http://auto.somanuals.com>

TV manuals search

<http://tv.somanuals.com>