

# ***CRATE***

## ***GX-212 GUITAR AMPLIFIER***







### ***OWNER'S MANUAL***



## TABLE OF CONTENTS:

Introduction	.3
The Front Panel	.4,5
Suggested Settings	.6
System Block Diagram	.7
Technical Specifications	.back cover

 <b>CAUTION</b> RISK OF ELECTRIC SHOCK DO NOT OPEN	 <b>PRECAUCION</b> RIESGO DE CORRIENTAZO NO ABRA	 <b>ATTENTION</b> RISQUE D'ELECTROCUTION NE PAS OUVRIR
<small>WARNING: TO REDUCE THE RISK OF FIRE OR ELECTRIC SHOCK, DO NOT EXPOSE THIS APPARATUS TO RAIN OR MOISTURE. TO REDUCE THE RISK OF ELECTRIC SHOCK, DO NOT REMOVE COVER. NO USER-SERVICEABLE PARTS INSIDE. REFER SERVICING TO QUALIFIED SERVICE PERSONNEL.</small>	<small>PRECAUCION: PARA REDUCIR EL RIESGO DE INCENDIOS O DESCARGAS ELECTRICAS, NO PERMITA QUE ESTE APARATO QUEDE EXPUESTO A LA LLUVIA O LA HUMEDAD. PARA DISMINUIR EL RIESGO DE CORRIENTAZO, NO ABRA LA CUBIERTA. NO HAY PIEZAS ADENTRO QUE EL USUARIO PUEDE REPARAR DE JE TODO MANTENIMIENTO A LOS TECNICOS CALIFICADOS.</small>	<small>ATTENTION: PROTEGEZ CET APPAREIL DE LA PLUIE ET DE L'HUMIDITE AFIN D'EVITER TOUT RISQUE D'INCENDIE OU D'ELECTROCUTION. POUR REDUIRE D'ELECTROCUTION NE PAS ENLEVER LE COUVERCLE. AUCUNE PIECE INTERNE N'EST REPRABLE PAR L'UTILISATEUR. POUR TOUTE REPARATION, S'ADRESSER A UN TECHNICIEN QUALIFIE.</small>
<h3>IMPORTANT SAFETY INSTRUCTIONS</h3>		
<ul style="list-style-type: none"> <li>• READ, FOLLOW, HEED, AND KEEP ALL INSTRUCTIONS AND WARNINGS.</li> <li>• DO NOT OPERATE NEAR ANY HEAT SOURCE AND DO NOT BLOCK ANY VENTILATION OPENINGS ON THIS APPARATUS. FOR PROPER OPERATION, THIS UNIT REQUIRES 3" (75mm) OF WELL VENTILATED SPACE AROUND HEATSINKS AND OTHER AIR FLOW PROVISIONS IN THE CABINET.</li> <li>• DO NOT USE THIS APPARATUS NEAR SPLASHING, FALLING, SPRAYING, OR STANDING LIQUIDS.</li> <li>• CLEAN ONLY WITH LINT-FREE DAMP CLOTH AND DO NOT USE CLEANING AGENTS.</li> <li>• ONLY CONNECT POWER CORD TO A POLARIZED, SAFETY GROUNDED OUTLET WIRED TO CURRENT ELECTRICAL CODES AND COMPATIBLE WITH VOLTAGE, POWER, AND FREQUENCY REQUIREMENTS STATED ON THE REAR PANEL OF THE APPARATUS.</li> <li>• PROTECT THE POWER CORD FROM DAMAGE DUE TO BEING WALKED ON, PINCHED, OR STRAINED.</li> <li>• UNPLUG THE APPARATUS DURING LIGHTNING STORMS OR WHEN UNUSED FOR LONG PERIODS OF TIME.</li> <li>• ONLY USE ATTACHMENTS, ACCESSORIES, STANDS, OR BRACKETS SPECIFIED BY THE MANUFACTURER FOR SAFE OPERATION AND TO AVOID INJURY.</li> <li>• THIS APPARATUS DOES NOT OPERATE NORMALLY AND REQUIRES SERVICE WITH ANY PHYSICAL DAMAGE FROM IMPACT OR ANY EXPOSURE TO MOISTURE.</li> <li>• SERVICE MUST BE PERFORMED BY QUALIFIED PERSONNEL.</li> <li>• OUR AMPLIFIERS ARE CAPABLE OF PRODUCING HIGH SOUND PRESSURE LEVELS. CONTINUED EXPOSURE TO HIGH SOUND PRESSURE LEVELS CAN CAUSE PERMANENT HEARING IMPAIRMENT OR LOSS. USER CAUTION IS ADVISED AND EAR PROTECTION IS RECOMMENDED IF UNIT IS OPERATED AT HIGH VOLUME.</li> </ul>		
<small>EXPLANATION OF GRAPHICAL SYMBOLS:          EXPLICACION DE SIMBOLOS GRAFICOS:          EXPLICATION DES SYMBOLES GRAPHIQUES:</small>	 = "DANGEROUS VOLTAGE" "VOLTAJE PELIGROSO" "DANGER HAUTE TENSION"	 = "IT IS NECESSARY FOR THE USER TO REFER TO THE INSTRUCTION MANUAL" "ES NECESARIO QUE EL USUARIO SE REFIERA AL MANUAL DE INSTRUCCIONES." "REFERREZ-VOUS AU MANUAL D'UTILISATION"



**Congratulations!**

You are now the proud owner of the Crate GX-212 guitar amplifier. These rugged amplifiers deliver serious clean and distorted sounds through two premium 12" Crate Custom speakers. Channel selection, Crate's exclusive Shape circuit, and DSP on/off are controllable by the supplied three-button footswitch. An insert jack allows virtually noise-free connection of your favorite effects.

Like all Crate products, your GX-212 is designed by musicians, and built using only the best components. Extensive testing ensures you that this amplifier is the absolute best it can be.

In order to get the most out of your new amplifier, we strongly urge you to go over the information contained in this manual before you begin playing.

And **thank you** for choosing **CRATE**<sup>®</sup>



**1: INPUT:** Connect your guitar here by means of a shielded instrument cable.

**OVERDRIVE CHANNEL:** A high gain channel giving you sounds from a slight edge to serious overdrive.

**2: GAIN 1:** Gain 1 is active only when the Gain Select switch (#5) is out. When active, this control adjusts the amount of compression and distortion from the amplifier. At far left, the sound will have a thick compressed quality. As you turn the control to the right the amount of distortion increases. Gain 1 produces less intense distortion than Gain 2.

**3: GAIN 2:** Gain 2 is active only when the Gain Select switch (#5) is depressed. When active, this control adjusts the amount of compression and distortion from the amplifier. At far left, the sound will have a thick compressed quality. As you turn the control to the right the amount of distortion increases. Gain 2 produces more intense distortion than Gain 1.

**4: SHAPE:** Working in conjunction with the Gain 2 control, rotate the Shape control until you find the sound you're looking for. Rotating the control counter-clockwise enhances the mid frequencies; rotating it clockwise enhances the low and high frequencies. (This control is only effective when Gain 2 is selected.)

**5: GAIN SELECT:** Use this switch to select Gain 1 (switch out) or Gain 2 (switch depressed). A footswitch (#21) overrides this switch.

**6: LOW:** Use this control to adjust the low frequency output level of the Overdrive channel. This control provides a range of 11dB at 80Hz.

**7: HIGH:** Use this control to adjust the high frequency output level of the Overdrive channel. This control provides a range of 10dB at 10kHz.

**8: LEVEL:** Use this control to adjust the output level of the Overdrive Channel. Use this control along with the Gain and Shape controls (#2, 3 & 4) to create a wide variety of sounds.

**9: CHANNEL SELECT:** Use this switch to select the Clean channel (switch out) or the Overdrive channel (switch depressed). One of the triangular LEDs beside the switch will illuminate to indicate which channel is selected. A footswitch (#21) overrides this switch.

**CLEAN CHANNEL:** A normal gain channel designed to give you crystal clear sounds.

**10: LEVEL:** Use this control to adjust the output level of the Clean Channel.

**11: LOW:** Use this control to adjust the low frequency output level of the Clean channel. This control provides a range of 22dB at 80Hz.

**12: MID:** Use this control to adjust the mid frequency output level of the Clean channel. This control provides a range of 14dB at 600Hz.

**13: HIGH:** Use this control to adjust the high frequency output level of the Clean channel. This control provides a range of 28dB at 10kHz.

**14: REVERB LEVEL:** Use this control to adjust the amount of reverberation. In the full counter-clockwise position the output signal is "dry" (no reverb); rotating the control clockwise increases the amount of reverb. The reverb can be turned on and off by means of a footswitch (see #22).

**15: INSERT:** Use this jack to connect an external effects device to the amplifier. Use a stereo 1/4" male Y-cord: ring = send, tip = return, sleeve = ground. See the illustration on the panel to the right for more information.

# CRATE<sup>®</sup> GX-212 Amplifier

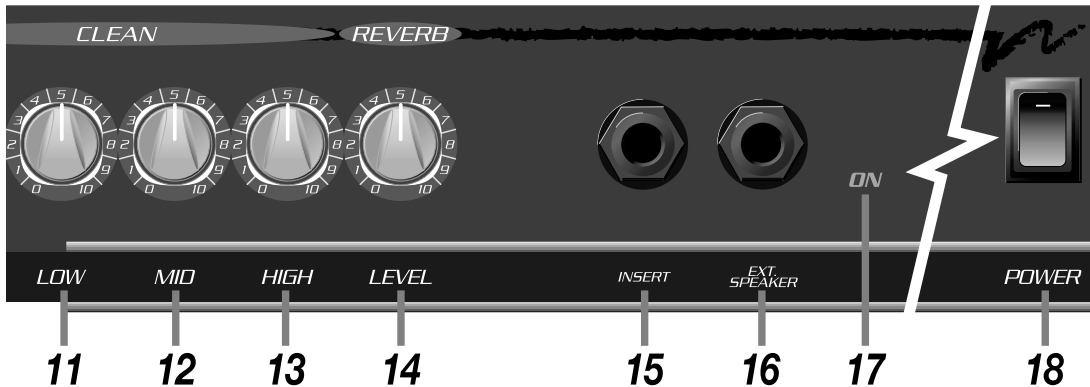

**16: EXT. SPEAKER:** Use this jack to connect an extension speaker cabinet to the amplifier. This jack is wired in series with the internal speaker(s).

**WARNING:** Do not attempt to use headphones in the Speaker jack! Permanent hearing damage could result!

**17: POWER ON LED:** This LED illuminates when the amplifier is turned on.

**18: POWER SWITCH:** Use this switch to turn the amplifier on (top of the switch depressed) and off (bottom of the switch depressed).

**19. POWER CORD (rear panel, not shown):** The grounded power cord should only be plugged into a grounded power outlet that meets all applicable electrical codes and is compatible with the voltage, power, and frequency requirements stated on the rear panel. **Do not attempt to defeat the safety ground connection.**

**20: FUSE (rear panel, not shown):** This protects the amplifier against damages caused from a faulty AC power source or other problems. If the fuse blows, replace it **ONLY** with the same size and type fuse. If the fuse blows repeatedly check the AC source; if it's okay, contact your Crate dealer for service information.

**21: CHANNEL SELECT / GAIN FOOTSWITCH JACK (rear panel, not shown):** Use this jack to connect the 1/4" stereo plug on the footswitch cable to the three-button footswitch (supplied). This allows you to remotely switch between the Clean and Overdrive channels and between Gain 1 and 2 of the Overdrive channel.

**22: REVERB FOOTSWITCH JACK (rear panel, not shown):** Use this jack to connect the 1/4" mono plug on the footswitch cable to the three-button footswitch (supplied). This allows you to remotely turn the reverb on and off.

### Connecting to the Insert jack:

The Insert jack (#15) lets you patch external effects into the amplifier just prior to its power amp stage. Use Crate's STP201, STP202 or STP203 stereo-to-mono Y-cord or an adapter such as Crate's YPP117 and 2 1/4" mono signal cables to connect to the effect as shown in the illustration below.

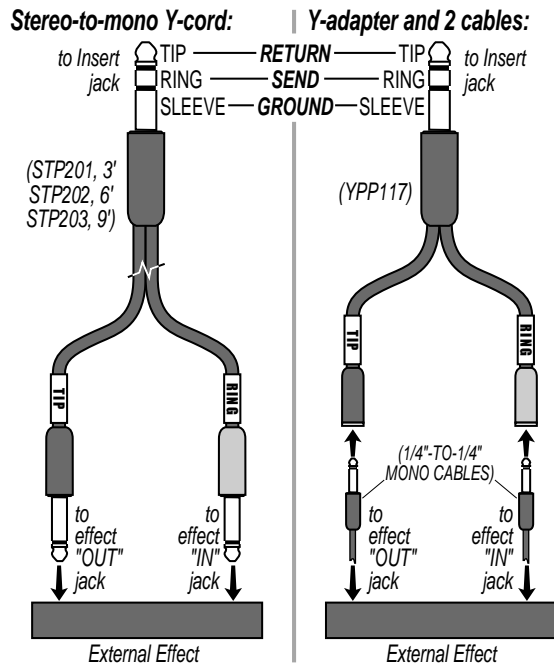



## SUGGESTED STARTING SETTINGS:

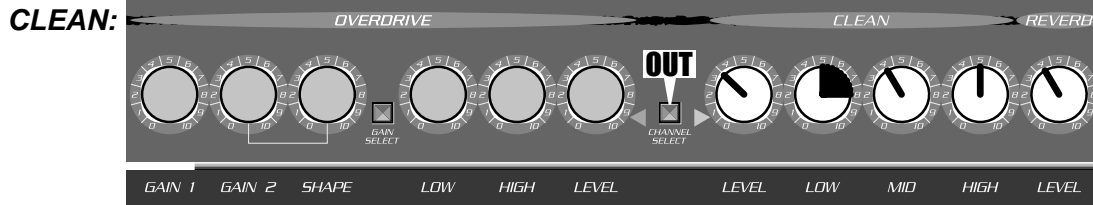

**SYSTEM BLOCK DIAGRAM:**

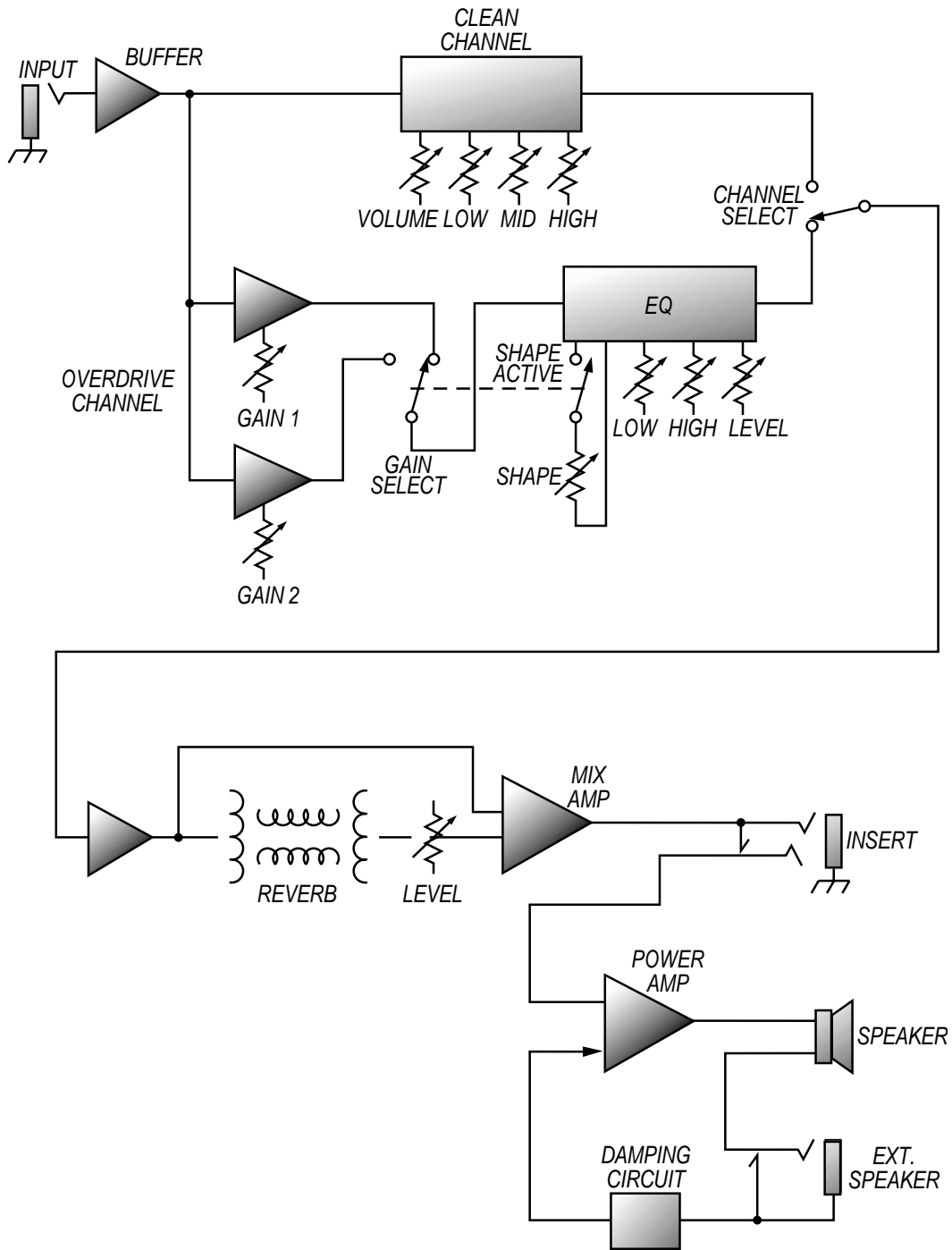

# **CRATE**<sup>®</sup> GX-212 Amplifier

## **GX-212 TECHNICAL SPECIFICATIONS**

Output Power Rating	115 watts RMS @ 5% THD 4 ohms load 120VAC
Speaker Size and Rating	(2) Crate Custom 12", 8 ohms
Input Impedance	470k ohms
Maximum Input Signal Level Accepted	7 volts, peak-to-peak
Total System Gain	Overdrive Channel: 110dB all controls @10, Gain 2; 88dB Gain 1 Clean Channel: 58dB all controls @10
Overdrive Channel:	Low Control: 11dB Range @ 80Hz Shape Control: Proprietary Circuit High Control: 10dB Range @ 10kHz
Clean Channel:	Low Control: 22dB Range @ 80Hz Mid Control: 14dB Range @ 600Hz High Control: 28dB Range @ 10kHz
Input Power Requirements	120 VAC, 60Hz, 95VA 100/115VAC, 50/60Hz, 95VA 230VAC, 50/60Hz, 95VA
Cabinet Size and Weight:	21" H x 26-1/2" W x 11" D, 50 lbs.

The GX-212 is covered with a durable black Tolex material: wipe it clean with a lint-free cloth. Never spray cleaning agents onto the cabinet. Avoid abrasive cleansers which could damage the finish.

### **Declaration Of Conformity**

#30, Effective 01-01-2001

**Manufacturer's Name:** SLM Electronics  
**Production Facility:** 11880 Borman Drive, St. Louis, MO 63146, USA  
**Production Facility:** 700 Hwy 202 W, Yellville, AR 72687, USA  
**Shipping Facility:** 1400 Ferguson Ave., St. Louis, MO 63133, USA  
**Office Facility:** 1400 Ferguson Ave., St. Louis, MO 63133, USA

**Product Type:** Audio Amplifier

**Complies with Standards:**

**LVD:** 92/31/EEC, 93/68/EEC, & 73/23/EWG  
**Safety:** EN60065  
**EMC:** EN55013, EN55020, EN55022, EN61000-3-2,  
& EN61000-3-3

Supplementary information provided by:  
SLM Electronics - R & D Engineering  
1901 Congressional Drive, St Louis, MO 63146, USA  
Tel.: 314-569-0141, Fax: 314-569-0175

*Crate continually develops new products, as well as improves existing ones. For this reason, the specifications and information in this Crate manual are subject to change without notice.*

# **CRATE**<sup>®</sup>

[www.crateamps.com](http://www.crateamps.com)



©2001 SLM ELECTRONICS, A DIVISION OF ST. LOUIS MUSIC, 1400 FERGUSON, ST. LOUIS, MO. U.S.A. 63133  
P/N 18-160-03 • 05/02



## Free Manuals Download Website

<http://myh66.com>

<http://usermanuals.us>

<http://www.somanuals.com>

<http://www.4manuals.cc>

<http://www.manual-lib.com>

<http://www.404manual.com>

<http://www.luxmanual.com>

<http://aubethermostatmanual.com>

Golf course search by state

<http://golfingnear.com>

Email search by domain

<http://emailbydomain.com>

Auto manuals search

<http://auto.somanuals.com>

TV manuals search

<http://tv.somanuals.com>