

# **CRATE**

## *KX-15 KEYBOARD AMPLIFIER*



**OWNER'S MANUAL**  
**MANUAL DEL PROPIETARIO**  
**Mode d'Emploi**



## **Congratulations!**

You are now the proud owner of the Crate KX-15 keyboard amplifier. This compact powerhouse offers warm clean tones and great, easy-to-use equalization. Each of the two input jacks has its own volume control so you can mix your keyboard with another instrument, a tape deck or a Hi-Z vocal mic. The Headphone jack allows for private practicing and the external speaker jack allows you to connect the amp to another speaker cabinet.





Like all Crate products, your KX-15 is designed by musicians, and built using only the best components. Extensive testing at the hands (and ears) of skilled technicians and musicians insures you that this amplifier is the absolute best it can be.

In order to get the most out of your new amplifier, we strongly urge you to go over the information contained in this manual before you begin playing.

And ***thank you*** for choosing **CRATE<sup>®</sup>**

## **TABLE OF CONTENTS:**

The Front Panel - English	.....	.3
The Front Panel - Spanish	.....	.4
The Front Panel - French	.....	.5
System Block Diagram	.....	.6
Technical Specifications	.....	.back cover

 <b>CAUTION</b> RISK OF ELECTRIC SHOCK DO NOT OPEN	 <b>PRECAUCION</b> RIESGO DE CORRIENTAZO NO ABRA	 <b>ATTENTION</b> RISQUE D'ELECTROCUTION NE PAS OUVRIR
WARNING: TO REDUCE THE RISK OF FIRE OR ELECTRIC SHOCK, DO NOT EXPOSE THIS APPARATUS TO RAIN OR MOISTURE. TO REDUCE THE RISK OF ELECTRIC SHOCK, DO NOT REMOVE COVER. NO USER-SERVICEABLE PARTS INSIDE. REFER SERVICING TO QUALIFIED SERVICE PERSONNEL.	PRECAUCION: PARA REDUCIR EL RIESGO DE INCENDIOS O DESCARGAS ELECTRICAS, NO PERMITA QUE ESTE APARATO QUEDE EXPUESTO A LA LLUVIA O LA HUMEDAD. PARA DISMINUIR EL RIESGO DE CORRIENTAZO, NO ABRA LA CUBIERTA. NO HAY PIEZAS ADENTRO QUE EL USUARIO PUEDE REPARAR DE JE TODO MANTENIMIENTO A LOS TECNICOS CALIFICADOS.	ATTENTION: PROTEGEZ CET APPAREIL DE LA PLUIE ET DE L'HUMIDITE AFIN D'EVITER TOUT RISQUE D'INCENDIE OU D'ELECTROCUTION. POUR REDUIRE D'ELECTROCUTION NE PAS ENLEVER LE COUVERCLE. AUCUNE PIECE INTERNE N'EST REPRABLE PAR L'UTILISATEUR. POUR TOUTE REPARATION, S'ADRESSER A UN TECHNICIEN QUALIFIE.
<b>IMPORTANT SAFETY INSTRUCTIONS</b>		
<ul style="list-style-type: none"> <li>• READ, FOLLOW, HEED, AND KEEP ALL INSTRUCTIONS AND WARNINGS.</li> <li>• DO NOT OPERATE NEAR ANY HEAT SOURCE AND DO NOT BLOCK ANY VENTILATION OPENINGS ON THIS APPARATUS. FOR PROPER OPERATION, THIS UNIT REQUIRES 3" (75mm) OF WELL VENTILATED SPACE AROUND HEATSINKS AND OTHER AIR FLOW PROVISIONS IN THE CABINET.</li> <li>• DO NOT USE THIS APPARATUS NEAR SPLASHING, FALLING, SPRAYING, OR STANDING LIQUIDS.</li> <li>• CLEAN ONLY WITH LINT-FREE DAMP CLOTH AND DO NOT USE CLEANING AGENTS.</li> <li>• ONLY CONNECT POWER CORD TO A POLARIZED, SAFETY GROUNDED OUTLET WIRED TO CURRENT ELECTRICAL CODES AND COMPATIBLE WITH VOLTAGE, POWER, AND FREQUENCY REQUIREMENTS STATED ON THE REAR PANEL OF THE APPARATUS.</li> <li>• PROTECT THE POWER CORD FROM DAMAGE DUE TO BEING WALKED ON, PINCHED, OR STRAINED.</li> <li>• UNPLUG THE APPARATUS DURING LIGHTNING STORMS OR WHEN UNUSED FOR LONG PERIODS OF TIME.</li> <li>• ONLY USE ATTACHMENTS, ACCESSORIES, STANDS, OR BRACKETS SPECIFIED BY THE MANUFACTURER FOR SAFE OPERATION AND TO AVOID INJURY.</li> <li>• THIS APPARATUS DOES NOT OPERATE NORMALLY AND REQUIRES SERVICE WITH ANY PHYSICAL DAMAGE FROM IMPACT OR ANY EXPOSURE TO MOISTURE.</li> <li>• SERVICE MUST BE PERFORMED BY QUALIFIED PERSONNEL.</li> <li>• OUR AMPLIFIERS ARE CAPABLE OF PRODUCING HIGH SOUND PRESSURE LEVELS. CONTINUED EXPOSURE TO HIGH SOUND PRESSURE LEVELS CAN CAUSE PERMANENT HEARING IMPAIRMENT OR LOSS. USER CAUTION IS ADVISED AND EAR PROTECTION IS RECOMMENDED IF UNIT IS OPERATED AT HIGH VOLUME.</li> </ul>		
EXPLANATION OF GRAPHICAL SYMBOLS: EXPLICACION DE SIMBOLOS GRAFICOS: EXPLICATION DES SYMBOLES GRAPHIQUES:	 = "DANGEROUS VOLTAGE" "VOLTAJE PELIGROSO" "DANGER HAUTE TENSION"	 = "IT IS NECESSARY FOR THE USER TO REFER TO THE INSTRUCTION MANUAL" "ES NECESARIO QUE EL USUARIO SE REFIERA AL MANUAL DE INSTRUCCIONES." "REFERREZ-VOUS AU MANUAL D'UTILISATION"

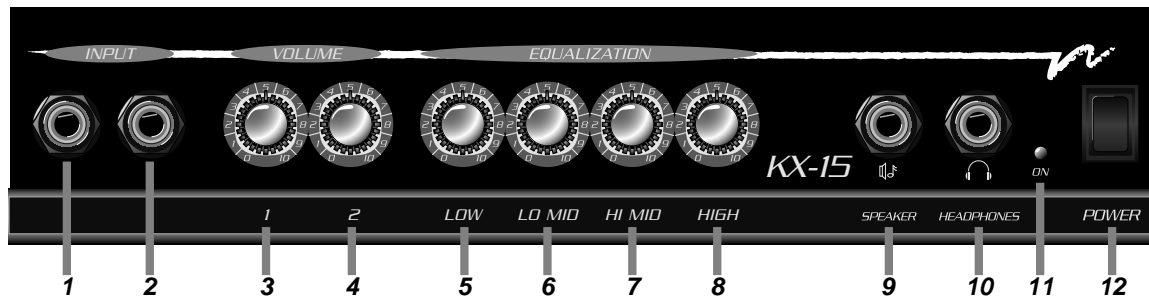

### FRONT PANEL:

**1: INPUT 1:** Use this 1/4" jack to connect your keyboard or other line level signal to the amplifier by means of a shielded instrument cable. The level at this jack is controlled by the Volume 1 knob (#3).

**2: INPUT 2:** Use this 1/4" jack to connect your keyboard or other line level signal to the amplifier by means of a shielded instrument cable. The level at this jack is controlled by the Volume 2 knob (#4).

**3: VOLUME 1:** Use this control to adjust the level of the signal connected to the Input 1 jack (#1).

**4: VOLUME 2:** Use this control to adjust the level of the signal connected to the Input 2 jack (#2).

**5: LOW:** Use this control to adjust the bass response of the amplifier. Rotating the control counterclockwise reduces the low frequency output. Rotating the control clockwise increases the low frequency output. It may be necessary to reduce the Low frequency output at higher volume levels.

**6: LOW MID:** Use this control to adjust the "thickness" or "fatness" of the amplifier. Rotating the control counterclockwise reduces the lower midrange frequency output. Rotating the control clockwise increases the lower midrange frequency output.

**7: HIGH MID:** Use this control to adjust the clarity and definition of the amplifier. Rotating the control counterclockwise reduces the upper midrange frequency output. Rotating the control clockwise increases the upper midrange frequency output.

**8: HIGH:** Use this control to adjust the high frequency response of the amplifier. Rotating the control counterclockwise reduces the high frequency output. Rotating the control clockwise increases the high frequency output.

**9: EXTERNAL SPEAKER:** Use this jack to connect the amplifier to an external speaker. The internal speaker is disconnected when this jack is used. The impedance of the external speaker must be 4 ohms or greater.

**WARNING:** Do not attempt to use headphones in the Speaker jack! Permanent hearing damage could result!

**10: HEADPHONES:** Use this jack to connect headphones to the amplifier. The internal speaker is disconnected when this jack is used. A line level signal can also be obtained from this jack for recording, etc.

**CAUTION:** To avoid possible damage to your hearing, so not use headphones for extended periods of time at extremely loud levels.

**11: ON LED:** This LED illuminates when the amplifier is turned on.

**12: POWER:** Use this switch to turn the amplifier on (top of the switch depressed) and off (bottom of the switch depressed).

**13: POWER CORD (rear panel, not shown):** The grounded power cord should only be plugged into a grounded power outlet that meets all applicable electrical codes and is compatible with the voltage, power, and frequency requirements stated on the rear panel. **Do not attempt to defeat the safety ground connection.**

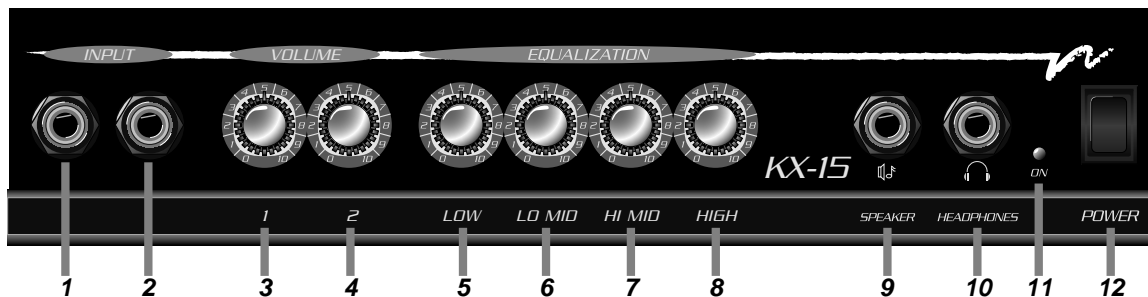

### SECCION DE ENTRADA:

- 1: ENTRADA 1** acepta una clavija para teléfono estándar de 1/4" y se controla por medio de la perilla para Volumen 1 (#3).
- 2: ENTRADA 2** acepta una clavija para teléfono estándar de 1/4" y se controla por medio de la perilla para Volumen 2 (#4).
- 3: VOLUMEN 1** establece el nivel del volumen a la salida de la Entrada 1. Conforme usted aumente el volumen, retroceda el control de Bajos (#5).
- 4: VOLUMEN 2** establece el nivel del volumen a la salida de la Entrada 2. Conforme usted aumente el volumen, retroceda el control de Bajos (#5).

### SECCION DE ECUALIZACION:

- 5: BAJOS** ajuste el nivel de la salida de frecuencias bajas. Debido a la cantidad masiva de partes bajas disponibles, usted tal vez quiera retroceder los bajos a volúmenes altos.
- 6: MEDIANOS BAJOS** tiende a impartirle una característica más "gruesa" ó "llena" al sonido..
- 7: MEDIANOS ALTOS** determina el que su sonido resulte "áspero y penetrante" ó "distante y amortiguado".
- 8: AGUDOS** controla el rango superior de frecuencias y añade brillantez (al sonido).

- 9: BOCINA EXTERNA** es para conectar el KX-15 a una bocina externa.

**¡ADVERTENCIA!** ¡No use los audífonos en el enchufe hembra de altavoz alargador! El resultado puede ser daño permanente al oído.

- 10: AUDIFONOS** se permite sesiones de práctica en privado. La bocina interna queda desconectada cuando se estén usando los audífonos.
- 11: DIODO (LED) DE PRENDIDO** brillará la palabra "ON" cuando usted encienda el KX-15.

- 12: ENERGIA** es para prender y apagarlo el amplificador.

### PANEL POSTERIOR

- 13: CABLE DE ENERGIA:** Este cordón de potencia, con tres conductores, para servicio pesado, y conectado a tierra, se debe conectar SOLO a un receptáculo de CA de 120 volts, 60 ciclos, que esté seguramente cableado y conectado a tierra. (Si su KX-15 fué adquirido fuera de los Estados Unidos, vea el panel posterior de la unidad para conocer su potencia de diseño y siga las pautas arriba señaladas.) ¡NO INTENTE pasar por alto la conexión a tierra de este cable!

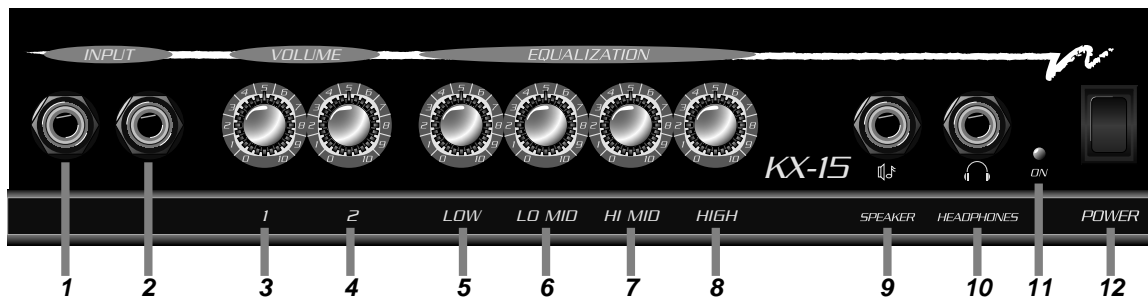

### SECTION DU SIGNAL D'ENTREE:

- 1: PRISE POUR INSTRUMENT 1** accepte une fiche de 1/4" (6,35mm) et est gouverné par le Volume 1 bouton de réglage.
- 2: PRISE POUR INSTRUMENT 2** accepte une fiche de 1/4" (6,35mm) et est gouverné par le Volume 2 bouton de réglage.
- 3: VOLUME 1** règle le niveau de son total pour Entrée 1. (Réduire a hauts volumes qui vous pouvez vouloir le niveau de la bouton de réglage Basse, #5.)
- 4: VOLUME 2** règle le niveau de son total pour Entrée 2. (Réduire a hauts volumes qui vous pouvez vouloir le niveau de la bouton de réglage Basse, #5.)

### ÉGALISATION ET SORTIE

- 5: BAS** determine le niveau des sons graves de l'amplificateur. (Réduire a hauts volumes qui vous pouvez vouloir le niveau de celui-ci bouton.)
- 6: BAS-MOYEN** tend à ajouter une caractéristique plus «épais» ou plus «plat» au son.
- 7: HAUT-MOYEN** determine si le son est «dur et perçant» ou «éloigné et doux.»
- 8: HAUT** determine le niveau des hautes fréquences et adjoute la clarté.
- 9: ENCEINTE SUPPLÉMENTAIRE** est pour connecter le KX-15 à un haut-parleur supplémentaire.

**AVERTISSEMENT!** Ne pas utiliser un casque d'écoute dans la prise pour un haut-parleur auxiliaire. La surdité peut résulter.

- 10: PRISE CASQUE** pour avoir la pratique privée, brancher une fiche de casque d'écoute sur cette prise. Le haut-parleur se déconnecte automatiquement quand le casque est branché.
- 11: VOYANT LUMINEUX «ON»** est illuminé quand l'appareil marche.
- 12: COMMANDE MARCHE-ARRÊTE** contrôle le pouvoir CA.

### FACE DERRIERE

- 13: CORDON DE POUVOIR:** Le KX-15 est équipé avec un cordon de grande puissance avec trois fils à la masse. Etre certain que ce cordon se branche correctement sur une prise de courant de 120 volt, 60 Hz CA sauvement à la masse avant l'utilisation. (Si le KX-15 a été acheté au dehors des Etats-Unis, voir la face derrière pour le régime de puissance de cet appareil). Pour votre protection, ne pas essayer à vaincre la contact de terre du cordon.

## SYSTEM BLOCK DIAGRAM:

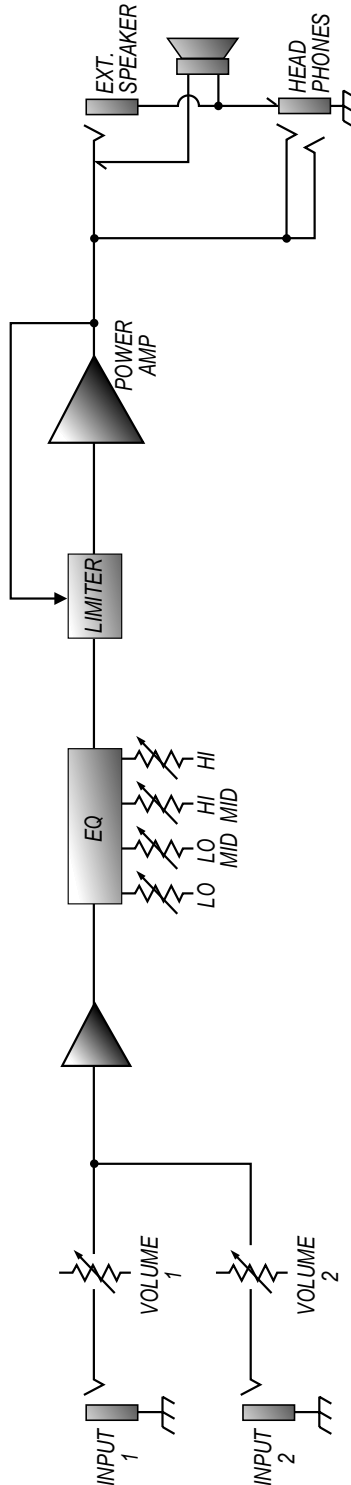



*Use this blank page for notes, etc...*

# **CRATE**<sup>®</sup> KX-15 Keyboard Amplifier

## **KX-15 TECHNICAL SPECIFICATIONS:**

Maximum Input Signal Level Accepted	15 volts peak to peak
Input Impedance	35k ohms
Total System Gain	46dB @ 1kHz
Signal To Noise Ratio	72dB
Output Power Rating	12+ watts RMS @ 5% THD, 4 ohm load – 120 VAC line
Low Control	15dB Range @ 60Hz
Low Mid Control	18dB Range @ 630Hz
High Mid Control	19dB Range @ 2kHz
High Control	27dB Range @ 10kHz
Input Power Requirements	120 VAC, 60Hz, 30VA 100/110 VAC, 50/60Hz, 30VA 230 VAC, 50/60Hz, 30VA
Speaker Size and Rating	Crate Custom Design 8", 15 watts
Cabinet Size and Weight	13.25" H x 13.125" W x 9" D, 18.5 lbs.

The KX-15 is covered with a durable black Tolex material: wipe it clean with a lint-free cloth. Never spray cleaning agents onto the cabinet. Avoid abrasive cleansers which would damage the finish.

*El KX-15 esta cubierto con un material durable Tolex: limpielo con una toalla seca. Nunca rocíe el gabinete con sustancias limpiadoras. Evite usar materiales abrasivos con los cuales pueda danar el acabado.*

*Le KX-15 est couvert avec «Tolex» un revêtement noir et durable. Essayez cette matière avec une toile propre et sans charpie. Ne pulvérisez jamais les agents de nettoyage sur l'appareil. Évitez les nettoyeurs abrasifs qui peuvent endommager le «Tolex.»*

### **Declaration Of Conformity**

#27, Effective 01-01-2001

<b>Manufacturer's Name:</b>	SLM Electronics
<b>Production Facility:</b>	11880 Borman Drive, St. Louis, MO 63146, USA
<b>Production Facility:</b>	700 Hwy 202 W, Yellville, AR 72687, USA
<b>Shipping Facility:</b>	1400 Ferguson Ave., St. Louis, MO 63133, USA
<b>Office Facility:</b>	1400 Ferguson Ave., St. Louis, MO 63133, USA
<b>Product Type:</b>	Audio Amplifier
<b>Complies with Standards:</b>	
<b>LVD:</b>	92/31/EEC, 93/68/EEC, & 73/23/EWG
<b>Safety:</b>	EN60065
<b>EMC:</b>	EN55013, EN55020, EN55022, EN61000-3-2, & EN61000-3-3

Supplementary information provided by:  
SLM Electronics - R & D Engineering  
1901 Congressional Drive, St Louis, MO 63146, USA  
Tel.: 314-569-0141, Fax: 314-569-0175

*Crate continually develops new products, as well as improves existing ones. For this reason, the specifications and information in this Crate manual are subject to change without notice.*

*Crate continuamente desarrolla nuevos productos, así como también mejora los existentes. Por esta razón, las especificaciones e información incluidos en este manual están sujetos a cambios sin previo aviso*

*Crate développe continuellement des nouveaux produits, ainsi d'améliorer ceux qui existe. Pour cette raison les spécifications et les informations dans ce manuel peuvent se changer sans préavis.*

# **CRATE**<sup>®</sup>

[www.crateamps.com](http://www.crateamps.com)



©2002 SLM ELECTRONICS, A DIVISION OF ST. LOUIS MUSIC, 1400 FERGUSON, ST. LOUIS, MO. U.S.A. 63133  
P/N 47-446-03 • 05/02



## Free Manuals Download Website

<http://myh66.com>

<http://usermanuals.us>

<http://www.somanuals.com>

<http://www.4manuals.cc>

<http://www.manual-lib.com>

<http://www.404manual.com>

<http://www.luxmanual.com>

<http://aubethermostatmanual.com>

Golf course search by state

<http://golfingnear.com>

Email search by domain

<http://emailbydomain.com>

Auto manuals search

<http://auto.somanuals.com>

TV manuals search

<http://tv.somanuals.com>