

*Owner's Guide*

*for the*

# **CRATE MX15R**

*Guitar Amplifier*



# MX15R Guitar Amplifier

## Congratulations!

You are now the proud owner of the compact but powerful Crate MX15R amplifier. Two versatile channels – one crystal clear and the other with our patented “Flex-Wave” distortion – combined with reverb and a three-band EQ offer you more flexibility and performance than any amp in its class. Our “Flex Wave” circuitry uses sequential cascading gains to deliver distortion which is rich in harmonics and is touch sensitive. A special damping circuit simulates the “current source” type of output of a tube amp, giving you solid state reliability combined with classic tube sounds.





Like all Crate products, your MX15R is designed by musicians, and built using only the best components. Extensive testing confirms that this amplifier is the absolute best it can be.

In order to get the most out of your new amplifier, we strongly urge you to read the information contained in this manual before you begin playing.

And **thank you** for choosing 

## TABLE OF CONTENTS:

Important Safeguards and Precautions .....	3
The Front Panel .....	4,5
Suggested Settings .....	6
System Block Diagram .....	7
Technical Specifications .....	back cover

 <b>CAUTION</b> RISK OF ELECTRIC SHOCK DO NOT OPEN	 <b>PRECAUCION</b> RIESGO DE CORRIENTAZO NO ABRA	 <b>ATTENTION</b> RISQUE D'ELECTROCUTION NE PAS OUVRIR
<small>WARNING: TO REDUCE THE RISK OF FIRE OR ELECTRIC SHOCK, DO NOT EXPOSE THIS APPARATUS TO RAIN OR MOISTURE. TO REDUCE THE RISK OF ELECTRIC SHOCK, DO NOT REMOVE COVER. NO USER-SERVICEABLE PARTS INSIDE. REFER SERVICING TO QUALIFIED SERVICE PERSONNEL.</small>	<small>PRECAUCION: PARA REDUCIR EL RIESGO DE INCENDIOS O DESCARGAS ELECTRICAS, NO PERMITA QUE ESTE APARATO QUEDE EXPUESTO A LA LLUVIA O LA HUMEDAD. PARA DISMINUIR EL RIESGO DE CORRIENTAZO, NO ABRA LA CUBIERTA. NO HAY PIEZAS ADENTRO QUE EL USUARIO PUEDE REPARAR DE JE TODO MANTENIMIENTO A LOS TECNICOS CALIFICADOS.</small>	<small>ATTENTION: PROTEGEZ CET APPAREIL DE LA PLUIE ET DE L'HUMIDITE AFIN D'EVITER TOUT RISQUE D'INCENDIE OU D'ELECTROCUTION. POUR REDUIRE D'ELECTROCUTION NE PAS ENLEVER LE COUVERCLE. AUCUNE PIECE INTERNE N'EST REPARABLE PAR L'UTILISATEUR. POUR TOUTE REPARATION, S'ADRESSER A UN TECHNICIEN QUALIFIE.</small>
<b>IMPORTANT SAFETY INSTRUCTIONS</b>		
<ul style="list-style-type: none"> <li>• READ, FOLLOW, HEED, AND KEEP ALL INSTRUCTIONS AND WARNINGS.</li> <li>• DO NOT OPERATE NEAR ANY HEAT SOURCE AND DO NOT BLOCK ANY VENTILATION OPENINGS ON THIS APPARATUS.</li> <li>• DO NOT USE THIS APPARATUS NEAR SPLASHING, FALLING, SPRAYING, OR STANDING LIQUIDS.</li> <li>• CLEAN ONLY WITH LINT-FREE DAMP CLOTH AND DO NOT USE CLEANING AGENTS.</li> <li>• ONLY CONNECT POWER CORD TO A POLARIZED, SAFETY GROUNDED OUTLET WIRED TO CURRENT ELECTRICAL CODES AND COMPATIBLE WITH VOLTAGE, POWER, AND FREQUENCY REQUIREMENTS STATED ON THE REAR PANEL OF THE APPARATUS.</li> <li>• PROTECT THE POWER CORD FROM DAMAGE DUE TO BEING WALKED ON, PINCHED, OR STRAINED.</li> <li>• UNPLUG THE APPARATUS DURING LIGHTNING STORMS OR WHEN UNUSED FOR LONG PERIODS OF TIME.</li> <li>• ONLY USE ATTACHMENTS, ACCESSORIES, STANDS, OR BRACKETS SPECIFIED BY THE MANUFACTURER FOR SAFE OPERATION AND TO AVOID INJURY.</li> <li>• THIS APPARATUS DOES NOT OPERATE NORMALLY AND REQUIRES SERVICE WITH ANY PHYSICAL DAMAGE FROM IMPACT OR ANY EXPOSURE TO MOISTURE.</li> <li>• SERVICE MUST BE PERFORMED BY QUALIFIED PERSONNEL.</li> <li>• OUR AMPLIFIERS ARE CAPABLE OF PRODUCING HIGH SOUND PRESSURE LEVELS. CONTINUED EXPOSURE TO HIGH SOUND PRESSURE LEVELS CAN CAUSE PERMANENT HEARING IMPAIRMENT OR LOSS. USER CAUTION IS ADVISED AND EAR PROTECTION IS RECOMMENDED IF UNIT IS OPERATED AT HIGH VOLUME.</li> </ul>		
<small>EXPLANATION OF GRAPHICAL SYMBOLS:          EXPLICACION DE SIMBOLOS GRAFICOS:          EXPLICATION DES SYMBOLES GRAPHIQUES:</small>	 = <small>"DANGEROUS VOLTAGE"          "VOLTAJE PELIGROSO"          "DANGER HAUTE TENSION"</small>	 = <small>"IT IS NECESSARY FOR THE USER TO REFER TO THE INSTRUCTION MANUAL"          "ES NECESARIO QUE EL USUARIO SE REFERIA AL MANUAL DE INSTRUCCIONES."          "REFERREZ-VOUS AU MANUAL D'UTILISATION"</small>

# MX15R Guitar Amplifier

---

## Important Safeguards and Precautions:

All Crate products are designed for continuous safe operation. Abiding by the following rules can help prevent damage to your amplifier, yourself and others.

- The amplifier is equipped with a three-pronged AC power cord. To reduce the risk of electrical shock, **NEVER** remove or otherwise attempt to defeat the ground pin of the power cord.
- Connect the amplifier **ONLY** to a properly grounded AC outlet of the proper voltage for your amp.
- Avoid sudden temperature extremes, rain and moisture. Also, avoid sudden and intense impact. (If the unit has been subjected to any of the preceding abuses, have it looked at by an authorized service center.)
- Do not expose the unit to splashing or dripping liquid. Do not place liquid filled objects on the unit.
- **NEVER** set the amplifier on a support that will not bear its weight.
- Always keep the total speaker impedance at or above the rated load.
- Unplug the amplifier before cleaning it. **NEVER** spray liquid cleaners onto the amplifier. Wipe it with a slightly dampened, lint-free cloth to remove dirt and film.
- **DO NOT** use the amplifier if it has sustained damage to the chassis, controls, or power cord. Refer the unit to an authorized service center for inspection.
- Prolonged exposure to high volume levels may cause permanent hearing loss or damage. Such damage is progressive and irreversible!

# MX15R Guitar Amplifier

## The Front Panel:

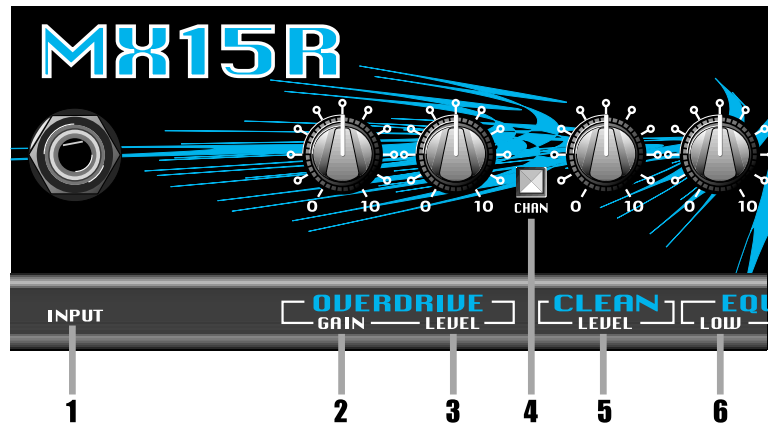

**1: INPUT:** Use this 1/4" jack to connect your guitar to the amplifier by means of a shielded instrument cable.

**OVERDRIVE CHANNEL:** *A high gain channel giving you sounds from a slight edge to serious overdrive.*

**2: GAIN:** Use this control to adjust the amount of distortion for the Overdrive channel. With the control counterclockwise, the sound will have a thick compressed quality. As you rotate the control clockwise the amount of distortion increases.

**3: LEVEL:** Use this control to adjust the output level of the Overdrive channel.

**4: CHANNEL SWITCH:** Use this switch to select either channel. With the switch in the out position, the Clean channel is selected. When the switch is depressed, the Overdrive channel is selected.

**CLEAN CHANNEL:** *A normal gain channel designed to give you crystal clear sounds to medium distortion.*

**5: LEVEL:** This control sets the output volume level from the Clean channel: in the full counterclockwise position there will be no output; as you rotate the control clockwise the output level increases. The full clockwise setting is maximum output - as you increase the level, roll back the Low control (#6).

### **EQUALIZATION:**

**6: LOW:** Use this control to adjust the low frequency level of the amplifier. Due to the massive amount of low end available, you may want to "roll off" the bass at high volumes.

**7: MID:** Use this control to adjust the midrange frequency level of the amplifier.

**8: HIGH:** Use this control to adjust the high frequency level of the amplifier.



# MX15R Guitar Amplifier

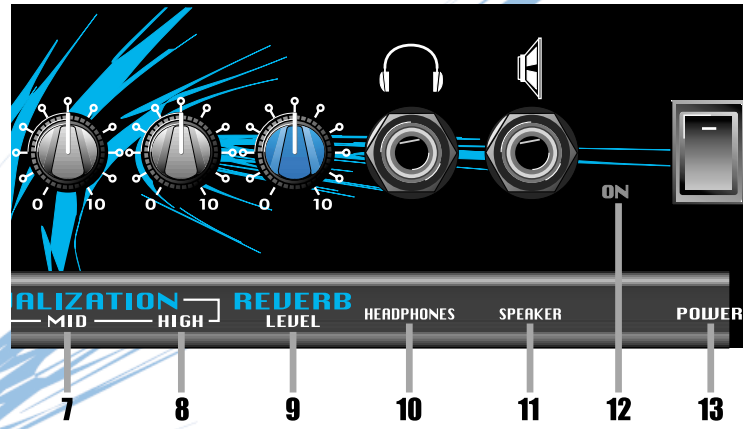

**9: REVERB LEVEL:** Use this control to adjust the amount of reverberation! in its full counter clockwise position the signal will be “dry” (without any reverb). As you rotate the control clockwise the amount of reverberation increases.

**10: HEADPHONES:** Use this jack to listen to the amplifier through a pair of stereo headphones. The internal speaker is disconnected when the headphones jack is used.

**CAUTION:** To avoid possible damage to your hearing, do not use headphones for extended periods of time at extremely loud listening levels.

**11: EXTERNAL SPEAKER:** Use this jack to connect the amplifier to an external speaker. The internal speaker is disconnected when this jack is used. The minimum impedance for the external speaker is 4 ohms.

**12: ON LED:** This LED will illuminate when power is applied to the amplifier.

**13: POWER:** Use this switch to turn the amplifier on and off.

**14: AC LINE CORD:** (Rear panel, not shown:) This grounded power cord is to be plugged into a grounded power outlet, wired to current electric codes and compatible with voltage, power, and frequency requirements stated on the rear panel. **Do not attempt to defeat the safety ground connection.**

# MX15R Guitar Amplifier

## Suggested Settings:

### Clean:

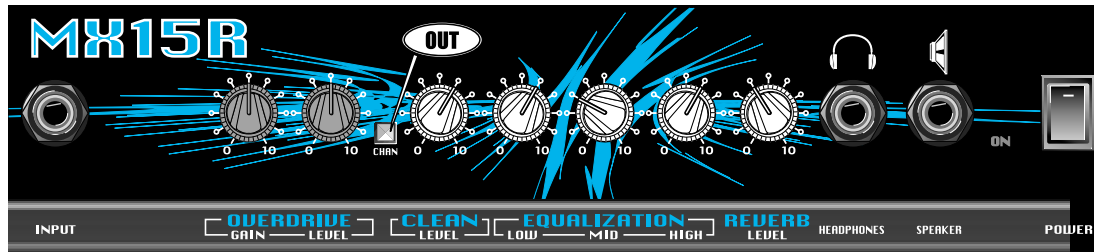

### Blues:

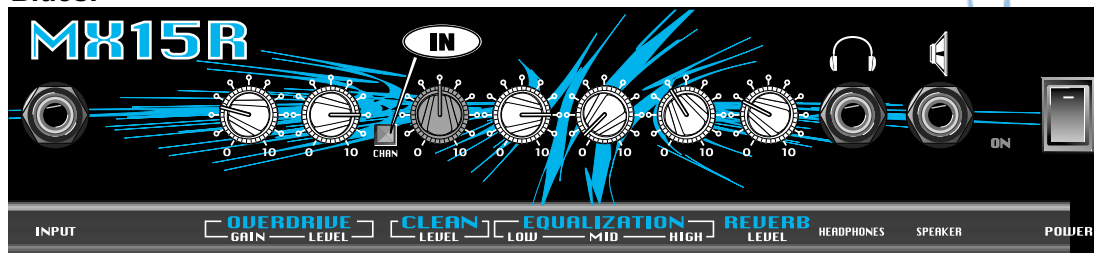

### Rhythm:

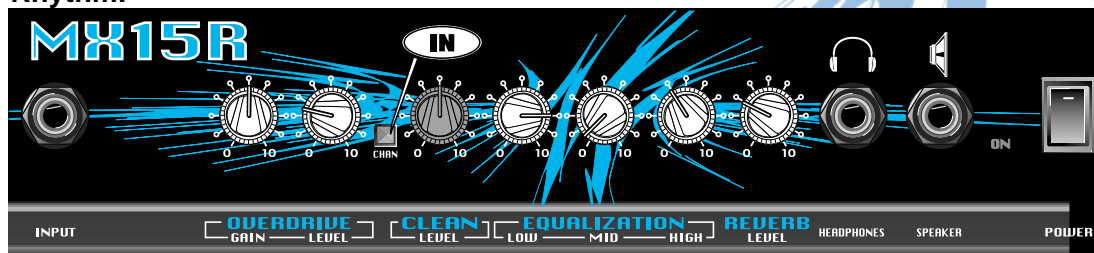

### Lead:

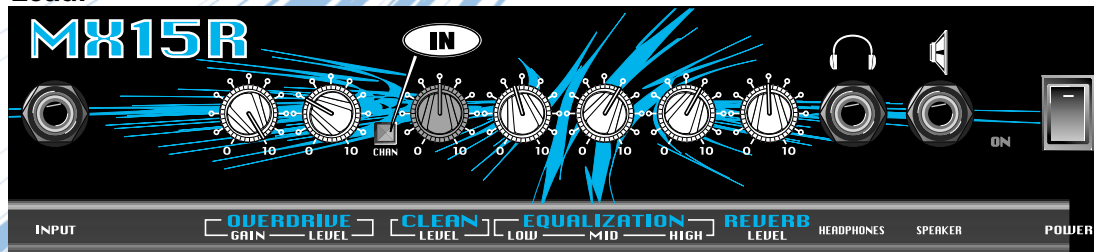

# MX15R Guitar Amplifier

## System Block Diagram:

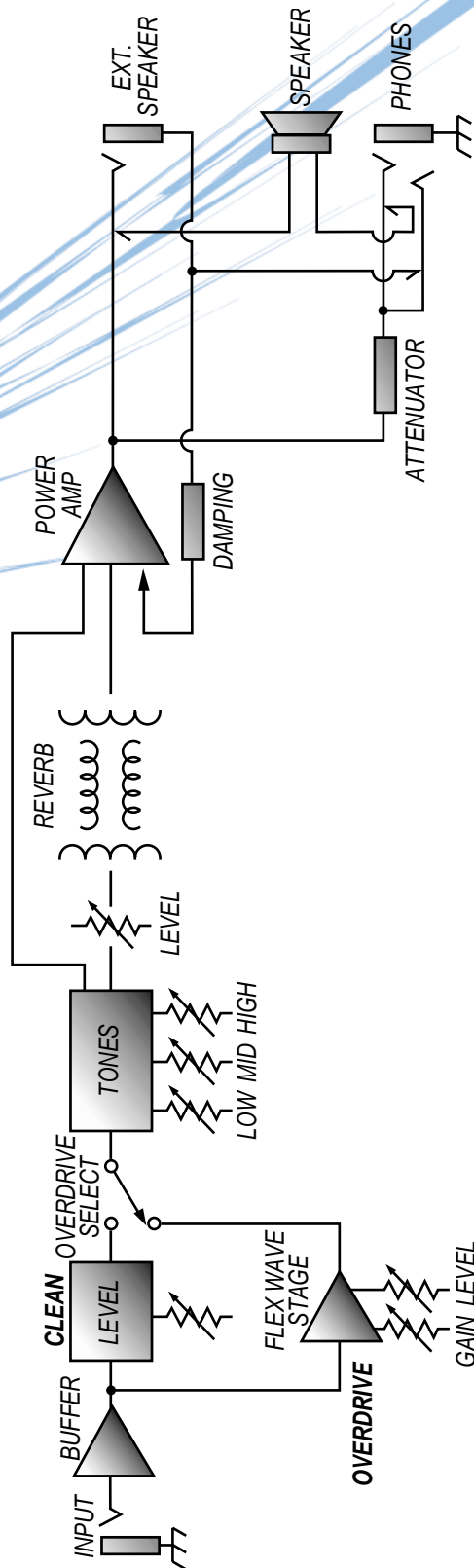

# MX15R Guitar Amplifier

## MX15R TECHNICAL SPECIFICATIONS:

Output Power Rating	12 watts RMS @ 5% THD 4 ohms, 120 VAC
Gain, Overdrive Channel	86 +/-6dB @ 1kHz
Gain, Clean Channel	46 +/-6dB @ 1kHz
Tone Control Range, Low	25dB @ 80Hz
Tone Control Range, Mid	19dB @ 900Hz
Tone Control Range, High	23dB @ 5kHz
Signal To Noise, Overdrive Channel	>50dB
Signal To Noise, Clean Channel	>65dB
Maximum Input Signal Accepted	2.2 volts RMS
Internal Speaker	8" Crate Custom Design, 4 ohm
Power Requirements	120 VAC, 60Hz, 30VA 100/115VAC, 50/60Hz, 30VA 100/115VAC, 50/60Hz, 30VA
Size and Weight	13" H x 13.5" W x 8.25" D, 15 lbs.

**The MX15R is covered with a durable black Tolex material: wipe it clean with a lint-free cloth. Never spray cleaning agents onto the cabinet. Avoid abrasive cleansers which would damage the finish.**

*Crate continually develops new products, as well as improves existing ones. For this reason, the specifications and information in this manual are subject to change without notice.*



# CRATE

[www.crateamps.com](http://www.crateamps.com)

©2001 SLM Electronics, a division of St. Louis Music, Inc • 1400 Ferguson Avenue • St. Louis, MO 63301  
47-447-52 • 02/01



## Free Manuals Download Website

<http://myh66.com>

<http://usermanuals.us>

<http://www.somanuals.com>

<http://www.4manuals.cc>

<http://www.manual-lib.com>

<http://www.404manual.com>

<http://www.luxmanual.com>

<http://aubethermostatmanual.com>

Golf course search by state

<http://golfingnear.com>

Email search by domain

<http://emailbydomain.com>

Auto manuals search

<http://auto.somanuals.com>

TV manuals search

<http://tv.somanuals.com>