

CRATE

ST. LOUIS MISSOURI USA

VC-508 Guitar Amplifier



Owners Manual

Conratulations!

You are now the proud owner of the Crate VC-508 Guitar Amplifier. This powerful little unit packs a whole lot of vintage tube sound into its compact cabinet – giving you an amp that’s small and easy to operate yet still produces incredible sounds!

All Crate amplifiers are Musician Made with Pride in the U.S.A. using the finest components available. Each amp is rigorously tested by skilled technicians and musicians to ensure that your amplifier is the best it can be.

For best results please read this manual before using the amplifier. And Thank You for choosing **CRATE!**

The Controls and their Functions:

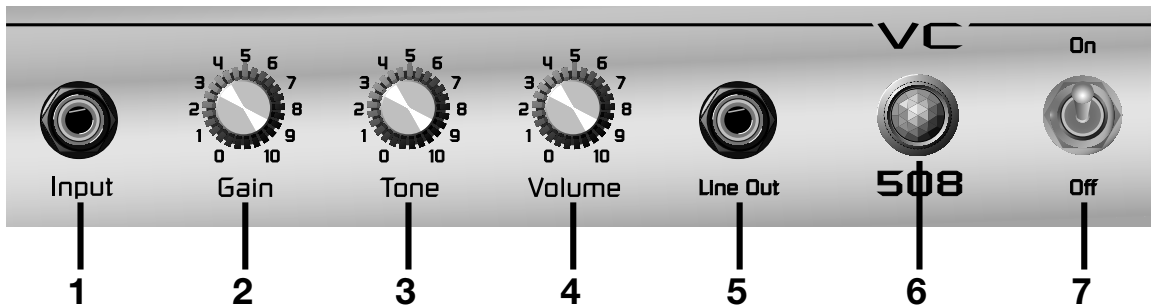

1. INPUT: Plug your guitar in here. Use a shielded instrument patch cord for this.

2. GAIN: This determines the amount of overdrive distortion. At low settings (the 1 - 3 range) the signal is clean and low. As the control is turned up the signal becomes more overdriven and louder. Use this along with the Volume control (#4) and the volume control on your guitar for a wide variety of sounds.

3. TONE: This control lets you quickly “dial in” just the right sounds. Basically, rotating the control towards the left enhances the mid frequencies; rotating it to the right enhances more of the low and high frequencies simultaneously, with a myriad of tonal variations in between.

4. VOLUME: This control varies the output level of the amplifier. Use this control along with the Gain control (#2) to obtain the level you need. The Volume control also governs the level of the signal at the Line Out jack (#5).

5. LINE OUT: This jack provides a line level signal for connecting to a house mixing board, recording console or external amplifier. This jack can also double as in Insert jack, allowing you to add an external effect, as shown on the facing page. The jack is a stereo 1/4” type: tip = signal out, ring = signal in, sleeve = ground.

6. POWER LIGHT: This jeweled lens glows when the amplifier is turned on.

7. POWER SWITCH: This heavy duty switch turns the amp on and off. Allow a few seconds once the amp is turned on to let the tubes warm up.

AC LINE CORD (rear of amplifier, not shown): Plug this cord into a *grounded* outlet of the proper voltage and current. See the sticker on the underside of the chassis for the amplifier’s power requirements.



System Block Diagram:

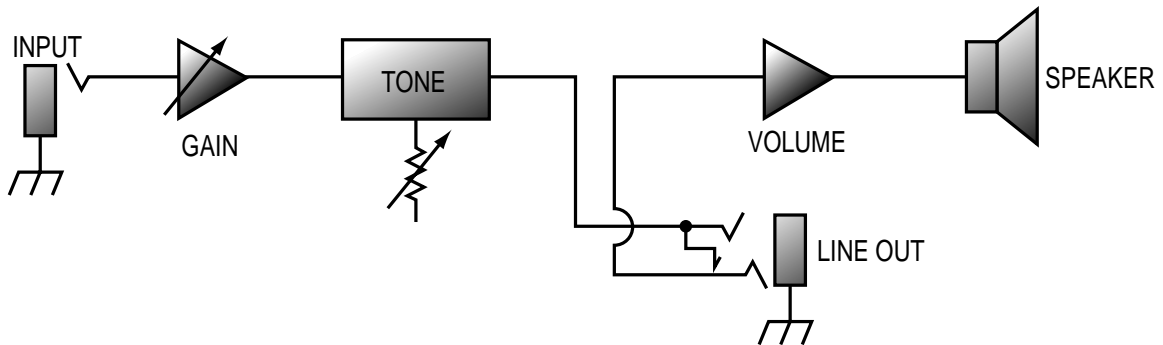

Using the Line Out as an Insert Jack:



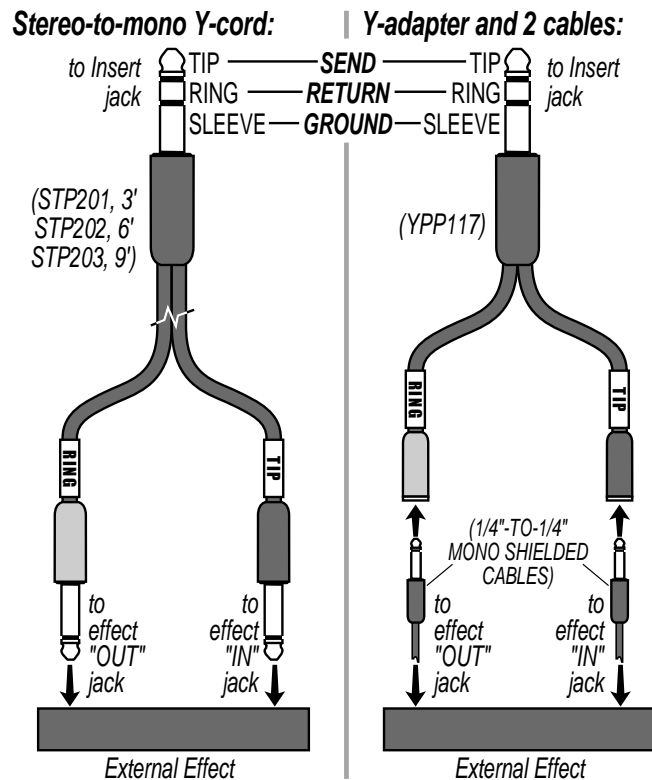

The line out jack can also serve as an Insert jack, allowing you to patch external effects into the amplifier just prior to its power amp stage. Use Crate's STP201, STP202 or STP203 stereo-to-mono Y-cord or an adapter such as Crate's YPP117 and two 1/4" mono signal cables to connect to the effect as shown:



VC-508

Technical Specifications:

OUTPUT POWER RATING	5 W RMS @ 10%THD, 8 ohm load, 120 VAC
INPUT IMPEDANCE	1M ohm
MAX. SIGNAL ACCEPTED	2.5v peak-to-peak
SIGNAL TO NOISE RATIO	66dB
GAIN	58dB
tone CONTROL	+/-16dB @ 1kHz
LINE OUT LEVEL	80mV RMS
INTERNAL SPEAKER	8", 8 ohm, 15W Crate Custom
POWER REQUIREMENTS	120VAC, 60Hz, 40VA 100/115VAC, 50/60Hz, 40VA 230VAC, 50/60Hz, 40VA
SIZE AND WEIGHT	12" H x 13" W x 7.5"D; 18 lbs.

 CAUTION RISK OF ELECTRIC SHOCK DO NOT OPEN	<p>THIS EQUIPMENT HAS BEEN DESIGNED AND ENGINEERED TO PROVIDE SAFE AND RELIABLE OPERATION. IN ORDER TO PROLONG THE LIFE OF THE UNIT AND PREVENT ACCIDENTAL DAMAGES OR INJURY, PLEASE FOLLOW THESE PRECAUTIONARY GUIDELINES:</p> <p>CAUTION: TO REDUCE THE RISK OF ELECTRIC SHOCK, DO NOT OPEN CHASSIS; DO NOT DEFEAT OR REMOVE THE GROUND PIN OF THE POWER CORD; CONNECT ONLY TO A PROPERLY GROUNDED AC POWER OUTLET.</p> <p>WARNING: TO REDUCE THE RISK OF FIRE OR ELECTRIC SHOCK, DO NOT EXPOSE THIS EQUIPMENT TO RAIN OR MOISTURE.</p> <p>CAUTION: NO USER-SERVICEABLE PARTS INSIDE. REFER SERVICING TO QUALIFIED SERVICE PERSONNEL.</p> <p>CAUTION: OUR AMPLIFIERS ARE CAPABLE OF PRODUCING HIGH SOUND PRESSURE LEVELS. CONTINUED EXPOSURE TO HIGH SOUND PRESSURE LEVELS CAN CAUSE PERMANENT HEARING IMPAIRMENT OR LOSS. USER CAUTION IS ADVISED AND EAR PROTECTION IS RECOMMENDED IF UNIT IS OPERATED AT HIGH VOLUME.</p>	<p>ESTE APARATO HA SIDO DISEÑADO Y CONSTRUÍDO PARA PROVEER AÑOS DE OPERACION SEGURA Y CONFIABLE. PARA PROLONGAR LA VIDA DE ESTA UNIDAD E IMPEDIR DANOS ACCIDENTALES POR FAVOR SIGA ESTAS INSTRUCCIONES PREVENTIVAS:</p> <p>PRECAUCION: PARA DISMINUIR EL RIESGO DE DESCARGAS ELECTRICAS: (1) NO ABRA LA CUBIERTA, (2) NO ES RECOMENDABLE REMOVER O DESACTIVAR LA PATA DEL POLO A TIERRA DEL CABLE DE CORRIENTE, CONECTE CORRECTAMENTE A UNA TOMA DE CORRIENTE A TIERRA.</p> <p>ADVERTENCIA: PARA EVITAR DESCARGAS EL ECTRICAS O PELIGRO DE INCENDIO, NO DEJE ESTE APARATO EXPUESTO A LA LLUVIA O HUMEDAD.</p> <p>PRECAUCION: NO HAY PIEZAS ADENTRO QUE EL USUARIO PUEDE REPARAR. DEJE TODO MANTENIMIENTO A LOS TÉCNICOS CALIFICADOS.</p> <p>PRECAUCION: NUESTROS AMPLIFICADORES PUEDEN PRODUCIR NIVELES DE PRESION DE SONIDO ALTO. EXPOSICION CONTINUADA A LOS NIVELES DE PRESION DE SONIDO ALTO PUEDE CAUSA DANO PERMANENTE A SU OIDO. ES ACONSEJADO QUE USE PRECAUCIONAL USUARIO Y ES RECOMENDADO PROTECCION PARA LOS OIDOS SI LA UNIDAD ES OPERADA A VOLUMEN ALTO.</p>	<p>CET ÉQUIPEMENT AVAIT ÉTÉ INVENTÉ ET ARRANGÉ POUR POURVOIR DES ANNÉES D'USAGE SAUF ET SÛR. POUR PROLONGER LA VIE DE CET APPAREIL ET POUR EMPÊCHER LES DOMMAGES ET LES TORTS ACCIDENTELS, SUIVEZ LES INSTRUCTIONS DE PRÉCAUTION.</p> <p>AVERTISSEMENT: POUR RÉDUIRE LES RISQUES D'ÉLECTROCUSSION: (1) N'OUVREZ PAS LE CHÂSSIS, (2) NE PAS ESSAYER DE SUPPRIMER LA BROCHE CORRESPONDANT À LA TERRE.</p> <p>ATTENTION: POUR RÉDUIRE LES RISQUES D'UN FEU OU D'ÉLECTROCUSSION, N'EXPOSEZ PAS L'APPAREIL À LA PLUIE OU À LA MOI-TEUR.</p> <p>ATTENTION: IL NY A PAS D'ÉLÉMENTS RÉPARABLES DANS L'APPAREIL. CONSULTER UN TECHNICIEN QUALIFIÉ POUR LES RÉPARATIONS.</p> <p>ATTENTION: NOS AMPLIFICATEURS SONT CAPABLES DE LA PRODUCTION DES NIVEAUX DE SON D'UNE HAUTE PRESSION. L'EXPOSITION CONTINUE AUX CES NIVEAUX PEUT CAUSER LA SURDITÉ PERMANENTE. LA PRUDENCE EST ADVISÉ À UTILISATEUR ET LA PROTECTION DES OREILLES EST RECOMMANDÉ SI L'APPAREIL EST UTILISÉ À UN HAUT NIVEAU DE VOLUME.</p>
 PRECAUCION RIESGO DE CORRIENTAZO NO ABRA			
 ATTENTION RISQUE D'ELECTROCUSSION NE PAS OUVRIIR			
 VORSICHT ELEKTRISCHE SCHLAGEGFAHR NICHT OFFENEN			
<p>EXPLANATION OF GRAPHICAL SYMBOLS: EXPLICACION DE SIMBOLOS GRAFICOS: EXPLICATION DES SYMBOLES GRAPHIQUES:</p>			

Crate continually develops new products, as well as improves existing ones. For this reason, the specifications and information in this Crate manual are subject to change without notice.



www.crateamps.com



©2001 SLM Electronics • A division of St. Louis Music
 1400 Ferguson Avenue • St. Louis, MO 63133

P/N 47-451-01
 05/01

Free Manuals Download Website

<http://myh66.com>

<http://usermanuals.us>

<http://www.somanuals.com>

<http://www.4manuals.cc>

<http://www.manual-lib.com>

<http://www.404manual.com>

<http://www.luxmanual.com>

<http://aubethermostatmanual.com>

Golf course search by state

<http://golfingnear.com>

Email search by domain

<http://emailbydomain.com>

Auto manuals search

<http://auto.somanuals.com>

TV manuals search

<http://tv.somanuals.com>