

CRATE

VTX65

**Three-Channel Guitar Amplifier
with Advanced Digital Signal
Processing**



User's Guide

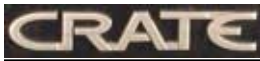

TABLE OF CONTENTS:

Introduction3

The Top Panel4,5

The Bottom Panel6

The DSP Section7

Storing Your Own Presets8

Restoring the Factory Presets8

More About The Save/Tap Button8

Using the Footswitch for More Presets9

DSP Factory Presets10,11

Suggested Settings12,13

DSP “Fill in the Blanks” (for User Presets)14

System Block Diagram15

Technical Specificationsback cover

This equipment has been tested and found to comply with the limits for a Class B digital device, pursuant to part 15 of the FCC Rules. These limits are designed to provide reasonable protection against harmful interference in a residential installation. This equipment generates, uses and can radiate radio frequency energy and, if not installed and used in accordance with the instructions, may cause harmful interference to radio communications. However, there is no guarantee that interference will not occur in a particular installation. If this equipment does cause harmful interference to radio or television reception, which can be determined by turning the equipment off and on, the user is encouraged to try to correct the interference by one or more of the following measures:

- Reorient or relocate the receiving antenna.
- Increase the separation between the equipment and the receiver.
- Connect the equipment into an outlet on a circuit different from that to which the receiver is connected.
- Consult the dealer or an experienced radio/TV technician for help.

Changes or modifications to this device not expressly approved by SLM Electronics could void the user’s authority to operate the equipment under FCC rules.

Declaration of Conformity

Manufacturer’s Name: SLM Electronics
Corporate Headquarters: 1901 Congressional Drive, St. Louis, Missouri 63146
Primary Production Facility: 700 Hwy 202 W, Yellville, Arkansas, 72687

Product Type: Audio Amplifier

Products meet the regulations for compliance marking under:

- ETL standards UL6500, UL60065, or UL813
- CSA standards E60065 or C22.2 No.1-M90
- CE safety standard EN60065
- CE EMC standards EN55103 or EN55013 and EN61000
- C-tick designation Level 2, ABN #56748810738, ARBN# N222
- KETI standard K60065 (limited model approval)

Compliance Support Contact: SLM Electronics, Attn: R&D Compliance Engineer
 1901 Congressional Drive, St Louis, Missouri, 63146 • Tel.: 314-569-0141, Fax: 314-569-0175





Congratulations!

You are now the proud owner of the Crate VTX65 three-channel guitar amplifier with Advanced Digital Signal Processing. This rugged amplifier combines outstanding features with serious clean and distorted sounds. Dual DSP controls provide 15 “Multi” effects and 15 Delay effects which can be combined for a wide variety of sounds. The Save/Tap button allows you to manually set the tempo of many of the effects and to save new DSP presets in the amplifier’s non-volatile memory. A separate Reverb control adds even more to the array of effects. Front panel RCA CD Input jacks allow you to play along with your favorite CD or tape. The rear panel Insert Jack allows you to connect your effects for greater flexibility. Channel switching and DSP may be controlled by means of a footswitch, which also allows access to two DSP presets on each of the three channels. The top-mounted electronic tuner lets you get tuned and stay in tune any time the amplifier is on.

Like all Crate products, your VTX65 amplifier is designed by musicians, and built using only the best components. Extensive testing confirms that this amplifier is the absolute best it can be.

In order to get the most out of your new amplifier, we strongly suggest that you read the information contained in this guide before you begin playing.

And **thank you** for choosing **CRATE**.

| | | |
|---|---|---|
|  CAUTION RISK OF ELECTRIC SHOCK DO NOT OPEN |  PRECAUCION RIESGO DE CORRIENTAZO NO ABRA |  ATTENTION RISQUE D'ELECTROCUTION NE PAS OUVRIR |
| WARNING: TO REDUCE THE RISK OF FIRE OR ELECTRIC SHOCK, DO NOT EXPOSE THIS APPARATUS TO RAIN OR MOISTURE. TO REDUCE THE RISK OF ELECTRIC SHOCK, DO NOT REMOVE COVER. NO USER-SERVICEABLE PARTS INSIDE. REFER SERVICING TO QUALIFIED SERVICE PERSONNEL. | PRECAUCION: PARA REDUCIR EL RIESGO DE INCENDIOS O DESCARGAS ELECTRICAS, NO PERMITA QUE ESTE APARATO QUEDE EXPUESTO A LA LLUVIA O LA HUMEDAD. PARA DISMINUIR EL RIESGO DE CORRIENTAZO, NO ABRA LA CUBIERTA. NO HAY PIEZAS ADENTRO QUE EL USUARIO PUEDE REPARAR DEJE TODO MANTENIMIENTO A LOS TECNICOS CALIFICADOS. | ATTENTION: PROTEGEZ CET APPAREIL DE LA PLUIE ET DE L'HUMIDITE AFIN D'EVITER TOUT RISQUE D'INCENDIE OU D'ELECTROCUTION. POUR REDUIRE D'ELECTROCUTION NE PAS ENLEVER LE COUVERCLE. AUCUNE PIECE INTERNE N'EST REPRABLE PAR L'UTILISATEUR. POUR TOUTE REPARATION, S'ADRESSER A UN TECHNICIEN QUALIFIE. |
| IMPORTANT SAFETY INSTRUCTIONS | | |
| <ul style="list-style-type: none"> • READ, FOLLOW, HEED, AND KEEP ALL INSTRUCTIONS AND WARNINGS. • DO NOT OPERATE NEAR ANY HEAT SOURCE AND DO NOT BLOCK ANY VENTILATION OPENINGS ON THIS APPARATUS. FOR PROPER OPERATION, THIS UNIT REQUIRES 3" (75mm) OF WELL VENTILATED SPACE AROUND HEATSINKS AND OTHER AIR FLOW PROVISIONS IN THE CABINET. • DO NOT USE THIS APPARATUS NEAR SPLASHING, FALLING, SPRAYING, OR STANDING LIQUIDS. • CLEAN ONLY WITH LINT-FREE DAMP CLOTH AND DO NOT USE CLEANING AGENTS. • ONLY CONNECT POWER CORD TO A POLARIZED, SAFETY GROUNDED OUTLET WIRED TO CURRENT ELECTRICAL CODES AND COMPATIBLE WITH VOLTAGE, POWER, AND FREQUENCY REQUIREMENTS STATED ON THE REAR PANEL OF THE APPARATUS. • PROTECT THE POWER CORD FROM DAMAGE DUE TO BEING WALKED ON, PINCHED, OR STRAINED. • UNPLUG THE APPARATUS DURING LIGHTNING STORMS OR WHEN UNUSED FOR LONG PERIODS OF TIME. • ONLY USE ATTACHMENTS, ACCESSORIES, STANDS, OR BRACKETS SPECIFIED BY THE MANUFACTURER FOR SAFE OPERATION AND TO AVOID INJURY. • WARNING: TO REDUCE THE RISK OF ELECTRIC SHOCK OR FIRE, DO NOT EXPOSE THIS UNIT TO RAIN OR MOISTURE.. • SERVICE MUST BE PERFORMED BY QUALIFIED PERSONNEL. • OUR AMPLIFIERS ARE CAPABLE OF PRODUCING HIGH SOUND PRESSURE LEVELS. CONTINUED EXPOSURE TO HIGH SOUND PRESSURE LEVELS CAN CAUSE PERMANENT HEARING IMPAIRMENT OR LOSS. USER CAUTION IS ADVISED AND EAR PROTECTION IS RECOMMENDED IF UNIT IS OPERATED AT HIGH VOLUME. | | |
| EXPLANATION OF GRAPHICAL SYMBOLS: EXPLICACION DE SIMBOLOS GRAFICOS: EXPLICATION DES SYMBOLES GRAPHIQUES: |  = "DANGEROUS VOLTAGE" "VOLTAJE PELIGROSO" "DANGER HAUTE TENSION" |  = "IT IS NECESSARY FOR THE USER TO REFER TO THE INSTRUCTION MANUAL" "ES NECESARIO QUE EL USUARIO SE REFIERA AL MANUAL DE INSTRUCCIONES." "REFERREZ-VOUS AU MANUAL D'UTILISATION" |

CRATE VTX65 Three-Channel Guitar Amplifier with Advanced DSP

The Top Panel:

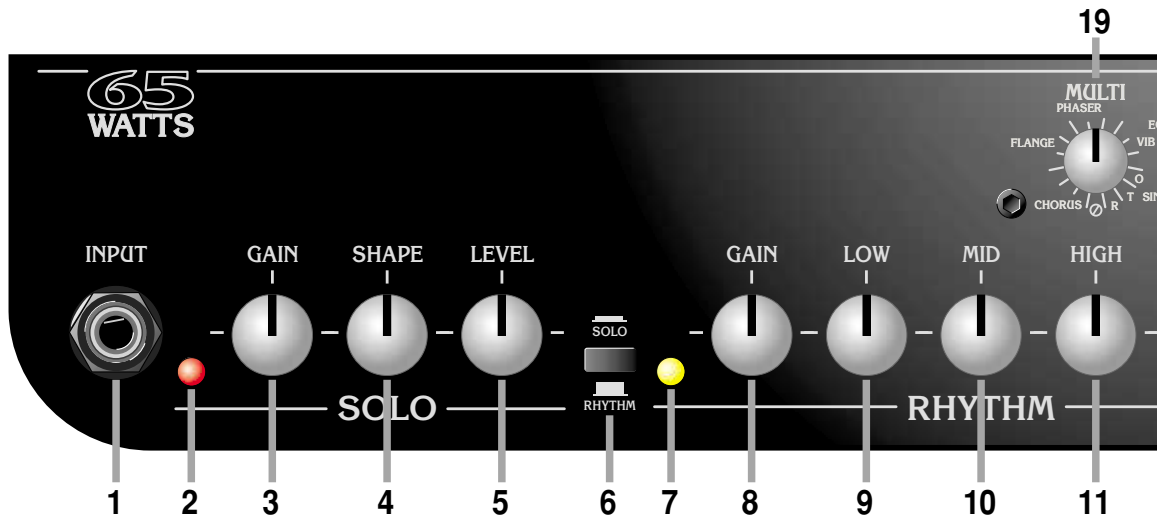

1: INPUT: Use this jack to connect your guitar to the amplifier by means of a shielded instrument cable.

SOLO/RHYTHM CHANNELS: High gain channels giving you sounds with serious overdrive.

2: SOLO LED: This LED illuminates when the Solo channel is selected.

3: GAIN: Use this control to adjust the amount of distortion produced by the Solo channel.

4: SHAPE: Use this control to “dial in” the tone for the Solo channel. Rotating the control counter-clockwise enhances the mid frequencies, while rotating the control clockwise enhances the low and high frequencies.

5: LEVEL: Use this control to adjust the output level of the Solo channel.

6: SOLO/RHYTHM: Use this switch to select the Solo or Rhythm channel. When this switch is depressed, the Solo channel is selected. With the switch in the out position, the Rhythm channel is selected. This switch is active only when the Solo/Rhythm/Clean switch (#13) is depressed.

7: RHYTHM LED: This LED illuminates when the Rhythm channel is selected.

8: GAIN: Use this control to adjust the amount of distortion produced by the Rhythm channel.

9: LOW: Use this control to adjust the low frequency level of the Solo/Rhythm channel.

10: MID: Use this control to adjust the midrange frequency level of the Solo/Rhythm channel.

11: HIGH: Use this control to adjust the high frequency level of the Solo/Rhythm channel.

12: LEVEL: Use this control to adjust the output level of the Rhythm channel.

13: SOLO/RHYTHM/CLEAN SELECT: Use this switch to select the Clean channel or the Solo and Rhythm channels. With the switch in the out position, the Clean channel is selected. When the switch is depressed, either the Solo or Rhythm channel is selected, depending on the setting of the Solo/Rhythm switch (#6).

CLEAN CHANNEL: A normal gain channel designed to give you crystal clean sounds.

14: CLEAN LED: This LED illuminates when the Clean channel is selected.

15: VOLUME: Use this control to adjust the output level of the Clean channel.

16: LOW: Use this control to adjust the low frequency level of the Clean channel.

CRATE VTX65 Three-Channel Guitar Amplifier with Advanced DSP



17: MID: Use this control to adjust the midrange frequency level of the Clean channel.

18: HIGH: Use this control to adjust the high frequency level of the Clean channel.

19: CD INPUT: Use these RCA jacks to connect the output from a CD player or tape deck to the amplifier. The signal at these jacks is combined into a mono signal which is sent to the internal power amp circuit. Use the CD or tape player's output level control to adjust the signal for the proper mix with your guitar.

20: MULTI: Use this control to select one of the fifteen "Multi" digital effects. Complete information about the DSP effects is on page 7.

21: DELAY: Use this control to select one of the fifteen Delay digital effects. Complete information about the DSP effects is on page 7.

22: SAVE/TAP: Use this pushbutton to set the tempo of many of the effects by tapping the button repeatedly in time with the desired tempo. The Save/Tap button is also used to save DSP presets and to restore the factory default DSP settings. Additional information about the Save/Tap button is on pages 7 and 8.

23: SAVE/TAP LED: This LED flashes in time with the tempo set by the Save/Tap button (#22), and serves as a status indicator for certain DSP activities (see page 8).

NOTE: For some of the DSP effects, the Save/Tap LED remains illuminated. The Save/Tap LED does not illuminate when the DSP knobs are set to the Bypass position.

24. REVERB: Use this control to adjust the amount of digital reverb effect. In its fully counterclockwise position the signal will be "dry" (without any reverb). As you rotate the control clockwise the amount of reverb increases.

25: POWER: Use this switch to turn the amplifier on (top of the switch depressed) and off (bottom of the switch depressed). The switch illuminates when the power is on.

NOTE: When the amplifier is turned on, the Save/Tap LED flashes for one second before the amplifier is operational.

26: ELECTRONIC TUNER (cabinet top, not shown): The electronic tuner is active whenever the amplifier is turned on, providing constant, "real-time" tuning. The bottom row of LEDs indicate which note (string) is being tuned. The top row of LEDs provides directional queues to facilitate quick and precise tuning of your instrument. The indicated note (string) is properly tuned when only the center LED is illuminated.

The Bottom Panel:



27: FUSE: The fuse protects the amplifier from damages caused by a faulty AC power source and/or other problems. If the fuse opens, replace it **ONLY** with the same size and type. If fuses continue to fail, check the AC source – if the source is okay, contact your Crate dealer for service information.

28: EXTENSION SPEAKER: Use this jack to connect the amplifier to an external speaker cabinet. This jack is wired in series with the internal speaker(s) which remain active when an extension speaker is connected.

29: DSP A/B FOOTSWITCH: Use this jack to connect one of the footswitch cables to the three-button footswitch (supplied). This allows you to select between two presets for each of the three channels. Additional information about the operation of the footswitch is on page 9.

30: CLEAN/SOLO/RHYTHM FOOTSWITCH: Use this jack to connect one of the footswitch cables to the three-button footswitch (supplied). This allows you to remotely switch between the Clean and Distortion channels and between the Solo and Rhythm channels. (See page 9.)

31: INSERT: Use this jack to connect an external signal processor to the amplifier. Use Crate's STP201, STP202, or STP203 stereo-to-mono Y-cord or an adapter such as Crate's YPP117 and two 1/4" mono signal cables to connect to the effect as shown below.

32: AC LINE CORD (not shown): This grounded power cord is to be plugged into a grounded power outlet, wired to current electrical codes and compatible with the voltage, power, and frequency requirements stated on the bottom panel. **Do not attempt to defeat the safety ground connection.**

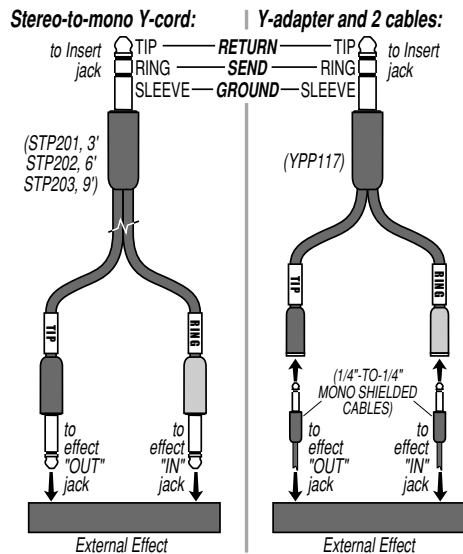

The DSP Section:

The VTX65 features DSP controls for Multi, Delay and Reverb. Complete information about the Multi and Delay



effects is given below. The Multi control selects the “pitch modified” and wah effects. Many of these effects have their speed controlled by the Save/Tap button. The Delay control selects the delay or echo effects. All of these effects have their speed controlled by the Save/Tap button. Additional information is provided on pages 5 and 10.

SIGNAL PATH FOR ECHO LO, MID & HI EFFECTS:

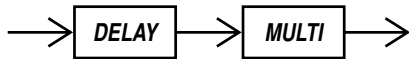

SIGNAL PATH FOR ALL OTHER EFFECTS:

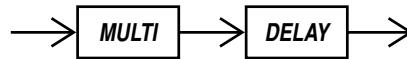

| MULTI: | | |
|---------------|------------------------------|---|
| NAME | DESCRIPTION | SAVE/TAP BUTTON CONTROLS: |
| Chorus LO | Chorus w/low depth | speed: 1 cycle/tap - tap period: .05–1 second |
| Chorus MID | Chorus w/medium depth | speed: 1 cycle/tap - tap period: .05–1 second |
| Chorus HI | Chorus w/high depth | speed: 1 cycle/tap - tap period: .05–1 second |
| Flange LO | Flanger w/low depth | speed: 4 cycle/tap - tap period: .05–1 second |
| Flange MID | Flanger w/medium depth | speed: 4 cycle/tap - tap period: .05–1 second |
| Flange HI | Flanger w/high depth | speed: 4 cycle/tap - tap period: .05–1 second |
| Phaser LO | Phaser w/low feedback | speed: 2 cycle/tap - tap period: .05–1 second |
| Phaser MID | Phaser w/medium feedback | speed: 2 cycle/tap - tap period: .05–1 second |
| Phaser HI | Phaser w/high feedback | speed: 2 cycle/tap - tap period: .05–1 second |
| Vibrato LO | Vibrato w/low depth | speed: 1 cycle/tap - tap period: .05–1 second |
| Vibrato MID | Vibrato w/medium depth | speed: 1 cycle/tap - tap period: .05–1 second |
| Vibrato HI | Vibrato w/high depth | speed: 1 cycle/tap - tap period: .05–1 second |
| Octave Down | Adds signal one octave lower | n/a |
| Touch Wah | Touch-sensitive wah-wah | n/a |
| Reverse Wah | Inverted wah-wah | n/a |
| Bypass | Dry signal - no effect | n/a |

| DELAY: | | |
|---------------|--|----------------------------------|
| NAME | DESCRIPTION | SAVE/TAP BUTTON CONTROLS: |
| Single LO | Single delay w/low level | time: .05–1 second |
| Single MID | Single delay w/medium level | time: .05–1 second |
| Single HI | Single delay w/high level | time: .05–1 second |
| Single MAX | Single delay w/maximum level | time: .05–1 second |
| Echo LO | Echo w/low level | time: .05–1 second |
| Echo MID | Echo w/medium level | time: .05–1 second |
| Echo HI | Echo w/high level | time: .05–1 second |
| Echo MAX | Echo w/maximum level | time: .05–1 second |
| Tape LO | Tape echo w/low level | time: .05–1 second |
| Tape MID | Tape echo w/medium level | time: .05–1 second |
| Tape HI | Tape echo w/high level | time: .05–1 second |
| Tape MAX | Tape echo w/maximum level | time: .05–1 second |
| Echo FX LO | Echo w/low level, before multi effect | time: .05–1 second |
| Echo FX MID | Echo w/medium level, before multi effect | time: .05–1 second |
| Echo FX HI | Echo w/high level, before multi effect | time: .05–1 second |
| Bypass | Dry signal - no effect | n/a |

Storing Your Own Presets:

Each channel of the VTX65 has two factory assigned DSP presets, as shown on pages 10 and 11. No matter what the settings of the DSP controls, the preset is recalled when a channel is selected. You may change the DSP settings by rotating the DSP controls - these changes will remain active until a different channel is selected, but will not be there for later use unless they are saved. To save a new DSP preset to a channel, first make the desired DSP changes. Then press and hold the Save/Tap button for about three seconds. The Save/Tap LED will flash through three quick sequences, indicating the preset was saved. The new preset is stored for that channel and will remain in memory until a new preset is stored for that channel or the factory presets are restored.

We recommend making copies of page 14 of this guide for the purpose of writing down your own presets.

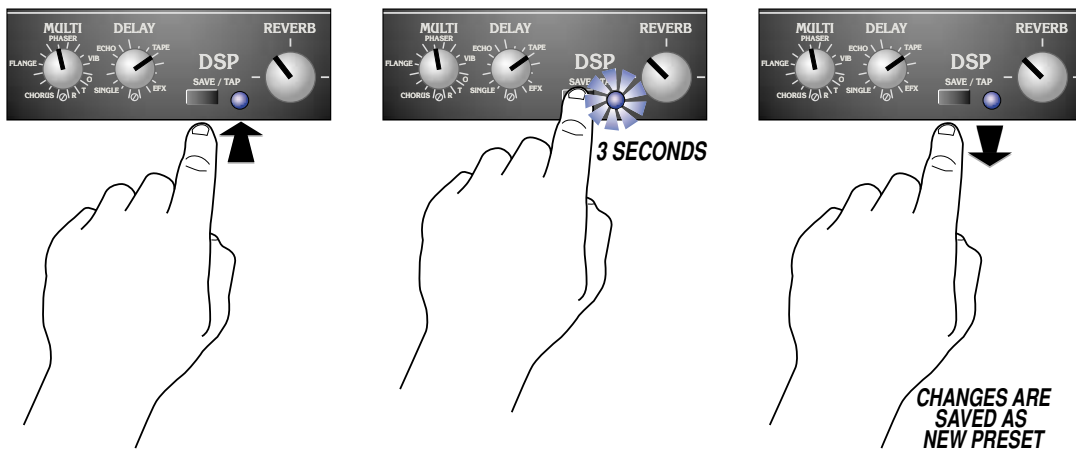

Restoring the Factory Presets:

The factory assigned DSP presets may be restored, erasing any changes you have made. Turn the amplifier off. Press and hold the Save/Tap button as you turn the amplifier on. The Save/Tap LED will flash through two quick sequences, indicating the factory presets have been restored.

More About the Save/Tap Button:

The Save/Tap button is used to set the tempo of an effect by pressing it twice within a one second time frame. The time between the two taps sets the timing of the effect. If the Save/tap button is pressed an odd number of times (once, three times, etc.), the timing will default to the maximum one second time period.

The Multi effects and the Delay effects may each have a different tap speed. The default "target" for the Save/Tap button is the Delay control. To select the Multi control as the tap button's target, rotate the Multi control. The Save/Tap tempo function will automatically revert back to the Delay control 16 seconds after the Multi control is rotated, or when the tap speed was last changed for the Multi effect.

NOTE: In most cases, it is usually more pleasing to the ear to set a slower tap speed for the HI effects and a faster tap speed for the LO effects.

CRATE VTX65 Three-Channel Guitar Amplifier with Advanced DSP

Using the Footswitch for More Presets:

The Crate three-button footswitch supplied with the VTX65 allows access to an additional DSP preset for each channel of the amplifier. When the footswitch is connected to the amplifier as shown below, the “original” DSP presets are active for each channel when the #3 footswitch LED is illuminated. These are referred to as “DSP Bank ‘A.’” When the #3 button is switched and the LED is out, a second DSP preset may be stored and recalled for each channel - “DSP Bank ‘B’.”

NOTE: DSP Bank “B” presets are only accessible when the footswitch is connected to the amplifier. When the footswitch is not connected, only DSP Bank “A” is accessible.

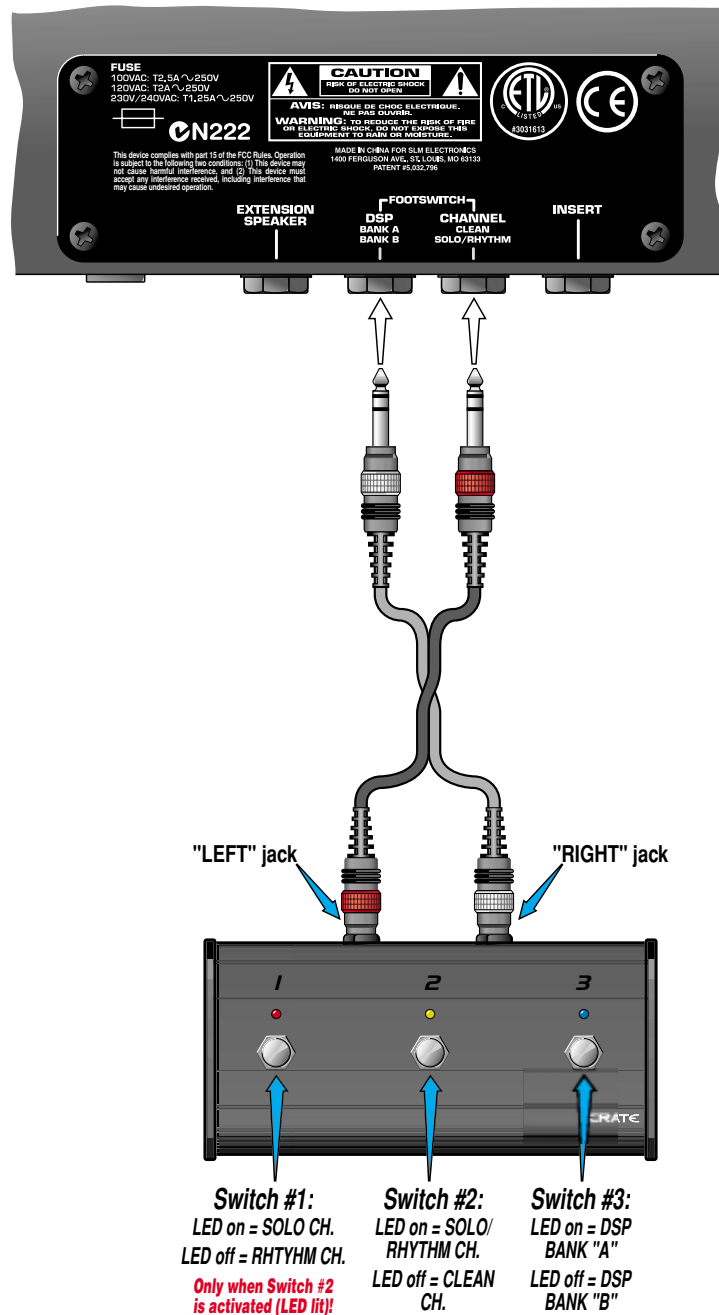

DSP Factory Presets:

The VTX65 Factory Presets for the DSP section are as follows:

Factory Preset 1: Clean w/Chorus, Delay, Reverb

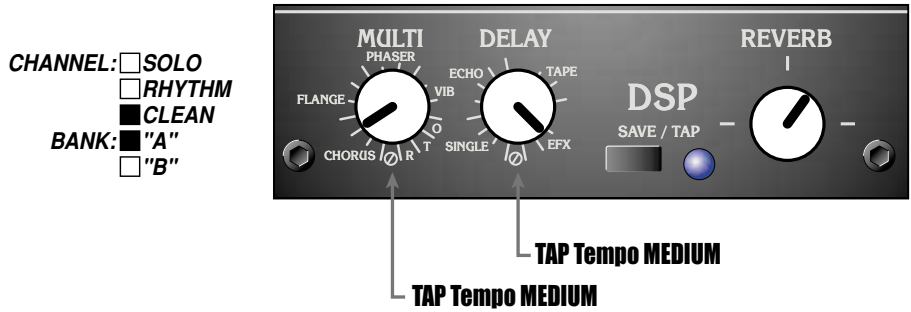

Factory Preset 2: Rhythm w/Slapback Delay

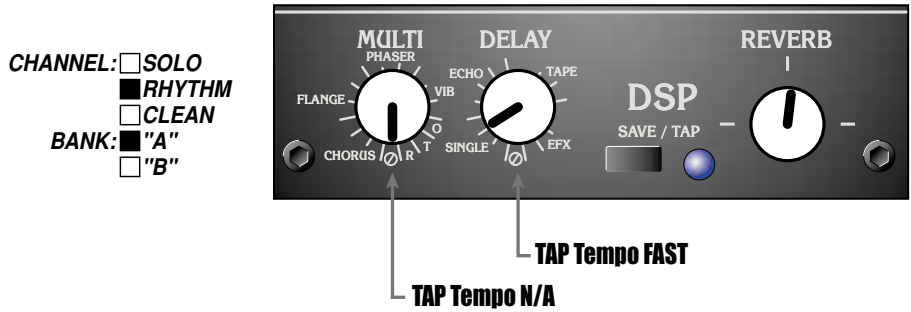

Factory Preset 3: Solo w/Flange, Delay, Reverb

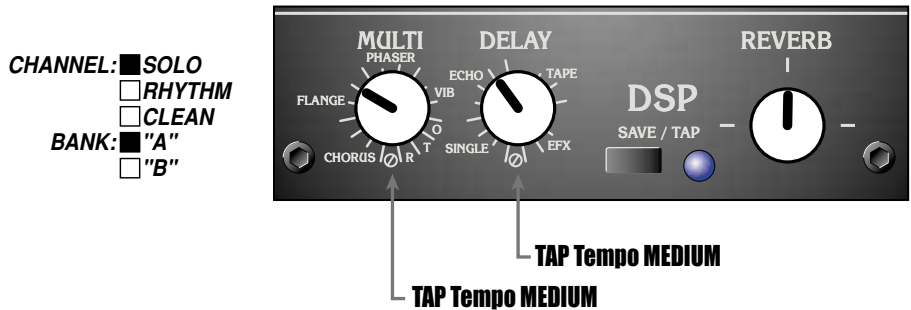

CRATE VTX65 Three-Channel Guitar Amplifier with Advanced DSP

DSP Factory Presets:

The VTX65 Factory Presets for the DSP section are as follows:

Factory Preset 4: Clean w/Reverb

- CHANNEL: SOLO
 RHYTHM
 CLEAN
 BANK: "A"
 "B"

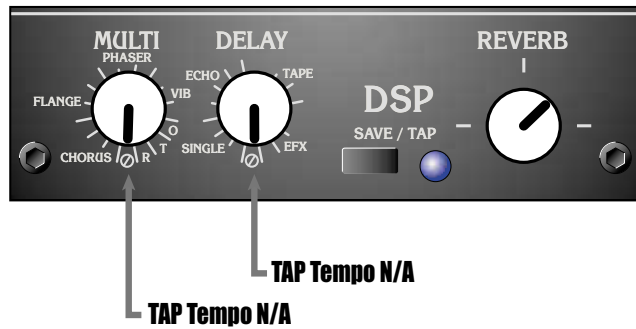

Factory Preset 5: Rhythm w/Reverb

- CHANNEL: SOLO
 RHYTHM
 CLEAN
 BANK: "A"
 "B"

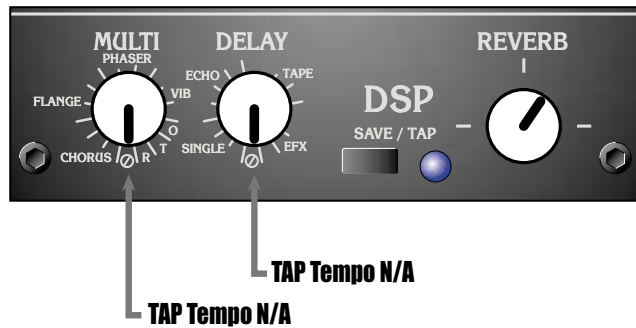

Factory Preset 6: Solo w/Reverb

- CHANNEL: SOLO
 RHYTHM
 CLEAN
 BANK: "A"
 "B"

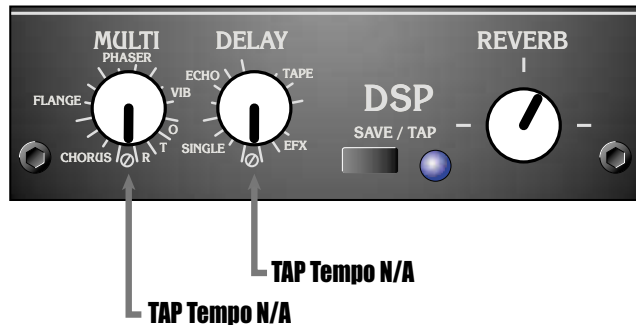

CRATE VTX65 Three-Channel Guitar Amplifier with Advanced DSP

Suggested Settings:

*"Oceanic"
Clean with
Vibrato, Delay,
& Reverb*

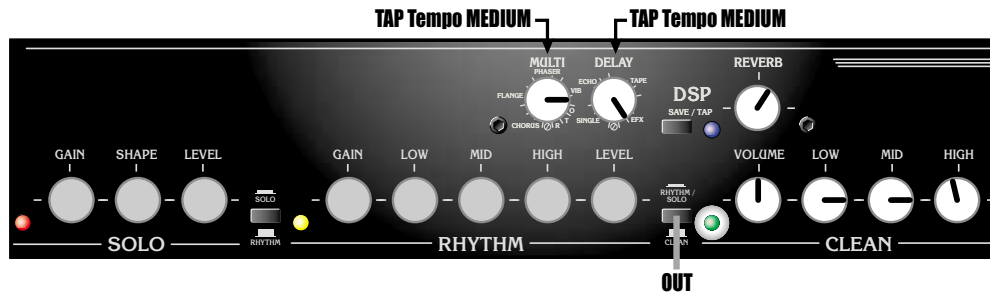

*"Super Funk"
Clean with
Wah, Delay,
& Reverb*

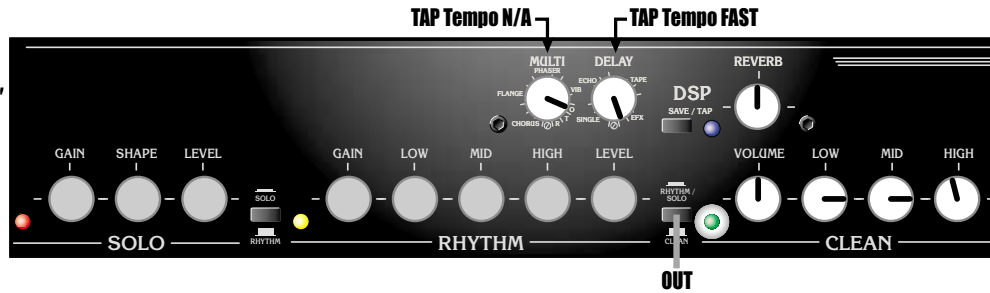

*"Arena"
Rhythm with
Reverb
& Delay*

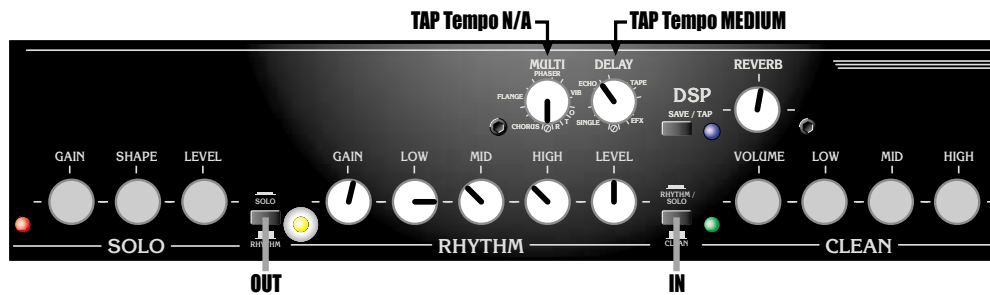

CRATE VTX65 Three-Channel Guitar Amplifier with Advanced DSP

Suggested Settings:

*"Haze Faze"
Rhythm with
Phase
& Reverb*

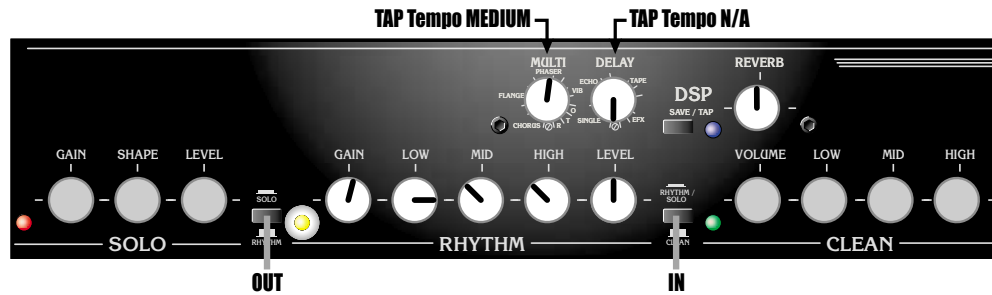

*"Solo Wah"
Solo with
Wah, Delay
& Reverb*



*"Octanator"
Solo with
Octave
& Reverb*



CRATE VTX65 Three-Channel Guitar Amplifier with Advanced DSP

DSP "Fill in the Blanks" (User Settings):

Copy this page to fill in your own DSP Presets!

User Preset: _____

- CHANNEL: SOLO
 RHYTHM
 CLEAN
BANK: "A"
 "B"

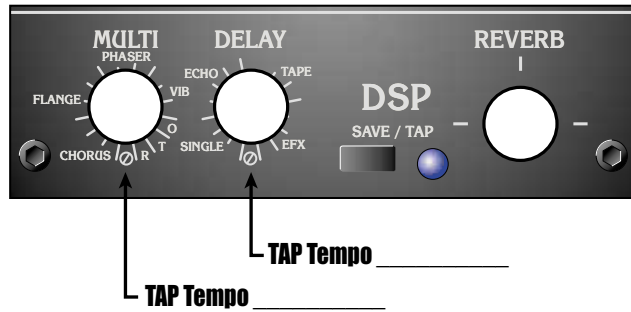

User Preset: _____

- CHANNEL: SOLO
 RHYTHM
 CLEAN
BANK: "A"
 "B"

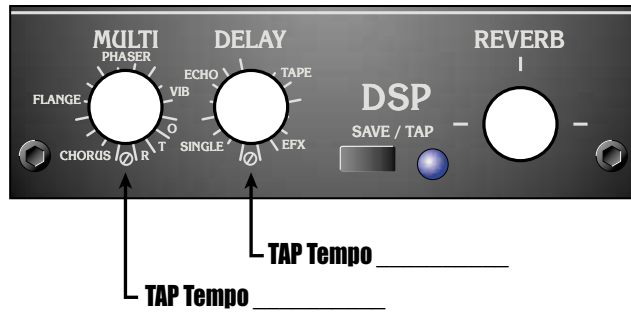

User Preset: _____

- CHANNEL: SOLO
 RHYTHM
 CLEAN
BANK: "A"
 "B"

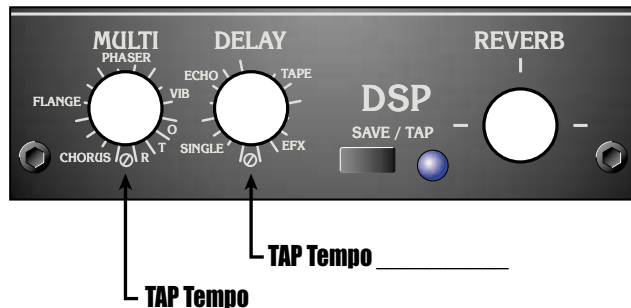

System Block Diagram:

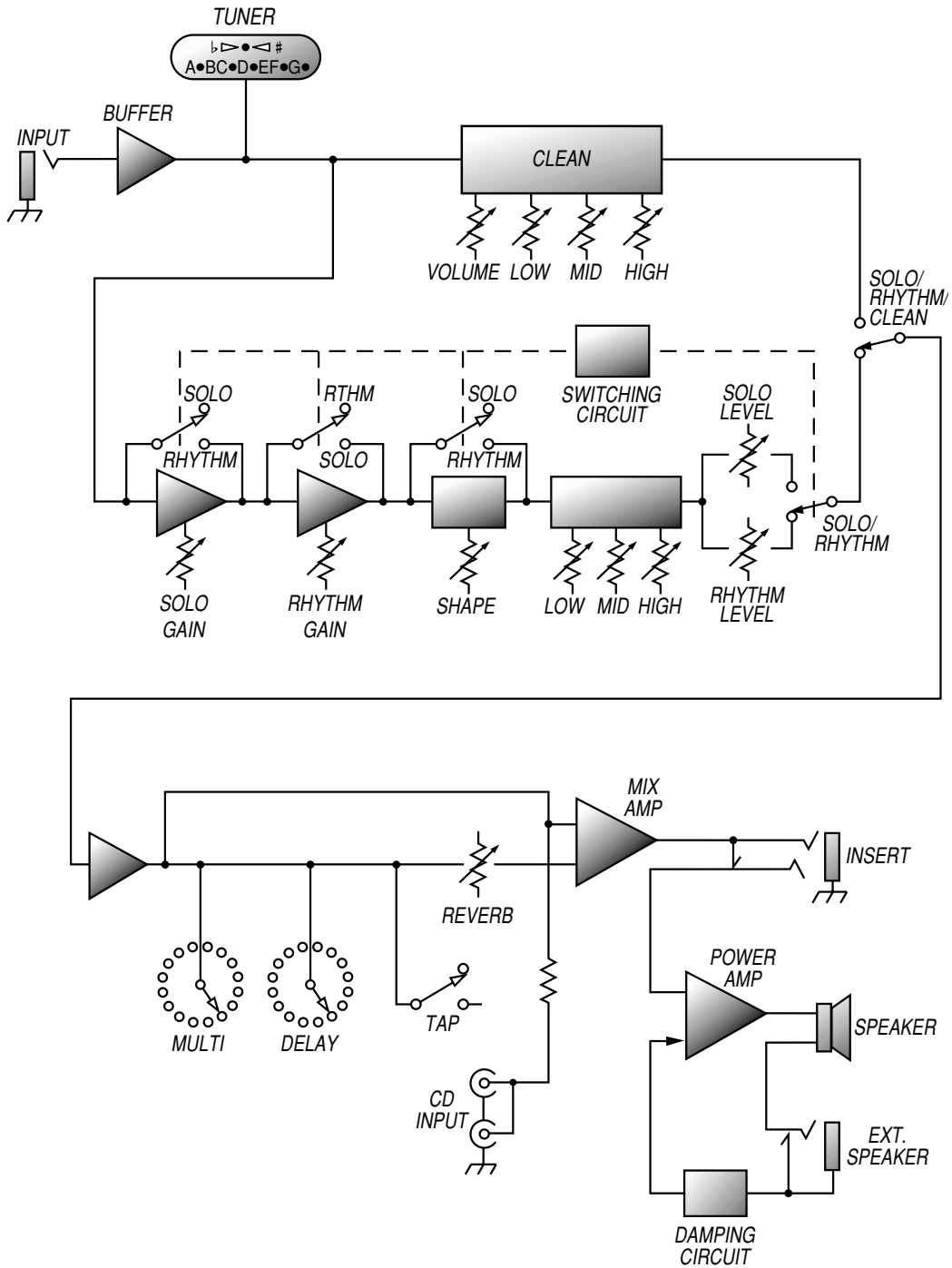

CRATE VTX65 *Three-Channel Guitar Amplifier with Advanced DSP*

VTX65 TECHNICAL SPECIFICATIONS:

| | | |
|-------------------------------|---------------|--|
| Output Power Rating | | 65W RMS @5% THD, 8Ω, 120 VAC |
| Speaker Size and Rating | | (1) Custom Design 12", 8Ω |
| Input Impedance | | 470kΩ |
| Total System Gain | Solo Ch | 110dB, all controls @10 |
| | Rhythm Ch | 88dB, all controls @10 |
| | Clean Ch | 58dB, all controls @10 |
| CD Input | | 29dB |
| Maximum Input Signal Accepted | | 7 volts peak-to-peak |
| Solo Channel | Shape Control | Proprietary Circuit |
| Rhythm Channel | Low Control | 20dB range @ 80Hz |
| | Mid Control | 15dB range @ 1kHz |
| | High Control | 20dB range @ 10kHz |
| Clean Channel | Low Control | 36dB range @ 80Hz |
| | Mid Control | 15dB range @ 800Hz |
| | High Control | 40dB range @ 10kHz |
| Power Requirements | | 120 VAC, 60Hz, 90VA 100/115VAC, 50/60Hz, 90VA; 230VAC, 50/60Hz, 90VA |
| Size and Weight | | 19-1/4" H x 21" W x 10-1/4" D, 34 lbs. |

The VTX65 is covered with a durable Tolex material: wipe it clean with a lint-free cloth. Never spray cleaning agents onto the cabinet. Avoid abrasive cleansers which would damage the finish.

Crate continually develops new products, as well as improves existing ones. For this reason, the specifications and information in this manual are subject to change without notice.

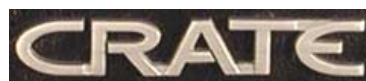

www.crateamps.com

©2004 SLM Electronics, a division of St. Louis Music, Inc • 1400 Ferguson Avenue • St. Louis, MO 63133
47-639-01 • 092104

Free Manuals Download Website

<http://myh66.com>

<http://usermanuals.us>

<http://www.somanuals.com>

<http://www.4manuals.cc>

<http://www.manual-lib.com>

<http://www.404manual.com>

<http://www.luxmanual.com>

<http://aubethermostatmanual.com>

Golf course search by state

<http://golfingnear.com>

Email search by domain

<http://emailbydomain.com>

Auto manuals search

<http://auto.somanuals.com>

TV manuals search

<http://tv.somanuals.com>