

This appliance conforms to the following EEC Directives:

Gas Appliances
90/396/EEC



THIS APPLIANCE MUST BE INSTALLED IN ACCORDANCE WITH THE RULES IN FORCE, AND USED ONLY IN A SUFFICIENTLY VENTILATED SPACE. CONSULT INSTRUCTIONS BEFORE INSTALLATION AND USE OF THIS APPLIANCE.

Creda

Chatsworth

Model Nos. 41301 (Brown)
41302 (Green)

User's & Installation Instructions

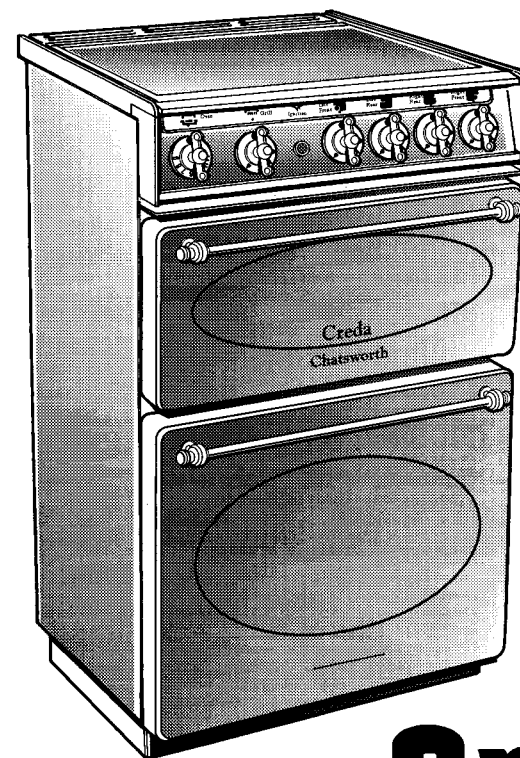

Creda

Creda

Read these instructions prior to using the cooker and retain them for future reference.

The data badge is located on the rear of the cooker.

A serial number is located behind the left-hand side of the oven door seal.

CONTACT US ON THE NET AT <http://www.creda.co.uk>

[Help Me!](#) [Product Selector](#) [Product Browse](#) [News](#) [Tonight's Dinner](#) [Where to Buy](#) [Bubbling Away](#) [Home](#)

Creda

At HOME



with Creda

Creda is the U.K. market leader in domestic drying, cooking and heating products. We welcome you to our site, inviting you to make use of our **interactive cookbook** and product **selector**. Feel free to **browse** our product range, to see what's **bubbling away** at the moment, or to **ask for help** on our products and services.

We also offer an entire **table of contents**, or alternatively, search the site by keywords...

Search

Contents

Introduction	4
Installation Instructions	5
For Your Safety	10
User's Instructions	12
Hotplate	13
Grill	14
Oven	15
Oven Cooking Chart	17
Care and Cleaning	19
Spares and Service	21

Introduction



To help you make the best use of your cooker, PLEASE READ THIS BOOKLET CAREFULLY.



Your new cooker is guaranteed and will give lasting service. The guarantee is only applicable if the cooker has been installed in accordance with the Installation Instructions.

The cooker is designed specifically for domestic use and responsibility will not be accepted for use in any other installation.

When the cooker is first used, a slight odour may be emitted – this should cease after a short period of use.

REPLACING A BATTERY

The battery holder is located in the plinth panel. Using a coin or screwdriver, turn battery cover anticlockwise a quarter of a turn and remove. Insert / replace battery with the end marked + facing outward. Replace cover and turn clockwise a quarter of a turn to secure.

Use an EVER READY R6S or equivalent battery.

Check Points

IGNITION FAILURE

If all burners fail to ignite, check that sparks appear at the burners; a clicking noise should be heard. If not, check/replace battery.

If only a hotplate burner is failing to light, check that:

- the burner cap and air ring are seated correctly.
- the holes in the burner ring are not blocked.

Spares & Service

If there is still a problem with your cooker, contact your nearest service centre; refer to the Creda Guarantee, Service and Spares Information Card for details.

Please have the following information available.

- Model/Number – Creda Chatsworth
Brown Model – 41301
Green Model – 41302

- Serial Number – For your convenience enter the cooker serial number in the box below:

The serial number is located behind the left-hand side of the oven door seal.

Ensure that only authorised Creda replacements are fitted to give the correct performance and appearance.

Repairs carried out by unauthorised or inexperienced persons may cause serious damage to the cooker, and may result in personal injury. Maintenance must be carried out by a competent person.

DISPOSAL OF COOKER

To minimise the risk of injury to children, please dispose of your cooker safely.

Care and Cleaning

Glass Lid	As for enamel cleaning. Polish with a clean dry cloth or kitchen roll.
Chromium Plating Oven shelves, grill pan grid, grill pan handle support	Wipe with a cloth wrung out in hot soapy water. A fine steel wool soap pad e.g. Brillo or a chrome or stainless steel cleaner may be used.
Plastic Grill pan handle	Wipe with a cloth wrung out in hot soapy water. Stubborn stains can be removed with a cream cleaner.
Brass Finish Door handles, control knobs.	Under no circumstances should abrasive cleaning materials be used. To clean, wipe over with a soft cloth wrung out in clean hot water, dry with a soft clean cloth.

Installation

This cooker is set to burn NATURAL GAS ONLY and cannot be used on any other gas.

GAS SAFETY (INSTALLATION & USE) REGULATIONS

It is the law that all gas appliances are installed by competent persons in accordance with the above regulations. It is in your interest and that of safety to ensure compliance with the law.

In the UK, CORGI registered installers work to safe standards of practice.

The cooker must also be installed in accordance with BS 6172: 1990.

Failure to install the cooker correctly could invalidate the warranty liability claims and could lead to prosecution.

Location

The cooker may be located in a kitchen, kitchen/diner or a bed-sitting room, but not in a room containing a bath or shower. The cooker must not be installed in a bed-sitting room of less than 20m³.

Provision for Ventilation

The room containing the cooker should have an air supply in accordance with BS 5440: Part 2: 1989.

The room must have an openable window or equivalent; some rooms may also require a permanent vent. If the room has a volume between 5 and 10m³, it will require an air vent of 50cm² effective area unless it has a door which opens directly to outside. If the room has a volume of less than 5m³, it will require an air vent of 100cm² effective area. If there are other fuel burning appliances in the same room, BS 5440: Part 2: 1989 should be consulted to determine air vent requirements.

Technical Data

Dimensions	Height	900 - 915mm
	Width	538mm
	Depth	600mm (excluding door handles)
General	Gas connection	Rp 1/2 (1/2" BSP female)
	Supply pressure	20mbar
	Pressure test point	Grill injector
	Gas rate adjustment	None
	Aeration adjustment	None
	Battery	1.5V Ever Ready R6S or equivalent
Hotplate	Heat input/injector	Front left & rear right: 2.95kW/145 Front right & rear left: 1.65kW/105
	Spark gap	Front left & rear right: 1.2 - 2.3mm Front right & rear left: 1.4 - 2.5mm
Grill	Heat input/injector	3.65kW/150
	Spark gap	3 - 4mm
Oven	Heat input/injector	2.75kW/120
	Spark gap	3 - 4mm

Care and Cleaning

Clean the cooker regularly and wipe up spills soon after they occur to prevent them from becoming burnt on. Never use biological washing powder, caustic cleaners, harsh abrasives, scouring pads, aerosol cleaners or oven chemical cleaners of any kind.

To move the cooker forward, open the grill door and with both hands positioned under the roof of the compartment lift and pull forward. Replace by pushing the cooker backwards. Check that the cooker is level. Take care to ensure that any floor covering is not damaged.

OVEN HEAT CLEAN LININGS

The oven back and side linings are coated with a special enamel which has a continuous cleaning action. The higher the oven temperature the more effective the action. In most cases this cleaning operation will proceed during normal cooking. However, if high temperatures are not used regularly, it may be necessary to run the oven empty at Mark 8 for a couple of hours. If desired, they can be washed with warm soapy water followed by a rinse.

COOKER FINISH

Vitreous Enamel

Hotplate, control fascia, pan supports, burner ring discs, roasting tin, grill pan, oven base, inside/outside of oven and grill door, grill compartment.

Paint

Plinth, lid trim, fascia trim.

Aluminium

Hotplate side trims, burner port rings, burner bodies.

CLEANING METHOD

Cloth wrung out in hot soapy water. Stubborn stains can be removed with a cream, paste, liquid cleaner or by rubbing with fine wool soap pads, eg. Brillo. Check that the cleaning agent is approved by Vitreous Enamel Development Council.

Wash with a cloth wrung out in hot soapy water only.
DO NOT USE ABRASIVES.

Similar to enamel cleaning above. Use a nylon brush to remove any cleaning materials, water or dirt from the burner port rings.

Oven Cooking Chart

Food	Gas Mark	Shelf Positions	Approx. Cooking Time and Comments
CAKES, PASTRIES AND BISCUITS			
Small cakes - 2 trays	5	2 & 4	17 - 25 mins
- 1 tray	5	2 or 3 only	"
Victoria sandwich 2x8" (205mm)	4	2 & 4	25 - 35 mins
Fatless sponge 2x7" (180mm) - 3 egg mix	5	2	20 - 25 mins. 2 tins side by side
Christmas cake	2	3 or 4	4 - 6½ hrs depending on recipe
Madeira cake 7" (180mm)	4	3	1¼ - 1½ hrs
Rich Fruit cake 9" (230mm)	2	3	3 - 3½ hrs.
Shortcrust pastry	6	2 or 3	15 mins - 1 hr depending on recipe
Rich Shortcrust pastry - 1 tray	5	2	20 - 40 mins depending on recipe
Flaky & puff pastry - 2 trays	7	1 & 3	10 - 30 mins depending on recipe
- 1 tray		2 or 3	" " " "
Choux pastry - éclairs 1 tray	6	2	35 - 40 mins
Scones - 2 trays	7	2 & 4	10 - 15 mins
- 1 tray		2 or 3	"
Shortbread - 7" (180mm) round	2	4	55 - 1hr depending on thickness
Biscuits - 2 trays	4	1 and 3	15 - 20 mins depending on recipe
- 1 tray		2 or 3	" " " "
YEAST MIXTURES			
Bread	7 or 8	3 or 4	45 - 50 mins
Rolls	7 or 8	2 or 3	15 - 20 mins
Chelsea buns	5	2 or 3	30 - 40 mins
MISCELLANEOUS			
Yorkshire Pudding - large	7	1 or 2	45 - 50 mins
- individual	7	1 or 2	25 - 30 mins
Soufflés	4	3	30 mins
Meringues	'E'	4 & baseplate	2 - 5 hrs starting on shelf 4 until 'set' and then on the baseplate until dried out - turn when necessary.
Baked Potatoes	4 or 5	3	1½ - 3 hrs until soft, depending on size

When baking with two trays or tins on two levels, the top tray is removed first and the lower tray moved up to the top position for a few minutes longer.

Soft Margarine - Use the oven settings recommended by the margarine manufacturer and **not** those indicated on the cooking chart.

Space For Fixing

The cooker can be close fitted below hotplate level. This requires a minimum distance of 540mm between cupboard units of hotplate height.

The wall behind the cooker between the hotplate and 450mm above, and the width of the cooker, must be a non-combustible material such as ceramic wall tiles.

Follow the diagrams below for guidance on fitting. Take note of all dimensions.

**Fig. 1
INSTALLATION WITH WALL
CUPBOARDS IN LINE WITH
SIDES OF APPLIANCE**

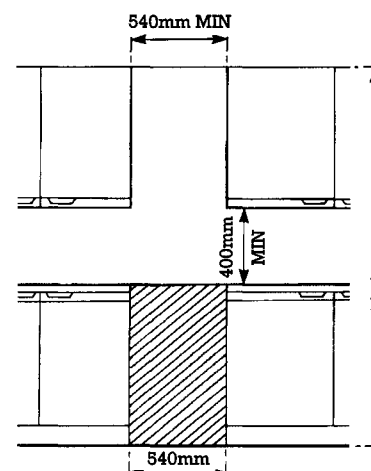

**Fig. 3
INSTALLATION USING BRIDGING
CUPBOARDS**

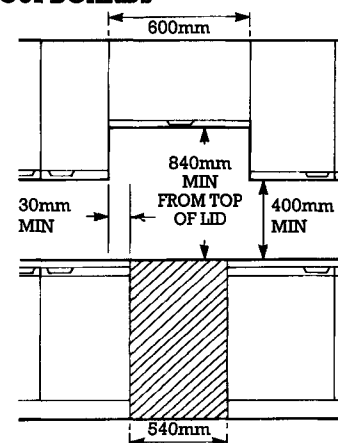

**Fig. 2
INSTALLATION ALONGSIDE
TALL CUPBOARDS OR SIDEWALL**

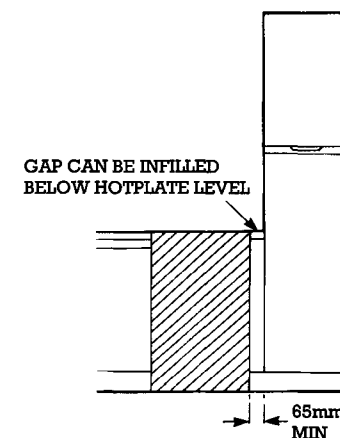

**Fig. 4
INSTALLATION CLOSE TO A
CORNER**

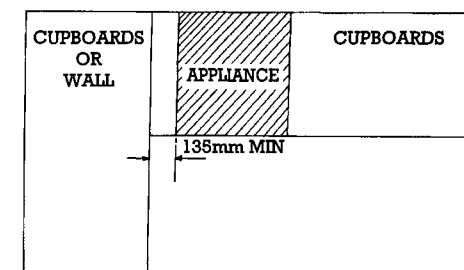

If your appliance is to be fitted close to a corner on the left hand side ensure that there is a clearance of 135mm minimum.

This will enable you to fully open the door and allow removal of oven shelves.

Unpacking The Cooker

Unpack the components from inside the grill and oven: Check that the following parts are present.

Grill pan and grid	Enamelled discs (4)
Meat tin	Burner port rings (4)
2 Oven shelves	Literature pack
Pan supports (4)	

Levelling

Four skid feet are fitted which can be screwed in or out to level the cooker. Move the cooker by pushing at both sides on the lower half of the oven door.

Caution: Some soft floor coverings may get damaged if the cooker is not moved carefully.

Stability Bracket

The cooker must be fitted with a stability device firmly secured to the fabric of the building. The back of the cooker has a slot for engagement of a stability bracket, which can be obtained, as an extra, from the cooker supplier. The leaflet included with the bracket should be read in conjunction with the following instructions.

Push cooker to its intended position.

Draw pencil lines on the floor in line with the front and left side of the plinth.

Remove the cooker.

Position stability bracket in accordance with Fig. 5 and secure to the floor.

Measure height from floor level to the bottom of the slot in the back of the cooker.

Add 3mm to the dimension and assemble the stability bracket to that height. (i.e. from floor level to the underside of the top member)

Fig. 5

Fig. 6

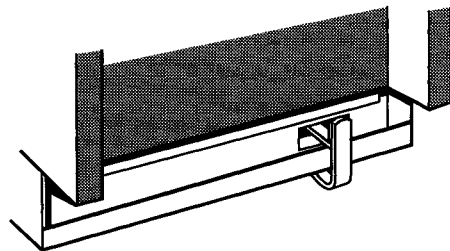
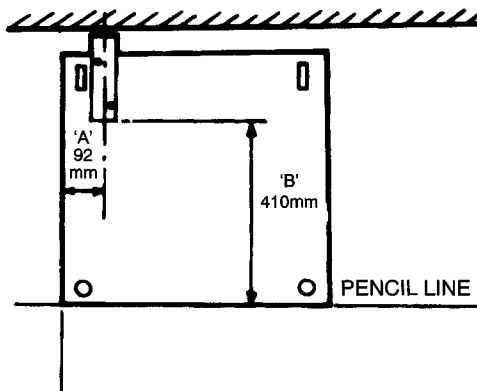

Oven Cooking Chart

The following times and setting are for guidance only. You may wish to alter the setting to give a result more to your satisfaction. When a different setting to that shown below is given in a recipe, the recipe instructions should be followed. Allow 15 minutes preheat for best results. Always turn the thermostat knob to Mark 9 before selecting the appropriate Gas Mark. Shelf position 1 is the highest.

Food	Gas Mark	Shelf Positions	Approx. Cooking Time and Comments
STARTERS			
Patés and Terrines	3 or 4	4	1½ - 2 hrs
FISH			
Oily Fish (whole)	4 or 5	3	25 mins - 1 hr, depending on recipe and size of fish
White Fish (fillets & steaks)	4 or 5	3	25 - 30 mins.
MEAT AND POULTRY			
Veal	5	4	25 mins per lb + 25 mins
Beef	4 or 5	4	25 - 30 mins per lb + 25 mins
Ham	5	4	40 mins per lb covered in foil + 40 mins per lb uncovered
Lamb	5	4	30 - 35 mins per lb + 30 mins
Pork	5	4	40 mins per lb + 40 mins
Chicken	5	4	25 mins per lb + 25 mins
Duckling & gosling	5	4	25 mins per lb + 25 mins
Turkey	4 or 5	4 or 5	15 - 20 mins per lb + 20 mins
Game birds	6	4	80 mins. Remove bacon for last 15 mins. Add extra 15 mins if roasting brace
Casseroles	3	3 or 4	1½ - 6 hrs. (depending on type of meat)
PUDDINGS			
Milk Puddings	3	3 or 4	2¼ - 2½ hrs on a baking tray and started with warm milk
Baked Custard	3	3 or 4	45 mins in bain-marie
Baked sponges	4	3	40 - 50 mins
Baked Apples	3	4	30 - 45 mins depending on the size and type of apples
Meringue puddings	1	4 or 5	15 mins or until 'tinged' with brown
Apple Pie 1x9" (230mm)	6	3	45 - 55 mins on a baking tray
Fruit crumbles	5 or 6	3	35 - 45 mins

If using aluminium foil:

1. Remember it is important to increase the cooking time by one third.
2. Never allow the foil to touch the sides of the oven.
3. Never cover the oven interior with foil.
4. Never cover the oven shelves with foil.

The 'E' Setting

Using the 'E' Setting for Slow Cooking

This is used for slow cooking, keeping food warm and warming plates for short periods.

1. All dishes cooked by the 'E' setting should be cooked for a minimum of 6 hours. They will 'hold' at this setting for a further hour but marked deterioration in appearance will be noticed in some cases, beyond this time.
2. Joints of meat and poultry should be cooked at Mk. 6 for 30 mins. before turning to the 'E' setting and never be cooked lower than the middle shelf position.
3. Joints of meat over 6lbs (2.7kg) and poultry over 4lbs 8oz (2kg) should not be cooked using the 'E' setting.
4. Always stand covered joints on a rack over the meat tin, to allow good air circulation.
5. Pork joints and poultry must be checked for an internal temperature of at least 88°C using a meat thermometer.

Storage and Re-heating of Food

It is vitally important to strictly adhere to the basic principles of food handling and hygiene to prevent the possibility of pathogenic bacterial growth.

1. If food is to be frozen or not served immediately, cool it in a clean container as quickly as possible.
2. Completely thaw frozen food in the refrigerator before re-heating.
3. Re-heat food thoroughly and quickly either on the hotplate or in a hot oven, gas Mk. 6, and then serve immediately.
4. Only re-heat food once.

'Cook Chill' Dishes

These should always be placed in a pre-heated oven ideally on the first or second shelf position. Follow the packet instructions for cooking time.

Connecting To Gas Supply

The cooker is designed to match the depth of standard 600mm worktops. An adaptor backplate (Fig. 7) should, therefore, be fitted within the shaded area shown in Fig. 8 to allow the cooker to be pushed fully to the wall. If a forward facing backplate is used, it must be chased into the wall.

Fig. 7

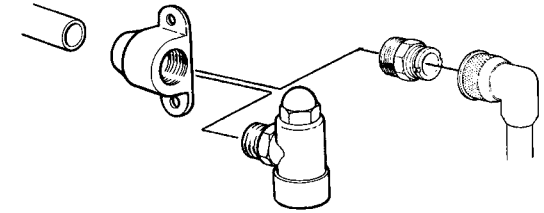
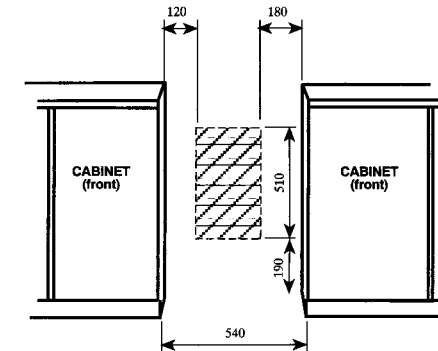

Fig. 8



Connection to the cooker should be made with an approved appliance flexible connection to BS 669. A length of 0.9 to 1.25m is recommended. The length of hose chosen should be such that when the cooker is in situ, the hose does not touch the floor.

The temperature rise of areas at the rear of the cooker that are likely to come in contact with the flexible hose do not exceed 70°C.

After installation, check for soundness.

The supply pressure can be checked at the grill injector. Access to the injector is by first removing the baffle at the front of the compartment and then the burner.

For Your Safety

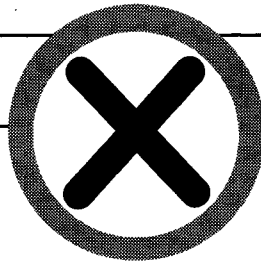

Never

- Never leave children unsupervised where the cooker is installed as all surfaces will get hot during and after use.
- Never allow anyone to sit or stand on any part of the cooker.
- Never store items that children may attempt to reach above the cooker.
- Never heat up unopened food containers as pressure can build up causing the container to burst.
- Never store chemicals, food stuffs, pressurised container in or on the cooker, or in cabinets immediately above or next to the cooker.
- Never fill a deep fat frying pan more than 1/3 full of oil, or use a lid. **DO NOT LEAVE UNATTENDED WHILE COOKING.**
- Never place flammable or plastic items on or near the hotplate.
- Never fill chip pans more than one third full with oil or fat.
- Never use proprietary spillage collectors on the hotplate.
- Never use the cooker as a room heater.
- Never dry clothes or place other items over or near to the hotplate or oven/grill doors.
- Never wear garments with long flowing sleeves whilst cooking.

Safety Advice

In the event of a chip pan fire or any other pan fire.

1. **TURN OFF ALL THE BURNERS.**
2. **COVER THE PAN WITH A FIRE BLANKET OR DAMP CLOTH,** this will smother the flames and extinguish the fire.
3. **LEAVE THE PAN TO COOL FOR AT LEAST 60 MINUTES BEFORE MOVING IT.** Injuries are often caused by picking up a hot pan and rushing outside with it.

NEVER USE A FIRE EXTINGUISHER TO PUT OUT A PAN FIRE as the force of the extinguisher is likely to tip the pan over.
Never use water to extinguish oil or fat fires.

Oven

The oven has different heat zones – the thermostat settings refer to the temperature on the middle shelf; above this shelf it is hotter and below it is cooler. Two straight shelves provide six possible cooking levels enabling full use of the different temperatures inside the oven.

Shelves are removed from the oven by pulling them out to the stop and then lifting them at the front to withdraw.

A meat tin is provided with the cooker.

To Use The Oven

1. Check that the battery is in position.
2. Place oven shelves in the appropriate positions (refer to cooking charts).
3. Push in and turn the oven control knob fully anti-clockwise. Press the ignition button until the sparks light the gas.
4. Turn the control knob clockwise to the required setting (refer to cooking chart). There is a delay of about one minute whilst the safety device operates before the burner comes on full.
5. To turn off, turn the control knob fully clockwise to the symbol ●.

An odour may be noticed when first using the oven. This is due to newness and will soon disperse.
Never place dishes on the oven base over the burner.

Cold Start Cooking

Anything requiring long slow cooking such as Casseroles and rich fruit cakes can be put into a cold oven. Satisfactory results can also be obtained with creamed mixture, rich pastries or yeast mixtures, but for perfection we recommend preheating the oven for about 15 minutes.

Preparation and Roasting of Large Poultry





It is important to check that the bird and foil **DO NOT** overhang the burner at the back of the oven.

The maximum weight of turkey that can be accommodated is 25lbs (11.5kg) provided it is of suitable shape.

Grill

CAUTION – ACCESSIBLE PARTS MAY BECOME HOT WHEN THE GRILL IS USED. YOUNG CHILDREN SHOULD BE KEPT AWAY.

To Use The Grill



1. Check that the battery is in position.
2. Open the grill door and remove the grill pan.
3. Push in and turn the control knob anti-clockwise to the large flame symbol . Press the ignition button until the spark lights the gas.
4. Turn the control knob anti-clockwise to the desired setting. Only turn the control knob between the large flame symbol  and the small flame symbol  when adjusting the setting.
5. To turn off, turn the control knob fully clockwise to the symbol .

Slide the grill pan along the chosen runner towards the rear of the grill compartment until it touches the stops.

An odour may be noticed when first using the grill. This is due to the newness and will soon disperse.

DO NOT use the grill with the door closed.
DO NOT cover the grill pan or grid with aluminium foil as this can hold fat, intensify the heat and create a fire hazard.

The following chart is a guide. Grilling can be started from cold but for best results preheat for approximately two minutes.

Grill Setting	Runner Position	Food
	High	Toast, crumpets, bacon, thin sausages, beefburgers, kidneys, fish fingers, fillet steak, tomatoes, toasted snacks.
	Low	Thick sausages, rump & sirloin steak, fish fillets, fish steaks, small whole fish.
	Low	Chicken portions, chops, large whole fish.

For au gratin dishes eg. Macaroni Cheese and meringue toppings eg. Baked Alaska, place the dish on the floor of the grill compartment. The base of the grill pan can be used for warming fruit garnishes on the reduced setting.

NOTE: Strong detergents used in dishwashers may damage the grill pan grid finish; clean in soapy water as described in CARE AND CLEANING section.

Always ensure that the grill pan handle is securely fastened to the grill pan handle. If necessary tighten any loose screws with a screwdriver.

For Your Safety

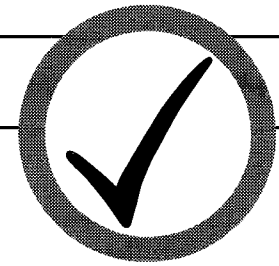

PLEASE READ THE PRECAUTIONS BELOW BEFORE USING YOUR APPLIANCE.

Always

- Always make sure you understand the controls before using the cooker.
- Always keep children away from the cooker when grilling as the surfaces will get extremely hot during and after use.
- Always check that all controls on the cooker are turned off after use.
- Always stand back when opening an oven door to allow heat to disperse.
- Always keep the oven and grill doors closed when the cooker is **not** in use.
- Always place pans centrally over the hotplate burners and position them so that the handles cannot accidentally be caught or knocked or become heated by other burners.
- Always keep the cooker clean, as a build up of grease or fat from cooking can cause a fire.
- Always allow the cooker to cool before cleaning.
- Always follow the basic principles of food handling and hygiene to prevent the possibility of bacterial growth.
- Always keep ventilation slots clear of obstructions.
- Always refer servicing to CORGI registered appliance service engineers.

User's Instructions

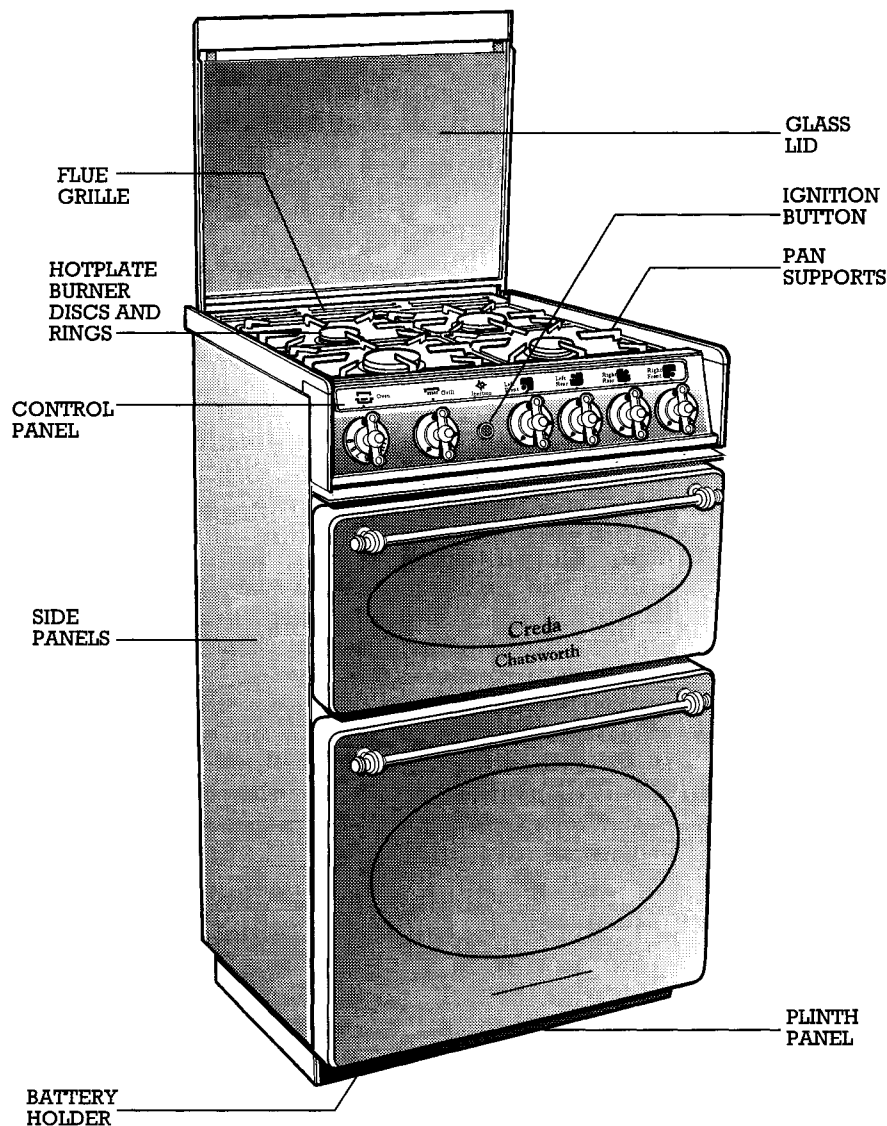





Hotplate

The hotplate lid is fitted with a safety device which cuts off the gas supply to the hotplate burners unless the lid is fully open. Do not use the safety device as a means of controlling the hotplate burners.

The hotplate has two high speed burners and two simmering burners which will accommodate pans between 100mm (4") and 230mm (9") diameter. All pans should be positioned centrally over the burners.

Simmering aids such as steel plates should not be used because they can cause damage to the pan supports.

To Use the Hotplate

1. Check that the battery is in position.
2. Push in and turn the control knob of the chosen burner anti-clockwise to the large flame symbol . Press the ignition button until the spark lights the gas.
3. Turn the control knob anti-clockwise to the desired setting. Only turn the control knob between the large flame symbol  and the small flame symbol  for adjusting the setting.
4. To turn off, turn the control knob fully clockwise to the symbol .

DO NOT use mis-shapen pans which may be unstable.
DO NOT use round base woks directly on the pan supports.
DO NOT use the glass lid as a working surface.

Safety Requirements for Deep Fat Frying

1. Never fill chip pans more than one third full with oil or fat.
2. Never leave oil or fat unattended during the heating or cooling period.
3. Never heat fat or fry with a lid on the pan.
4. Always dry food thoroughly before frying, and lower it slowly into the hot oil or fat. Frozen foods in particular will cause frothing and spitting if added too quickly.
5. Always keep the outside of the pan clean and free from streaks of oil or fat.

How to Deal with a Fat Fire

1. Do not move the pan.
2. Turn off the hotplate burners.
3. Smother the flames with a fire blanket or damp cloth to extinguish the fire. Do not use water or a fire extinguisher as the force of it may spread the burning fat or oil over the edge of the pan.
4. Leave the pan for at least 60 minutes before moving it.

Free Manuals Download Website

<http://myh66.com>

<http://usermanuals.us>

<http://www.somanuals.com>

<http://www.4manuals.cc>

<http://www.manual-lib.com>

<http://www.404manual.com>

<http://www.luxmanual.com>

<http://aubethermostatmanual.com>

Golf course search by state

<http://golfingnear.com>

Email search by domain

<http://emailbydomain.com>

Auto manuals search

<http://auto.somanuals.com>

TV manuals search

<http://tv.somanuals.com>