

# **Creda**

## **E010E / R010E**

# **Installation & User Instructions**

**You must read these instructions prior to using the appliance and retain them for future reference.**



For more information on our exciting product range ring  
**Creda Answer Centre 08701 54 64 74**

OR



Visit us on the **NET** at  
**<http://www.creda.co.uk>**

Our site invites you to make use of our **interactive cookbook** and **product selector**. Feel free to **browse our product range** to see what's **bubbling away** at the moment or to **ask for help** on our products and services

# Creda

General Domestic Appliances Ltd. Morley Way Peterborough PE2 9JB  
**Creda Answer Centre** 08701 54 64 74  
**Web** <http://www.creda.co.uk>

It may be necessary from time to time to change the specification outlined in this booklet without notice. Any change which is made will not affect your statutory rights.

---

# Contents

---

Introduction	4
Safety Information	5
Features	7
Controls	8
Oven Timer Operation	9
Solarplus Grill	15
Grill Pan and Handle	16
Grilling Procedure	17
Grill Chart	18
Using the Oven for Fan Cooking	19
Using the Oven for Other Functions	21
Temperature Conversion Chart	22
Oven Temperature Charts	23
Cooking Results Not Satisfactory?	25
Care and Cleaning	26
Installation	30
Something Wrong?	35
Key Contacts	Back Cover

---

# Introduction

---

Your new appliance is guaranteed\* and will give lasting service. This guarantee is only applicable if the appliance has been installed in accordance with the installation instructions detailed in this booklet.

To help make best use of your cooking equipment, please read this booklet carefully.

The cooker is designed specifically for domestic use and responsibility will not be accepted for use in any other installation.

**When the cooker is first used an odour may be emitted,  
this will cease after a period of use**

When first using the cooker ensure that the room is well ventilated (e.g. open a window or use an extractor fan) and that persons who may be sensitive to the odour avoid any fumes. It is suggested that any pets be removed from the room until the smell has ceased. This odour is due to temporary finish on oven liners and elements and also any moisture absorbed by the insulation.

**\* The guarantee is subject to the provisions that the appliance:**

- (a) Has been used solely in accordance with the Users Instruction Book.**
- (b) Has been properly connected to a suitable supply voltage as stated on the rating plate attached to this equipment.**
- (c) Has not been subjected to misuse or accident or been modified or repaired by any person other than the authorised employee or agent.**
- (d) Has been correctly installed.**

## Disposal of your product

To minimise the risk of injury to children please dispose of your product carefully and safely. Remove all doors and lids. Remove the mains cable (where fitted) by cutting off flush with the appliance and always ensure that no plug is left in a condition where it could be connected to the electricity supply.

To help the environment, Local Authority instructions should be followed for the disposal of you product.

This appliance conforms to the following EEC Directives:

Electromagnetic Compatibility	Low Voltage Equipment
89/336/EEC	73/23/EEC
92/31/EEC	93/68/EEC
93/68/EEC	



---

# Safety Information

---

**When used properly your appliance is completely safe but as with any electrical product there are certain precautions that must be observed.  
PLEASE READ THE PRECAUTIONS BELOW BEFORE USING YOUR APPLIANCE.**

## Always

- Always make sure you remove all packaging and literature from inside the oven and grill compartments before switching on for the first time.
- Always make sure you understand the controls prior to using the appliance.
- Always keep children away from the appliance when in use as the surfaces will get extremely hot during and after cooking.
- Always make sure all controls are turned off when you have finished cooking and when not in use.
- Always stand back when opening an oven door to allow any build up of steam or heat to disperse.
- Always use dry, good quality oven gloves when removing items from the oven/grill.
- Always take care to avoid heat/steam burns when operating the controls.
- Always turn off the electricity supply at the wall switch before cleaning and allow the appliance to cool.
- Always make sure the shelves are in the correct position before switching on the oven.
- Always keep the oven and grill doors closed when the appliance is not in use.
- Always keep the appliance clean as a build up of grease or fat from cooking can cause a fire.
- Always follow the basic principles of food handling and hygiene to prevent the possibility of bacterial growth.
- Always keep ventilation slots clear of obstructions.
- Always refer servicing to a qualified appliance service engineer.
- During use the oven becomes hot. Care should be taken to avoid touching heating elements inside the oven,

## SAFETY ADVICE

### IN THE EVENT OF A CHIP PAN OR ANY OTHER PAN FIRE:

1. TURN OFF THE COOKER APPLIANCE AT THE WALL SWITCH.
2. COVER THE PAN WITH A FIRE BLANKET OR DAMP CLOTH, this will smother the flames and extinguish the fire.
3. LEAVE THE PAN TO COOL FOR AT LEAST 60 MINUTES BEFORE MOVING IT. Injuries are often caused by picking up a hot pan and rushing outside with it. NEVER USE A FIRE EXTINGUISHER TO PUT OUT A PAN FIRE as the force of the extinguisher is likely to tip the pan over. Never use water to extinguish oil or fat fires.

---

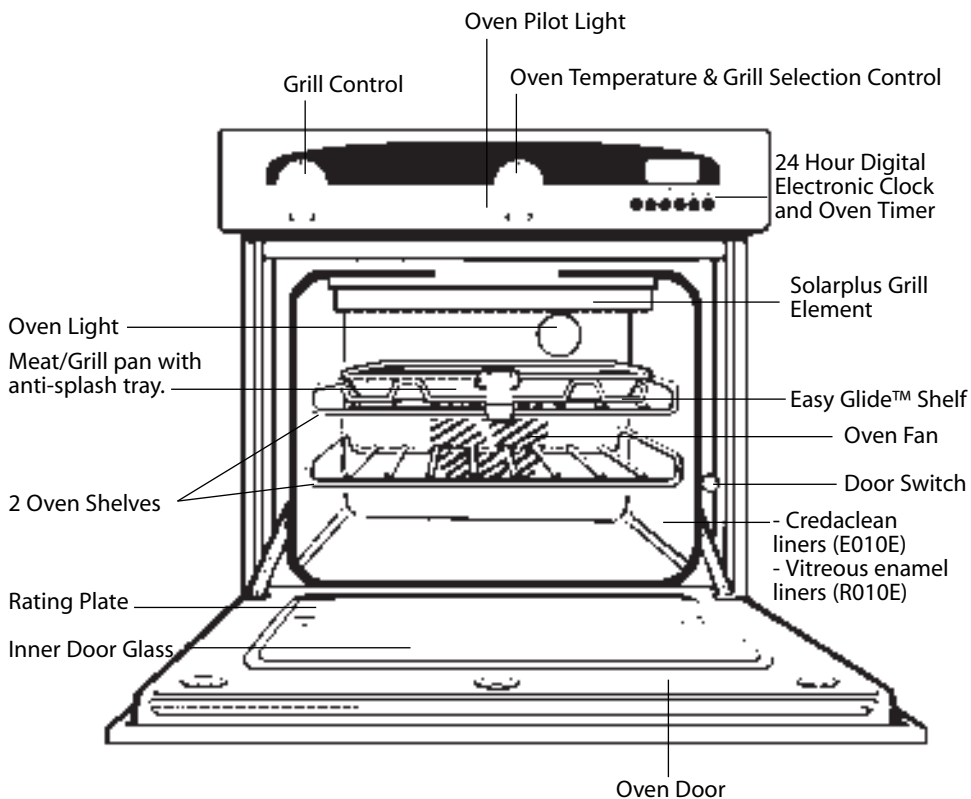
# Safety Information

---

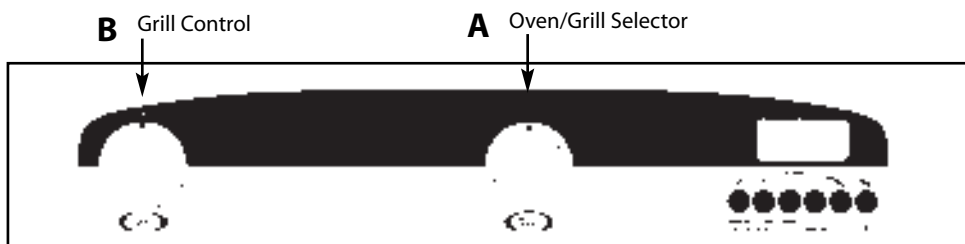
## Never

- Never leave children unsupervised where a cooking appliance is installed as all cooking surfaces will be hot during and after use.
- Never allow anyone to sit or stand on any part of the appliance.
- Never store items above the appliance that children may attempt to reach.
- Never remove the oven shelves whilst the oven is hot.
- Never heat up unopened food containers as pressure can build up causing the container to burst.
- Never store chemicals, food stuffs or pressurised containers in or on the appliance, or in cabinets immediately above or next to the appliance.
- Never operate the grill with the door closed as this will cause the appliance to overheat.
- Never use the appliance as a room heater.
- Never use the grill to warm plates.
- Never dry any items on the oven doors.
- Never install the appliance next to curtains or other soft furnishings.
- Never allow children to play with the appliance controls.
- Never use 'steam cleaners'.

# Features



# Controls



## Control markings:

Control Knob	Description	Function
A	Oven & Grill Selector	<b>Fan Oven</b> Turning control (A) clockwise allows use of fan oven. When cooking turn to the required setting. The oven temperature scale is in degrees centigrade.
A & B	Oven & Grill Selector & Grill Control 1 = Low 6 = High	<b>Full Grill</b> Turn control (A) clockwise until the full grill symbol is positioned centrally in the control window. Turn control (B) in either direction to the required grill setting.
A & B	Oven & Grill Selector & Grill Control 1 = Low 6 = High	<b>Half Grill</b> Turn control (A) clockwise until the half grill symbol is positioned centrally in the control window. Turn control (B) in either direction to the required grill setting.
Note: Resistance will be felt when turning from fan oven operation to full grill / half grill positions		

**Cooling Fan** A gentle flow of air will be blown below the control panel when the oven or grill is switched on. In some instances this will continue after switching the oven / grill off. This is not unusual. This helps to keep the control panel and knobs cool.

**Oven Interior Lights** The oven light is switched on automatically when the fan oven control (A) is operated..

**Slow Cooking** The oven has a "Slow Cook Setting" this can be used for slow cooking, keeping food warm and / or warming plates for a short period. Turn oven control (A) to 90°C

**Element and Fan cut-off** The oven is fitted with a safety device which disconnects the heating element and oven fan when the door is opened. The heating element and oven fan will not operate until the oven door is closed.

**Note: It is advisable to check that all oven controls have been switched off after you have finished using the appliance.**



---

# Oven Timer Operation

---

The oven timer offers you the following features:

1. Time of Day
2. Automatic Cooking
3. Minute Minder

**Automatic Cooking** The Oven can be controlled by the automatic timer.

## Hints on Automatic Cooking

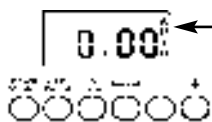
1. Select foods which will take the same time to cook and require approximately the same temperature.
2. Set the oven timer so that the food has just finished or about to finish cooking on your return to the oven. This will ensure the food has not cooled down and does not require reheating before serving.
3. Food should be as cold as possible when it goes into the oven, ideally straight from the refrigerator. Frozen meat and poultry should be thawed thoroughly before it is put in the oven.
4. We advise that warm food should never be placed in the oven if there is to be a delay period. Stews prepared by frying the meat and vegetables should be cooked as soon as possible.
5. We advise dishes containing left-over cooked poultry or meat, for example Shepherds Pie, should not be cooked automatically if there is to be a delay period.
6. Stews and joints should be cooked by the long slow method, so that the delay period is kept to a minimum.
7. On warm days, to prevent harmful bacterial growth in certain foods (ie poultry, joints, etc) the delayed start should be kept to a minimum.
8. Wine or beer may ferment and cream may curdle during the delay period, so it is best to add these ingredients just before serving.
9. Foods which discolour should be protected by coating in fat or tossing in water to which lemon juice has been added, prior to placing food in the oven.
10. Dishes containing liquid should not be filled too full to prevent boiling over.
11. Food should be well sealed (but not airtight) in a container to prevent the loss of liquid during cooking. Aluminium foil gives a good seal.
12. Ensure food is cooked thoroughly before serving.

## Timer Operation

1. Make sure all oven controls are turned **Off**.
2. Check that the electricity supply to the oven is turned **On**.
3. Check that the oven clock is at the right time of day.

# Know Your Timer

## CLOCKFACE



The timer incorporates a 24 hour clock.



**Ensure the correct time of day is always set, before using your cooker.**

**PLEASE NOTE THAT THE DISPLAY WILL DIM BETWEEN 22.00**

**HOURS AND 06.00 HOURS TO PREVENT GLARE.**

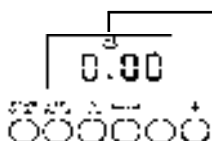
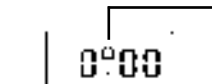
**However, should you operate the timer during these hours the display will return to normal brightness for a few seconds and then dim again.**

## SYMBOLS

 will light up when you select a Minute Minder Period and will remain lit for the period set. At the end of the Minute Minder Period, the timer will emit an audible tone for 2 minutes, the  symbol will start to flash and will continue to flash until the Minute Minder function is cancelled.

 This "Cookpot" symbol will light up either:-

- When you press the Cook Period Button and set a length of time for an Auto Cooking Programme. (It will go out again a few seconds after you release the timer buttons).
- During the actual Cook Period.

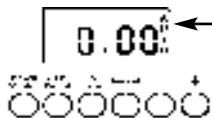


"AUTO" will light up:-

- When the timer is first turned on it will flash. (It will go out when a time of day is set).
- When an Auto Cooking Programme has been set.

The "Auto" symbol will flash at the end of an Auto Cooking programme to indicate that the programme has finished.

**(When the "Auto" symbol is flashing, to return the oven to Manual operation, turn the oven controls off, ensure that the correct time of day is set, and press the "Manual" button twice – The "Auto" symbol will go out).**



**Note:** If at any time the display shows a 'KEY' symbol, it is likely that the timer has been set incorrectly. OVEN COOKING IS NOT POSSIBLE. The 'KEY' symbol can be deleted and the cooker returned to manual operation by:

- Simultaneously pressing the Minute Minder and the Cook Period buttons for a period of approximately 8 seconds.
- Releasing the buttons and pressing the '+' button.

## TIMER FUNCTION BUTTONS

### Minute Minder Button

Here you can set a time period of up to 23 hours 59 minutes, that will count down. When it reaches zero, the timer will emit an audible tone.

**For Example:** If you set 20 minutes, the audible tone will occur 20 minutes later.

### AUTO COOKING PROGRAMME

#### Cook Period Button

Cook Period is the actual length of time for which, the timer will switch the oven(s) on as part of an "Auto Cooking" programme.

(e.g. If you set 2 hours, the food will be cooked for 2 hours).

#### End Time Button

The time of day at which you want an "Auto Cooking" programme to **end**.

**For Example:** If you set a "Cook Period" for 2 hours, and "End Time" of 11:00. The timer will switch the oven(s) on at 9:00 and turn the oven(s) off at 11:00. You will hear a audible tone at 11:00, to indicate that the Auto Cooking Programme has finished.

#### Notes:

- When setting an Auto Cooking programme you will need to set the oven controls(s) to the required temperature(s) when you set the timer.
- If an Auto Cooking programme has been set the oven(s) will only operate during the pre-programmed time.

#### Manual Button

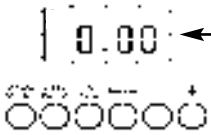
Needs to be pressed to cancel an Auto Cooking programme and return the oven(s) to Manual operation.

#### "+" and "-" Buttons

Used to adjust the various timer function settings.

# Electronic Clock and Automatic Oven Timer Operation

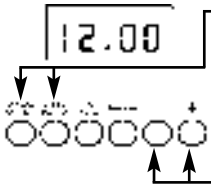
## SETTING THE TIME OF DAY



**Step 1** Make sure all oven controls are turned Off.

**Step 2** Check the electricity supply to the cooker is turned on.

**Step 3** When switched on the display will show 0.00 and Auto symbol will be flashing intermittently.



**Step 4** Press & hold in both the "Minute Minder" & "Cook Period" button together.

**Step 5** With the "Minute Minder" & "Cook Period" buttons still held in, press either the "+" or "-" buttons to set the correct time of day.

**Step 6** Release all the buttons simultaneously.

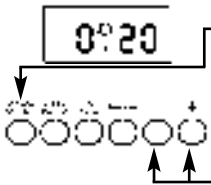
**THE TIME OF DAY IS NOW SET.**

*To change the time of day repeat Steps 4, 5 & 6 above.*

**Note:** You cannot adjust the time of day if the timer has been set for an Auto Cooking Programme.

## SETTING THE MINUTE MINDER


**Step 1** Ensure the time of day is set correctly.




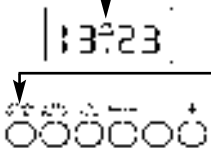
**Step 2** Press and hold the Minute Minder Button, a  symbol will light up.

**Step 3** With the "Minute Minder" button held in, set the required Minute Minder time using the "+" and "-" buttons.

Release all buttons and the timer display will revert back to the time of day. Bell symbol will remain lit to signify that a Minute Minder period has been set.

At the end of the set time a beeping sound will be heard, and the  symbol will flash for approximately 2 minutes.

After approximately 2 minutes the beeping sound will stop and the  symbol will go out automatically.



**Step 4** To cancel the beeping sound within the two minutes press the Minute Minder button.

**Note 1** When the Minute Minder has been set, the time remaining can be checked at any time by simply pressing the Minute Minder button.

**Note 2** If necessary the Minute Minder can be cancelled before the tone sounds by pressing and holding the Minute Minder button and then at the same time pressing the "-" button until 0.00 appears in the display window.

# Electronic Clock and Automatic Oven Timer Operation

## AUTO COOKING PROGRAMMES

There are two Auto Cooking programmes that can be selected using your timer:-

- (a) To set the timer to switch the oven(s) On and Off Automatically
- (b) To set timer to switch on immediately and OFF automatically after a set cook period.

### a) TO SET THE TIMER TO SWITCH THE OVEN(S) ON AND OFF AUTOMATICALLY

*This allows you to cook at a specified time for a chosen period before the oven switches off Automatically.*

- Step 1** Check that the correct time of day is set, if not follow instructions for setting the time of day.
- Step 2** Place food onto the correct shelf position in the oven and close the oven door(s).

**Step 3** Press and hold in the Cook Period button.  
The display will read 0.00 with the cookpot (☺) symbol lit.

**Step 4** With the Cook Period button still held in, set the required Cook Period using the "+" and "-" buttons.

Release the buttons and the timer display will revert to the time of day with the Auto symbol and Cookpot (☺) symbol lit.

**Step 5** Press and hold in the "End Time" button.  
The display will read the earliest possible end time for the Cook Period that you have set above.  
The Auto symbol and Cookpot (☺) symbol lit.

**Step 6** With the End Time button still held in, use the "+" and "-" buttons to set the "End Time" (i.e. The time you require the oven to switch off).

Release all the buttons and the timer will revert back to the time of day.

The "Auto" symbol will remain lit to signify that an Auto Cooking Programme has been set. The (☺) symbol will go out.

**Step 7** Turn the oven control(s) to the required temperature, and if necessary select the appropriate oven function.

**Note: If your appliance has two ovens: When the timer has been set for one oven it is possible to use the other oven only during the same Automatic programme.**

At the end of the Automatic Cook Period the Auto Symbol will flash and an intermittent bleeping sound will be heard.  
The bleeping sound will continue for approximately 2 minutes unless cancelled.  
The "Auto" symbol will continue to flash until the timer is returned to Manual operation (see below).

**Step 8** Press the Manual button to cancel the bleeping sound.  
(If 2 minutes has not elapsed).

**Step 9** Turn the oven control(s) to the OFF position.

**Step 10** Press the manual button again to return the oven(s) to Manual Operation.  
(The Auto symbol will go out)

# Electronic Clock and Automatic Oven Timer Operation

**Note 1** When cooking automatically the Cook Period can be checked at any time by simply pressing the Cook Period button.

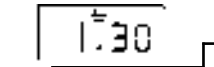
**Note 2** When cooking automatically the End Time can be checked at any time by simply pressing the End Time button.

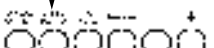
## b) TO SET TIMER TO SWITCH ON IMMEDIATELY AND OFF AUTOMATICALLY AFTER A SET COOK PERIOD

**Step 1** Check that the correct time of day is set, if not follow instructions for setting the time of day.

**Step 2** Place food onto the correct shelf position in the oven and close the oven door(s).

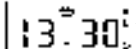
**Step 3** Turn the oven control(s) to the required temperature, and if necessary select the appropriate oven function.

 **Step 4** Press & hold in the "Cook Period" button, the display will read 0.00 and the cookpot (☺) symbol will light up.

 With the Cook Period button still held set the required Cook Period using the "+" and "-" buttons. Example: 1hr 30 minutes (as shown).

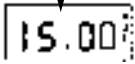
**Note: Cook Period is the length of time the food requires to cook.**

**Step 5** Release all buttons.


 The timer display will revert to the time of day with the Auto symbol lit & Cookpot symbol remaining lit.

NOTE: The Cookpot symbol disappears

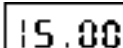
At the end of the Cook Period the "Auto" symbol will flash and an intermittent beeping sound will be heard. The beeping sound will continue for approximately 2 minutes unless cancelled. The "Auto" symbol will continue to flash until the timer is returned to Manual operation (see below).



**Step 6** Press the manual button to cancel the beeping. (If 2 minutes has not elapsed)



**Step 7** Turn the oven control(s) to the OFF position.

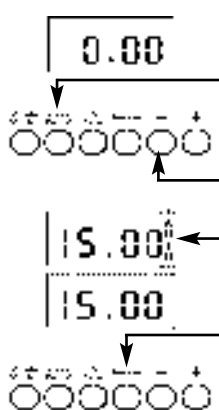


**Step 8** Press the "Manual" button again to return the cooker to Manual operation. (The Auto symbol will go out).



# Electronic Clock and Automatic Oven Timer Operation

## TO CANCEL AN AUTO COOKING PROGRAMME BEFORE THE COOK PERIOD HAS FINISHED.

- 
- Step 1** Turn the oven control(s) to the OFF position.
- Step 2** Press and hold in the "Cook Period" button.
- Step 3** With the "Cook Period" button still held in, return the display to 0.00 by pressing the "-" button.
- Step 4** Release the "Cook Period" and "-" buttons and the display will revert to the time of day and the "Auto" symbol will flash.
- Step 5** Press the "Manual" button to return the oven(s) to "Manual" operation. The "Auto" symbol will go out.

**Note 1** When cooking automatically the Cook Period can be checked at any time by simply pressing the Cook Period button.

## OTHER NOTES ON TIMER OPERATION

1. When cooking Automatically the Cook Period can be checked at any time simply by pressing the Cook Period button.
2. When cooking Automatically the End Time can be checked at any time by simply pressing the End Time button.
3. Having set a Cook Period and End Time an electronic device stores the information. The device within the timer will switch the oven(s) on and off at the required times.
4. When setting an Auto Cooking Programme and a mistake is made, to clear:-
  - (a) Press and hold in the "Cook Period" button.
  - (b) With the Cook Period button still held in, return the display to 0:00 by pressing the "-" button.
  - (c) Release the "Cook Period" & "-" buttons, and the display will revert to the time of day and the "Auto" symbol will flash.
  - (d) Press & release the "Manual" button.
  - (e) Start the sequence again.
5. If at any time the display shows three flashing zero's 0.00. It is likely that the electricity supply to the oven has been interrupted. Reset the timer to the correct time of day.  
**Food in the oven may, therefore, not have been cooked, before serving check food is thoroughly heated and completely cooked.**
6. To set each function always press and hold the required function button and at the same time press "+" or "-" buttons.

**Note:** Between the hours of 22.00 & 06.00 the display dims to prevent glare. However, if you should operate a button during this period, the timer will return to normal brightness for a few seconds and then dim again.

# Solarplus Grill

Your cooker is not fitted with a conventional grill. **Creda** have developed a Solarplus high speed grill which is designed to reduce your grilling times. It is quicker because it takes less time to warm up from cold. Conventional grills require 5 minutes pre-heat before food is placed beneath them, but for normal grilling the Solarplus grill can be used directly from cold without any pre-heat.

However, when toasting, optimum performance is achieved by pre-heating the grill for about 1 minute.

**Note: You will notice that the grill elements are protected by a wire mesh. This stops you from touching live parts.**

**DO NOT under any circumstances insert objects into the grill mesh as this could damage the element wire, break the glass tubes or if the grill is on, cause electric shock.**

During use the mesh may become soiled. Do not attempt to clean it while the grill is still on. Turn off at the control and allow to cool before cleaning. Care must be taken to ensure the grill mesh is not distorted – do not store the grill pan handle on the food grid when the shelf is in the highest position.

## IMPORTANT

**GRILLING SHOULD NEVER BE UNDERTAKEN WITH THE GRILL/TOP OVEN DOOR CLOSED.**

Grilling procedure:

1. Open the door fully.
2. Ensure that the Easy Glide™ Shelf is located in the correct position (see 'Guide to Grilling').
3. Preheat the grill, if necessary, with the Easy Glide™ Shelf pulled out (see Fig 1).
4. Locate the grill pan in the Easy Glide™ Shelf (see Fig 2) and push back under the element.
5. The grill pan should be withdrawn, **always using the grill pan handle**, to the stop position to turn or remove cooked food. (There is no need to remove the grill pan from the Easy Glide™ Shelf).
6. NEVER line the grill pan with aluminium foil as this may cause over heating of fat in the grill pan.

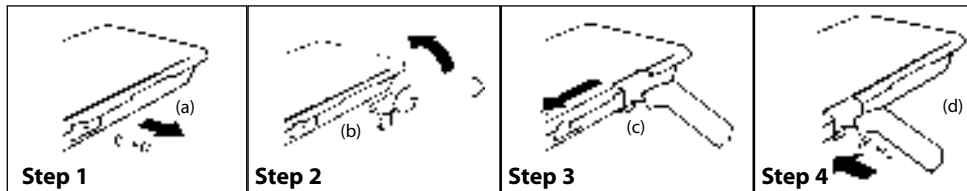
NOTE: To stop fat splashing onto the grill element mesh, it is important to use the anti-splash tray. Always clean the grill pan anti-splash tray and food grid after each use.



- Only use the grill pan supplied.
- Never attempt to remove the Easy Glide™ Shelf with the grill pan in position.
- Always withdraw the Easy Glide™ Shelf to its stop position before removing the grill pan (to avoid damaging the grill).

# Grill Pan and Handle

The grill pan handle is detachable from the pan, to facilitate cleaning and storage. The grill pan handle can be fixed as follows:



**Step 1** Remove the screw and washers from the grill pan bracket (a).

**Step 2** Tilt the handle over the recess (b).

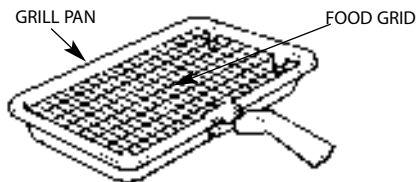
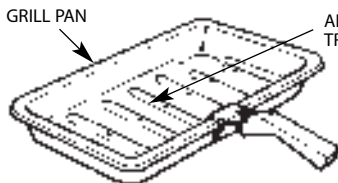
**Step 3** Slide it towards the centre of the pan (c).

**Step 4** Locate the handle over the bracket (d).

For a fixed handle, replace the screw and washers and ensure they are fully tightened up. If a detachable handle is required, do not replace the screw and washers.

**Note: If a fixed handle is required, the grill pan is unable to be kept in the main oven with the door closed.**

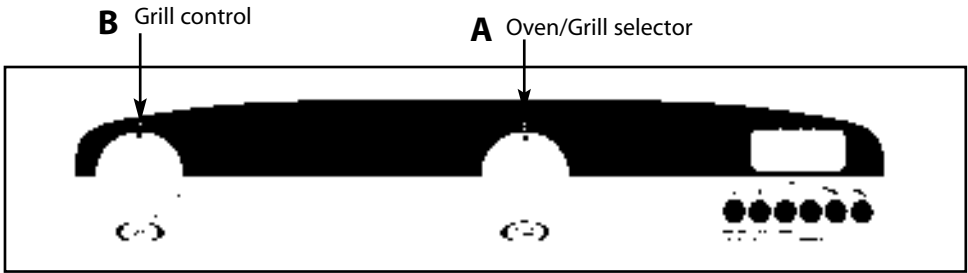
## Grill Pan Food Grid and Anti-Splash Tray



**Note: To stop fat splashing onto the grill mesh, it is important to use the anti-splash tray as shown in the grilling chart. Always clean the grill pan, anti-splash tray and food grid after each use.**



# Grilling Procedure



**Note:** **DO NOT** allow young children near to the appliance when the grill is in use as the surfaces get extremely hot.

**Step 1** Ensure oven timer is set to manual.  
Place the grill pan runner/support in the correct position (see Grill Chart).  
Locate the grill pan in the runner/support, position centrally under the grill element.  
Ensure door is in the grilling position.

**Step 2** Turn knob (A) clockwise to full or half grill function.

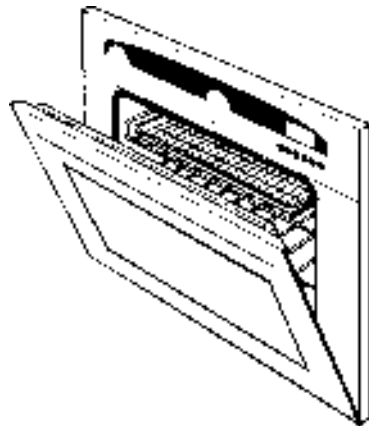
**NOTE:** **Resistance will be felt when turning from fan oven operation to full/half grill position.**

**Step 3** Turn knob (B) clockwise to select the Grill Setting (1–6).  
(1=Low, 6=High).

**NOTE:** **When using the grill, a gentle flow of air will be detected coming from beneath the control panel.**

**Step 4** After use, turn both controls A & B to their off (●) position and close the oven door.

## Door Position for Grilling



**Note:** Do not grill with the oven door closed.

---

# Grill Chart

---

For solarplus grill in single ovens always grill food with the anti splash tray and food grid in position unless stated in the chart

<b>Food</b>	<b>Pre-heat</b>	<b>Easy Glide™ Shelf Position from base of oven</b>	<b>Setting required for cooking</b>	<b>Approx. Cooking Time</b>
Toasting of Bread Products	1 min.	5 or 6	6	3 - 6 mins.
Small cuts of meat – Sausages, Bacon	None	5 or 6	6 for 5-10 mins reduced to 5	10 - 20 mins
Chops, etc. Gammon Steaks	None	5	6 reduced 5 after 8-10 mins	25 - 35 mins
Fish: Whole, Fillets, Fish Fingers.	None	5 or 6	6 reduced 5 after 8-10mins	10 - 20 mins.
Pre-cooked Potato Products	None	5 or 6	5	8 - 15 mins
Pizzas	None	5 or 6	4 or 5	15 - 25 mins
Browning of Food e.g. cauliflower cheese	1 min.	5 or 6	6	10 - 20 mins

The numbers on the grill control relate to heat setting recommended on food packs.:

No. 6 = High

No. 5 = Medium High

No. 4 = Medium

No. 3 = Medium Low

No. 2 = Low

No. 1 = Very Gentle Heat

# Using the Oven for Fan Cooking



Since a circulaire fan oven heats up more quickly, and generally cooks food at a lower temperature than a conventional oven, pre-heating is often unnecessary. For guides on “pre-heating”, “cooking temperatures” and “cooking times”, see “Oven Temperature Charts” later in book.

## Easy Glide™ Shelf

The Easy Glide™ Shelf, in conjunction with the grill pan supplied can be used for cooking in the oven(s), ie. meat, poultry etc. also for roasting vegetables.

Place the Easy Glide™ Shelf in the oven on the same runner position as stated in the meat cooking chart.

## Important:

**Always** remove the grill pan handle from the grill pan, when the pan is being used for oven cooking.

**Always** use oven gloves when basting, turning or removing food from the oven, as the Easy Glide™ Shelf and the pan will be hot.

**Never** remove the Easy Glide™ Shelf from the oven with pan and food still in position.

**NOTE: Charts are a guide only, to suit personal taste and requirements, it may be necessary to increase or decrease temperatures by 10°C. It may also be necessary to increase or decrease cooking times.**

## Oven shelf positioning for fan oven

Most foods will cook satisfactorily on any shelf position, due to even distribution of heat in the oven, but the shelves must be evenly spaced.

**Food or utensils should never be placed directly on the floor of the oven for cooking as air circulation is restricted.**

**DO NOT allow young children near to the appliance when the oven is in use as the surfaces get extremely hot.**

## Oven utensils

Do not use: Meat pans larger than 375mm x 300mm (15" x 12")  
Baking Trays larger than 325mm x 250mm (13" x 10")

An additional oven shelf can be purchased from your oven supplier if a third one is required for batch baking. Never use more than three shelves in the oven as air circulation will be seriously restricted.

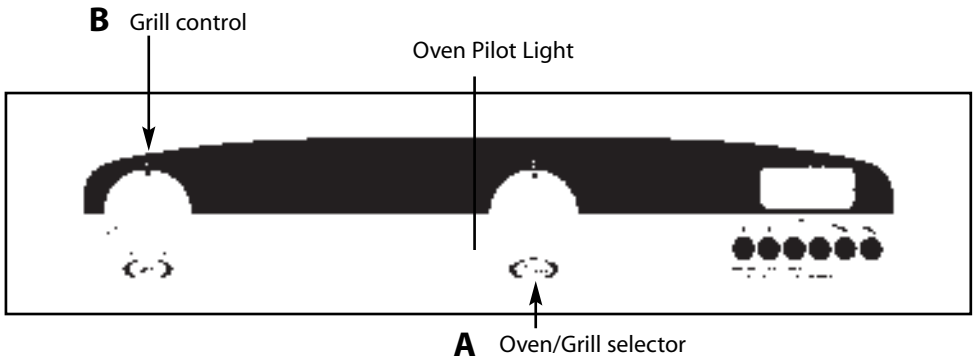
## Temperature and time

If three shelves are in use to cook large quantities of food, it may be necessary to increase the cooking times given in the temperature charts by a few minutes, to allow for the loss of heat due to extra time taken to load the oven, and the larger mass of food. Baking trays should have an even gap around the oven.

# Using the Oven for Fan Cooking

Fan  
Oven

## Fan oven operation



- Step 1** Ensure oven timer is set to manual.  
Ensure that the oven shelf is in the correct position.  
Place food centrally on the shelf ensuring the oven door is fully closed.
- Step 2** Turn knob (A) clockwise and select the required cooking temperature .  
The pilot light will immediately come on, and remain on until the oven reaches the required temperature. The light will then automatically go off and on during cooking as the oven thermostat maintains the correct temperature.
- Step 3** After use turn control (A) to its Off (●) position.

**NOTE:** At the end of a cooking period there may be a momentary puff of steam when the door is opened. This will disperse in a few seconds and is a perfectly normal characteristic of an oven with a good door seal.

---

# Using the Oven for other Functions

---

90

## “SLOW” setting

This is used for slow cooking, keeping food warm and warming plates for short periods. Extra care should be taken when warming bone china, as it may be damaged in a hot oven.

**DO NOT place food or plates directly on the oven floor as this could damage both the oven lining and the plates which are being warmed.**

### Advantages of “SLOW” cooking are:

The oven stays cleaner because there is less splashing.  
Timing of food is not as critical, so there is less fear of overcooking.  
Inexpensive joints of meat are tenderised.  
Fully loading the oven can be economical.  
Cooking times can be extended in some cases by up to 2 hours.  
The kitchen stays cooler.

### Operation:

1. Place the prepared food in the main oven and ensure the door is fully closed.
2. Turn knob A to **90** (slow cooking temperature).

### Storage and re-heating of food:

1. If food is to be frozen or not used immediately, place it in a clean container and cool as soon as possible.
2. Always thaw frozen food completely in the refrigerator before re-heating.
3. Always reheat food thoroughly and ensure it is piping hot before serving.
4. Only re-heat food **once**.

### Points to consider when preparing food for “SLOW” cooking:

1. Make sure that the dishes to be used will fit into the oven ensuring enough room for air to circulate.
2. All dishes cooked on the slow setting will require a minimum of 6 hours, however, if they are cooked for 1-2 hours longer then deterioration in their appearance may be noticed.
3. Never cook joints of meat over 2.7kg (6 lb) or poultry over 2.0kg (4lb 8oz). We do not recommend that joints of meat or poultry are stuffed before cooking on the slow setting.
4. To seal in the meat juices, always cook meat or poultry at 170°C for 30 minutes before wrapping in foil and placing on a rack over a tin (to allow good air circulation) before turning the control to the slow setting and cooking immediately.
5. Always ensure that joints of pork and poultry are thoroughly cooked by checking with a meat thermometer before serving.
6. Always thaw frozen foods completely before cooking. We do not recommend placing frozen food in the oven to cook.
7. Always bring soups, liquids and casseroles to the boil before placing in the oven.
8. Ensure that casserole dishes have a good seal (not airtight) and cover to the top with foil to prevent loss of moisture.
9. Ensure that fruit and vegetables are cut into even sized small pieces to cook properly.
10. Always adjust seasoning before serving.
11. If using dried red kidney beans it is important that the beans are soaked and then boiled for a minimum of 10 minutes before using in any dish to destroy any toxins.
12. When cooking fish or egg dishes it may be necessary to check during cooking to avoid overcooking.

---

## Temperature Conversion Chart

---

<b>Gas Mark</b>	<b>°F</b>	<b>Main Conventional Oven</b>	<b>Main Fan Oven</b>
1/2	250	120	100
1	275	140	120
2	300	150	130
3	325	160	140
4	350	180	160
5	375	190	170
6	400	200	180
7	425	220	200
8	450	–	210
9	475	–	220

# Oven Temperature Chart - Meat

Food	Fan Oven Cooking		
	Note: Up to three shelves may be used in this oven. The position of these is not important providing they are evenly spaced.		
Meat	Pre-heat	Temperature °C	Time (approx.)
Beef	No	160/180	20-25 mins per 450g (1lb) + 20 mins extra
Lamb	No	160/180	25 mins per 450g (1lb) + 25 mins extra
Pork	No	160/180	25 mins per 450g (1lb) + 25 mins extra
Veal	No	160/170	25-30 mins per 450g (1lb) + 25 mins extra
Chicken/Turkey up to 4kg (8lb)	No	160/180	18-20 mins per 450g (1lb) + 20 mins extra
Turkey up to 5.5kg (12lb)	No	150/160	13-15 mins per 450g (1lb) e.g. 5kg (11lb) = 143-165 mins
Turkey over 5.5kg (12lb)	No	150	12 mins per 450g (1lb) e.g. 10kg (22lb) = 264 mins
Casserole / Stews	No	A140/150	1½ - 2 hours

## IF USING ALUMINIUM FOIL

1. Never allow foil to touch sides of oven.
2. Never cover interior with foil.
3. Never cover shelves with foil.

The most accurate method of testing the readiness of joints of meat or whole poultry is to insert a meat thermometer into the thickest part of a joint of meat, or the thickest part of poultry thighs, during the cooking period. The meat thermometer will indicate when the required internal temperature has been reached.

Beef			Pork	Lamb	Poultry	Veal
Rare 60°C	Medium 70°C	Well Done 75°C	90°C	80°C	90°C	75°C

# Oven Temperature Chart - Baking

Baking	Fan Oven Cooking		
	Note: Up to three shelves may be used in this oven. The position of these is not important providing they are evenly spaced.		
Food	Pre-heat	Temperature °C	Time
Scones	Yes	210/220	9-12 mins
Small Cakes	No	170/180	15-25 mins
Victoria Sandwich	No	160/170	20-25 mins
Sponge Sandwich (Fatless)	Yes	170/190	15-20 mins
Swiss Roll	Yes	180/200	12-15 mins
Semi-rich Fruit Cake	No	140/150	1¼-1½ hours
Rich Fruit Cakes	No	130/140	Time depending on use
Shortcrust Pastry	No	190/200	Time depending on use
Puff Pastry	No	190/200	Time depending on use
Yorkshire Pudding	Yes	180/190	40-45 mins
Individual Yorkshire Pudding	Yes	190/200	20-45 mins
Milk Pudding	No	130/140	1½-2 hours
Baked Custard	No	140/150	35-45 mins
Bread	Yes	200/210	20-30 mins
Meringues	No	70/90	3-4 hours

**Note: If soft tub margarine is being used for cake making, we would recommend using the all in one method and to reduce the temperature by 10°C. Temperatures recommended in this chart refer to cakes made with block margarine or butter only.**



---

# Cooking Results Not Satisfactory

---

## Grill

- Uneven cooking front to back**      Ensure that the grill pan is positioned centrally below the grill element.
- Fat splattering**      Ensure that the grill pan is not lined with foil.  
Ensure that the grill setting is not too high.  
Remember to use the anti - splash tray.

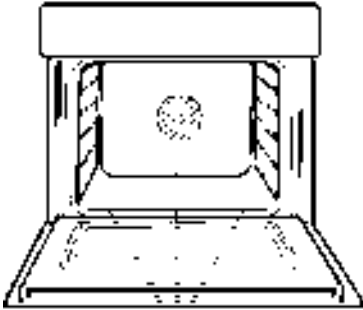
## Baking General

- Uneven rising of cakes**      Ensure that the oven shelves are level.
- Sinking of cakes**      The following may cause cakes to sink:
1. Pre-heating of fan ovens – not always necessary.
  2. Cooking at too high a temperature – reduce standard temperatures by 25°C for fan ovens.
  3. Using normal creaming method with a soft margarine.  
If using soft margarine, use an all in one method instead of the traditional creaming of the margarine and sugar. Remember when using a food mixer or processor not to over-cream soft margarine.
- Over/undercooking**      Refer to the cooking times and temperatures given in the Oven Temperature Charts provided, however, it may be necessary to increase or decrease temperatures by 10°C to suit personal taste.
- Do not use utensils greater than 56mm (2¼") in height for roasting.

# Care and Cleaning

**Warning: Before cleaning, please ensure that the electricity supply to the appliance is switched off and the appliance is fully cold.**

## 1. "CREDACLEAN" OVEN LINERS (E010E)



MAIN OVEN SIDE LINERS  
AND REAR PANEL

### (a) How "Credaclean" works.

The surfaces of the "Credaclean" oven liners are treated with a special vitreous enamel which absorbs cooking soils. At temperatures of 220°C (425°F) or above, the special surface enables these soils to be slowly destroyed. The higher the temperature the more effective it is.

### (b) Cleaning.

In most cases normal cooking operations at 220°C (425°F) will permit this cleaning operation to proceed during cooking. However if higher cooking temperatures are not used regularly, it may be necessary, in order to prevent heavy soiling, to run the ovens without shelves or meat pan, at a maximum setting for a couple of hours. It should not normally be necessary to clean the "Credaclean" panels with water. If the user feels it is desirable to do so, wipe them over with a clean, soapy cloth, followed by a wipe with a clean damp cloth.

**DO NOT use biological washing powder, harsh abrasives or chemical oven cleaners of any kind as this could damage the "Credaclean" oven liners.**

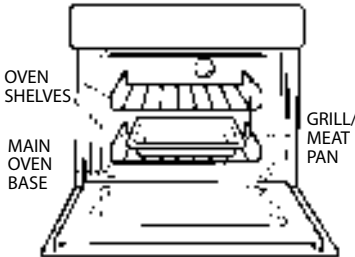
## 2. VITREOUS ENAMEL OVEN LINERS (R010E)

### Cleaning.

These can be cleaned by wiping them over with a clean, soapy cloth, followed by a wipe with a clean damp cloth. For more stubborn stains on the side liners use a well soaped, fine steel wool soap pad.

# Care and Cleaning

## 3. CLEANING THE OVEN



### (a) Base of Main Oven.

Wipe out the oven with a damp soapy cloth. For more stubborn stains on the base of the oven use a well soaped fine steel wool soap pad.

### (b) Grill/Meat Pan & Oven Shelves.

To prevent stains from being burnt on to the grill pan, food support and rod shelf, always wash immediately after use in hot soapy water. Use a well soaped fine steel wool soap pad to remove stubborn stains from the rod shelves, grill/meat pan and the base of the oven.

**DO NOT use aerosol cleaners on this oven as they could adversely affect the fan motor unit, and cannot be wiped off the fan blade.**

### (c) Solarplus Grill

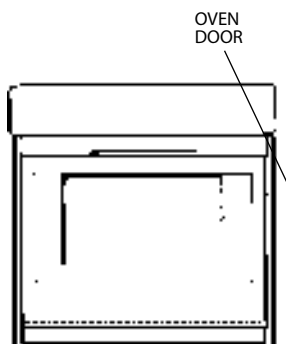
To clean the Solarplus grill, use a clean, damp, soapy cloth and wipe over. If stubborn stains remain, gently clean with a well soaped nylon scouring pad and wipe over with a damp cloth.

NOTE: Take care when cleaning the Easy Glide™ Shelf not to trap fingers between mating parts.

**DO NOT use metal cleaning utensils, wire wool or proprietary oven cleaners on the grill element mesh.**

# Care and Cleaning

## 4. CONTROL PANEL / TRIMS / INNER DOOR PANEL & GLASS



TRIMS

### (a) Control Panel

Regularly wipe with a clean, damp cloth and polish with a clean, dry cloth.

### (b) Trims

It is advisable to clean the trims regularly to prevent any build up of soiling which may detract from the appearance of the cooker. The recommended method of cleaning is to wipe over the trims with a clean, soft cloth wrung out in hot water, or mild non abrasive cleaner. (If in doubt try the cleaner on a small area of trim which is not noticeable in normal use), then after wiping with a cloth wrung out in clear water, dry with a clean, soft cloth.

### (c) Inner Door Panels & Glass

Open the door fully. The glass panel may now be washed. Stubborn stains can be removed by using a well soaped, fine steel wool soap pad.

**DO NOT use scouring pads, or abrasive powder, which will scratch the glass.**

## 5. REPLACEMENT OF THE OVEN LAMP

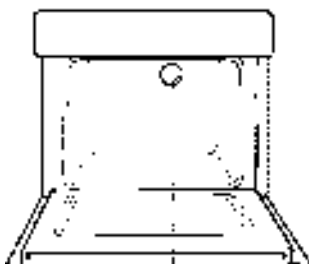


MAIN OVEN LAMP

**Warning: Before removing lamp lens, please ensure that the electricity supply to the appliance is switched off and the appliance is fully cold.**

Open the oven door and remove the oven shelves. Using a thick cloth, grip the lamp lens, unscrew anti-clockwise and remove the lens. Carefully unscrew the bulb anti-clockwise. Fit replacement bulb (15W 300°C SES). Fit replacement bulb and refit lens.

## 6. HOW TO CLEAN THE LAMP LENS



MAIN OVEN LAMP

**Warning: Before cleaning lamp lens, please ensure that the electricity supply to the appliance is switched off and the appliance is fully cold.**

Open the oven door and remove the oven shelves. Using a thick cloth, grip the lamp lens, unscrew anti-clockwise and remove. Clean with a non-abrasive cleansing cream and refit lamp lens.

**DO NOT use scouring pads, or abrasive powder, which will scratch the glass lens**

---

# Care and Cleaning

---

Take particular care not to damage the inner surface of the door inner glass that is coated with a heat reflective layer. Do not use scouring pads, or abrasive powder, which will scratch the glass. Ensure that the glass panel is not subjected to any sharp mechanical blows.

Stubborn stains can be removed by using a fine steel wool pad. For slight soiling the inner glass panel may be cleaned, while still warm, without removing it from the door. After cleaning, rinse and dry with a soft cloth.

## CLEANING THE DOORS

### SIDE OPENING DOORS

Cleaning the door glass is the same as the drop down doors, except take care to support the weight of the inner glass when removing and refitting.

### DROP DOWN DOORS

Remove the door inner glass as follows.

1. Open the door fully and unscrew the two screws securing the glass panel so that the securing brackets can be turned. There is no need to remove the screws completely.
2. Turn the brackets so that the glass can be removed and cleaned at the sink (Fig. 1.)

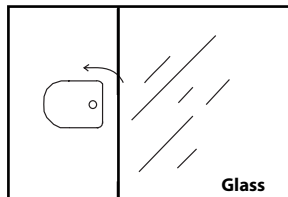


Fig. 1.

3. The inside of the outer door glass can now be cleaned while still fitted to the cooker.

## NEVER OPERATE THE COOKER WITHOUT THE INNER DOOR GLASS IN POSITION.

Refit the door inner glass as follows.

1. **NOTE:** The inner door glass has a special reflective coating on one side. Replace the door inner glass so that the statement: **"IMPORTANT THIS FACE TOWARDS THE OVEN"** can be read from the inner side of the door.
2. Turn the two securing brackets back to their original position to retain the glass and tighten the screws. (Fig. 2.)

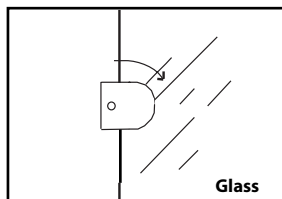


Fig. 2.

---

# Installation Instructions

---

## Important

This equipment is designed specifically for domestic purposes and Creda Limited cannot accept responsibility if used in any other type of installation.

All Creda oven units are suitable for installation under Creda hob units.

This appliance must not be installed over any appliance that generates heat.

For your own safety, we recommend that your appliance is installed by a competent person – such as one who is registered with NICEIC (National Inspection Council for Electrical Installation Contracting). The cooker should be installed in accordance with the latest Edition of the IEE Regulations.

## 1. General

### **WARNING: THIS APPLIANCE MUST BE EARTHED.**

- (a) The oven unit is designed for mounting at a safe level into an oven housing which must be secured to the backing wall, or alternatively, in the case of the single oven unit, under a worktop with or without a hob unit above.
- (b) In an oven/hob arrangement where it is proposed to install the oven directly below the hob. It is advisable that only slimline hobs are used which have the following maximum depths.

Kitchen Worktop thickness	Maximum hob depth (from worktop surface vertically down)
30mm	55mm
40mm	65mm
40mm +	Worktop thickness + 25mm

It is most important that the hob installation instructions are strictly observed.

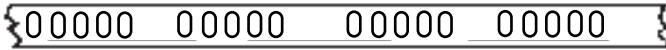
---

# Installation Instructions

---

## 2. Oven Unit Housing Cabinets

- (a) The oven unit housing cabinet dimensions must comply with Fig. 3 and Fig. 4.
- (b) An air gap of 50mm minimum must be provided at the rear of any top or bottom cupboards or shelves for ventilation.
- (c) Do not obstruct the ventilation slots provided on the oven trim. This is found adjacent to the bottom of the oven door.



- (d) The air gap at the rear allows the warmed air to pass out of the cabinet. If cabinets extend up to the ceiling, the warm air must be exhausted through to the front. Fig. 1.
- (e) If an oven unit is installed adjacent to a tall cabinet, steam escaping from the oven when the door is opened could condense on, and perhaps stain the adjacent surface. To prevent permanent staining, the adjacent surface should be made of a material that is heat resisting and easy to clean. Adjacent tall cabinets should not be deeper than the oven housing cabinet.

### Important

It is essential that the lower cupboard is constructed in the manner illustrated i.e. having side, back and roof panels so joined as to provide no apertures which could permit access to the oven unit when installed.

## 3. Electrical Installation

### Mains Supply

A 20 amp Double Pole control switch with a minimum contact clearance of 3mm must be fitted on or recessed in the wall adjacent to the oven housing cabinetry and should be accessible after installation. If the oven is to be wired into a connector unit this may be positioned behind the oven providing:-

- i. The top of the connector unit is not more than 30cm above the base of the oven recess – see Fig. 4.
- ii. The depth of the connector unit does not reduce the depth of the oven recess to less than 55cm.

We recommend that 4mm<sup>2</sup> twin and earth PVC insulated cable is used to connect the cooker to the control unit. This power supply cable must conform to BS 6004.

Alternatively the mains supply can be taken from a household 13 amp switched fused spur. Having a minimum contact clearance of 3mm which must be fitted adjacent to the oven housing cabinetry and accessible after installation. The oven must be fitted with a 3 core cable having a minimum cross sectional area of 1.5mm<sup>2</sup> and must conform to BS6500.

The oven **must not** be connected using a 3 pin 13 amp plug.

---

# Installation Instructions

---

Any spare cable must be coiled either behind the oven (not more than 30cm above the base of the oven recess) or pushed into the air gap below the oven after installation.

Where a hob is fitted adjacent to or above an oven a 30 amp or 45 amp double pole switch with a minimum contact clearance of 3mm should be used to feed both units via separate suitably rated cables.

Where a hob unit is fitted above the oven unit we recommend that 85°C High Temperature PVC with insulated 3 core flexible cord to table 15 of BS 6141:1991 with a conductor size of 2.5mm<sup>2</sup> must be used to connect the hob to the control unit.

Where a hob unit is fitted adjacent to the oven unit, then 4mm<sup>2</sup> twin and earth cable to BS 6004 is recommended to connect the hob unit to the control unit.

**In all cases adhere to routing details (see fig. 5).**

Your cooker should have been checked to ensure that the voltage corresponds with your supply voltage, this is stated on the rating plate which is located on the oven front frame (lower).

## Conduit Box to Mains Terminal Block

- (a) The oven unit should be placed on the floor on its carton base in front of the housing cabinet. The rear of the unit should be in line with the conduit box.
- (b) Ensure there is sufficient cable for any future servicing.
- (c) Remove the terminal cover. Prepare the cable, pass it through the cable entry hole in the oven rear panel and fit to terminal block. Secure the cable clamp and replace the terminal cover.

## 4. Final Installation

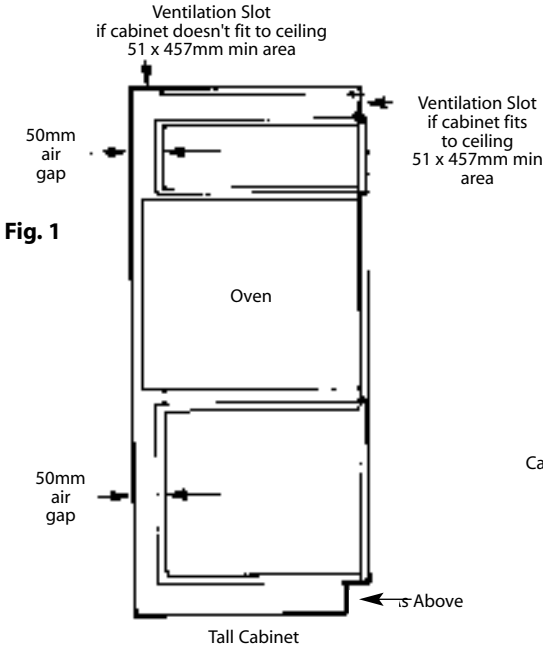
- (a) Using a spirit level, check that the housing cabinet is level from side to side and from front to back in its installed position.
- (b) Correct any unevenness by placing spacers under the bottom of the cabinet. Make sure that the cabinet rests firmly on the floor without rocking.
- (c) Before the oven is fitted the cabinet must be firmly secured to the backing wall for stability.
- (d) The oven unit should now be lifted (this requires two people) into the cabinet and pushed fully home.
- (e) Finally the oven unit must be secured to the cabinet. Position the oven side trims equally about the cabinet sides. This should give an overlap of approx. 1.5mm per side (see Fig. 2). Secure the oven unit to the cabinet, through the side trims, by means of the four screws provided, two each side trim.
- (f) Remove all packing material from the grill and oven interior.

## List of Loose Items:

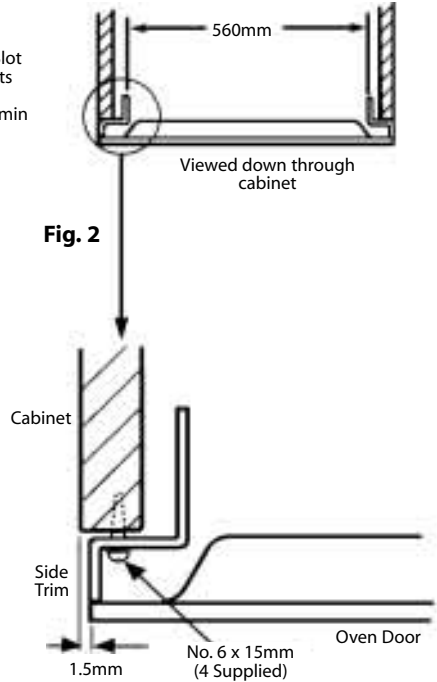
4 x No.6 Pozi Head screws



# Installation Instructions

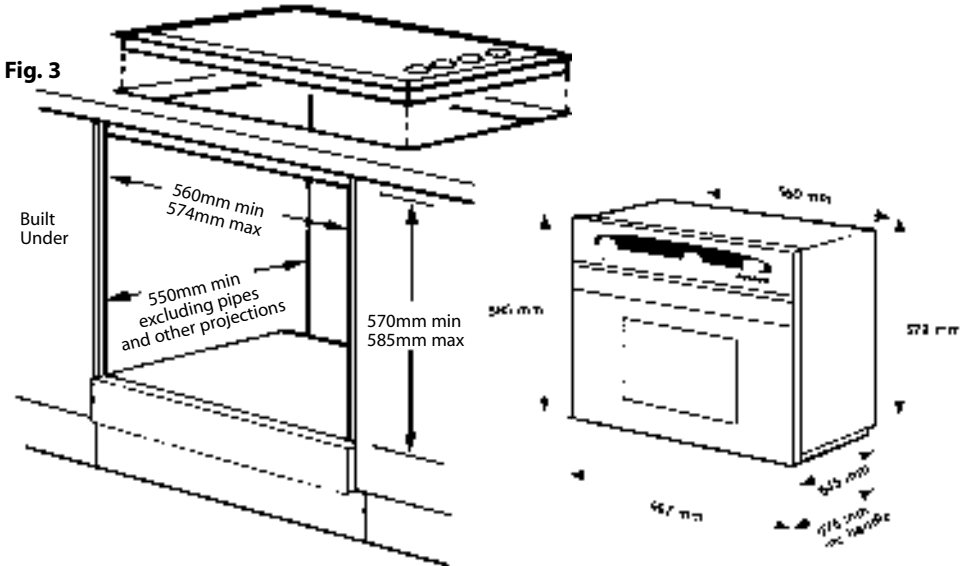


**Fig. 1**



**Fig. 2**

When fitting a hob above an oven always use these installation instructions in conjunction with the hob instructions. Use 2.5mm<sup>2</sup> High Temp Cable. Refer to Electrical Installation.



**Fig. 3**

# Installation Instructions

Fig. 4

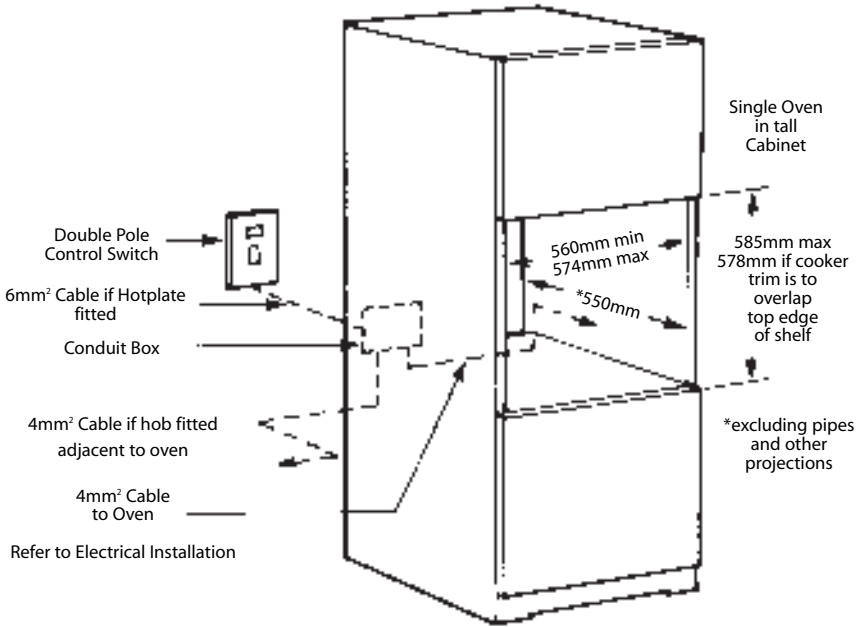
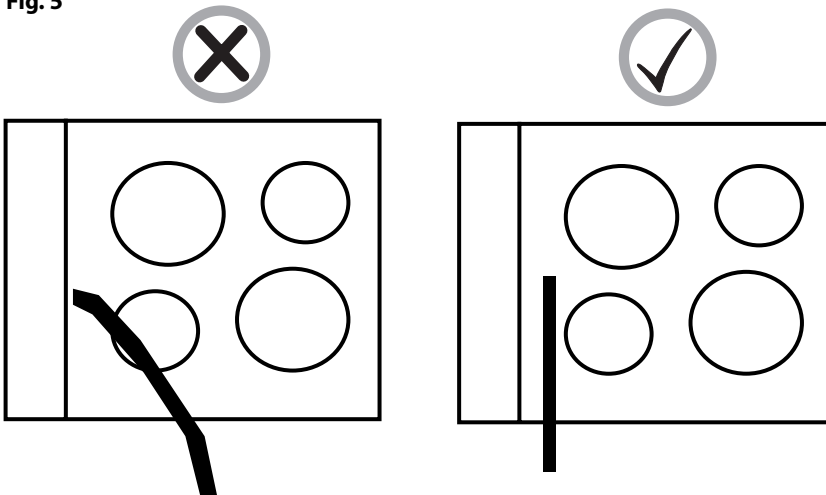


Fig. 5



# Something Wrong?

Before calling a Service Engineer, please check through the following lists.  
**THERE MAY BE NOTHING WRONG.**

Problem	Check
Nothing works.	(a) Check If you find :- Display is blank. <b>Then it is likely that there is no electricity supply to your oven.</b> Check: (i) That the main cooker wall switch is turned on. (ii) Check other appliances to see if you have a power cut. (iii) Check the main circuit breaker for the property. (iv) With oven selected, the oven light does not illuminate.
Display shows 0.00 AUTO.	The power supply to your oven has possibly been interrupted, but has now come back on again. Reset the timer to the correct time of day and "Manual" operation using instructions given in the timer section of the book.
Fan oven does not work but the grill works.	<b>Check to ensure that the timer is in Manual Mode:</b> <b>See timer section for instructions on how to return timer to "Manual".</b>
Fan Oven and Grill do not work.	Operating the cooker under the following conditions may cause a safety device to operate. (a) Grilling with the door closed - always grill with the door open to the correct position - see grilling. (b) Grilling for an excessively long period at maximum setting - see grilling guide. (c) Grilling with inadequate ventilation in the cabinet - see installation instructions.
Grill does not work.	Check that you have selected :- "Grill" function on the "Fan oven/Grill Select" knob (A) <b>and</b> a Grill setting on the Grill Knob (B) - see grilling page.
Grill keeps turning on and off.	When the Grill control (B) is operating at less than "6", the grill will cycle on and off, this is normal and is <u>not</u> a fault.
Can not set an "Auto Cook" programme	Remember: "Cook Period" is the actual length of time for which, the timer will switch the oven on as part of an "Auto Cooking" programme.
Draught from beneath control panel.	A gentle flow of air will be blown from beneath the control panel when the appliance is used. If the appliance is still warm, this cooling fan may run on, or restart itself after all of the controls have been turned off. The fan will stop once the appliance has been cooled. This is normal and <b>not</b> a fault.
Timer buzzer/bleeper operates continually	Buzzer/Bleeper should stop automatically after a short time. If not, press minute minder button to silence.

**If you have been through the above list and there is still a problem; You should identify your Service Agent using the list on the back page and contact your Local Service Office.**

# ***Key Contacts***

## ***Service***

Creda has the largest appliance manufacturer's service team in Europe, trained specialists directly employed by us to ensure your complete confidence.

### ***Repair Service***

***UK: 08709 066 066***

***Republic of Ireland: 1850 302 200***

You will be asked for the following information:-

Name, address and postcode.

Telephone number

Model / Serial number of the appliance

Clear and concise details of the query or fault

Place and Date of purchase

(Please keep the receipt as evidence will be required when the engineer calls).

### ***Extended Warranty***

***To join: UK 08709 088 088***

***Republic of Ireland: 1850 502 200***

### ***Genuine Parts & Accessories***

#### ***Mail Order Hotline***

***UK: 08709 077 077***

***Republic of Ireland: (01) 842 6836***

For further product information 08701 546474

All Creda Services are offered as an extra benefit and do not affect your statutory rights.

# **Creda**

General Domestic Appliances Limited, Morley Way, Peterborough, PE2 9JB

## Free Manuals Download Website

<http://myh66.com>

<http://usermanuals.us>

<http://www.somanuals.com>

<http://www.4manuals.cc>

<http://www.manual-lib.com>

<http://www.404manual.com>

<http://www.luxmanual.com>

<http://aubethermostatmanual.com>

Golf course search by state

<http://golfingnear.com>

Email search by domain

<http://emailbydomain.com>

Auto manuals search

<http://auto.somanuals.com>

TV manuals search

<http://tv.somanuals.com>