

**THE
SINGING
MACHINE®**

Instruction Manual

THE LEADER IN HOME KARAOKE™

STVG-989

- **Semi-Pro Compact Disc + Graphics with Built-In TV, Video Camera Karaoke Center**

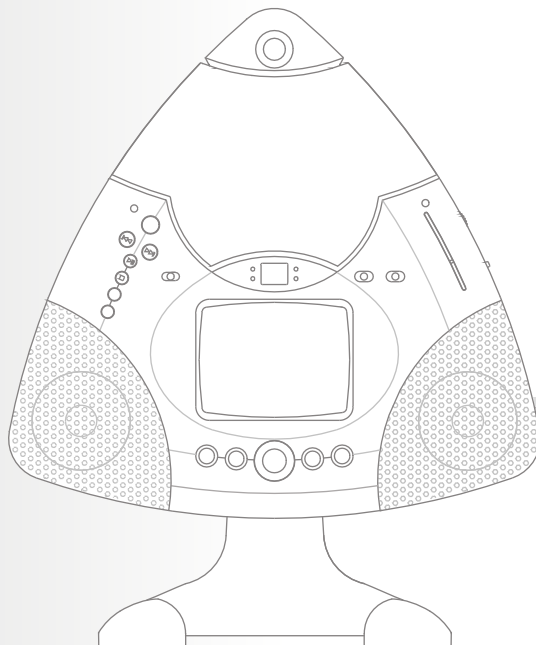

Please read before using this unit.



The Singing Machine® is a registered trademark of The Singing Machine Co., Inc.

WARNINGS

WARNING: TO REDUCE THE RISK OF FIRE OR SHOCK HAZARD, DO NOT EXPOSE THIS PRODUCT TO RAIN OR MOISTURE.

| | | |
|--|---|---|
|  | CAUTION RISK OF ELECTRIC SHOCK DO NOT OPEN |  |
| <p>CAUTION: TO PREVENT THE RISK OF ELECTRIC SHOCK, DO NOT REMOVE COVER OR BACK. NO USER-SERVICEABLE PARTS INSIDE. REFER SERVICING TO QUALIFIED PERSONNEL.</p> | | |



This symbol is intended to alert you of the presence of un-insulated dangerous voltage within the product's enclosure that might be of sufficient magnitude to constitute a risk of electric shock. Do not open the product's case.



This symbol is intended to inform you that important operating and maintenance instructions are included in the literature accompanying this product.

CAUTION

TO PREVENT ELECTRIC SHOCK, MATCH WIDE BLADE OF PLUG TO WIDE SLOT, FULLY INSERT.

DRIPPING WARNING

The product shall not be exposed to dripping or splashing and that no objects filled with liquids, such as vases, shall be placed on the product.

VENTILATION WARNING

The normal ventilation of the product shall not be impeded for intended use.

This CD player is made and tested to meet exacting safety standards. It meets FCC requirements and complies with safety performance standards of the U.S. Department of Health and Human Services.

Warnings:

- This CD player employs a laser light beam. Only a qualified service person should remove the cover or attempt to service this device, due to possible eye injury.
- The use of controls, adjustments, or procedures other than those specified herein might result in hazardous radiation exposure.
- The apparatus shall be used in an open area.

CAUTION

This compact disc player is classified as a CLASS 1 LASER product. The CLASS 1 LASER PRODUCT label is located on the rear panel.



CAUTION!

Invisible laser radiation when open and inter locks defeated. Avoid exposure to beam.

IMPORTANT

Since CD circuitry may cause interference to other radio tuners nearby, switch this unit off when not in use or move it away from the affected radio tuner.

WARNINGS

NOTE: This digital apparatus does not exceed the Class B limits for radio noise emissions from digital apparatus as set out in the Radio Interference Regulations of Industry Canada. These limits are designed to provide reasonable protection against harmful interference in a residential installation. This equipment generates, uses and can radiate radio frequency energy and, if not installed and used in accordance with the instructions, may cause harmful interference to radio communications. However, there is no guarantee that interference will not occur in a particular installation. If this equipment does cause harmful interference to radio or television (which can be determined by turning the equipment off), the user is encouraged to try to correct the interference by one or more of the following measures:

- Reorient or relocate the receiving antenna.
- Increase the separation between the equipment and receiver.
- Connect the equipment into an outlet on a circuit different from that to which the receiver is connected.
- Consult the dealer or an experienced radio / TV technician for help.

IMPORTANT SAFETY INSTRUCTIONS

1. **Read Instructions** - All the safety and operating instructions should be read before the product is operated.
 2. **Retain Instructions** - The safety and operating instructions should be retained for future reference.
 3. **Heed Warnings** - All warnings on the product and in the operating instructions should be adhered to.
 4. **Follow Instructions** - All operating and use instructions should be followed.
 5. **Cleaning** - Unplug this product from the wall outlet before cleaning. Do not use liquid cleaners or aerosol cleaners. Use a damp cloth for cleaning the exterior only. Do NOT attempt to clean the inside.
 6. **Attachments** - Do not use attachments not recommended by the product manufacturer as they may cause hazards.
 7. **Water and Moisture** - Do not use this product near water - for example, near a bath tub, wash bowl, kitchen sink, or laundry tub; in a wet basement, or near a swimming pool, and the like.
 8. **Accessories** - Do not place this product on an unstable cart, stand, tripod, bracket, or table. The product may fall, causing serious injury to a child or adult, and serious damage to the product. Use only with a cart, stand, tripod, bracket, or table recommended by the manufacturer, or sold with the product. Any mounting of the product should follow the manufacturer's instructions, and should use a mounting accessory recommended by the manufacturer.
 9. A product and cart combination should be moved with care. Quick stops, excessive force, and uneven surfaces may cause the appliance and cart combination to overturn.
- 
10. **Ventilation** - Slots and openings in the cabinet are provided for ventilation and to ensure reliable operation of the product and to protect it from overheating, and these openings must not be blocked or covered. The openings should never be blocked by placing the product on a bed, sofa, rug, or other similar surface. This product should not be placed in a built-in installation such as a bookcase or rack unless proper ventilation is provided.
 11. **Power Sources** - This product should be operated only from the type of power source indicated on the marking label. If you are not sure of the type of power supply to your home, consult your product dealer or local power company. For products intended to operate from battery power, or other sources, refer to the operating instruction.
 12. **Grounding or Polarization** - This product may be equipped with a polarized alternating current line plug (a plug having one blade wider than the other). This plug will fit into the power outlet only one way. This is a safety feature. If you are unable to insert the plug fully into the outlet, try reversing the plug. If the plug should still fail to fit, contact your electrician to replace your obsolete outlet. Do not defeat the safety purpose of the polarized plug.
Alternate Warnings - This product may be equipped with a three-wire grounding-type plug, a plug having a third (grounding) pin. This plug will only fit into a grounding-type power outlet. This is a safety feature. If you are unable to insert the plug into the outlet, contact your electrician to replace your obsolete outlet. Do not defeat the safety purpose of the grounding-type plug.

IMPORTANT SAFETY INSTRUCTIONS

13. Power-Cord Protection - Power supply cords should be routed so that they are not likely to be walked on or pinched by items placed upon or against them, paying particular attention to cords at plugs, convenience receptacles, and the point where they exit from the product.

14. Protective Attachment Plug - The product is equipped with an attachment plug having overload protection. This is a safety feature. See Instruction Manual for replacement or resetting of protective device. If replacement of the plug is required, be sure the service technician has used a replacement plug specified by the manufacturer that has the same overload protection as the original plug.

15. Outdoor Antenna Grounding - If an outside antenna is connected to the receiver, be sure the antenna system is grounded so as to provide some protection against voltage surges and built-up static charges. Article 810 of the National Electrical Code, ANSI/NFPA 70, provides information with regard to proper grounding of the mast and supporting structure, grounding of the lead-in wire to an antenna-discharge unit, size of grounding conductors, location of antenna-discharge unit, connection to grounding electrodes, and requirements for the grounding Electrode. See figure:

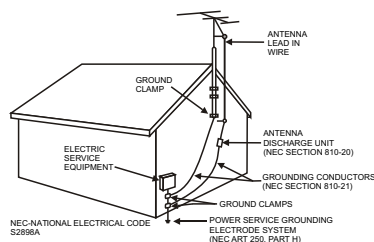

16. Lightning - For added protection for this product during a lightning storm, or when it is left unattended and unused for long periods of time, unplug it from the wall outlet and disconnect the antenna or cable system. This will prevent damage to the product due to lightning and power-line surges.

17. Power Lines - An outside antenna system should not be located in the vicinity of overhead power lines or other electric light or power circuits, or where it can fall into such power lines or circuits. When installing an outside antenna system, extreme care should be taken to keep from touching such power lines or circuits as contact with them might be fatal.

18. Overloading - Do not overload wall outlets, extension cords, or integral convenience receptacles as this can result in a risk of fire or electric shock.

19. Object and Liquid Entry - Never push objects of any kind into this product through openings as they may touch dangerous voltage points or short-out parts that could result in a fire or electric shock. Never spill liquid of any kind on the product.

20. Servicing - Do not attempt to service this product yourself as opening or removing covers may expose you to dangerous voltage or other hazards. Refer all servicing to qualified service personnel.

21. Damage Requiring Service - Unplug this product from the wall outlet and refer servicing to qualified service personnel under the following conditions:

- When the power-supply cord or plug is damaged,
- If liquid has been spilled, or objects have fallen into the product,
- If the product has been exposed to rain or water,
- If the product does not operate normally by following the operating instructions. Adjust only those controls that are covered by the operating instructions as an improper adjustment of other controls may result in damage and will often require extensive work by a qualified technician to restore the product to its normal operation.
- If the product has been dropped or damaged in any way, and
- When the product exhibits a distinct change in performance - this indicates a need for service.

22. Replacement Parts - When replacement parts are required, be sure the service technician has used replacement parts specified by the manufacturer or have the same characteristics as the original part. Unauthorized substitutions may result in fire, electric shock, or other hazards.

23. Safety Check - Upon completion of any service or repairs to this product, ask the service technician to perform safety checks to determine that the product is in proper operating condition.

24. Wall or Ceiling Mounting - The product should be mounted to a wall or ceiling only as recommended by the manufacturer.

25. Heat - The product should be situated away from heat sources such as radiators, heat registers, stoves, or other products (including amplifiers) that produce heat.

INTRODUCTION

Your Semi-Pro Compact Disc+Graphics with Built-In TV, Video Camera Karaoke Center will provide you with fun and entertainment. It can let you be the "star" as you sing along with your favorite recordings and hear your voice with the music through the system's speaker.

This Karaoke System is compact and designed to include many features, yet it is easy to use. Just a few simple instructions and you will become an expert. Before you attempt to use your unit, please read this manual thoroughly to familiarize yourself with all the features available and the sections of the manual that describe their operation. Next go to the section for the specific operation you wish to perform.

For your easy reference, listed here are some of the main features of this Karaoke Center:

Lyrics on TV screen - displays the lyrics with the tempo of music when playing CD+G discs.

Auto Voice Control (A.V.C.) - lets you replace the original singer's voice with your own voice when any prerecorded multiplex disc is played. To activate, just rotate Mic Volume to a comfortable listening level, and Auto Voice Control for the best balance between playback and microphone levels.

Balance Control - lets you adjust the balance between the prerecorded original singer's voice and the music if you use a multiplex karaoke recording.

Echo Control - lets you add reverb to enrich your voice for a concert hall effect.

Master Volume Control - lets you turn the volume control clockwise or counter-clockwise until desired volume level is obtained.

KaraokeVision™ - camera lens to display your image on the Singing Machine's monitor or TV.

Built-In Speaker - lets you share the music with your family or friends.

Auxiliary Output Jacks - let you connect another audio output component, such as an equalizer/booster or a PA system.

Headphone Jack - lets you connect the headphones instead of using the built-in speaker.

CONTROL LOCATIONS

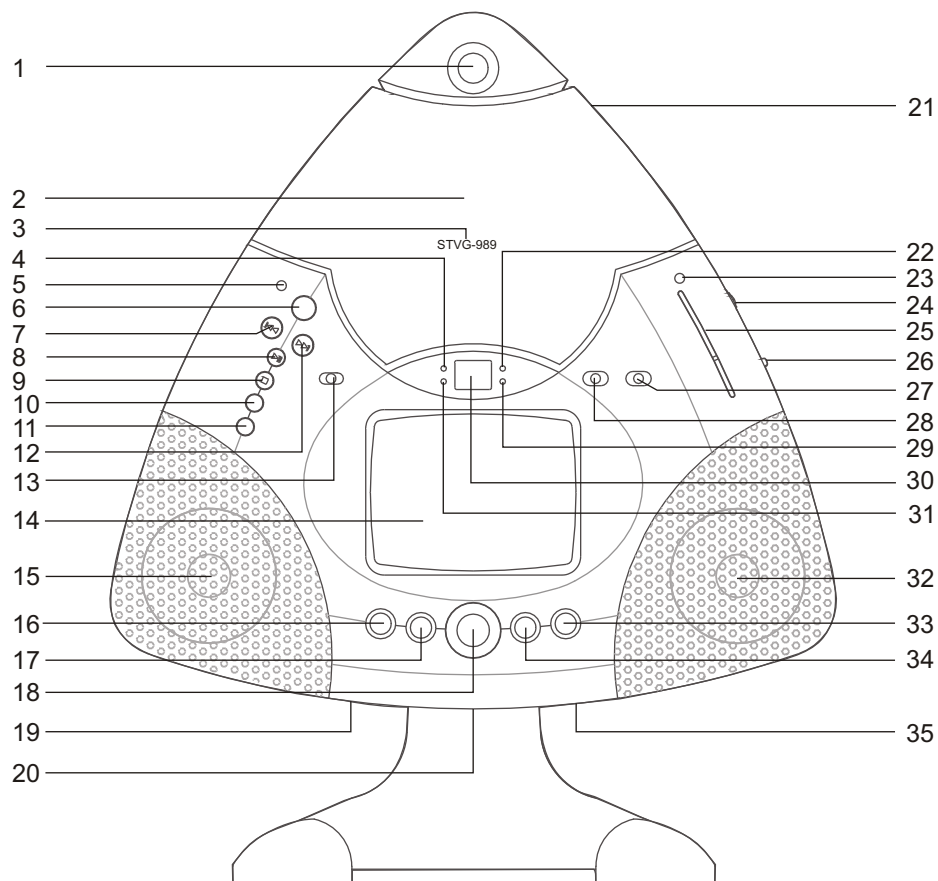

FRONT VIEW

- | | | |
|---------------------------|---------------------------|------------------------|
| 1. Adjustable Camera Lens | 13. Function Selector | 25. Dial Pointer |
| 2. CD Door | 14. Monitor Selector | 26. Band Selector |
| 3. Model Number | 15. Speaker | 27. Video Out Selector |
| 4. PLAY/PAUSE LED | 16. Mic Volume Control | 28. Monitor Selector |
| 5. ON/OFF LED | 17. Auto Voice Control | 29. REPEAT LED |
| 6. ON/OFF Button | 18. Master Volume Control | 30. LED Display |
| 7. SKIP Button ◀◀ | 19. Mic 1 Jack | 31. PROGRAM LED |
| 8. PLAY/PAUSE Button | 20. Headphone Jack | 32. Speaker |
| 9. STOP Button | 21. CD Door Open Lid | 33. Echo Control |
| 10. PROGRAM Button | 22. CDG LED | 34. Balance Control |
| 11. REPEAT Button | 23. FM Stereo Indicator | 35. Mic 2 Jack |
| 12. SKIP Button ▶▶ | 24. Tuning Knob | |

CONTROL LOCATIONS

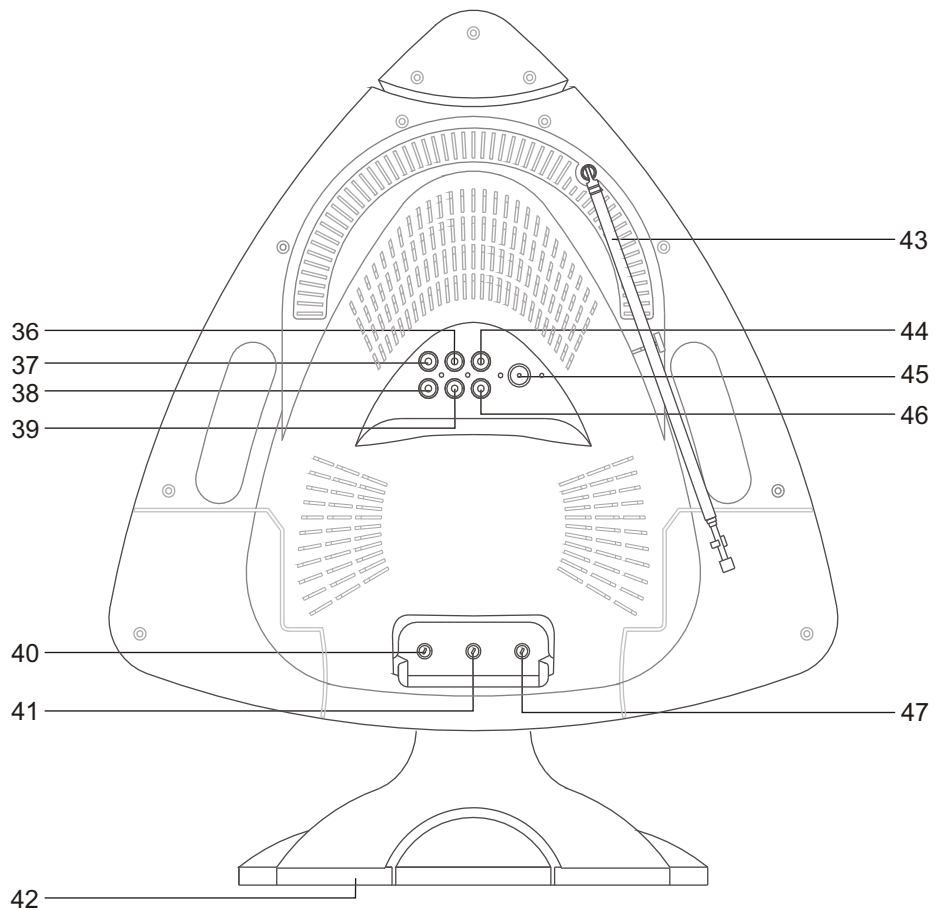

REAR VIEW

36. AUX OUT Jack (L)
37. VIDEO IN Jack
38. VIDEO OUT Jack
39. AUX OUT Jack (R)

40. Contrast Control
41. Brightness Control
42. AC Power Cord
43. Rod Antenna

44. AUX IN Jack (L)
45. Antenna Jack
46. AUX IN Jack (R)
47. Vertical Hold Control

MAKING THE CONNECTIONS

CONNECTING POWER

You can power the system from a standard AC outlet by using the supplied power cord.

CAUTION: The supplied AC power cord has a polarized plug that fits into the wall outlet only one way. If the plug does not fit properly, turn it over and try again. Do not force it.

CONNECTING TO YOUR HEADPHONE

A headphone jack is provided for using headphones instead of the built-in speaker. (Headphones are sold separately.)

CONNECTING TO YOUR TV

The Singing Machine provides a patch cord to give you the option of connecting your unit to an external audio/sound system and video device. The patch cord has three RCA jacks at each end, white and red are for left and right audio connections and the yellow is for connecting the video.

Make sure that you have a CDG disc in the Singing Machine and playing when you are making this connection. You will know you have the proper settings on your TV or VCR as soon as you see the Singing Machine logo or lyrics on the screen!

VIDEO CONNECTION

Please follow the steps below to display CDG lyrics on the TV screen:

- (1) Locate the multicolored patch cords.
- (2) Connect video cable (yellow) to the Video Out of the back of the Singing Machine.
- (3) Connect the other end of the video patch cord (yellow) to the Video Input on your TV or VCR.

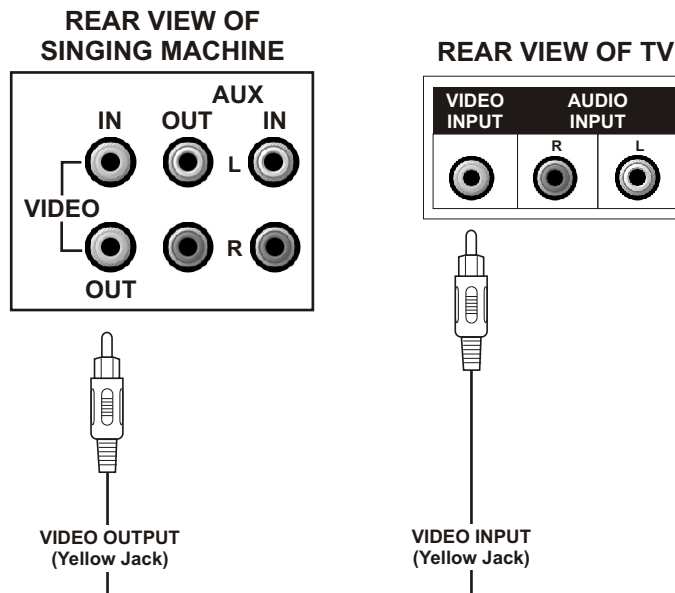

MAKING THE CONNECTIONS

If your television does not have the required Video Input, you will need an RF Modulator (Radio Frequency Modulator), which connects through your TV Antenna or cable line and serves as Video Input.

An RF Modulator can be purchased at almost any consumer electronics retailer. If you are connecting the video from the Singing Machine to either a television or a VCR video input jack, you must specify the source the TV or VCR is to display. Your TV or VCR user guide can tell you how to display the video signal from the 'Video In' jack.

If you don't have the manual for your TV or VCR we suggest calling the TV or VCR manufacturer's customer service department. Only the manufacturer will be able to tell you very quickly how to configure your TV or VCR to display the video signal coming from the 'Video Input' jack.

* Note: Some projection TV sets do not display the standard blue background used on most CDGs properly. If the background color is inconsistent or flashing, please try connecting your Singing Machine to a standard tube television.

COMMON WAYS TO CONFIGURE YOUR TV OR VCR

Your Singing Machine is designed to connect to your TV the same way you would connect a video camera, VCR or video game. The Singing Machine is constantly sending the video and audio signals to the 'Video Out' and 'AUX OUT' jacks whenever you play a CDG. So, load a CDG into your Singing Machine before you start making these connections. You will see lyrics on the TV screen as soon as you complete the setup completed correctly.

We refer to TV/VCR because manufacturers use very similar ways to connect TVs and VCRs and you can connect your Singing Machine to a TV, VCR or satellite system. The setup of your TV/VCR is the most difficult part of making the connection for displaying your Singing Machine lyrics. In most homes, the TV has either a cable connected or antennae in use. Once you connect your Singing Machine to the TV/VCR, choose the correct input on your TV/VCR to display lyrics from The Singing Machine instead of the usual input from the cable or antennae.

Check your TV/VCR user manual for the easiest way to setup your particular entertainment system. If you don't have your manual you can always contact your TV/VCR manufacturer for information either by phone or by viewing their website for online assistance. We've listed below the most common ways of setting up a TV/VCR:

- (1) In the setup menu for configuring the TV/VCR there may be an option on 'Input Selection' where you may choose between 'Cable/Ant.', 'Video 1', or 'Video 2' etc. as the input source.
- (2) Try looking for a 'Video' channel between the highest channel and the lowest channel on your TV or VCR. (i.e. Between 99 and 2 may be 'VIDEO' or 'INPUT' or 'GAME')
- (3) Look for a button on the remote control for the TV/VCR you are connecting to that says 'VIDEO', 'VIDEO 1', 'Game', 'AUX', 'EXT', 'LINE1', 'LINE-IN' or occasionally the 'VCR' button will display the Video input source.

MAKING THE CONNECTIONS

CONNECTING A VIDEO COMPONENT FOR INPUT

Please follow the steps below to display CDG lyrics on the Singing Machine's monitor from another video source:

- (1) Locate the multicolored patch cords.
- (2) Connect video cable (yellow) to the Video In on the back of the Singing Machine.
- (3) Connect the other end of the Video Cable (yellow) to the Video Output on another video source such as a VCR.
- (4) Set the FUNCTION Selector switch to AUX and the MONITOR Selector switch to CDG/AUX.
- (5) Adjust the BRIGHTNESS, CONTRAST and VERTICAL HOLD Controls at the back of the Singing Machine to have the best picture quality.

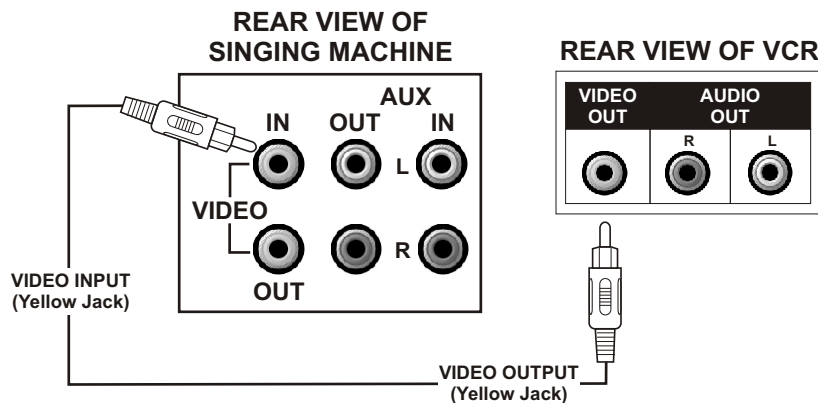

AUDIO CONNECTION

Connect the unit to your TV or home stereo system using the White and Red connections on the supplied patch cord. Plug the white end of the patch cord into the white AUX OUT jack on the unit. Plug the red end of the patch cord into the red AUX OUT jack on unit. Now connect the other end of the cable's white (left channel) and red (right channel) plugs to your TV or home stereo system's 'AUDIO IN' or 'AUX IN' jacks.

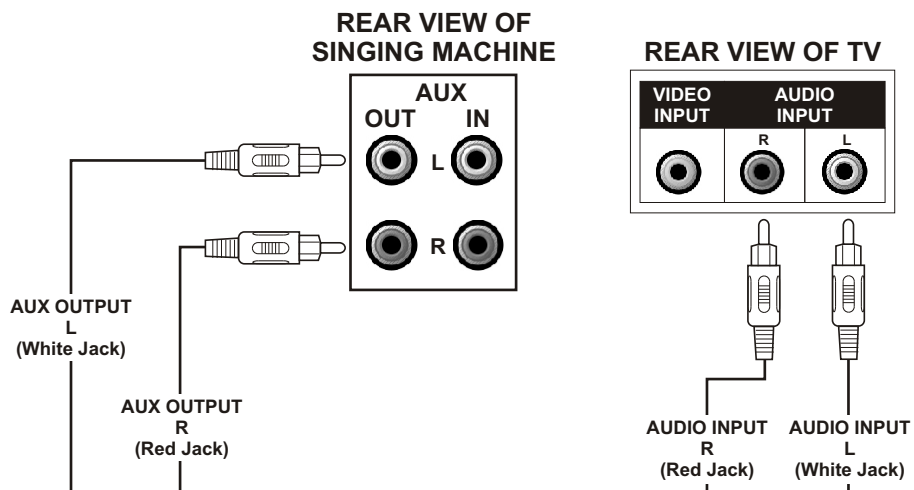

MAKING THE CONNECTIONS

CONNECTING AN AUDIO COMPONENT FOR INPUT

To connect another audio source (such as a Tuner, an AV Receiver or a VCR) so you can sing along with its music, simply connect the Audio Output jacks (Red & White RCA jacks) to the Singing Machine's AUX IN L & R jacks.

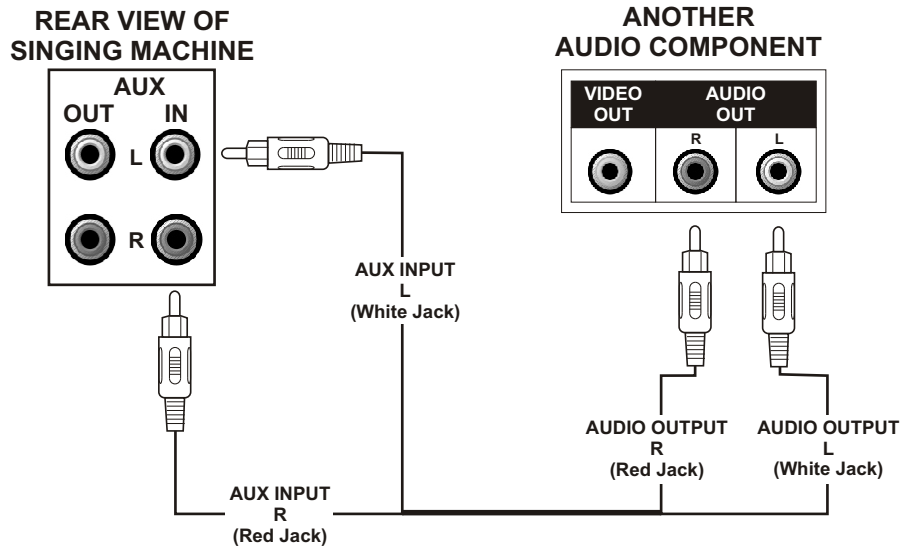

ANTENNA CONNECTION

1. ROD ANTENNA (75 OHM)
In a normal reception area, the built-in Rod Antenna will deliver a sharp clear picture. When operating, extend its length and adjust its direction & angle for the clearest picture.
2. External antenna adaptor (PAD).

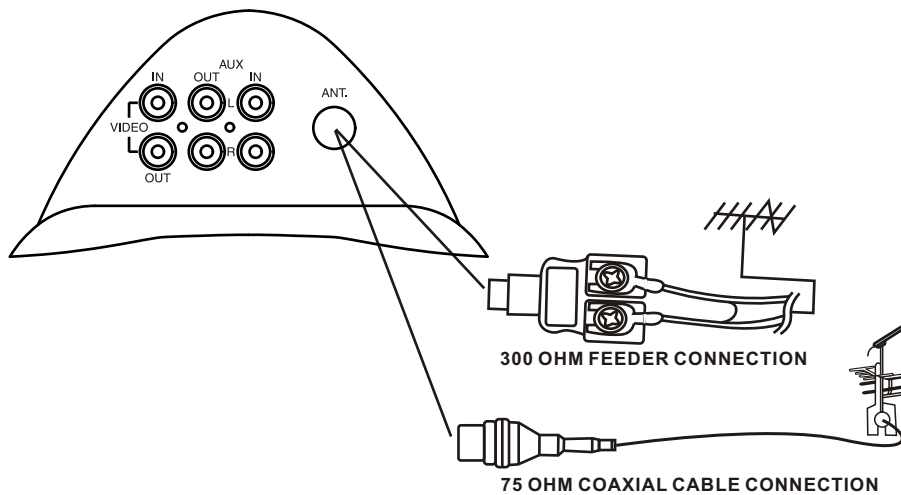

MAKING THE CONNECTIONS

MONITOR Selector

- To display image on the monitor from another video source, set the MONITOR Selector to CDG/AUX mode and set the FUNCTION Selector to AUX mode.
- To display CDG lyrics on the Singing Machine's monitor, set the MONITOR Selector and FUNCTION Selector to CDG mode.
- To display your image on the Singing Machine's monitor, set the MONITOR Selector to CAMERA mode.
- To turn off the monitor on the Singing Machine, set the MONITOR Selector to OFF mode.
- Adjust the BRIGHTNESS, CONTRAST and VERTICAL HOLD controls at the back of the Singing Machine to have the best picture quality.

VIDEO OUT Selector

- To display your image on to another component, set the VIDEO OUT Selector to CAMERA mode.
- To display CDG lyrics on another component, set the VIDEO OUT Selector and FUNCTION Selector to CDG mode.
- To display image on another component, set the VIDEO OUT Selector and FUNCTION Selector to AUX mode.

CD OR CD+G OPERATION

- * **Warning - Tapping or dropping the microphone while it is on can permanently damage your microphone. Resist the urge to swing the microphone around by the cord!**

PREPARATION

- This unit is designed to play CD's bearing the identification logo "  ". If CD's do not conform to the CD standard, they may not play properly.
- Fingerprints and dust should be carefully wiped off with a soft cloth. Wipe in a straight motion from the center of the disc to the outside edge.
- Never use chemicals, such as record cleaning sprays, antistatic sprays or fluids, benzene or thinner to clean compact discs. These chemicals will permanently damage the plastic surface of the disc.
- Always place the compact disc on the disc tray with the label facing upward. Compact discs can be played on only one side.
- To remove a disc from its storage case, press down on the center of the case and lift the disc out, holding it carefully by the edges.
- Discs should be returned to their cases after use to protect them from dust and scratches.
- To prevent warping the disc, do not expose it to direct sunlight, high humidity or high temperatures for extended periods of time.
- Do not apply paper or write anything on either side of the disc. The inks used in some felt-tip pens may damage the surface of the disc.

PLAYING CD OR CD+G DISC

Reminders:

- Adjust MASTER VOLUME control on your unit, TV or audio system to a comfortable level.
- Adjust MIC/ECHO/BALANCE controls as needed to achieve the desired mix of music and vocals through your TV or sound system.
- Never place anything on top of the Singing Machine. Foreign objects can damage the unit.
- Only place one disc in the CD compartment at a time.

TURNING POWER ON/OFF

- To turn on the Karaoke center, press the ON/OFF button, the ON/OFF LED will light up.
- To turn off the system, press the ON/OFF button again, the ON/OFF LED will turn off.

FUNCTION SELECT

Set the FUNCTION Selector to CDG.

LOADING A DISC

- Open the CD compartment door. Place a disc in the compartment with the printed side facing toward you.
- Gently close the CD door to the CD/CDG compartment. After a few seconds, the LED will display the total number of tracks. (If no disc is loaded, it will display " - - ".)

(Refer to the Trouble Shooting Guide on page E16 if a disc is loaded but the total tracks do not appear.)

CD OR CD+G OPERATION

PLAY/PAUSE MODE

- To start playing, press the PLAY/PAUSE button. The first track [1] and the PLAY/PAUSE LED will be lit.
- To temporarily stop playing, press the PLAY/PAUSE button. The PLAY/PAUSE LED Indicator will flash.
- To resume play, press this button again.

NOTE: Pressing pause when a CDG is playing may cause distorted lyrics on the monitor. Any distortion will remain until the whole screen is refreshed during an instrumental break or you stop the song and start it from the beginning.

STOP MODE

If the STOP button is pressed in the course of playing, the disc will cease to play. (The total number of tracks will be shown on the LED window).

SKIP PLAY(FOR BOTH CD AND CDG DISCS)

- During STOP mode, you can skip up or down to your desired track number by pressing a SKIP button (◀◀-SKIP-▶▶).
- To resume playing the selected song, press PLAY/PAUSE button.

SEARCH (FOR AUDIO CD DISC ONLY)

When playing any audio CD, press and hold the SKIP button (◀◀-SKIP- ▶▶). The CD will search at high speed in the forward or backward direction. Normal play will continue when you release the button.

REPEAT

- To repeat the track currently playing, press the REPEAT button once. The REPEAT LED will start to flash.
- To repeat all tracks, press the REPEAT button twice. The REPEAT LED will light up and stay lit.
- To clear the repeat function. Press the REPEAT button again. The REPEAT LED will turn off.

PROGRAM

- Use this button to program and play back songs in a preselected order.
 - Step 1: Programming should be done in the stop mode only. Press the PROGRAM key until the PROGRAM LED flashes, the track will read [0].
 - Step 2: Press the double arrow keys (◀◀-SKIP- ▶▶) to select a desired track.
 - Step 3: Press PROGRAM key to confirm entry. You can repeat the same steps up to a maximum of 20 tracks.
 - Step 4: Press PLAY to activate PROGRAM.
- Press the STOP button to clear all the programmed entries.

MONITOR (FOR CDG ONLY)

- Set MONITOR Selector to CDG if you want to display CDG lyrics on the Singing Machine's monitor.

TV OPERATIONS

TV BROADCASTING RECEPTION

1. Press the ON/OFF button.
2. Switch FUNCTION Selector to TV/RADIO position.
3. Switch MONITOR Selector to TV position.
4. Turn TUNING knob to select desired TV channel with UHF/VH/VL channel selector.
5. For the best signal, connect the unit to an aerial antenna using the external antenna jack or use the directional antenna on the back of the unit.
6. Adjust BRIGHTNESS, CONTRAST and VERTICAL HOLD volume to have the best picture quality.
7. Adjust MASTER VOLUME to your pleasure.
8. To turn the TV off, set FUNCTION Selector to CDG or AUX position.

RADIO OPERATIONS

AM/FM RADIO

1. Press the ON/OFF button.
2. Switch FUNCTION Selector to RADIO position.
3. Switch BAND selector to either AM, FM or FM (ST.) radio position.
4. For FM or FM (ST.) reception, use directional antenna on back of unit for best signal. (AM antenna is built-in).
5. Turn tuning knob to select desired station as indicated on dial.
6. Adjust MASTER VOLUME to your pleasure.
7. To turn the radio off, set FUNCTION Selector to CDG or AUX position.

Note: Echo effect cannot be activated in radio mode.

CARE AND MAINTENANCE

POWER SWITCH

After using the unit, turn off the power by pressing the ON/OFF button.

CLEANING THE UNIT

To clean the exterior of the unit, simply wipe with a soft clean cloth moistened with plain lukewarm water.

CLEANING THE CD LASER LENS

For the Best Results: Use a CD-lens cleaning disc according to the cleaning disc manufacturer instructions.

If a lens cleaning disc is not available, use a clean, soft, dry cotton cloth to gently wipe the small, glass, fish-eye laser lens located in the CD players.



To prevent fire or shock hazard, disconnect your stereo system from the AC power plug when cleaning.

COMPACT DISC

Handling Disc

Although the music tracks on the disc are covered with a protective layer, it is still advisable to treat the disc carefully. Ensure that you always pick up discs by the edge, and put them back in their holders immediately after use.

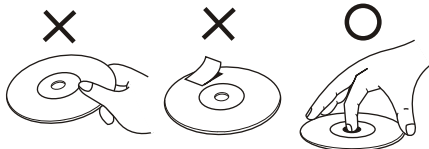

CLEANING DISC

Cleaning will not normally be necessary. However, should fingerprints, dust or dirt appear, you can wipe them off with a soft, lint-free cloth. Wipe the disc in a straight line from center to edge. You can moisten the disc first with ordinary tap water if necessary.



NOTE: Do not use detergent or abrasive cleaning agents as they can damage the disc.

CD PLAYER

The player mechanism is fitted with self-lubricating bearings and must not be oiled or greased.

TROUBLE SHOOTING GUIDE

If you have followed the instructions and are having difficulty operating the unit, locate the PROBLEM in the left column below. Check the corresponding POSSIBLE CAUSE column to locate and remedy the problem.

| PROBLEM | POSSIBLE CAUSE | SOLUTION |
|---|---|--|
| No power when POWER is on. | No power plug connection at the AC outlet. | Insert the power plug into the AC outlet. |
| No power when plugged in. | The AC outlet may not have power. | Check the outlet with a working lamp or other electrical appliance. |
| No sound. | Volume control is set to minimum. | Turn up the volume. |
| No sound from TV/PA. | The wrong function is selected. | Select the correct function. |
| | Volume control on TV set/PA system is set to minimum. | Turn up the volume at TV set/PA system. |
| | TV set/PA system power is OFF. | Turn on the power at TV set/PA system. |
| | Patch cords are not secure. | Ensure white and red patch cords are securely inserted into both The Singing Machine and the TV/PA system. |
| CD PLAYER cannot work normally or "E", "E", or "E" are displayed. | Disc is inserted upside down. | Insert disc correctly. |
| | Disc is dirty. | Wipe clean with soft cloth. |
| | Disc is scratched. | Use a new disc. |
| | Disc is warped. | Use a new disc. |
| | A nonstandard disc is inserted. | Only use discs bearing standard logo as described on page E12. |
| | Moisture has formed inside the CD deck. | Wait about 20 to 30 minutes to let it dry out. |
| | Singing Machine needs to be reset. | Disconnect the machine from power source for 30 seconds. |

TROUBLE SHOOTING GUIDE

| PROBLEM | POSSIBLE CAUSE | SOLUTION |
|--|---|---|
| No sound - If audio is connected to TV or VCR. | Source Selection on TV or VCR is not correct. | Follow directions on page E7 for "Making the Connections". |
| | Patch cords are not connected securely. | Ensure white and red patch cords are securely inserted into both The Singing Machine and the TV/VCR. |
| No song lyrics appear on screen. | Video cable is not connected properly to the TV. | Connect the video cable to the Singing Machine's VIDEO OUT and to the TV VIDEO IN. |
| | Source selector on TV is not set to VIDEO. | Using your TV remote to select VIDEO input. |
| | TV does not have video line input. | Connect from VIDEO OUT of the system to the VIDEO IN of your VCR or connect to an RF Modulator and then to the TV cable input. Refer to "Making the Connections" on page E7. Check the disc to be sure it is a CDG. (See page E20 for details.) |
| | A CDG is loaded but the CDG indicator is not lit. | Check disc to be sure it is clean. (See page E15 for cleaning instructions.) |
| | Source selector on TV is not set to VIDEO. | Use your TV remote to select VIDEO input. (Refer to page E8 under Common ways to configure your TV or VCR) |
| | Source selector on TV is not set to VIDEO. | Use your TV remote to select the proper VIDEO input or select the proper VIDEO input on the TV itself. (Refer to page E8 under Common ways to configure your TV or VCR) |
| Image is blurry. | Camera has not warmed up. | Wait a minute for the camera to warm up. |
| | Camera lens is dirty. | Clean the camera lens. |
| | Camera lens is out of focus. | Adjust the lens of the camera by slightly rotating either left or right until the display is clear. Do not overturn the lens. |

TROUBLE SHOOTING GUIDE

| PROBLEM | POSSIBLE CAUSE | SOLUTION |
|---|---|--|
| Picture is jumping up. | VERTICAL HOLD Control is not set correctly. | Adjust the VERTICAL HOLD Control. |
| While playing CDG and singing with the microphone, the music or vocal cuts out. | Balance is not adjusted properly. | Adjust balance to mid point. |
| | AVC is activated to Maximum. | Adjust AVC to Minimum. |
| | Playing music only track. | Play track that includes music and vocal. |
| No sound - If audio is connected to home stereo. | Source Selection on your stereo is not set properly. | Select AUX IN as the source for your home stereo. |
| | Improper Connection to stereo system or PA. | Follow direction on page E9 for connecting to a home stereo system. |
| | Patch cords are not secure. | Ensure white and red patch cords are securely inserted into both The Singing Machine and the home stereo system. |
| No image displays on Singing Machine's monitor when attempting to use camera. | MONITOR Selector is not set properly. | Set MONITOR Selector to CAMERA mode. |
| | Brightness knob not adjusted properly on Singing Machine. | Adjust Brightness on Singing Machine. |

SPECIFICATIONS

| | |
|--|--|
| AUDIO SECTION: OUTPUT POWER (MAXIMUM) OUTPUT IMPEDANCE | 2.0 WATTS + 2.0 WATTS (RMS) 8 OHMS |
| CD PLAYER SECTION: FREQUENCY RESPONSE SIGNAL - TO - NOISE RATIO WOW AND FLUTTER D - A CONVERSION NUMBER OF PROGRAMS SAMPLING SYSTEM | 100 Hz - 20 kHz (+/-3 dB) 50 dB (A-WTD) IMMEASURABLE 1-BIT DAC 20 STEPS RANDOM ACCESS PROGRAMMING 8 TIMES OVER SAMPLING |
| TV SECTION: SYSTEM LO VHF CHANNEL HI VHF CHANNEL UHF CHANNEL | NTSC 2-6 7-13 14-83 |
| RADIO SECTION: AM FREQUENCY RANGE FM FREQUENCY RANGE | 530-1710 kHz 88-108 MHz |
| MICROPHONE | -74 dB 600 OHMS IMPEDANCE WITH Ø6.3mm DYNAMIC MICROPHONE |
| POWER SECTION | AC 110V-120V~60Hz |
| DIMENSIONS (H x W x D) | 17.4 x 15.2 x 9 Inches / 44.5 x 38.9 x 23 cm |
| WEIGHT | 8.2 lbs / 3.7 kgs |
| ACCESSORIES | 1. PRE-RECORDED KARAOKE CD+G DISC 2. AV CABLE 3. DYNAMIC MICROPHONE |

Specifications are typical, individual units might vary. They are subject to continuous improvement without notice and without incurring any obligation.

THE SINGING MACHINE KARAOKE GLOSSARY OF TERMS

In addition to all of the terminology associated with consumer electronics products, a few additional terms are used almost exclusively in karaoke. These terms are meant to familiarize you with the world of Karaoke. The features listed below **may not** necessarily pertain to the particular model Singing Machine that you have. The following are some brief explanations of karaoke terms:

Echo:

Echo adds depth and resonance to a singer's voice, without affecting the music. This echo is produced by creating minor controlled feedback in the singer's voice.

Multiplex:

Our multiplex recordings contain 2 copies of the same song. One version is a stereo recording of the song without the lead singer. The second version is recorded with the music and background vocals on the left channel and the lead singer recorded on the right channel. This 'split track' recording allows you to control the volume of the lead singer by adjusting the balance control. You can sing a duet with the lead singer or use the lead singer as a guide as you learn the song, gradually fading them out with the balance control until you are able to sing the song on your own.

Auto Voice Control (A.V.C.):

When the AVC function is activated, the vocals on a multiplex recording are eliminated as soon as the singer begins singing into the microphone. When the singer stops singing, the vocals on the multiplex recording are automatically re-activated. This useful function is used primarily during practice sessions while a singer is learning a song. Please note that the AVC function only works with multiplex recording and not with standard audio recordings.

Pitch Control:

This function controls pitch of music by controlling the speed at which a cassette tape plays back. By increasing the speed of the tape, the music sounds higher (sharp). By slowing the tape speed, the music sounds lower (flat).

Key Controller:

Key Controller changes the key of the CD/CDG music (+ or - steps) to adjust to the singer's voice.

CDG:

This is an acronym for Compact Disc plus Graphics. You will also see variations CD+G, and CD+Graphics. This is a regular audio CD with information stored on a data track simultaneous to music. In laymen's terms, CDG has a video output for simple graphics (not full motion video). In the case of karaoke, the graphics function is used to store song lyrics, and display the lyrics in synch with music. In most cases, CDG software displays lyrics which change color as they are to be sung. A regular television is all that is required to display CDG lyrics.

NOTE - CDG is a particular type of compact disc encoding system that is different from VCD or DVD. Your Singing Machine can decode standard audio compact discs and CDG discs. It will not read VCD or DVD encoded discs.

Standard audio discs and cassette tapes will not display lyrics on your TV. Audio CDs do not contain the software necessary to display lyrics.





The Singing Machine Company, Inc.

989-0411-ENG01

6601 Lyons Road, Bldg. A7, Coconut Creek, FL33073-9902, USA.
TEL: (954) 596-1000 FAX: (954) 596-2000

PRINTED IN CHINA

VISIT OUR WEBSITE www.singingmachine.com

Free Manuals Download Website

<http://myh66.com>

<http://usermanuals.us>

<http://www.somanuals.com>

<http://www.4manuals.cc>

<http://www.manual-lib.com>

<http://www.404manual.com>

<http://www.luxmanual.com>

<http://aubethermostatmanual.com>

Golf course search by state

<http://golfingnear.com>

Email search by domain

<http://emailbydomain.com>

Auto manuals search

<http://auto.somanuals.com>

TV manuals search

<http://tv.somanuals.com>