

# CROSLEY

## Electric Dryer

CDE-8000GW/GR/GS/GBL

### PRODUCT FEATURES

#### **OUTSTANDING PERFORMANCE**

Besides the large capacity, you can benefit from faster drying time, quiet operation, and energy efficiency.

#### **STAINLESS STEEL DRUM**

Stainless steel drum resists rust.

#### **DIGITAL FABRIC CARE**

Multi-Level temperature control takes better care of your clothes.

#### **EASE OF USE**

An entire selection of user-friendly functions make operating the dryer easier.

#### **ADAPTABLE CONTROL**

The control panel can be in the top or bottom position to allow easy access whether side-by-side washer and stack on a pedestal.

#### **ONE TOUCH SELECTIONS**

To choose an option, press its button once. No need to press buttons multiple times to scroll through a list of options.

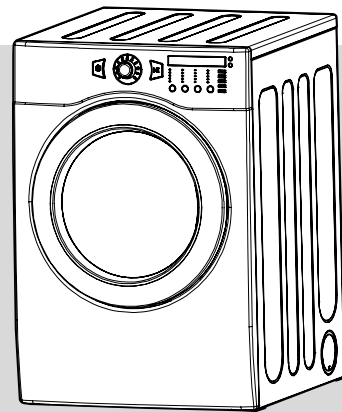

### What are Sensor Dry and Time Dry?

Your dryer provides sensor drying and time drying programs.

#### **Sensor Dry**

The dryer senses the dampness of the laundry and automatically determines the heat level and operation time. You might see a sudden increase or decrease in operation time if the sensor determines more or less drying is required. This is not a malfunction.

#### **Time Dry**

Use TIME DRY to select heat level and drying time manually. This can be used if clothes are not as dry as you like them at the end of the cycle. Use TIME DRY for heavy and bulky items and thick work.

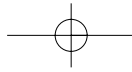

# TABLE OF CONTENTS

PART 1. SPECIFICATIONS .....2

PART 2. IMPORTANT WARRANTY AND SAFETY INSTRUCTIONS .....3

PART 3. INITIAL STEPS FOR INSTALLING YOUR DRYER.....6

PART 4. ACCESSORIES INSTALLATION .....13

PART 5. ELECTRICAL REQUIREMENTS FOR ELECTRIC DRYER .....14

PART 6. USER - MAINTENANCE INSTRUCTIONS .....20

PART 7. OPERATING YOUR DRYER .....22

PART 8. TROUBLESHOOTING GUIDE.....29

DAEWOO DRYER LIMITED WARRANTY.....32

## PART 1 SPECIFICATIONS

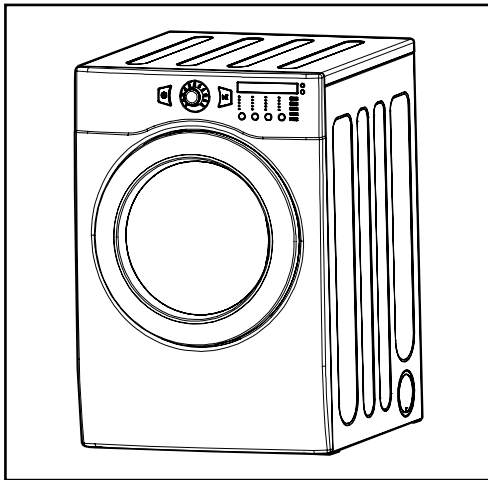

- Type : Electric Dryer
  - Rating : Please refer to the rating label regarding detailed information.
  - Size : 27 x 32.4 x 40.2 inches
  - Capacity : IEC 7.3 cu.ft. (22.9 lb)
  - Weight : 128 lbs (58.5 kg)
- ※ Specifications are subject to change by manufacturer.

### ■ Accessories

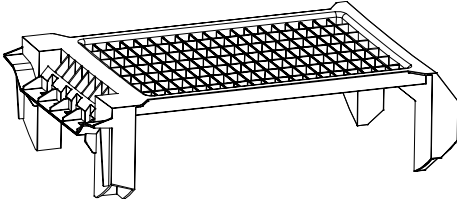
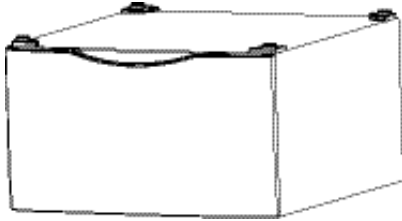
Dryer Rack	Pedestal Purchased Separately
	 <p>※ Design of pedestals is subject to change without manufacturers notice.</p>

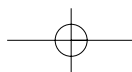

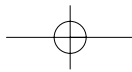

## **PART 2** IMPORTANT WARRANTY AND SAFETY INSTRUCTIONS

### **[SEEKING WARRANTY SERVICE]**

The warranty information for your dryer is located at the end of this manual. Warranty Service is available by contacting the nearest DAEWOO

Service Center. If this product is installed and operated according to the instructions in this manual, DAEWOO will repair or replace any parts defective in material or workmanship throughout the warranty period, beginning with the date of purchase.

#### **! WARNING!**

For your safety, the recommendations in this manual must be followed. To reduce the risk of fire or explosion, electric shock or to prevent property damage, personal injury, or death when using your appliance follow basic precautions.

#### **Warranty Restriction :**

If the dryer is subjected to other than single family use, all warranty coverage is effective for only 90 days.

You will need the complete model and serial number when requesting warranty service. A proof of purchase is also required.

Use the space below to record the model number and serial number of your new DAEWOO dryer.

**Model Number** \_\_\_\_\_

**Serial Number** \_\_\_\_\_

**Date of Purchase** \_\_\_\_\_

※ Staple your receipt here for convenience when contacting service.

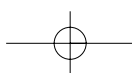

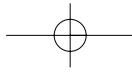

## [IMPORTANT SAFETY INSTRUCTIONS]

### **WARNING!**

To help reduce any risk of electric shock, fire, or other personal injury or property damage when using your Appliance, please exercise care and follow basic safety precautions, including the following:

- 1) Read all instructions before using the appliance.
- 2) Do not dry articles that have been previously cleaned in, washed in, soaked in, or spotted with gasoline, dry-cleaning solvents, or other flammable or explosive substances, as they give off vapours that could ignite or explode.
- 3) Do not allow children to play on or in the appliance. Close supervision of children is necessary when the appliance is used near children.
- 4) Before the appliance is removed from service or discarded, remove the door to the drying compartment.
- 5) Do not reach into the appliance if the drum is moving.
- 6) Do not install or store this appliance where it will be exposed to the weather.
- 7) Do not tamper with controls.
- 8) Do not repair or replace any part of the appliance or attempt any servicing unless specifically recommended in the user-maintenance instructions or in published user-repair instructions that you understand and have the skills to carry out.
- 9) Do not use heat to dry articles containing foam rubber or similarly textured rubber-like materials.
- 10) Clean lint screen before or after each load.
- 11) Keep area around the exhaust opening and adjacent surrounding areas free from the accumulation of lint, dust, and dirt.
- 12) The interior of the appliance and exhaust duct should be cleaned periodically by qualified service personnel.
- 13) Do not place items exposed to cooking oils in your dryer. Items contaminated with cooking oils may contribute to a chemical reaction that could cause a load to catch fire.
- 14) Do not use fabric softners or products to eliminate static unless recommended by the manufacturer of the fabric softner or product.
- 15) This dryer is designed only for residential use.
- 16) Ensure pockets are free from small irregularly shaped hard objects, foreign material, etc. ie. coins, knives,pins, etc. These objects could damage your dryer.
- 17) Do not wash clothing with large buckles, buttons, or other heavy metal or solid decorative things.

## [SAVE THESE INSTRUCTIONS]

### USING INSTRUCTIONS

- 1) Do not overload the drum, that may cause poor drying and wrinkling.
- 2) Do not over dry fabrics such as knitted fabrics and flannel.
- 3) Do not dry items such as elastic bands, plastics, rubberized items, or sneakers that might melt or ignite in the dryer.
- 4) Check the lint filter is in place.
- 5) Make sure the laundry is not caught when the door is closed to prevent fabric damage.
- 6) Check the filter every cycle because a clogged filter causes fire hazardous condition and affects the dryer efficiency.
- 7) When cleaning the surface of the drum, you should use a non-abrasive stainless steel cleaner.
- 8) To prevent a short circuit or penetrating moisture, make sure the lamp cover is firmly closed.
- 9) Do not sit on top of the dryer.

**NOTE:** Because of continuing product improvements, Daewoo reserves the right to change specifications without notice. For complete details, see the Installation Instructions packed with your product before selecting cabinetry, making cutouts, or beginning installation.

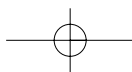

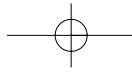

---

## [GROUNDING INSTRUCTIONS]

### **A. For a grounded, cord-connected appliance:**

This appliance must be grounded. In the event of malfunction or breakdown, grounding will reduce the risk of electric shock by providing a path of least resistance for electric current.

This appliance must be equipped with a cord having an equipment-grounding conductor and a grounding plug. The plug must be plugged into an appropriate outlet that is properly installed and grounded in accordance with all local codes and ordinances.

#### **WARNING!**

Improper connection of the equipment grounding conductor can result in a risk of electric shock. Check with a qualified electrician or service representative or personnel if you are in doubt as to whether the appliance is properly grounded.

Do not modify the plug provided with the appliance. If it will not fit the outlet, have a proper outlet installed by a qualified electrician.

### **B. For a permanently connected appliance:**

This appliance must be connected to a grounded metal, permanent wiring system; or an equipment-grounding conductor must be run with the circuit conductors and connected to the equipment-grounding terminal or lead on the appliance.

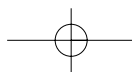

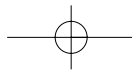

## PART 3 INITIAL STEPS FOR INSTALLING YOUR DRYER

The following instructions will guide you through the initial steps of setting up your dryer. Please note that every section of this manual provides important information regarding the preparation and use of your dryer, and it is important that you review this entire manual before proceeding with any installation or use. More detailed instructions concerning electrical connections, gas connections, and exhaust requirements are provided in other parts of this manual.

### STEP 1. Positioning the Dryer.

Choose a location with a solid floor for your dryer. Place the dryer in the desired location and make sure that it has the required clearances shown below.

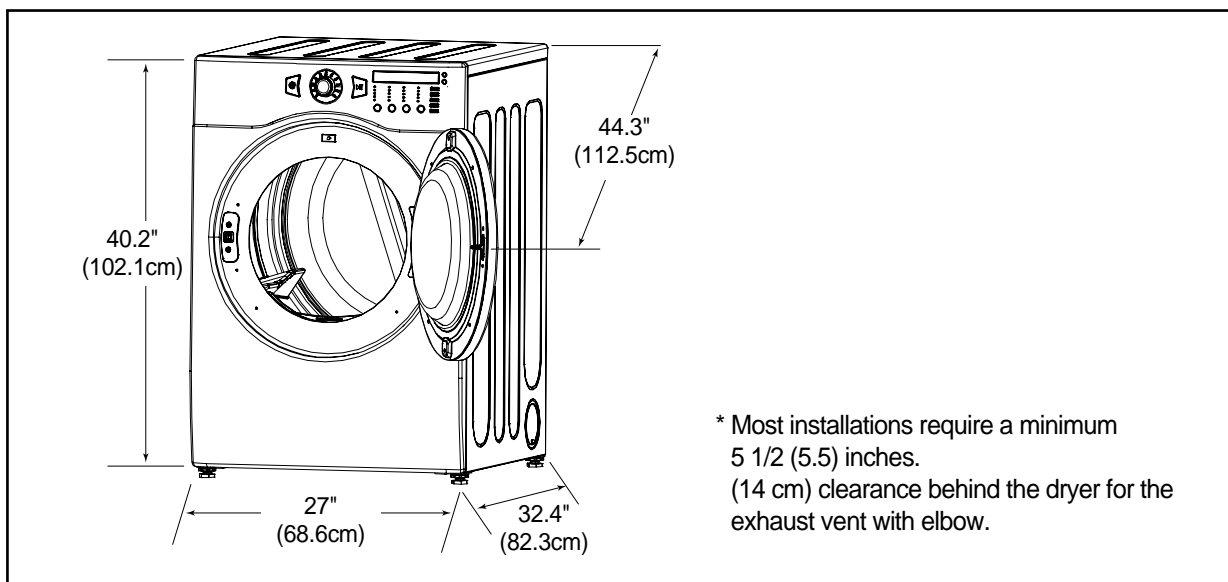

#### NOTE:

Leveling legs should be secured.  
All four legs should be stably placed on a solid and even floor.  
If dryer is not level, laundry may not tumble properly and sensor will not detect humidity information accurately.  
When leveling, please be cautious not to injure your fingers and toes.  
If you install the dryer on the optional pedestal, it is necessary to level with the pedestal leveling legs.

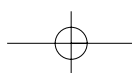

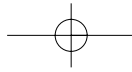

### Minimum clearances on above, behind, and sides of the unit, as shown below, are required.

Those required minimum clearances are set forth in the picture below. Please keep the following instructions in mind when installing in a closet or recessed area:

- Consider allowing additional clearance for installation and servicing.
- Wall, door and floor molding may necessitate additional clearances.
- Additional inches of clearance are recommended to reduce noise while operating.
- Consider the space needed for companion appliances.
- For closet installations, the picture below shows the minimum required ventilation openings for the door. A louvered door with comparable ventilation openings is also acceptable.

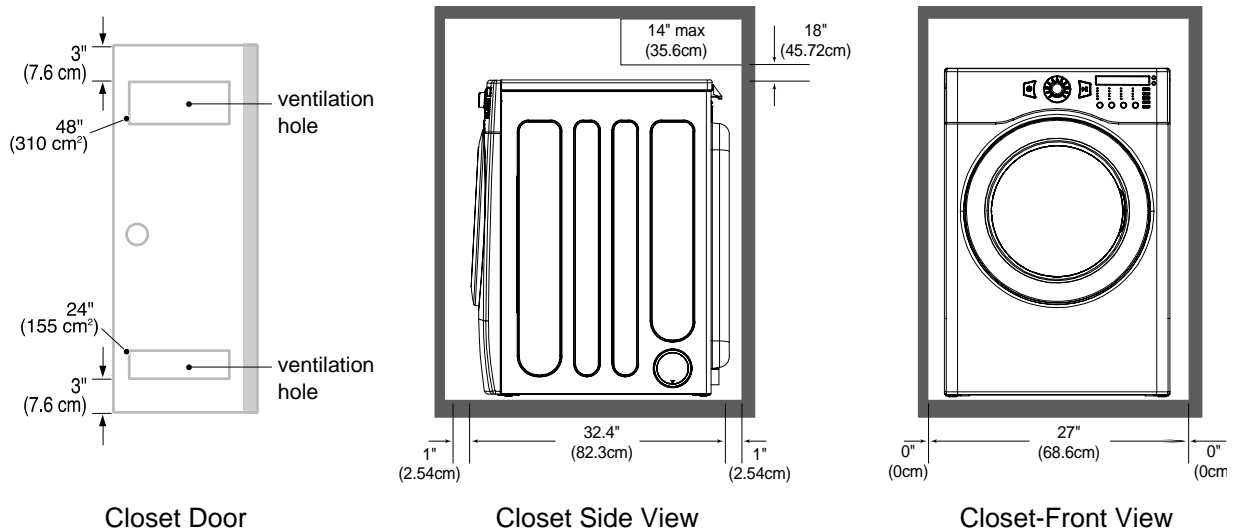

Once in position, adjust the leveling legs of the dryer until it is level from left to right and front to back. The leveling legs must remain firmly on the floor and the dryer should not rock. The maximum slope of the dryer from left to right or front to back should not exceed 2.5 cm (1 inch). If the dryer is not level, and if the slope exceeds 2.5 cm (1 inch), a load may not tumble properly and internal sensors may malfunction.

#### NOTE:

Other sections of this manual also provide important information concerning the placement of and clearances for your dryer.

Please review this entire manual before proceeding with any installation.

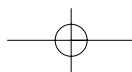

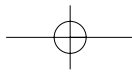

## STEP 2. Connecting the Exhaust System

### **⚠ WARNING!**

- To reduce the risk of fire this appliance **MUST BE EXHAUSTED OUTDOORS**.
- The appliance should not be exhausted into a chimney, a wall, a ceiling, or a concealed space of a building.
- Only rigid or flexible metal duct should be used, for exhausting.
- Do not use plastic or thin foil duct.
- Failure to follow these instructions can result in death or fire.
- Clean old ducts before installing this dryer.

### **⚠ WARNING!**

The exhaust must be vented to the outside.  
Improper taping and incorrect installation will cause dryer malfunction.

In addition to the following warnings, please refer to manual section on Exhaust Requirements and Maintenance.

**IMPORTANT:** To reduce the risk of fire, combustion, and gas accumulation, the dryer must be vented to the outdoors. Please follow the instructions (and all others in this manual) very carefully.

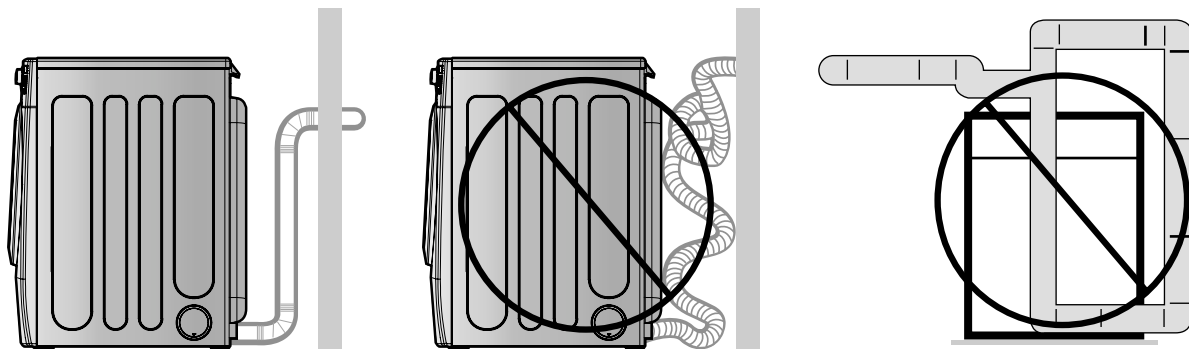

- Do not use plastic or thin foil duct.
- Use 4" (10.2 cm) diameter rigid or semi-rigid metal duct (NOTE! Venting materials are not supplied with the dryer, and you should obtain the venting materials necessary for proper installation)
- Position the dryer such that the exhaust duct run is as short as possible.

### **Clean old ducts before installing this dryer**

- The male end of each section of exhaust duct must point away from the dryer.
- Use as few elbow joints as possible.
- Use duct tape on all duct joints.
- Insulate ductwork that runs through unheated areas in order to reduce condensation and lint build-up on pipe walls.

**PLEASE BE AWARE THAT FAILURE TO EXHAUST THE DRYER CORRECTLY WILL VOID THE DRYER'S WARRANTY.**

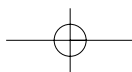



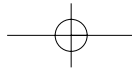

## ■ ALTERNATE EXHAUST DIRECTIONS

### 1. Remove screw and exhaust duct.

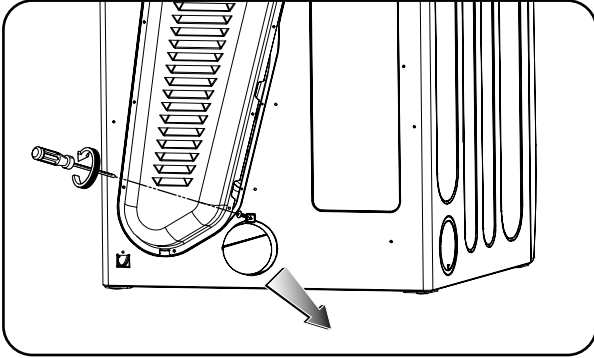

### 2-1. Detach and remove the knockout that matches the desired venting direction

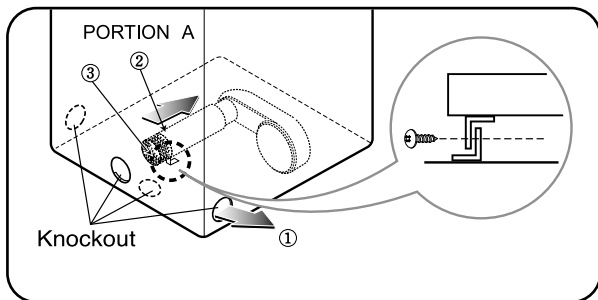

### 2-2. Reconnect the new duct[8.66 inch(22cm)] to the blower housing, and fixing the duct to the base.

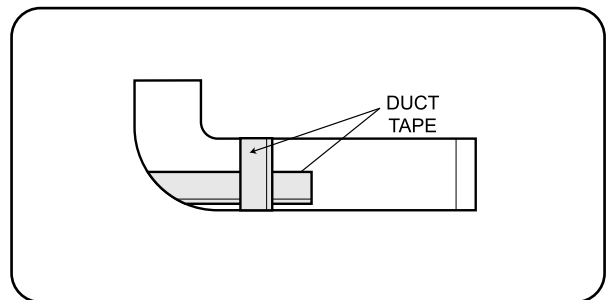

### 3-1. Insert the male end of a 4" elbow into the female end of a short duct. Tape the joint.

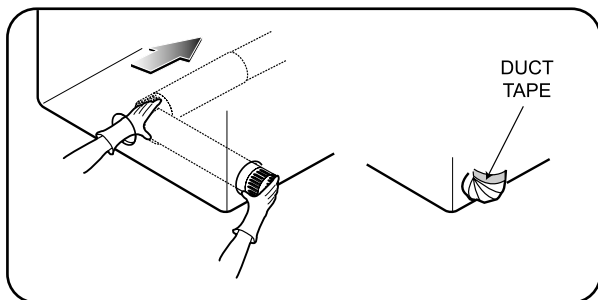

### 3-2. Insert this assembly elbow first through the hole in the dryer and push the female end of the elbow onto the male end of the blower output shaft. Tape the joint.

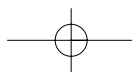
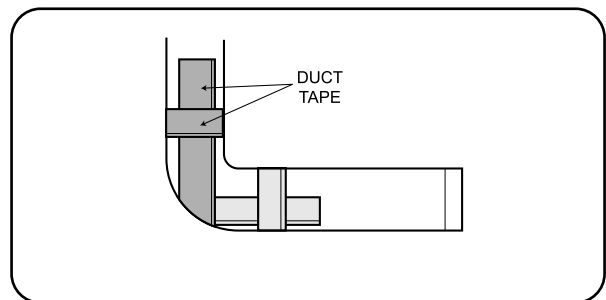

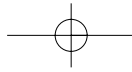

## STEP 3. Electrical Plug Connections

Following steps are several warnings and instructions concerning making the electrical connection for electric dryers.

More detailed information concerning the electrical connection is provided in the manual section entitled Electrical Requirements for Electric Dryer.

It is important that you thoroughly review that section and the remainder of this manual, before taking any steps to install or use this dryer.

1. Use only a new UL listed No. 10 (copper wire only) three or four conductor power supply cord kit rated 240 Volts (minimum) 30 Amperes and labeled as suitable for use in a clothes dryer.
2. A four-wire cord is required for manufactured (mobile) home installations and where local codes do not allow grounding of this appliance through neutral.
3. Electrical Plug Connections.
4. For additional instruction on connecting the dryer to an electrical power source, please refer to this manual's section on Electrical Requirements and Electric Dryer.

### **WARNING!**

- Use a new UL listed 30 amp power supply cord.
- Use a UL approved strain relief.
- Disconnect power before making electrical connections.
- Connect neutral wire (white or center wire) to center terminal.
- Ground wire (green or bare wire) must be connected to green ground connector.
- Securely tighten all electrical connections
- See installation instructions for complete instructions.
- Failure to do so may result in fire or electrical shock.

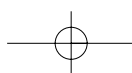

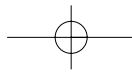

## STEP 4. Preparation of the Dryer

Prior to the first use of this appliance, use all purpose cleaning products or a solution of detergent and water, with damp cloth to remove from the inside of the dryer drum/drying compartment any dust or dirt that may have accumulated inside the dryer.

Plug-in your dryer after reviewing the following parts on your dryer's Electrical Requirements.

## STEP 5. Confirming Heat Source Operation

### Confirming Heat Source in Electric Dryers

Close the door to the dryer drum/drying compartment and, after completing all steps in this manual for proper installation of this dryer, start the dryer on a heat setting.

The exhaust air or the exhaust pipe should be warm after the dryer has been operating for three minutes.

## STEP 6. Dryer Airflow

Effective dryer operation requires appropriate dryer airflow.

The adequacy of the airflow can be measured by evaluating the static pressure.

Static pressure in the exhaust duct can be measured with a manometer, placed on the exhaust duct approximately 1 ft. (30.5cm) from the final outlet.

Static pressure in the exhaust duct should not exceed 7.6mm water column.

The dryer should be checked while the dryer is running with no load.

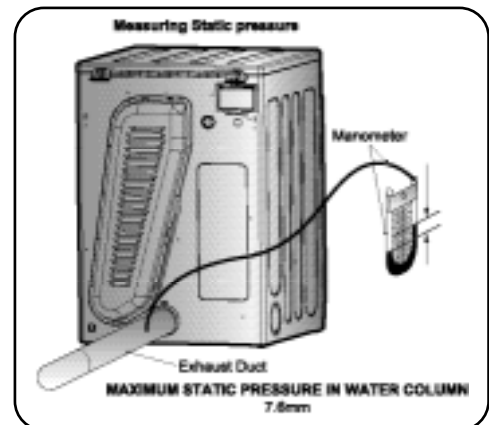

## STEP 7. Procedure for Reversing the Door

The door on your dryer can be installed to open either to the left or the right. Follow these instructions to reverse the direction in which your door opens:

**Note : Door and latch should be aligned at the center when closed.**

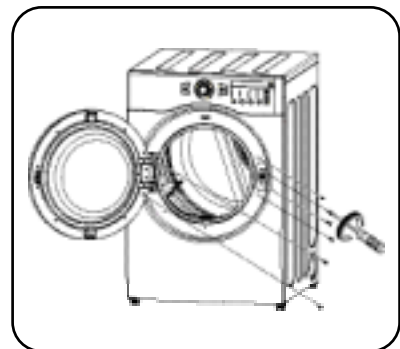
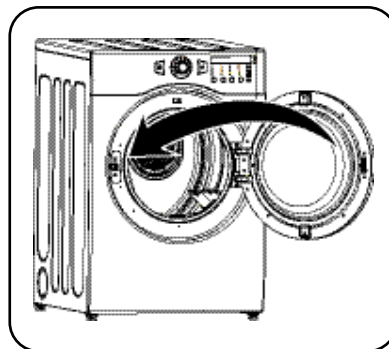
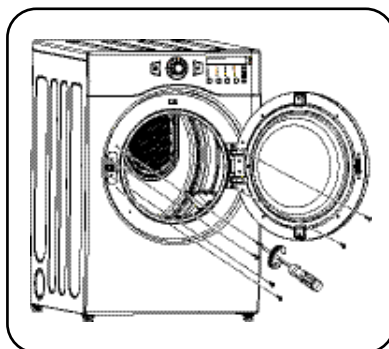

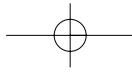

## STEP 8. Additional Instructions for Installation of Your Dryer in a Manufactured or Mobile Home.

The following instructions are applicable to installations of the dryer in a manufactured or mobile home. Any installation in a manufactured or mobile home must comply with the Manufactured Home Construction and Safety Standards and local codes and ordinances.

If you are uncertain whether your proposed installation will comply with these standards, please contact a service and installation professional for assistance.

### The following instructions apply to any installation of the dryer in a manufactured or mobile home:

- 1) The electrical connection for an electric dryer must be a 4-wire connection. More detailed information concerning the electrical connection is provided at the manual section entitled Electrical Requirements for Electric Dryer
- 2) To reduce the risk of combustion and fire, the dryer must be vented to the outside.
- 3) Electric dryers may be vented to the outside using the back, left, right, or bottom panel.
- 4) The dryer exhaust duct must be affixed securely to the manufactured or mobile home structure, the exhaust duct must be made of a material that will resist fire and combustion, and it is recommended that you use a rigid or flexible metal pipe.
- 5) DO NOT connect the exhaust duct with any other exhaust duct, vent, or chimney.
- 6) Make sure the dryer has adequate access to outside fresh air to ensure proper operation.  
The opening for outside fresh air must be at least 25 in<sup>2</sup> (163 cm<sup>2</sup>).
- 7) It is important that the clearance of the duct from any combustible construction be at least 2 inches (5 cm), and, when venting the dryer to the outdoors, the dryer can be installed with a clearance of 1 inch at the sides and back of the dryer.
- 8) Please be aware that venting materials are not supplied with the dryer.  
You should obtain the venting materials necessary for proper installation.

### **WARNING!**

DO NOT connect exhaust ducts with metal screws or fasteners that extend into the duct.  
DO NOT vent the exhaust duct under the manufactured or mobile home.

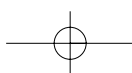

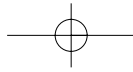

## PART 4 ACCESSORIES INSTALLATION

### Stacking Kit Installation Instructions(DRYER & PEDESTAL)

To ensure safe and secure installation, please observe the instructions below.

#### **⚠ WARNING!**

Incorrect Installation can cause serious accidents.

The weight of the dryer and the height of installation makes the stacking procedure too risky for one person.

This procedure should be performed by 2 or more experienced service personnel.

- 1) Remove pedestal, installation hardware, and instructions are in the shipping carton.
- 2) Position dryer on top of the pedestal.

#### **NOTE:**

Because of the weight of the dryer two or more people may be needed.

If dryer was previously installed, uninstall it as follows

Refer to pedestal installation manual. (Pedestal Model : DWP-W15)

#### **Uninstalling an electric dryer:**

- ① Unplug the power supply cord,
- ② Pull the dryer away from the wall enough to loosen the vent clamp.  
Loosen the clamp and carefully remove the exhaust vent from the dryer exhaust outlet.

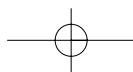
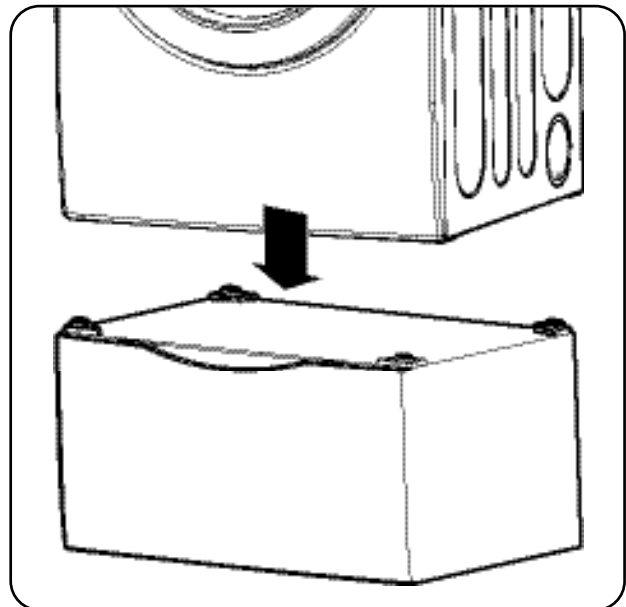

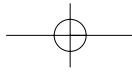

## PART 5 ELECTRICAL REQUIREMENTS FOR ELECTRIC DRYERS

The following are additional instructions regarding electrical connections and requirements for electric dryers.

### Important Warning

To help prevent fire, electric shock, serious injury or death, the wiring and grounding must conform to the latest edition of the National Electrical Code, ANSI/NFPA 70 and all applicable local regulations.

Please contact a qualified electrician to check your home's wiring and fuses to ensure that your home has adequate electrical power to operate the dryer.

### 120V/ 240V, 60 Hertz, 3-Wire Installation

#### Instructions for Grounding of your Electric Dryer:

- a) This dryer must be connected to a grounded metal, permanent wiring system or an equipment-grounding conductor must be run with the circuit conductors and connected to the equipment-grounding terminal or lead on the dryer.
- b) The dryer has its own terminal block that must be connected to a separate 60 Hertz single phase AC circuit, fused at 30 Amperes  
(the circuit must be fused on both sides of the line).

ELECTRICAL SERVICE FOR THE DRYER SHOULD BE OF MAXIMUM RATE VOLTAGE LISTED ON THE NAMEPLATE.

DO NOT CONNECT DRYER TO 110, 115, OR 120 VOLT CIRCUIT.

- c) If branch circuit to dryer is fifteen feet (4.50 m) or less in length, use U.L. (Underwriters Laboratories) listed No. 10 A.W.G. wire (copper wire only), or as required by local codes.  
If over fifteen feet (4.50 m), use U.L. (Underwriters Laboratories) listed No. 8 A.W.G. wire (copper wire only), or as required by local codes.  
Allow sufficient slack in wiring so dryer can be moved from its normal location when necessary.
- d) The power cord (pigtail) connection between wall receptacle and dryer terminal block IS NOT supplied with dryer.  
Type of pigtail and gauge of wire must conform to local codes and with instructions mentioned on the following pages.
- e) The method of wiring the dryer is optional and subject to local code requirements. Refer to examples on next page.
- f) You must select the method by which to wire your dryer according to local code and ordinance requirements.  
Sample methods are included in the following pages.

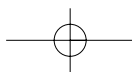

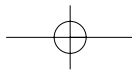



**Review the following options to determine the appropriate electrical connection for your home:**

Use the instructions in this section if your home has a 4-wire receptacle (NEMA type 14-30R) and you will be using a UL listed, 120/240 volt minimum, 30 amp, dryer power supply cord.

Use the instructions in this section if your home has a 3-wire receptacle (NEMA type 10-30R) and you will be using a UL listed, 120/240 volt minimum, 30 amp, dryer power supply cord.



**4-wire receptacle  
(NEMA type 14-30R)**



**3-wire receptacle  
(NEMA type 10-30R)**

If this type is available at your home, you will be connecting to a fused disconnect or circuit breaker box.

If this type is available at your home, you will be connecting to a fused disconnect or circuit breaker box.



**4-wire direct**

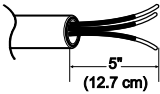

**3-wire direct**

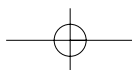

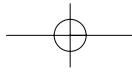

## 4-wire connection : Direct wire

**Important :** Grounding through the neutral conductor is prohibited for (1) new branch-circuit installations, (2) mobile homes, (3) recreational vehicles, and (4) areas where local codes prohibit grounding through the neutral conductor. Prepare minimum 5 ft (1.52 m) of length in order for dryer to be replaced. First, peel 5 inches (12.7 cm) of covering material from end. Strip 5 inches of ground wire insulation. After cutting 1 1/2 inch (3.8 cm) from 3 other wires peel insulation back 1 inch (2.5 cm). Make ends of 3 wires a hook shape.

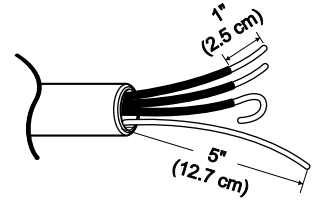

Then, put the hooked shape end of the wire under the screw of the terminal block (hooked end facing to the right) and pinch the hook together and screw tightly.

1. Connect neutral wire (white) of power cord to center terminal block screw.
2. Connect red and black wires to the left and right terminal block screws.
3. Connect ground wire (green) of power cord to external ground screw and move neutral ground wire of appliance and connect it to center screw.
4. Make sure that the strain relief screw is tightened.

Be sure that all terminal block nuts are on tight and power cord is in right position.

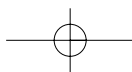
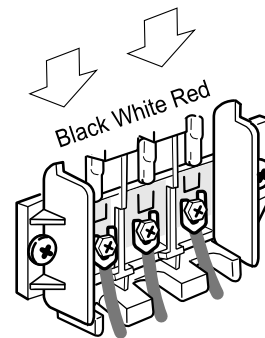
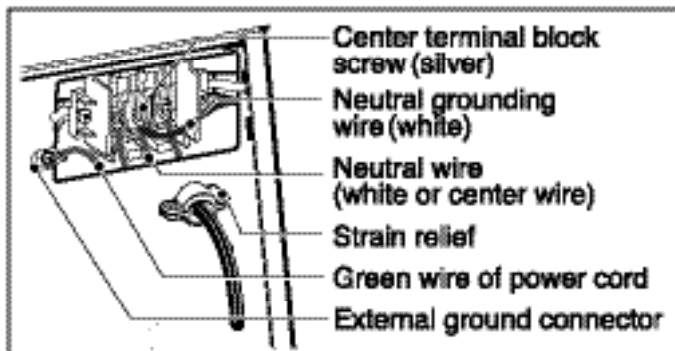



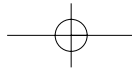

### 3-wire connection : Direct wire

**Important :** Grounding through the neutral conductor is prohibited for (1) new branch-circuit installations, (2) mobile homes, (3) recreational vehicles, and (4) areas where local codes prohibit grounding through the neutral conductor. Prepare minimum 5 ft (1.52 m) of length in order for dryer to be replaced. First, strip 3 1/2 inches (8.9 cm) of outer sheath from end and strip 1 inch of insulation from each conductor.

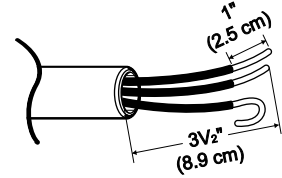

Then, put the hooked shape end of the wire under the screw of the terminal block (hooked end facing rightward) and pinch the hook together and tighten the screw securely.

1. Connect neutral wire (white) of power cord to center terminal block screw.
2. Connect red and black wires to the left and right terminal block screws.
3. Make sure that the strain relief screw is tightened.

Be sure that all terminal block nuts are on tight and power cord is in right position.

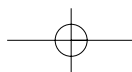
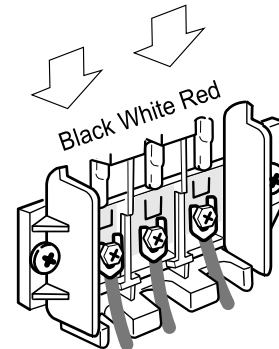
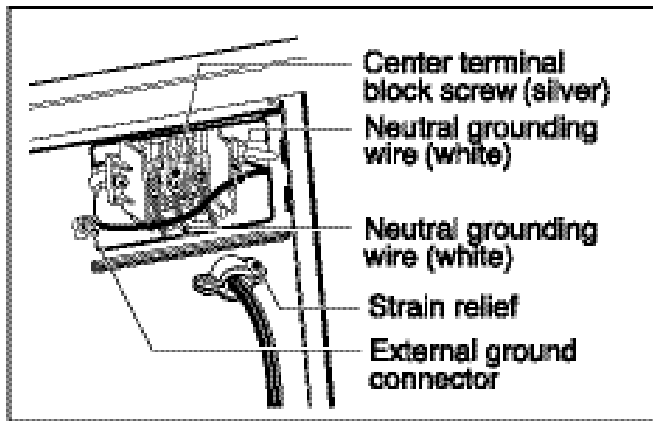

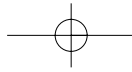

## Option 1: 4-wire connection with a power supply cord.

- If your local codes or ordinances do not allow the use of a 3-wire connection, or you are installing your dryer in a mobile home, you must use a 4-wire connection.

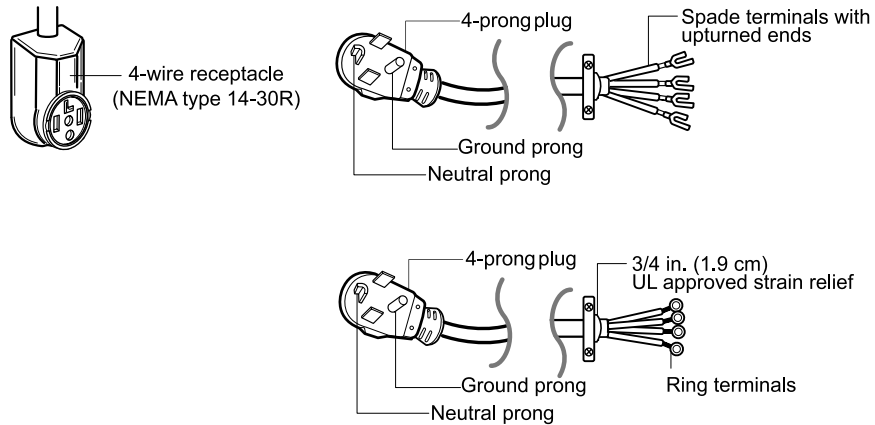

1. Connect neutral wire (white) of power cord to center terminal block screw.
2. Connect red and black wires to the left and right terminal block screws.
3. Connect ground wire (green) of power cord to external ground screw and move neutral ground wire of appliance and connect it to center screw.
4. Make sure that the strain relief is tightened.  
Be sure that all terminal block nuts are on tight and power cord is in right position.

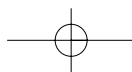
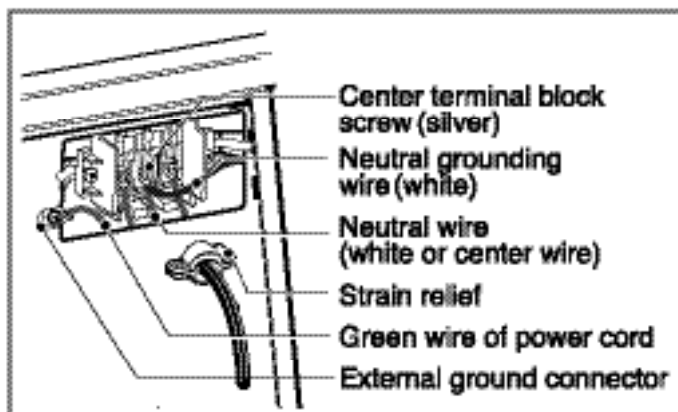

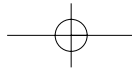

## Option 2: 3-Wire connection with a power supply cord.

If your local codes or ordinances permit the connection of a frame-grounding conductor to the neutral wire, use these instructions.

If your local codes or ordinances do not allow the connection of a frame-grounding conductor to the neutral wire, use the instructions under Section 1: Optional 3- wire connection.

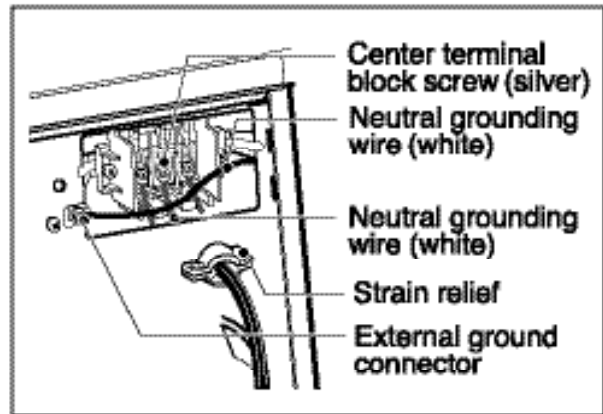
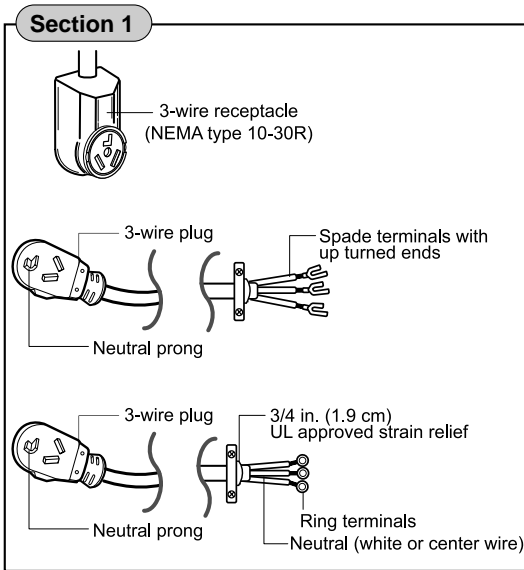

## Option 3: Optional 3-wire connection.

• If your local codes or ordinances do not allow the connection of a frame-grounding conductor to the neutral wire, use the instructions under this section.

1. Connect neutral wire (white) of power cord to center terminal block screw.
2. Connect ground wire of appliance and neutral wire of power cord to center terminal block screw.
3. Connect red and black wires to the left and right terminal block screws.
4. Make sure the strain relief screw is tightened. Be sure that all terminal block nuts are on tight and power cord is in right position.
5. Connect independent ground wire from external ground connector to proper ground.

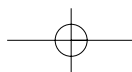
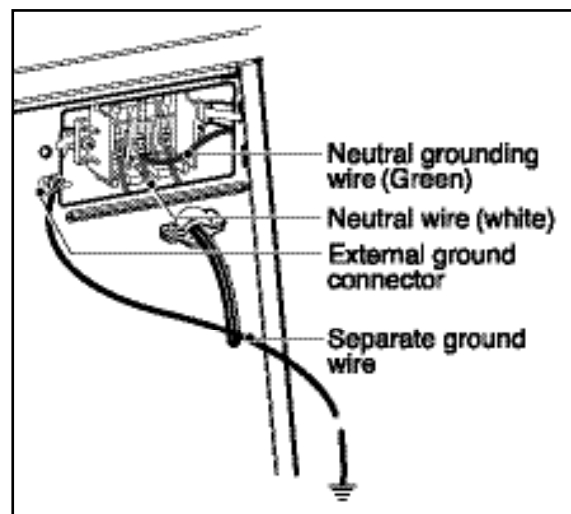
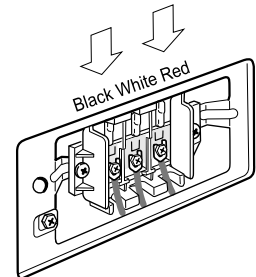

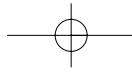

# PART 6 USER-MAINTENANCE INSTRUCTIONS

Following are important instructions and information concerning the exhaust requirements for your dryer.

**⚠ Important Warning**  
 To reduce the risk of fire, electric shock, or injury to person, read the IMPORTANT SAFETY INSTRUCTIONS before operating this appliance. To reduce the risk of fire, combustion, or accumulation of combustible gases, DO NOT exhaust dryer air into an enclosed and unventilated area, such as an attic, wall, ceiling, crawl space, chimney, gas vent, or concealed space of a building. To reduce the risk of fire, DO NOT exhaust the dryer with plastic or thin foil ducting.

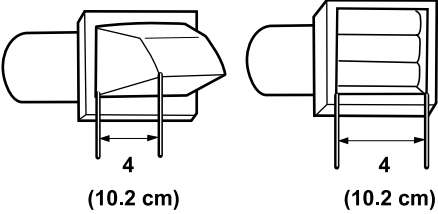
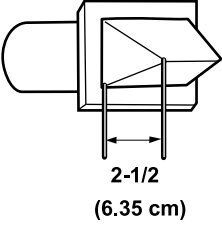
Weather Hood Type	Number of 90° Elbows	Maximum length of 4" (10.2 cm) diameter rigid metal duct	Maximum length of 4" (10.2 cm) diameter flexible metal duct
<b>Recommended</b> 	0	65 feet (19.8 m)	45 feet (13.7 m)
	1	55 feet (16.8 m)	35 feet (10.7 m)
	2	47 feet (14.3 m)	30 feet (9.1 m)
	3	36 feet (11.0 m)	25 feet (7.6 m)
	4	28 feet (8.5 m)	20 feet (6.1 m)
<b>Use Only for Short Run Installations</b> 	0	55 feet (16.8 m)	35 feet (10.7 m)
	1	47 feet (14.3 m)	27 feet (8.2 m)
	2	41 feet (12.5 m)	21 feet (6.4 m)
	3	30 feet (9.1 m)	17 feet (5.2 m)
	4	22 feet (6.7 m)	15 feet (4.5m)

**NOTE:** Deduct 6 feet (1.8 m) for each additional elbow. It is not recommended to use more than 4 90° elbows.

### Exhaust Requirements and Instructions:

- Venting materials are not provided with the dryer and you should obtain the necessary venting materials. For example, the outer end of exhaust pipe must have a weather hood with hinged dampers to prevent back-draft when the dryer is not in use.
- The exhaust duct must be four inches (10.2 cm) in diameter with no obstructions. The exhaust duct should be kept as short as possible. Make sure to clean any old ducts before installing your new dryer.
- Rigid or semi-rigid metal ducting is recommended for use as transition ducting between the dryer and the wall. In special installations when it is impossible to make a connection with the above recommendations, then a UL-listed flexible metal transition duct may be used between the dryer and wall connection only. The use of this ducting will affect dry time.
- DO NOT use sheet metal screws on exhaust pipe joints or other fastening means which extend into the duct that could catch lint and reduce the efficiency of the exhaust system. Secure all joints with duct tape.
- To maximize operating results, please observe the duct length limitations noted in the chart above.

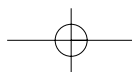

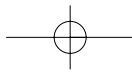

## Exhaust and Dryer Maintenance

### **WARNING!**

Disconnect the dryer's electric power prior to any cleaning or maintenance.

1. After one year of use, the interior and complete exhaust system of the dryer should be examined and cleaned if necessary.
2. Before one year of use, when drying performance has become unsatisfactory, please examine and clean the exhaust duct for better drying performance.
3. Check the weather hoods frequently to ensure the dampers are moving freely, that the dampers are not pushed in and that nothing has been set against the dampers.
4. A qualified service person or company should be used to perform this maintenance.
5. A Flexible Metal Vent Kit, sold separately, can be used to exhaust the dryer when it is placed in hard to reach location. This Kit comes in two pieces, one to attach on the dryer and the other to attach on the wall exhaust outlet. After attaching two separate pieces to the dryer and the wall, the dryer may be returned to its final position, after which the two pieces themselves can be connected.
6. Ordinarily, the dryer drum will need no care. Wipe the exterior of the dryer as required, and always wipe the exterior of the dryer in the event any detergent, bleach, or other washing products is spilled on the dryer.
7. Clean the control panel with a damp cloth as necessary. Warning: spray pre-wash products may damage the finish of the control panel.
8. Please clean the lint filter either before drying each load or after drying each load.
9. Always make sure the lint filter is clean before starting a new load, because a clogged lint filter may increase drying times.
10. Annually remove the lint filter and attach it to the vacuum duct. See item #2 above.
11. Please note that the wiring diagram is provided inside the dryer control hood. Label all wires prior to disconnection when servicing the dryer, because wiring errors can cause serious injury to you and your dryer.

## Cleaning the Lint Screen

1. Clean the lint filter once either before or after drying each load. Always make sure the lint filter is clean before starting a new load, because a clogged lint filter may increase drying times.
2. To clean, pull the lint screen straight up and roll any lint off the screen with your fingers. Do not rinse or wash screen to remove lint. Push the lint screen firmly back into place.
3. Always ensure the lint screen is firmly secured before running the dryer. Running the dryer with a loose lint screen may cause overheating and damage to the dryer and articles being dried.
4. Some articles may shed more lint than others, causing the lint screen to fill rapidly. Remove lint from the lint screen before and after drying these articles, such as new towels.
5. In the event lint falls off of the lint screen and into the dryer during removal, inspect the exhaust hood and remove any lint.
6. Laundry detergent and fabric softener residue can build up on the lint screen, causing longer drying times. The screen is likely blocked if lint falls off the screen. In order to prevent this type of build up, and help ensure proper operation of your dryer, clean the lint screen with a nylon brush every six months or more frequently, if necessary. The lint filter can also be washed as follows:
  - a) After rolling the lint off of the screen with your fingers, wet both sides of the screen with hot or warm water.
  - b) Wet a nylon brush with hot water and liquid detergent and scrub the lint screen with the brush to remove the buildup of detergent and fabric softener.
  - c) After the residue has been removed, rinse screen with hot water.
  - d) After drying the lint screen with a clean towel, firmly replace the lint screen in your dryer.

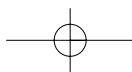

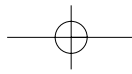

# PART 7 OPERATING YOUR DRYER

Following are instructions for starting and using your new dryer. Please refer to specific sections of this manual for more detailed information.

**Important Warning:** To reduce the risk of fire, electric shock, or injury to person, read this entire manual, including the **Important Safety Instructions**, before operating this dryer.

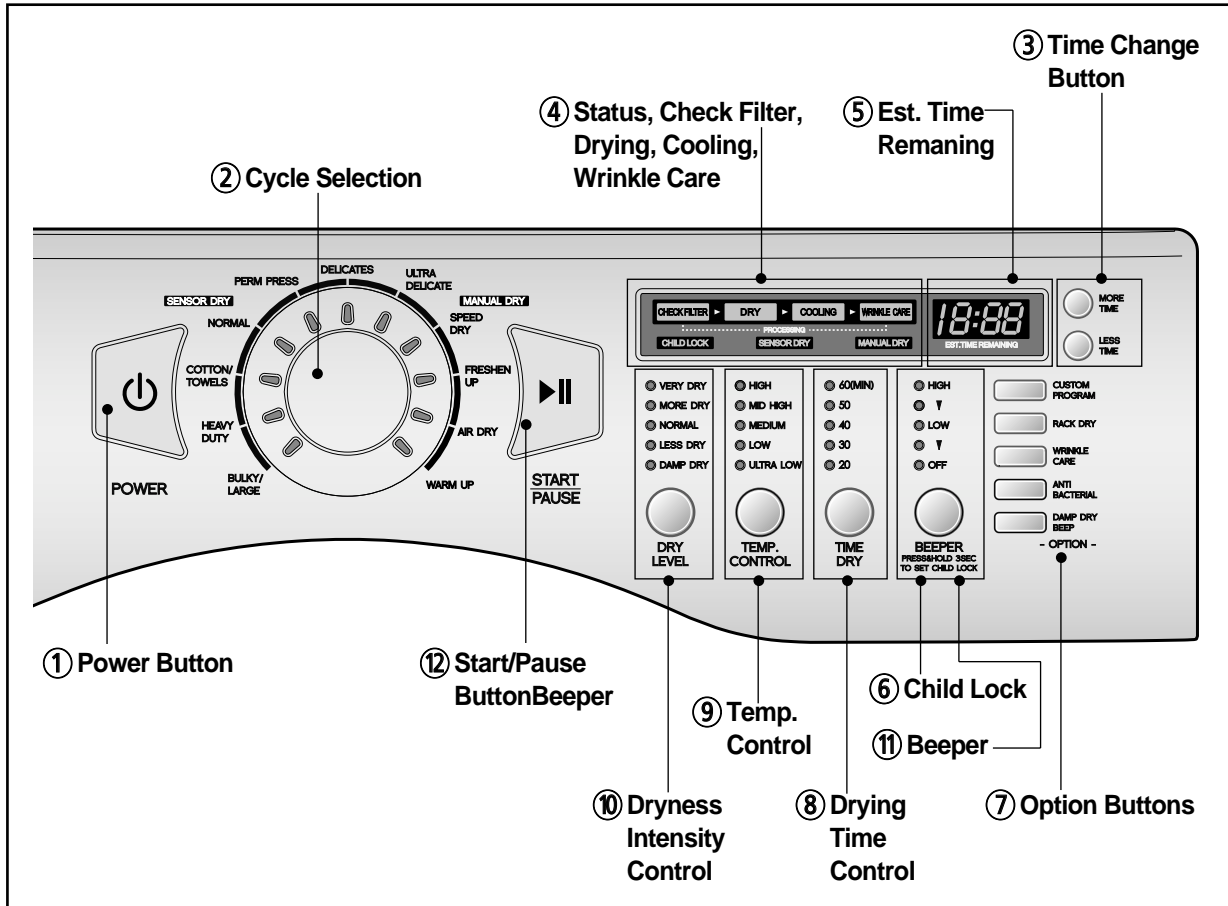

**⚠ WARNING!**

**Fire Hazard**

No washer can completely remove oil. Do not dry anything that has ever had any type of oil on it (including cooking oils). Items containing foam, rubber, or plastic must be air dried. Failure to follow these instructions can result in death or fire.

**⚠ WARNING!**

**Explosion Hazard**

Keep flammable materials and vapors, such as gasoline, away from dryer. Do not dry anything that has ever had anything flammable on it (even after washing). Failure to follow these instructions can result in death, explosion, or fire.

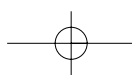

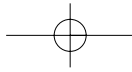

### ■ Select cycles designed for option

Level	More Time	Less Time	Custom Program	Rack Dry	Wrinkle Care	Anti Bacterial	Damp Dry Beep
Bulky/Large			<input type="radio"/>	<input type="radio"/>	<input type="radio"/>	<input type="radio"/>	<input type="radio"/>
Heavy Duty			<input type="radio"/>	<input type="radio"/>	<input type="radio"/>	<input type="radio"/>	<input type="radio"/>
Cotton/Towls			<input type="radio"/>	<input type="radio"/>	<input type="radio"/>	<input type="radio"/>	<input type="radio"/>
Normal			<input type="radio"/>	<input type="radio"/>	<input type="radio"/>	<input type="radio"/>	<input type="radio"/>
Perm Press			<input type="radio"/>	<input type="radio"/>	<input type="radio"/>		<input type="radio"/>
Delicates			<input type="radio"/>	<input type="radio"/>	<input type="radio"/>		<input type="radio"/>
Ultra Delicates			<input type="radio"/>	<input type="radio"/>	<input type="radio"/>		<input type="radio"/>
Speed Dry	<input type="radio"/>	<input type="radio"/>	<input type="radio"/>	<input type="radio"/>	<input type="radio"/>		
Freshen Up	<input type="radio"/>	<input type="radio"/>	<input type="radio"/>	<input type="radio"/>	<input type="radio"/>		
Air Dry	<input type="radio"/>	<input type="radio"/>	<input type="radio"/>	<input type="radio"/>	<input type="radio"/>		
Dry	<input type="radio"/>	<input type="radio"/>	<input type="radio"/>	<input type="radio"/>	<input type="radio"/>		

A. If you select Rack Dry, the previous course and operation goes off.

B. If you select Rack Dry, Wrinkle Care, Anti-Bacterial, or Damp-Dry-Beep is not available.

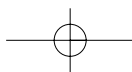

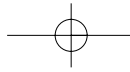

## 1 Power Button

- Use this button for power on or off.

## 2 Cycle Selection

- Turn the knob to select the desired cycle based on laundry types and conditions.

### (1) Sensor Dry Cycles

Sensor Dry Cycles allow you to match the cycle to the load you are drying. Each cycle dries certain fabrics at the recommended temperature.

A sensor detects the moisture in the load and automatically adjusts the drying time for optimal drying

#### **Bulky/Large**

Use for drying heavy fabrics such as quilts and blankets.

#### **Heavy Duty**

Use for drying heavy fabrics such as jeans, corduroys or work clothes.

#### **Cotton/Towels**

Use for drying denims, towels, heavy cottons.

#### **Normal**

Use for drying sturdy fabrics such as casual clothes.

#### **Perm. Press**

Use for permanent pressed and synthetic items.

#### **Delicates**

Use for drying synthetic fabrics, washable knit fabrics and no-iron finishes.

#### **Ultra Delicate**

Use for drying gentle items such as workout wear, shear and lace items.

Sensor Dry Preset Cycle Settings		
Sensor Dry Cycles Load Type	Temp.	Time* (Minutes)
<b>BULKY/LARGE</b> Bulky, heavy weight	High	55
<b>HEAVY DUTY</b> Jeans, heavy weight	High	50
<b>COTTON/TOWELS</b> Towel, denim pants	Mid High	59
<b>NORMAL</b> Work clothes, corduroys	Medium	47
<b>PERM. PRESS</b> Synthetics , permanent press	Low	40
<b>DELICATES</b> Lingerie, sheets, blouses	Low	35
<b>ULTRA DELICATE</b> Shear, workout wear and lace items	Ultra Low	35

### (2) Manual Dry Cycles

Use Manual Cycles to select a specific amount of drying time and a drying temperature.

When a Manual Cycle is selected, the ESTIMATED TIME REMAINING display shows the actual time remaining in your cycle. You can change the actual time in the cycle by pressing MORE TIME or LESS TIME.

#### **Speed Dry**

Use for small loads or loads that need less drying time.

#### **Freshen Up**

Use this cycle to remove wrinkles from items, such as clothes packed in a suitcase or items wrinkled from being left in the dryer too long.

#### **Air Dry**

Use the Air Dry Modifier for items that require drying without heat such as rubber, plastic and heatsensitive fabrics.

#### **Warm Up**

Use this cycle to remove wrinkles or smell from items, such as clothes packed in a suitcase or items wrinkled from being left in the dryer too long.

Preheating use of cold clothing.

Manual Preset Cycle Settings		
Manual Dry Cycles Load Type	Temp.	Default Time* (Minutes)
<b>SPEED DRY</b> SMALL LOADS	High	30
<b>FRESHEN UP</b> Remove Wrinkles	Mid High	30
<b>AIR DRY</b>	Air Dry	35
<b>WARM UP</b>	Medium	20

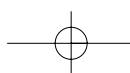



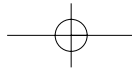

### 3 Time Change Button

- Press MORE TIME or LESS TIME until the desired drying time is set.

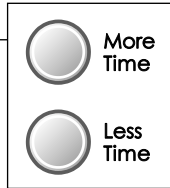

**NOTE:** Time change button is available only with Manual Dry, Time Dry and Rack Dry programs.

### 4 Status/Clean Filter/Wrinkle Care Indicator

- When Wrinkle Care is selected, the light for "Wrinkle Care" will glow in the display. When power is on, CHECK FILTER is displayed until start/pause is selected.

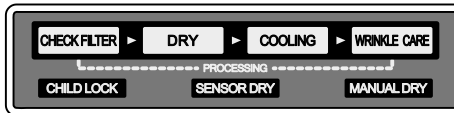

**⚠ WARNING!**  
For better drying performance and safety, clean lint filter every single use.

### 5 Estimated Time Remaining

- The display shows the estimated time remaining. In addition to this, if the dryer has some problem, it displays error messages. Refer to troubleshooting guide



### 6 Child Lock



#### (1) Child Lock

Child Lock can be used to prevent children from changing options on control panel while the dryer is running. When Child Lock is enabled, all the buttons will be locked and Child Lock will glow. To enable Child Lock, Press and hold Beeper Dry for 3 seconds, until there is a single beep tone and Child Lock is displayed on the status window. To disable Child Lock, press and hold Beeper Dry for 3 seconds again.

### 7 Option Buttons

#### (1) CUSTOM PROGRAM

Set up your favorite combination of settings and save them here for one touch recall.



1. Select a cycle.
2. Change DRY LEVEL and TEMP. CONTROL.
3. Select OPTIONS you want.
4. Press and hold the CUSTOM PROGRAM.

To recall your stored CUSTOM PROGRAM Press CUSTOM PROGRAM button, then press START/PAUSE.

#### (2) Rack Dry

Rack Dry is designed to use for items which are not suitable for tumble drying such as sweaters, silk or lingerie.



This option may be used for drying Sneakers.

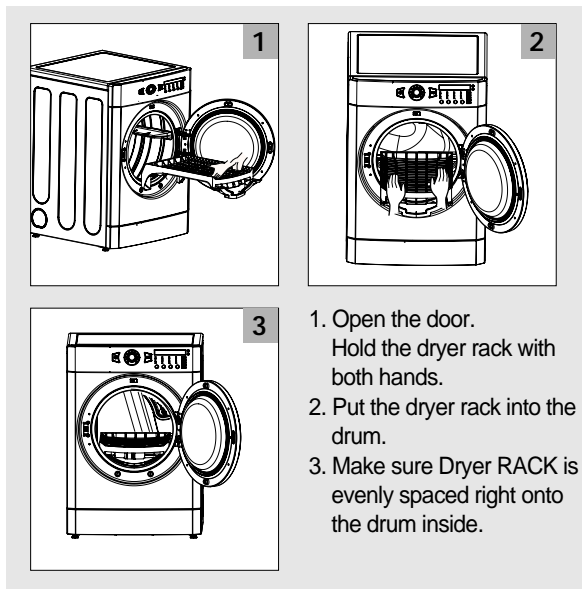

**NOTE:** Don't use the rack for normal tumble drying. The rack is shipped in place in your dryer. Please remove the rack before using this dryer for the first time.

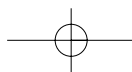

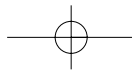

Suggested Items for Rack Drying	Temperature Setting	Suggested Time* (Minutes)
Washable wool items	Low	20
Stuffed toys with cotton or polyester fiber filling	Low/Ultra Low	20/30
Stuffed toys, foam rubber filled.	Air Dry/ Ultra Low	50/30
Foam rubber pillows	Air Dry	50
Athletic shoes	Air Dry	20

\* Reset time as needed to complete drying.

### (3) Wrinkle Care

This option helps to prevent wrinkles on your laundry.



When you select the wrinkle care option, the dryer will periodically tumble for up to three hours after the cycle has completed.

You can use this option in case you can not remove laundry immediately after drying is done.

### (4) Anti Bacterial

This option reduces bacteria by using high temperature during the cycle.



This option can only be used with the Heavy Duty, Cotton/Towels and Normal cycles.

**NOTE:** Do not use this cycle with delicate fabrics.

### (5) Damp Dry Beep

When you select the damp dry beep option, a beep will alert you when your load is just damp enough for ironing or pressing.



This notice will allow you to remove lightweight items that are dried or other items that you may wish to iron.

### 8 Time Dry

- Use Time Dry Option to change Drying Time on your own. You can select the desired operation time manually by pressing Time Dry button between 20 to 60 minutes.

- 60 (MIN)
- 50
- 40
- 30
- 20



### 9 Temp. Control

- Use Temp. Control Option to select temperatures for the Manual Cycles. Press TEMP. CONTROL until the desired temperature setting glows. Temperature modifiers cannot be used with the Sensor Dry Cycles.

- HIGH
- MID HIGH
- MEDIUM
- LOW
- ULTRA LOW



### When Using Air Dry

This chart shows examples of items that can be dried using AIR DRY.

Type of Load	Default Time* (Minutes)
Foam rubber-pillows, padded bras, stuffed toys	20 - 30
Plastic shower curtains, tablecloths	20 - 30
Rubber-backed rugs	40 - 50
Olefin, polypropylene, shear nylon	10 - 20

\* Reset cycle to complete drying, if needed.

- Check to see that coverings are securely stitched.
- Shake and fluff pillows by hand periodically during the cycle.
- Dry item completely. Foam rubber pillows are slow to dry.

**NOTE:** DRY LEVEL selections can only be made while using Sensor Dry Cycles. Selecting MORE Dry or LESS Dry automatically adjusts the needed time which is already sensed.

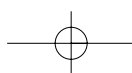

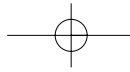

### 10 Dry Level

- Use these buttons to set dry level
- First, select sensor dry cycle.
- Select dry level to adjust how much you want to dry the load.  
As the cycle runs, the control senses the dryness of the load and adjusts the time automatically based on the selected dryness level.

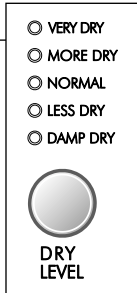

**NOTE:** DRY LEVEL selections can only be made while using Sensor Dry Cycles. Selecting MORE Dry or LESS Dry automatically adjusts the needed time which is already sensed.

### 11 Beeper

- The BEEPER controls the volume of the beep that is made when you press any of the buttons on the control panel. Press BEEPER to adjust the sound level or turn off the signal.



### 12 Start / Pause Button

- Use this button for start or pause.



## Starting your dryer

### ① Before use

- Clean lint screen before or after each cycle.
- Place laundry into dryer and shut door. See Loading.
- Turn the knob to select the drying cycle you want. The preset setting for Sensor Dry Cycles or Manual Cycles will glow. The estimated or actual cycle time (in minutes) will show in the display.

Following are sample loads for Super Capacity Dryers:	
<b>Heavy Work Clothes</b> 4 jeans 4 work pants 4 work shirts	2 sweatpants 2 sweatshirts
<b>Cotton/Towels</b> 10 bath towels 10 hand towels	14 wash cloths
<b>Mixed Load</b> 3 sheets 4 pillow cases 3 shirts 3 blouses	9 T-shirts 9 Shorts 10 handkerchiefs

### ② Loading

- Determine load size by the amount of space the load requires rather than the weight of the load.
- Avoid overloading the dryer.  
Following these instructions can help reduce your utility bill, prolong the life of your clothes, and decrease the likelihood of uneven drying and wrinkle.

### ③ To use a sensor dry cycle

- Select DRY LEVEL to adjust how dry you want the load. As the cycle runs, the control senses the dryness of the load and adjusts the time automatically for the selected dryness level.
- Select the desired options.
- Press START/PAUSE

**NOTE:** DRY LEVEL selections can only be made while using Sensor Dry Cycles. Selecting MORE Dry or LESS Dry automatically adjusts the sensed time needed.

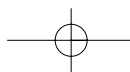

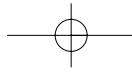

#### ④ To use a manual dry cycle

- Select a Manual Dry Cycle.
- Press MORE TIME or LESS TIME until the desired drying time is displayed.  
Tap MORE TIME or LESS TIME and the time will change by 1 minute interval.

**NOTE:** The MORE TIME or LESS TIME feature can be used with Manual Dry, Time Dry and Rack Dry Cycles.

- Press TEMP. CONTROL until the desired temperature indicator glows.
- (OPTIONAL STEP) If desired, select OPTIONS. For more details, see Options.
- Press START/PAUSE. Be sure the door is closed.
- If you do not press START/PAUSE within 10 minutes of selecting the cycle, the dryer will automatically shut off.
- If you wish to end your drying cycle after pressing START/PAUSE, press START/PAUSE again.  
To stop your dryer at any time Press START/PAUSE or open the door.

#### ⑤ Pausing or restarting

- To pause the dryer at any time: Open the door or press START/PAUSE.
- To restart the dryer Close the door. Press START/PAUSE.

**NOTE:**

Drying will continue from where the cycle was interrupted if you close the door and press START within 10 minutes.  
If the cycle is interrupted for more than 10 minutes, the dryer will shut off.  
Select new cycle settings before restarting the dryer.

## Maintenance

### Clean lint filter

Clean the lint filter after each use and check it before use. Not cleaning or emptying the filter will increase drying time and energy consumption, therefore dryer life expectancy could be shortened after all.

### Clean the door and its opening

1. Wipe the door opening. Otherwise, build-ups of dirty and foreign objects will damage sealing of door.

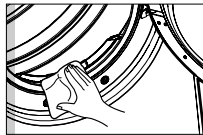

2. Clean the transparent glass door to keep inside view clear through the glass.

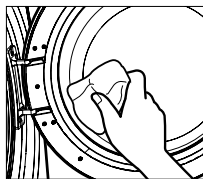

1. Open the door and pull the filter straight up.

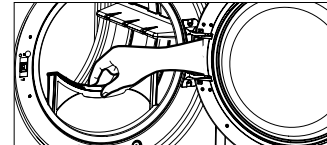

2. Clean the filter using one of the following methods.

- ① Run the fingers across the filter.

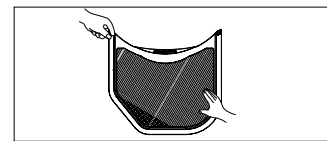

- ② Vacuum the lint filter.

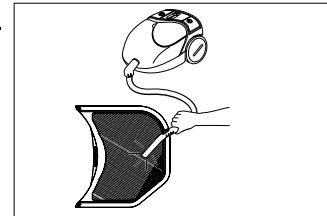

- ③ Wash the lint screen in warm, soapy water. Dry thoroughly and replace.

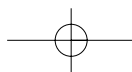
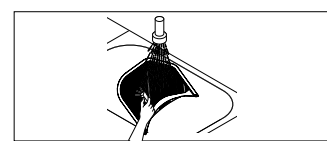

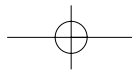

## PART 8 TROUBLESHOOTING GUIDE

### Troubleshooting Tips

Save time and money! Review the charts on the following pages first and you may not need to call for service.

#### 1. Problem: My Dryer Won't Start

Question	What to Do
• Is the dryer plugged in?	Confirm that the dryer's plug is securely and completely pushed into the laundry room's power outlet.
• Is the fuse blown, or is the circuit breaker tripped?	Check your home's or laundry room's fuse box/circuit breaker box and replace the fuse or reset the circuit breaker. (IMPORTANT: electric dryers generally use two fuses or breakers.)

#### 2. Problem: My Dryer Doesn't Heat

Question	What to Do
• Is the fuse blown, or is the circuit breaker tripped?	If the fuse is blown or the circuit breaker tripped, the dryer might tumble but not heat. Check your home's or laundry room's fuse box/circuit breaker box and replace the fuse or reset the circuit breaker. (IMPORTANT: electric dryers generally use two fuses or breakers.)
• Is the gas supply or service blocked or off?	Confirm that the house gas shutoff and the dryer gas shutoff are both fully open.

#### 3. Problem: There Are Greasy Spots On My Clothes.

Question	What to Do
• Did you follow the instructions on your fabric softener product?	Confirm and follow the instructions provided with your fabric softener product.
• Are you drying clean and dirty clothes together?	Make sure to use your dryer to dry only clean items, because dirty items can soil clean clothes placed in the same load or later placed in the dryer drum.
• Were your clothes entirely clean?	Stains on dried clothes are actually stains that weren't cleansed during the washing process. Please review and confirm that you are following your washing instructions and that the clothes are being completely cleaned.

#### 4. Problem: My Dryer Displayed An Error Code.

Question	What to Do
<b>H1</b>	Is displayed when humidity sensor is error. In this case, power off and restart.
<b>H2</b>	Is displayed when temperature sensor is error. In this case, power off and restart.
<b>H5</b>	Heater temperature control problem. In this case, call servic center.

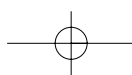

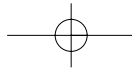

### 5. Problem: There Is Lint On My Clothes

Question	What to Do
• Is your lint filter full?	Please refer to the manual section on cleaning the lint filter, and please confirm that the lint filter is clean. It is important that the lint filter is clean before each new load of laundry.
• Did you properly sort your load of laundry?	In order to reduce the amount of lint in a load of laundry, sort lint producers (like a fuzzy white cotton towel) separately from clothes that might catch lint (such as a pair of black linen pants).
• Do your clothes have excess static electricity?	See comments below under. There Is Static In My Clothes After Drying.
• Did you overload your dryer?	Divide your larger load into smaller loads.
• Did you place any paper, tissue, or other similar material in the load?	Sometimes a person might forget to take a piece of paper or a tissue out of a pocket, and this paper, tissue, or similar material can cause excess lint in a load of laundry. Confirm that the pockets of pants, shirts, and other articles of clothing are empty before washing and drying.

### 6. Problem: There Is Static In My Clothes After Drying

Question	What to Do
• Did you use fabric softener?	Try using a fabric softener to reduce static electricity.
• Did you over dry the load of laundry?	Over-drying a load of laundry can cause a build up of static electricity. Try using a fabric softener or adjust your settings and use a shorter drying time.
• Are you drying synthetic, permanent press and blends?	These materials can cause static to build up in a load of dried clothes. Try using a fabric softener.

### 7. Problem: The Drying Time Is Not Consistent

Question	What to Do
• Are you using consistent heat settings and consistent load sizes?	The drying time for a load will vary depending on the heat setting, the type of heat used (electric, natural or LP gas), the size of the load, the type of fabrics, the wetness of the clothes and the condition of the exhaust ducts and lint filter.

### 8. Problem: Water Is Found Around The Cabinet Cover When Opening The Door.

Question	What to Do
• Is water found around cabinet cover when opening the door?	This is normal because this is condensed moisture by drying.

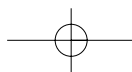

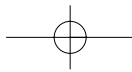

### 9. Problem: It Takes Too Long For My Clothes To Dry

Question	What to Do
• Did you properly sort your loads of laundry?	Separate heavy weight items from light weight items when creating loads.
• Are you drying large loads of heavy fabrics?	Heavy fabrics take longer to dry because they tend to retain more moisture. To help reduce and maintain more consistent drying times for large and heavy fabrics, separate these items into smaller loads of a consistent size.
• Are the dryer controls properly set?	Use the appropriate control settings for the type of load you are drying.
• Is the lint filter clean before each new load of laundry?	Please confirm that the lint filter is clean prior to each new load of laundry.
• Are the exhaust ducts clear and properly configured?	Confirm through review of the appropriate sections of this manual that the exhaust venting ductwork is properly configured. Confirm that the venting is free of obstructions. Confirm that the outside wall dampers are moving freely, that the dampers are not pushed in, and that nothing has been set against the dampers.
• Is the fuse blown, or is the circuit breaker tripped?	Check your home's or laundry room's fuse box/circuit breaker box and replace the fuse or reset the circuit breaker. (IMPORTANT: electric dryers generally use two fuses or breakers.)
• Did you overload your dryer?	Divide your larger load into a number of smaller loads.
• Did you under load your dryer?	If you are only drying a handful of items, add a few extra pieces to help ensure proper tumbling action.

### 10. Problem: My Clothes Are Wrinkled

Question	What to Do
• Are you over drying your laundry?	Over drying a load of laundry can lead to wrinkled clothes. Try a shorter drying time, and remove items while they still retain a slight amount of moisture.
• Are you removing your laundry from the dryer soon after the drying cycle is complete?	Remove your laundry from the dryer after the drying cycle ends and either hang or fold the items.

### 11. Problem: My clothes are shrinking

Question	What to Do
• Are you following the care instructions for your garment?	To avoid shrinkage, please carefully follow the care and use instructions for your garment, because some fabrics will naturally shrink when washed. Other fabrics can be washed but will shrink when dried in a dryer.

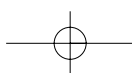

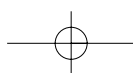
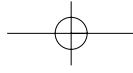



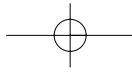

# ABOUT THIS MANUAL

VISION CREATIVE, INC.

6

4

		TEL	032 - 510 - 7235
MODEL	27	washer, dryer, combo	pedestal
BUYER	( ) CDE - 8000GW/GR/GS/GBL		
	1	08.1.07	6
	2		7
	3		8
	4		9
	5		10
<p>MEMO</p> <p>08.01.01 -</p> <p>08.01.09 - , 32</p>			

VISION

TEL: 730 - 0660 FAX: 730 - 3788

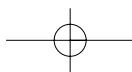

## Free Manuals Download Website

<http://myh66.com>

<http://usermanuals.us>

<http://www.somanuals.com>

<http://www.4manuals.cc>

<http://www.manual-lib.com>

<http://www.404manual.com>

<http://www.luxmanual.com>

<http://aubethermostatmanual.com>

Golf course search by state

<http://golfingnear.com>

Email search by domain

<http://emailbydomain.com>

Auto manuals search

<http://auto.somanuals.com>

TV manuals search

<http://tv.somanuals.com>