

CROSLEY

CR2413A

Memory Master

Instruction Manual

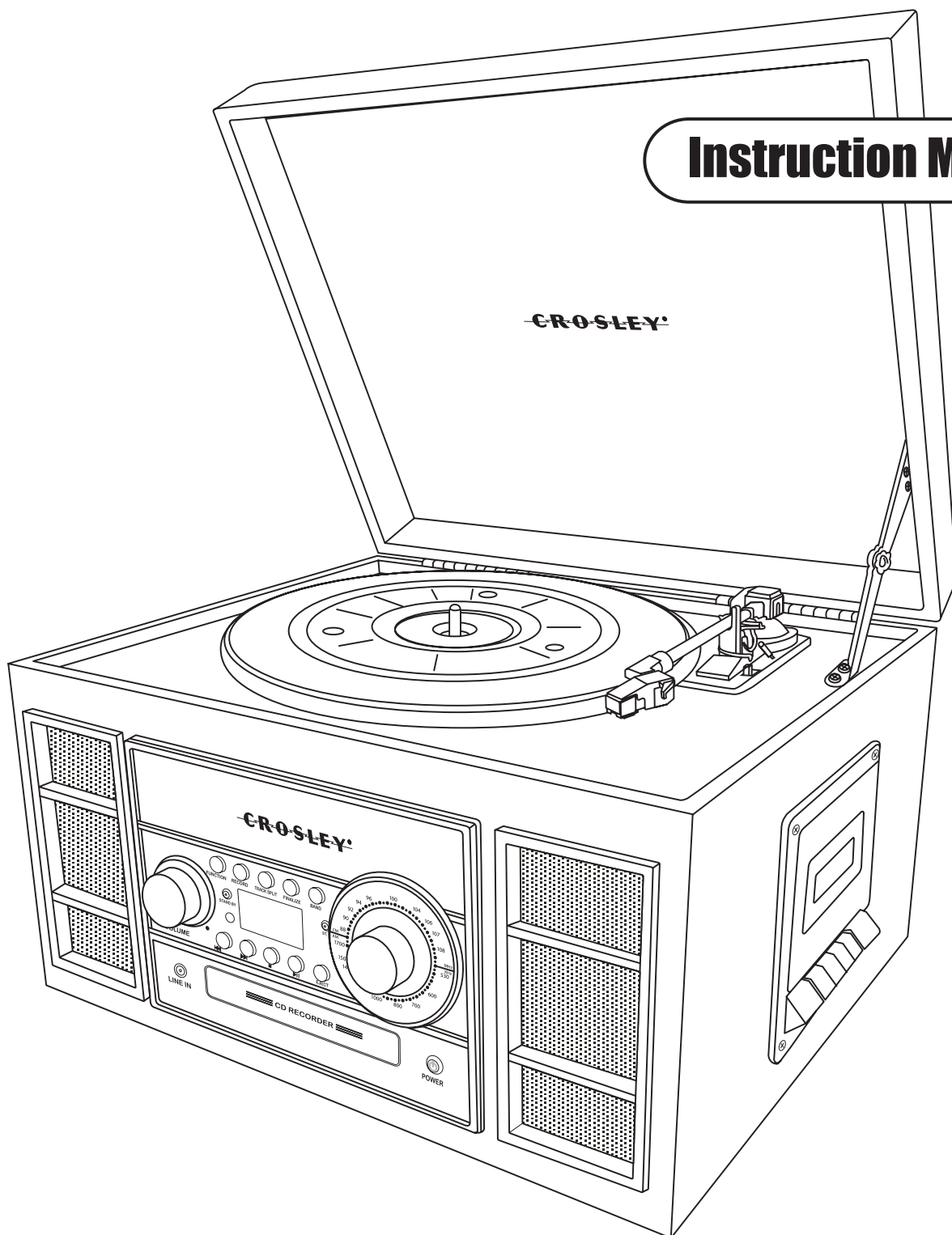

www.crosleyradio.com

IMPORTANT SAFETY INSTRUCTION

PLEASE READ CAREFULLY ALL THE FOLLOWING IMPORTANT SAFEGUARDS THAT ARE APPLICABLE TO YOUR EQUIPMENT

1. Read Instructions - All the safety and operating instructions should be read before the product is operated.
2. Retain instructions - The safety and operating instructions should be retained for future reference.
3. Heed Warnings - All warnings on the product and in the operating Instructions should be adhered to.
4. Follow Instructions - All operating and use instructions should be followed.
5. Cleaning - Unplug this product from the wall outlet before cleaning. Do not use liquid cleaners or aerosol cleaners. Use a damp cloth for cleaning.
6. Attachments - Do not use attachments not recommended by the product manufacturer as they may cause hazards.
7. Water and Moisture - Do not use this product near water - for example, near a bath tub, wash bowl, kitchen sink, or laundry tub; in a wet basement; or near a swimming pool; and the like.
8. A product and cart combination should be moved with care. Quick stops, excessive force, and uneven surfaces may cause the product and cart combination to overturn.
9. Ventilation - Slots and openings in the cabinet are provided for ventilation and to ensure reliable operation of the product and to protect it from overheating, and these openings must not be blocked or covered, The openings should never be blocked by placing the product on a bed, sofa, rug, or other similar surface. This product should not be placed in a built - in installation such as a bookcase or rack unless proper ventilation is provided or the manufacturer's instructions have been adhered to.
10. Power Sources - This product should be operated only from the type of power source indicated on the marking label, if you are not sure of the type of power supply to your home. Consult your product dealer or local power company. For products intended to operate from battery power, or other sources, refer to the operating instructions.
11. Grounding or Polarization - This product may be equipped with a polarized alternating-current line plug (a plug having one blade wider than the other). This plug will fit into the power outlet only one way. This is a safety feature. If you are unable to insert the plug fully into the outlet try reversing the plug, If the plug should still fail to fit, contact your electrician to replace your obsolete outlet. Do not defeat the safety purpose of the polarized plug.
12. Power - Cord Protection - Power - supply cords should be routed so that they are not likely to be walked on or pinched by items placed upon or against them, paying particular attention to cords at plugs, convenience receptacles, and the point where they exit from the product.
13. Lightning - For added protection for this product during a lightning storm, or when it is left unattended and unused for long periods of time, unplug it from the wall outlet and disconnect the antenna or cable system. This will prevent damage to the product due to lightning and power - line surges.
14. Power Lines - An outside antenna system should not be located in the vicinity of overhead power lines or other electric light or power circuits, or where it can fall into such power lines or circuits. When installing an outside antenna system, extreme care should be taken to keep from touching such power lines or circuits as contact with them might be fatal.
15. Overloading - Do not overload wall outlets, extension cords, or integral convenience receptacles as this can result in a risk of fire or electric shock.
16. Object and Liquid Entry - Never push objects of any kind into this product through openings as they may touch dangerous voltage points or short - out parts that could result in a fire or electric shock. Never spill liquid of any kind on the product.
17. Servicing - Do not attempt to service this product yourself as opening or removing covers may expose you to dangerous voltage or other hazards. Refer all servicing to qualified service personnel.
18. Damage Requiring Service - Unplug this product from the wall outlet and refer servicing to qualified service personnel under the following conditions;
 - a. When the power-supply cord or plug is damaged.
 - b. If liquid has been spilled, or objects have fallen into the product.
 - c. If the product has been exposed to rain or water.
 - d. If the product does not operate normally by following the operating instructions. Adjust only those controls that are covered by the operating instructions as an improper adjustment of other controls may result in damage and will often require extensive work by a qualified technician to restore the product to its normal operation.
 - e. If the product has been dropped or damaged in any way.
 - f. When the product exhibits a distinct change in performance - this indicates a need for service.
19. Replacement Parts - When replacement parts are required, be sure the service technician has used replacement parts specified by the manufacturer or have the same characteristics as the original part. Unauthorized substitutions may result in fire, electric shock, or other hazards.
20. Safety Check - Upon completion of any service or repairs to this product, ask the service technician to perform safety checks to determine that the product is in proper operating condition.
21. Wall or ceiling Mounting - The product should be mounted to a wall or ceiling only as recommended by the manufacturer.
22. Heat - The product should be situated away from heat sources such as radiators. Heat registers, stoves, or other products (including amplifiers) that produce heat.

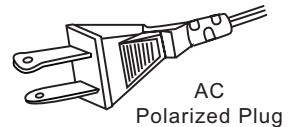

WARNING: Changes or modifications to this unit not expressly approved by the party responsible for compliance could void the user's authority to operate the equipment.

NOTE: This equipment has been tested and found to comply with the limits for a Class B digital device, pursuant to Part 15 of the FCC Rules. These limits are designed to provide reasonable protection against harmful interference in a residential installation. This equipment generates, uses, and can radiate radio frequency energy and, if not installed and used in accordance with the instructions, may cause harmful interference to radio communications. However, there is no guarantee that interference will not occur in a particular installation. If this equipment does cause harmful interference to radio or television reception, which can be determined by turning the equipment off and on, the user is encouraged to try to correct the interference by one or more of the following measures:

- Reorient or relocate the receiving antenna.
- Increase the separation between the equipment and receiver.
- Connect the equipment into a circuit different from that to which the receiver is connected.
- Consult the dealer or an experienced radio TV technician for help.

WARNING:

TO PREVENT FIRE OR SHOCK HAZARD, DO NOT EXPOSE THIS APPLIANCE TO RAIN OR MOISTURE. DO NOT REMOVE COVER. PILOT LAMPS SOLDERED IN PLACE. NO USER SERVICEABLE PARTS INSIDE. REFER SERVICING TO QUALIFIED SERVICE PERSONNEL.



The lightning flash with arrowhead symbol, within an equilateral triangle, is intended to alert user to the presence of uninsulated "dangerous voltage" within the product's enclosure that may be of sufficient magnitude to constitute risk of electric shock to persons.

CAUTION

**RISK OF ELECTRIC SHOCK
DO NOT OPEN**

CAUTION: TO REDUCE THE RISK OF ELECTRIC SHOCK, DO NOT REMOVE COVER (OR BACK). NO USER - SERVICEABLE PARTS INSIDE. REFER SERVICING TO QUALIFIED SERVICE PERSONNEL.



The exclamation point within an equilateral triangle is intended to alert user to the presence of important operating and maintenance (servicing) instruction in the literature accompanying the appliance.

Specification

Frequency Range	: AM 530 - 1700 KHz
	: FM 88 - 108 MHz
Power Supply	: AC 120V ~ 60Hz
Power Consumption	: 50W
Speed	: 33 1/3, 45, 78 RPM
Speaker	: 3"x5" 4ohm 5W x 2
Replacement Needle	: NP4

For Windows:

Windows version	Recommended RAM/processor speed	Minimum RAM/processor speed
Windows 2000, XP	512 MB/1 GHz	128 MB/300 MHz
Windows Vista Home Basic	2 GB / 1 GHz	512 MB / 1 GHz
Windows Vista Home Premium/Business/Ultimate	4 GB / 2 GHz	1 GB / 1 GHz

For Mac:

Audacity 1.2 requires MAC OS X 10.1 or later
Audacity runs best with at least 64 MB RAM and a 300 MHz processor.

* DESIGN AND SPECIFICATION SUBJECT TO CHANGE WITHOUT NOTICE.

Welcome

Thank you for purchasing the Crosley Memory Master (CR2413A). Before operating this unit, please read this manual thoroughly and retain it for future reference.

About This Manual

Instructions in this manual describe the control functions of the CR2413A.

Included in the package:

- Memory Master
- Remote Control
- 45 RPM adaptor
- RCA to 3.5mm Stereo cable
- USB cable
- Software disc
- Software Installation Guide

Table of Contents

Getting Started

Unpacking.....	4
Power Source.....	4
Control Locators.....	5-6

Basic Operation

General.....	7
Radio Operation.....	7
USB Operation.....	7
Turntable Operation.....	8
Cassette Operation.....	8

CD Operation

Playing a CD.....	9
Programmed Playback.....	9
Playing MP3 CD's.....	10
Recording records to CD.....	11
Recording cassettes to CD.....	11
Erasing CD-RW CD's.....	12

Audio / Connections

Audio.....	13
------------	----

General

Troubleshooting Guide.....	14
Warranty.....	15

Getting Started

Unpacking

- 1 Remove packing materials from unit.
NOTE: Save all packing materials.
- 2 Remove plastic bag covering radio.
- 3 Remove plastic safety cover from A/C plug.
- 4 Remove tie from A/C cord and untie antenna wire on back of radio.
- 5 Open lid and remove styrofoam shipping material from turntable.
- 6 Remove black tie-wrap from under the tone arm.
- 7 Remove tape and white protective needle cover by gently pulling them towards the front of the unit.

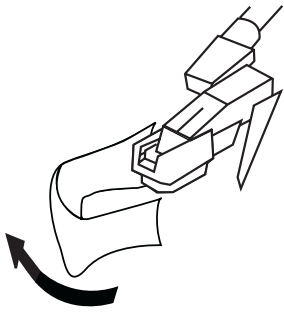

- 8 Turn the TURNTABLE SUSPENSION SCREW clockwise until it is all the way down. Do not force or over tighten it. This allows the turntable to float on its shock absorbers.

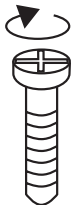

- 9 Release tone arm hold down clip by gently pushing to the right. This will unlock tone arm from its arm rest. Re-lock the hold down clip when moving the unit to another location.

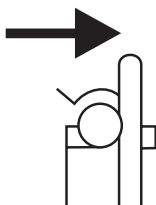

Power Source

- 1 Unwind the AC POWER CORD at the back of the unit and connect it to a power outlet.
- 2 Plug A/C cord into appropriate outlet.

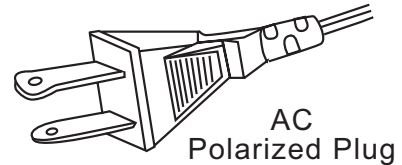

- 3 This product is equipped with a polarized alternating current line plug (a plug having one blade wider than the other). This plug will fit into the power outlet only one way. This is a safety feature. If you are unable to insert the plug fully into the outlet, try reversing the plug. If the plug should still fail to fit, contact your electrician to replace your obsolete outlet. Do not defeat the purpose of the polarized plug.

Control Locators

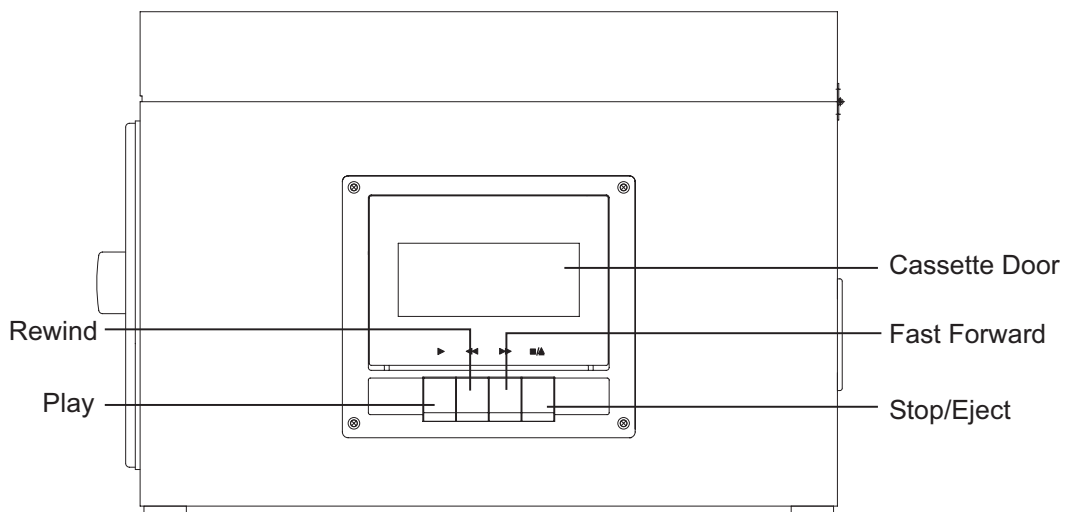
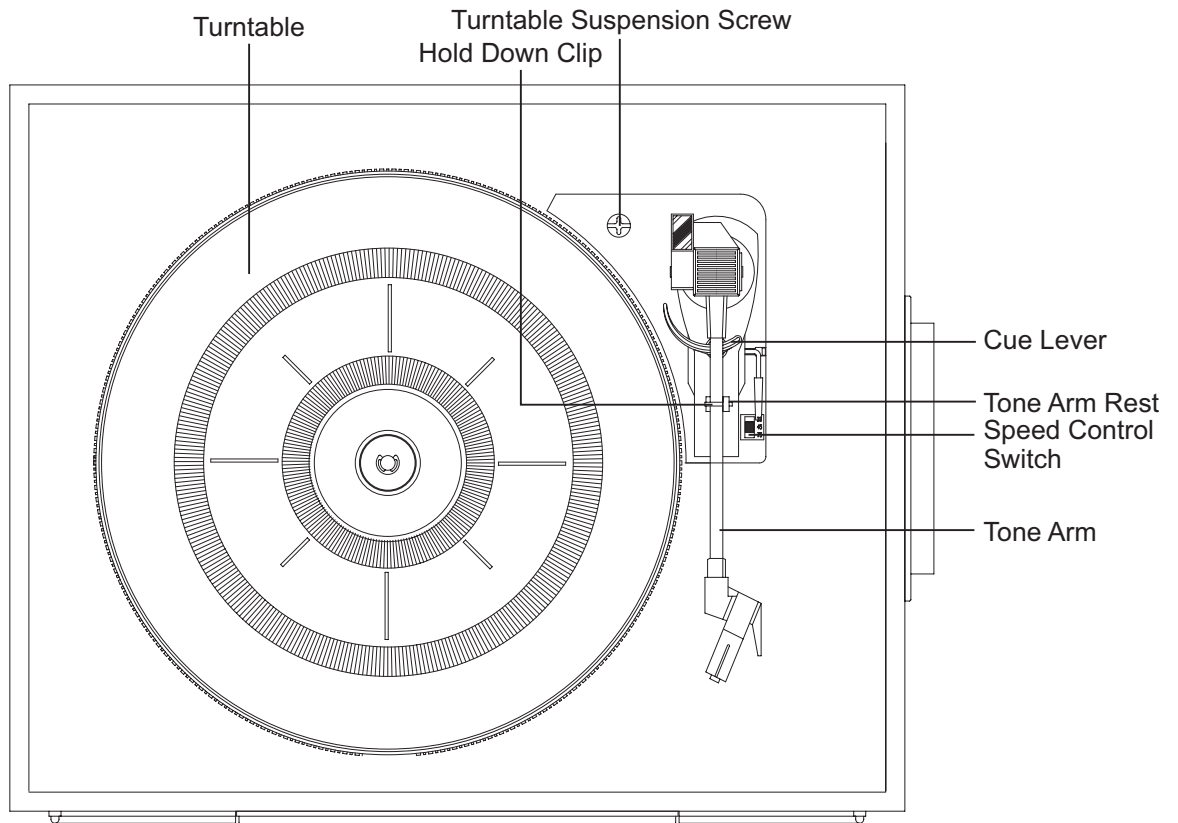
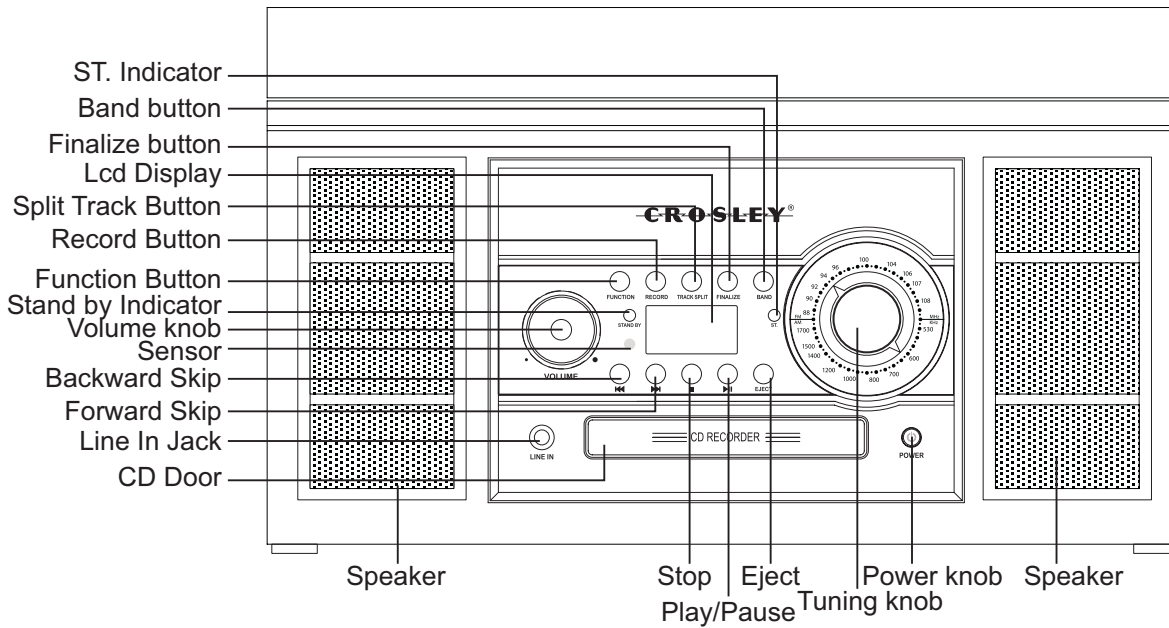

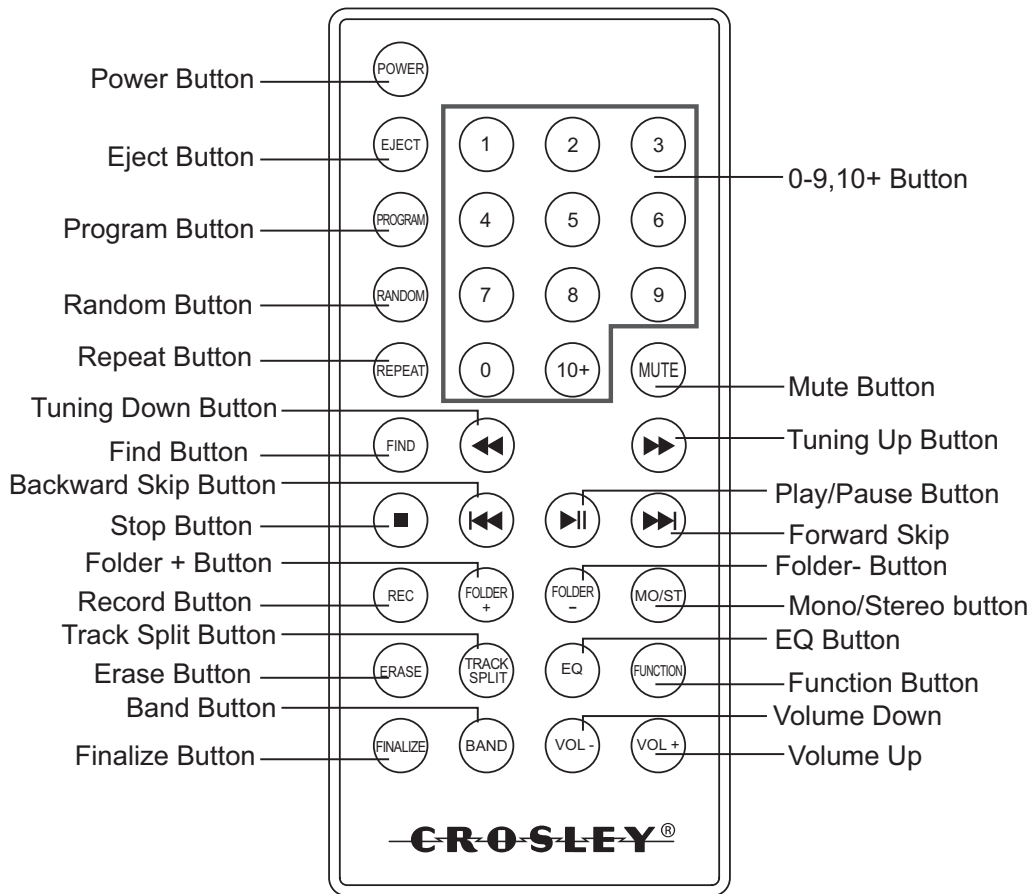
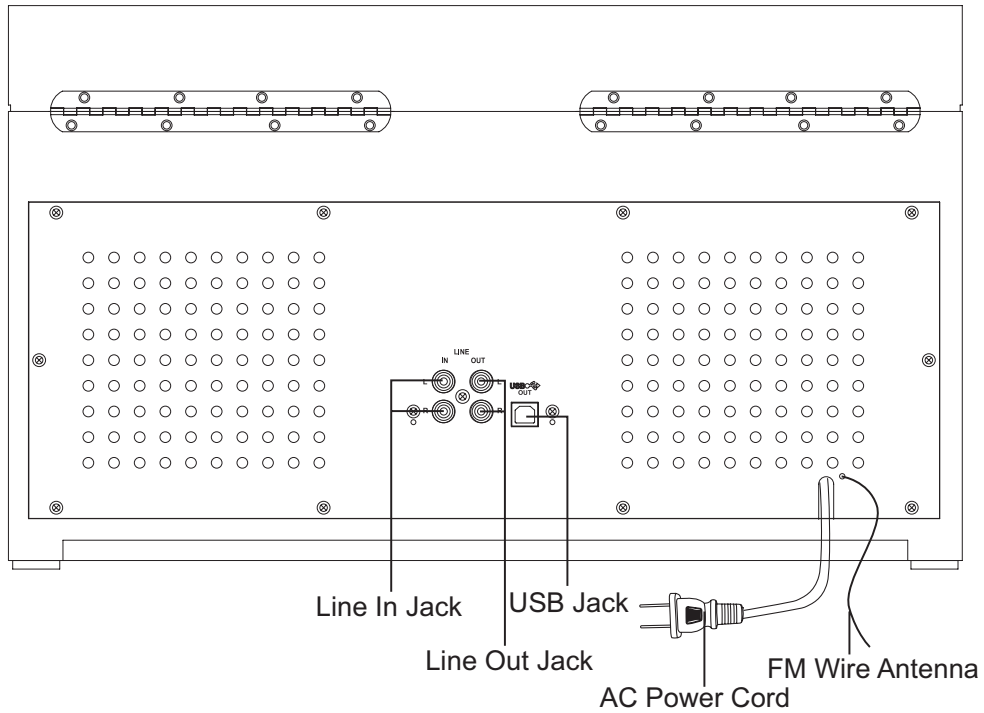

Control Locators





Basic Operation

General

- 1 Make sure the unit is plugged in correctly to an AC outlet.
- 2 Press the **POWER button** /  to turn on the unit .
- 3 Once the power is turned on, press the **FUNCTION button** /  to switch between CD/Tuner/Phono/Aux. When switching between functions, wait one second after pressing the function button before pressing it again. This gives the unit time to load the correct information for the selected function.

Radio Operation

- 1 Press the **FUNCTION button** /  to set the unit to Tuner mode
- 2 Press the **BAND button** /  to select the desired tuning band (AM/FM).
- 3 Select the desired radio station by rotating Tuning knob .
- 4 Adjust the volume to the desired listening level.

Antenna

Antenna: for FM reception, the unit is provided with a FM WIRE ANTENNA , move the wire until the reception is clear and with no interferences. For AM reception, the unit is provided with a directional build-in ferrite antenna. Rotate the set to find the position in which the best reception is obtained. Do not connect the EXTERNAL FM ANTENNA to any outside antenna.

USB Operation

Using the included software and cable, the USB connection allows you record your records onto your computer. Follow these instructions to use the USB.

- 1 Insert the enclosed software CD into your computer.
- 2 Connect the small end of the USB cable to the USB JACK on the back of the unit.
- 3 Follow the instructions on the computer screen to install the software. If the software does not load automatically, browse the CD and open the Read Me folder for further instructions.
- 4 Connect the other end to a USB port on your computer.
- 5 On your computer, open the Record Recording Software.
- 6 For instructions on operating the Record Recording Software, browse the software CD and open the Read Me folder.

Basic Operation

Turntable Operation

- 1 Press the **FUNCTION** button /  to set the unit to Phono mode.
- 2 Set the **SPEED CONTROL SWITCH** to the correct speed (33 $\frac{1}{3}$, 45 or 78 rpm) for the selected record.
- 3 Use the **CUE LEVER** to raise the tone arm off its rest. Move the tone arm over the record and use the cue lever to lower it to the point you want the record to start.
- 4 At the end of the record, the tone arm will return to its rest.

NOTE: The turntable and cassette players both operate in the same mode. Make sure the cassette player is in **STOP** mode when listening to a record.

Accessory: ADAPTER FOR 45 RPM

To play the 45rpm record, place the ADAPTER on the spindle.

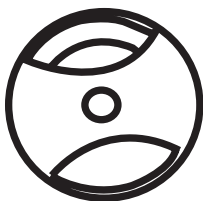

Playing a Cassette

- 1 While in Phono mode, press the **STOP/EJECT** button on the cassette player to open the cassette door.
- 2 Insert a prerecorded cassette tape into the cassette door.
- 3 Press the **PLAY** button to begin play.
- 4 To stop playback, press the **STOP/EJECT** button.
- 5 Press the **STOP/EJECT** button again to eject the cassette.









To Fast Forward or Rewind

- 1 While playback is stopped, press the **FAST FORWARD** or **REWIND** button to fast forward or rewind the cassette.
- 2 Once the desired position is reached on the cassette, press the **STOP/EJECT** button to stop the cassette.
- 3 Press the **PLAY** button to begin play.



NOTE: The cassette player plays the side of the cassette facing away from the unit. To play the other side of the cassette, you must eject the cassette and turn it over.

CD Operation



Playing a CD

- 1 Press the **FUNCTION button** /  to set the unit to CD mode.
- 2 Press the **EJECT button** /  to open the CD drawer. Insert a CD into the tray with the label side facing up.
- 3 Press the **EJECT button** /  again to close the CD drawer. The display will show "CD Load" for a few seconds and playback will automatically begin.
- 4 To skip forwards or backwards through the tracks on a CD, press the **Forward Skip** /  or **Backward Skip** /  buttons.
- 5 To fast forward or rewind through a track, press and hold the **Forward Skip** /  or **Backward Skip** /  buttons on the control panel. Release the buttons once you reach the desired position on the track. To use the remote to fast forward or rewind, press the  button or  button one time. Once the desired position is reached, press the button again to resume play.





Repeat Playback

- 1 To repeat a single track, select the desired track number and press the **REPEAT button** /  once. Press the PLAY button. "Repeat one" will show on the display and the selected track will repeat once it is finished.
- 2 To repeat a whole CD, press the **REPEAT button** /  twice. The display will show "Repeat All". Once the disc is finished, it will start over again from the beginning.
- 3 To turn off the repeat feature, press the **REPEAT button** /  again. The repeat display will disappear from the LCD.

Random Play

- 1 While playing a CD, press the **RANDOM button** /  on the remote control. "Rand" will show on the LCD display. The unit will randomly select songs from the CD.
- 2 To cancel Random playback, press the **RANDOM button** /  again.

Programmed Playback

- 1 Make sure the CD is stopped.
- 2 Press the **PROGRAM button** / . "01" will shown on the display.
- 3 Press the **Forward Skip** /  or **Backward Skip** /  buttons to select a desired track.
- 4 Press the **PROGRAM button** /  twice to store the selected track number.
- 5 Repeat above steps 3 and 4 to program additional tracks into memory.

NOTE: Maximum of 99 tracks can be programmed into memory.





CD Operation

Playing MP3 CD's

This unit will play CD's recorded in MP3 format. All the controls and functions work the same as a regular CD. Listed below are features and instructions that are unique to playing a MP3 CD.



Folder/Album Playback

If your MP3 CD is separated into folders, follow the steps below to access the folders.

- 1 While the CD is stopped, press the **FOLDER+** /  or the **FOLDER-** /  buttons to advance forward or backwards through the folders on your disc.
- 2 Once the desired folder is reached, use the **Forward Skip** /  or **Backward Skip** /  buttons to select the desired track.
- 3 Press the **PLAY** /  to begin playback of the selected track.

CD Information

If the MP3 CD has track information stored on it, such as artist and title, the LCD will display that information during playback of the CD.





- 1 While the MP3 disc is playing, press the **BAND button** / .
- 2 The CD information will start to scroll across the LCD.
- 3 Press the **BAND button** /  again to cancel the information.

NOTE: If the CD was recorded without any track information, UNKNOWN will be displayed when the BAND button is pressed.





Search Play

MP3 CD's normally contain many files. By using the search features described below, you can easily and quickly locate albums or songs. Follow the steps below to use the search feature.

Search by File Name

- 1 In stop or play mode, press the **FIND** /  to start the alphabetic and numerical search.
- 2 Press the **FOLDER+** /  or the **FOLDER-** /  buttons to select the corresponding letter or number of the track you are searching for.
- 3 When the desired track is found, press the **PLAY** /  to start playing the selected track.
- 4 To exit search mode press the FIND button until the "P" disappears from the LCD display.

Search by Folder / Album Title

- 1 While the CD is stopped, press the **FIND** /  twice to start to browse the album. The search icon, ALBUM 001 and its name will be shown on the display.
- 2 Press the **FOLDER+** /  or the **FOLDER-** /  buttons repeatedly to select the desired album.
- 3 Press the **Forward Skip** /  or **Backward Skip** /  buttons to select the desired folder/album.

NOTE: The search feature will only work if the MP3 CD has information such as Folder, Artist and Song titles already stored on the CD. This information is added at the time the CD is created and cannot be added afterwards.

NOTE: You cannot record MP3 CD's with this unit. They must be created with a computer or other device.





CD Operation

CD Recording Operation

Preparation







This unit is designed to record CD-R and CD-RW discs bearing the identification logo "Compact Disc Recordable" or "CD-Rewritable". If CD's do not conform to this standard, they may not record properly.

Recording Records to CD

- 1 Load a compatible blank CD-R or CD-RW into the unit.
- 2 Press the **FUNCTION button** /  to set the unit to Phono mode.
- 3 Set the SPEED CONTROL SWITCH to the correct speed (33 1/3, 45 or 78 rpm) for the selected record.
- 4 Use the CUE LEVER to raise the tone arm off its rest. Move the tone arm over the record and use the cue lever to lower it to the point you want the recording to start.
- 5 Press the **CD RECORD button** / . "Record" will show on the LCD. The CD will begin recording.
- 6 Once the first side of the record is finished, press the **STOP button** / . The display will read "CLOSE TK" while the content is transferred to the CD. This may take several minutes. Once finished, the display will read "PHONO".
- 7 Turn the record over and repeat steps 4-6 to record the other side.
- 8 After recording is completed, press the **STOP button** / . The display will read "CLOSE TK" while the content is transferred to the CD. This may take several minutes. Once finished, the display will read "PHONO".
- 9 Once you have finished the recording, press the **FINALIZE button** /  button. The display will read "Finalize".
- 10 Once the CD has been finalized, the unit will return to Phono mode and the display will show "PHONO". The CD is now ready for use.

NOTE: If the CD is not finalized, it will not play in any other CD player. Not all CD players are compatible with CD-R and CD-RW's. Check the owner's manual for other CD players for compatibility.

Recording Cassettes to CD



- 1 Load a compatible blank CD-R or CD-RW into the unit.
- 2 Press the **FUNCTION button** /  to set the unit to Phono mode.
- 3 Load a pre-recorded cassette tape into the cassette player. Press to **PLAY** /  to get the cassette to the point in which you want to start the recording.
- 4 Once the cassette is ready and playing, press the **CD RECORD button** /  "Record" will flash on the LCD. The CD will begin recording.
- 5 Once the first side of the cassette is finished, press the **STOP button** / . The display will read "CLOSE TK" while the content is transferred to the CD. This may take several minutes. Once finished, the display will read "PHONO".
- 6 Eject the cassette tape and flip it over to the other side.
- 7 Repeat steps 4 and 5 to record the other side of the cassette.
- 8 After recording is completed, press the **STOP button** / . The display will read "CLOSE TK" while the content is transferred to the CD. This may take several minutes. Once finished, the display will read "PHONO".
- 9 Once you have finished the recording, press the **FINALIZE button** / . The display will read "Finalize".
- 10 Once the CD has been finalized, the unit will return to Phono mode and the display will show "PHONO". The CD is now ready for use.

NOTE: If the CD is not finalized, it will not play in any other CD player. Not all CD players are compatible with CD-R and CD-RW's. Check the owner's manual for other CD players for compatibility.

CD Operation





Manual Track Division

You can divide your recording into separate tracks if you wish. By doing this, each song will have its own sequential track number. To do this, you must use the **Split Track button** / .

While Recording your record or cassette, listen for the end of each song. There will usually be a brief silence between songs. Once you are at the end of the song, press the **Split Track button** / . The recording will then go to the next track number by increments of one. Once the recording is finished, you can press the **Forward Skip** /  or **Backward Skip** /  buttons to go to the beginning of each song.

Erasing a CD-RW

If using a CD-RW, you can erase the whole CD and rerecord it. Erase procedures are only possible with CD-RW discs. It is not possible to erase or rerecord a CD-R CD. To erase a CD-RW, follow the steps below.

- 1 Press the **FUNCTION button** /  to set the unit to CD mode.
- 2 Load a recorded CD-RW into the unit.
- 3 Press the **STOP button** /  to stop playback.
- 4 Press the **ERASE button** / . ERASE will appear on the display, Press **PLAY** /  button to confirm and the erasing process will begin. When finished, the display will first read "F Done" and then "BLANK".
- 5 The CD is now ready to record.

NOTE: Once a CD is erased, the contents that were on the CD cannot be retrieved.

Audio / Connections

Audio Connections

LINE IN

Using the LINE IN front input jack or back input jack will allow you to hook up additional external audio components and listen to them through your unit. Any component with an audio output such as a Tuner, can be connected by using the correct cables. This unit uses 3.5mm mini pin cable (front), standard RCA cables (back). Simply plug the connector on 3.5mm mini pin cable (front) or standard RCA cables (back), red and white one end of the cable to the red and white Aux In jacks on the back of your unit. The other end of the cable will plug into the Audio Output jack on the external component. For more information on hooking up the external component, see the owner's manual for that component.

NOTE: If you input the signal at same time, the sound will be mix.

LINE OUT

Using the LINE OUT will allow you to run the audio from your unit into a home stereo, television or other stereo source. To make this connection, you will need standard RCA cables. Plug the red and white connectors on one end of the cable into the red and white Audio Output jacks on the back of the unit. The other end of the cable will plug into the Aux Input jacks of your selected component. For more information on hooking up to the external component, see the owner's manual for that component.

NOTE: You can still listen to your unit when using the Audio Output feature

LINE IN

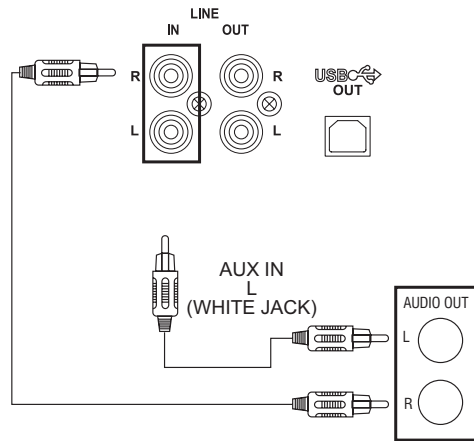

LINE OUT

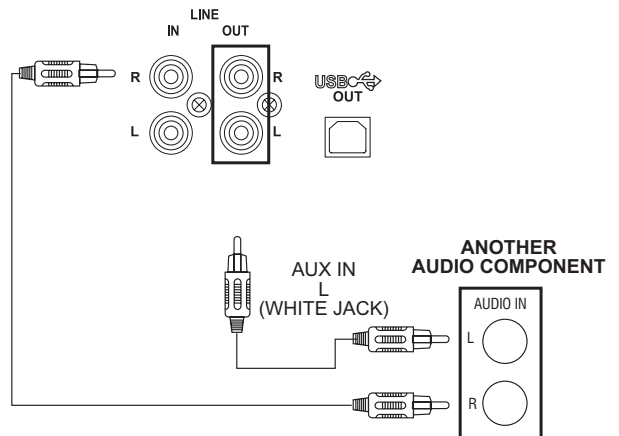

Troubleshooting

There is no Power

- 1 Make sure the power cord is plugged in correctly.
- 2 Check to see that the power button is pushed in.

There is no Sound

- 1 Check the volume level by turning the volume knob.

Turntable will not work

- 1 Make sure the unit is set to Phono mode by pressing the Function button.
- 2 Make sure the protective needle cover is removed.
- 3 Make sure the chrome Turntable Suspension Screw is screwed all the way down.
- 4 Check the cassette player to make sure a cassette is not playing.

CD does not play

- 1 Check to make sure CD is inserted correctly (label side facing up).
- 2 Check that the surface of the CD is clean
- 3 Make sure function switch is set to CD position.
- 4 Make sure the CD is not blank.

Will not record

- 1 Make sure you are using a CD-R or CD-RW CD.
- 2 Check that the CD is blank.

Turntable has low volume

- 1 Remove and reinstall the stylus.

LIMITED MANUFACTURERS WARRANTY

Crosley Radio, Inc. warrants the product to be free from defects in material and workmanship under normal use for a period of one year from the original date of purchase. This warranty is not transferable. If the product is determined to be defective during the warranty period, the unit will be repaired or replaced at Crosley Radio's sole discretion. This warranty covers manufacturing defects and normal consumer use and does NOT cover damage or failure as a result of abuse, accident, alterations, misuse, neglect, abnormal wear and tear, inadequate maintenance, commercial or unreasonable use, damage caused by power surges, mishandling, accident, acts of God or attempted repair by an unauthorized service agent. Also not covered are cosmetic damages, cords and antennas.

Should this product fail to function in a satisfactory manner, it is best to first return it to the store or retailer where it was originally purchased. If additional service is still needed, the original purchaser must **FIRST** contact our offices to obtain an RA (Return Authorization) Number.

TO OBTAIN AN RA NUMBER
CALL: **1.888.CROSLEY**
(1.888.276.7539)

Send the unit prepaid to the address below in the original packaging (or reasonable substitute to prevent damage). Clearly mark your RA number on the outside packaging and include the original sales receipt (or a copy) indicating date of purchase, amount paid, and place of purchase. You must also include your full name, shipping address and daytime contact number. Please include a check or money order in the amount of \$19.95, made payable to Crosley Radio, to cover handling and return shipping charges. Returned products will not be shipped to PO Boxes. Crosley Radio will not be responsible for delays or unprocessed claims resulting from a purchaser's failure to provide any or all of the necessary information.

CROSLEY RADIO
ATTN: RETURNS DEPT
2001 PRODUCTION DRIVE
Louisville, KY 40299

For additional support: Crosley Radio Consumer Service Department
24 hours a day / 7 days a week
Telephone: 1.888.CROSLEY (1.888.276.7539)

*There are no express warranties except as listed above.
The purchaser's bill of sale is the only proof of warranty entitlement.*

This warranty gives the purchaser specified legal rights in addition to any rights which may vary from state to state.

In accordance with the "Moss-Magnuson Warranty Act" of July 10, 1975, this is termed a "limited warranty" which in no way compromises Crosley Radio's high standards of quality and workmanship.

Free Manuals Download Website

<http://myh66.com>

<http://usermanuals.us>

<http://www.somanuals.com>

<http://www.4manuals.cc>

<http://www.manual-lib.com>

<http://www.404manual.com>

<http://www.luxmanual.com>

<http://aubethermostatmanual.com>

Golf course search by state

<http://golfingnear.com>

Email search by domain

<http://emailbydomain.com>

Auto manuals search

<http://auto.somanuals.com>

TV manuals search

<http://tv.somanuals.com>