

WARRANTY

Crosley Radio Products are warranted against defects in material and workmanship for a period of 90 days beginning from the date of sale to the original purchaser.

Should the unit fail under normal usage during the 90 day warranty period, a request for RETURN AUTHORIZATION (R.A.) must be made by the original customer before returning the unit. Call Crosley Radio customer service for Return Authorization at (502) 583-4246 from 9 AM to 5 PM (EST) Monday to Friday.

Upon receiving the RETURN AUTHORIZATION number from the Customer Service Department, properly pack your unit in its original packaging. Include any adapters, parts, & accessories which were originally provided with the product, along with a check or money order for \$19.95 made out to Crosley Radio to cover the handling and return postage. Display the R.A. # on the outside of the carton and ship PREPAID via standard UPS or its equivalent.

CROSLEY
RADIO

ATTN: RETURNS DEPT
2001 PRODUCTION DRIVE
BAY 2 & 3
LOUISVILLE, KY 40299

CROSLEY RADIO assumes no responsibility for units sent without prior Return Authorization.

The purchaser's bill of sale is the only proof of warranty entitlement and must accompany the unit.

The warranty does not cover damage due to acts of nature, accident, misuse, abuse, negligence, commercial use or modification of, or to any part of the product. This warranty does not cover damage due to improper operation or maintenance, connection to improper voltage supply, or attempted repair by anyone other than a facility authorized by Crosley Radio to service the product. This warranty does not cover products sold AS IS or consumables (such as fuses or batteries). This warranty is valid only in the United States.

This warranty gives the purchaser specified legal rights in addition to any rights which may vary from state to state.

In accordance with the "Moss-Magnuson Warranty Act" of July 10, 1975, this is termed a "limited warranty" which in no way compromises Crosley Radio, high standards of Quality and Workmanship.

CROSLEY
RADIO

CR79

The Entertainer with Recorder

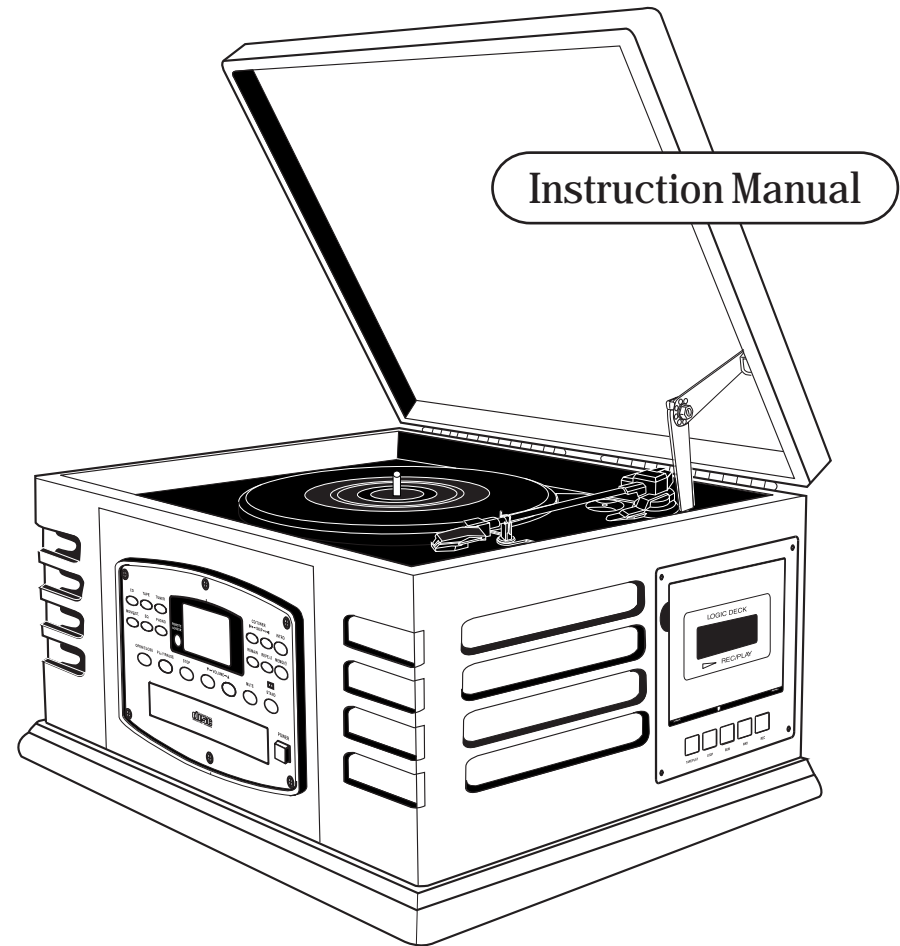

IMPORTANT SAFETY INSTRUCTION

PLEASE READ CAREFULLY ALL THE FOLLOWING IMPORTANT SAFEGUARDS THAT ARE APPLICABLE TO YOUR EQUIPMENT

1. Read Instructions - All the safety and operating instructions should be read before the product is operated.
2. Retain instructions - The safety and operating instructions should be retained for future reference.
3. Heed Warnings - All warnings on the product and in the operating Instructions should be adhered to.
4. Follow Instructions - All operating and use instructions should be followed.
5. Cleaning - Unplug this product from the wall outlet before cleaning. Do not use liquid cleaners or aerosol cleaners. Use a damp cloth for cleaning.
6. Attachments - Do not use attachments not recommended by the product manufacturer as they may cause hazards.
7. Water and Moisture - Do not use this product near water - for example, near a bath tub, wash bowl, kitchen sink, or laundry tub; in a wet basement; or near a swimming pool; and the like.
8. A product and cart combination should be moved with care. Quick stops, excessive force, and uneven surfaces may cause the product and cart combination to overturn.
9. Ventilation - Slots and openings in the cabinet are provided for ventilation and to ensure reliable operation of the product and to protect it from overheating, and these openings must not be blocked or covered. The openings should never be blocked by placing the product on a bed, sofa, rug, or other similar surface. This product should not be placed in a built-in installation such as a bookcase or rack unless proper ventilation is provided or the manufacturer's instructions have been adhered to.
10. Power Sources - This product should be operated only from the type of power source indicated on the marking label, if you are not sure of the type of power supply to your home. Consult your product dealer or local power company. For products intended to operate from battery power, or other sources, refer to the operating instructions.
11. Grounding or Polarization - This product may be equipped with a polarized alternating-current line plug (a plug having one blade wider than the other). This plug will fit into the power outlet only one way. This is a safety feature. If you are unable to insert the plug fully into the outlet try reversing the plug. If the plug should still fail to fit, contact your electrician to replace your obsolete outlet. Do not defeat the safety purpose of the polarized plug.
12. Power - Cord Protection - Power - supply cords should be routed so that they are not likely to be walked on or pinched by items placed upon or against them, paying particular attention to cords at plugs, convenience receptacles, and the point where they exit from the product.
13. Lightning - For added protection for this product during a lightning storm, or when it is left unattended and unused for long periods of time, unplug it from the wall outlet and disconnect the antenna or cable system. This will prevent damage to the product due to lightning and power - line surges.
14. Power Lines - An outside antenna system should not be located in the vicinity of overhead power lines or other electric light or power circuits, or where it can fall into such power lines or circuits. When installing an outside antenna system, extreme care should be taken to keep from touching such power lines or circuits as contact with them might be fatal.
15. Overloading - Do not overload wall outlets, extension cords, or integral convenience receptacles as this can result in a risk of fire or electric shock.
16. Object and Liquid Entry - Never push objects of any kind into this product through openings as they may touch dangerous voltage points or short - out parts that could result in a fire or electric shock. Never spill liquid of any kind on the product.
17. Servicing - Do not attempt to service this product yourself as opening or removing covers may expose you to dangerous voltage or other hazards. Refer all servicing to qualified service personnel.
18. Damage Requiring Service - Unplug this product from the wall outlet and refer servicing to qualified service personnel under the following conditions:
 - a. When the power-supply cord or plug is damaged.
 - b. If liquid has been spilled, or objects have fallen into the product.
 - c. If the product has been exposed to rain or water.
 - d. If the product does not operate normally by following the operating instructions. Adjust only those controls that are covered by the operating instructions as an improper adjustment of other controls may result in damage and will often require extensive work by a qualified technician to restore the product to its normal operation.
 - e. If the product has been dropped or damaged in any way.
 - f. When the product exhibits a distinct change in performance - this indicates a need for service.
19. Replacement Parts - When replacement parts are required, be sure the service technician has used replacement parts specified by the manufacturer or have the same characteristics as the original part. Unauthorized substitutions may result in fire, electric shock, or other hazards.
20. Safety Check - Upon completion of any service or repairs to this product, ask the service technician to perform safety checks to determine that the product is in proper operating condition.
21. Wall or ceiling Mounting - The product should be mounted to a wall or ceiling only as recommended by the manufacturer.
22. Heat - The product should be situated away from heat sources such as radiators. Heat registers, stoves, or other products (including amplifiers) that produce heat.

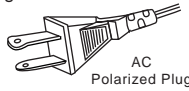

WARNING: Changes or modifications to this unit not expressly approved by the party responsible for compliance could void the user's authority to operate the equipment.

NOTE: This equipment has been tested and found to comply with the limits for a Class B digital device, pursuant to Part 15 of the FCC Rules. These limits are designed to provide reasonable protection against harmful interference in a residential installation. This equipment generates, uses, and can radiate radio frequency energy and, if not installed and used in accordance with the instructions, may cause harmful interference to radio communications. However, there is no guarantee that interference will not occur in a particular installation. If this equipment does cause harmful interference to radio or television reception, which can be determined by turning the equipment off and on, the user is encouraged to try to correct the interference by one or more of the following measures:

- Reorient or relocate the receiving antenna.
- Increase the separation between the equipment and receiver.
- Connect the equipment into a circuit different from that to which the receiver is connected.
- Consult the dealer or an experienced radio TV technician for help.

General

Trouble Shooting

There is no power

- 1 Make sure AC Plug is plugged in correctly.
- 2 Look at the STANDBY light and check to see if it is red and LCD displays on the screen..
- 3 Then press the POWER button. It will turn on the set and LCD back light will on.

There is no sound

- 1 Make sure the mute function is turned off.
- 2 Check that the volume is turned up by pressing VOL+ button on the control panel or on the remote.

Note: Volume range on some units start at level 15 and ends at level 40.
- 3 Make sure **ext./int.** switch on back of radio is on int. (unless you are using external speakers, in which case it should be on ext.)

- 4 Check to make sure power is turned on.

CD does not play

- 1 Check to make sure CD is inserted correctly (label side facing up).
- 2 Check to see that surface of CD is clean.
- 3 Make sure the unit is on CD mode by pressing CD on the control panel.

Remote not working

- 1 Replace batteries.
- 2 Be sure to point the remote towards remote sensor when operating.
- 3 Remove obstacles in the path of the remote and the unit so the remote signal has a straight path to the unit.

Turntable will not work

- 1 Check that the unit is in PHONO mode.
- 2 Try moving the tone arm to the right until you hear a click.

Control keys will not work

- 1 If the control keys will not work after lighting or power-Line surges, unplug the AC plug to reset the unit.

WARNING:

TO PREVENT FIRE OR SHOCK HAZARD, DO NOT EXPOSE THIS APPLIANCE TO RAIN OR MOISTURE. DO NOT REMOVE COVER. PILOT LAMPS SOLDERED IN PLACE. NO USER SERVICEABLE PARTS INSIDE. REFER SERVICING TO QUALIFIED SERVICE PERSONNEL.



The lightning flash with arrowhead symbol, within an equilateral triangle, is intended to alert user to the presence of uninsulated "dangerous voltage" within the product's enclosure that may be of sufficient magnitude to constitute risk of electric shock to persons.

CAUTION

**RISK OF ELECTRIC SHOCK
DO NOT OPEN**

CAUTION: TO REDUCE THE RISK OF ELECTRIC SHOCK, DO NOT REMOVE COVER (OR BACK). NO USER - SERVICEABLE PARTS INSIDE. REFER SERVICING TO QUALIFIED SERVICE PERSONNEL.



The exclamation point within an equilateral triangle is intended to alert user to the presence of important operating and maintenance (servicing) instruction in the literature accompanying the appliance.

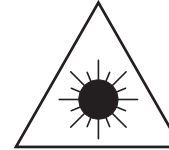

CAUTION

For Compact Disc Units Only:

INVISIBLE LASER RADIATION WHEN OPEN AND INTERLOCK FAILED OR DEFEATED. AVOID DIRECT EXPOSURE TO LASER BEAM.

Specification

Frequency Range	: AM 520 - 1710 KHz
	: FM 87.5 - 108 MHz
Power Consumption	: 18 Watts
Antennas	: External FM antenna
	: Built-in ferrite AM bar
Power Source	: AC 120V ~ 60 Hz
Speaker	: 4" Dynamic type X 2
Speaker Wattage	: 5 Watts
Speaker ohms	: 8 ohms
Output ohms	: 8 ohms
Output Wattage	: 2 Watts per channel

* DESIGN AND SPECIFICATIONS SUBJECT TO CHANGE WITHOUT NOTICE.

Welcome

Thank you for purchasing the Crosley The Entertainer with Recorder (CR79). Before operating this unit, please read this manual thoroughly and retain it for future reference.

About This Manual

Instructions in this manual describe the control functions of the CR-79 along with the functions of the remote control.

Table of Contents

Getting Started	
Control Locators.....	4-5
Unpacking.....	6
Set Up.....	6
Basic Operation	
Power Up Your Crosley.....	7
Functions.....	7
Clock Operation	
Clock Operation.....	8
Sleep Operation.....	8
Timer-On Operation.....	9
Timer-Off Operation.....	10
CD Player	
CD Door Open / Close.....	11
Play.....	11
Remain time display.....	11
Pause.....	12
Stop.....	12
FF/FB and FS/BS.....	12
CD Player & Connecting Optional Equipment	
Program.....	13
Random / Repeat	14
Turntable & Radio	
Setting turntable speed.....	15
Playing a record.....	15
Manual Tuning.....	15
Auto Tuning.....	15
Radio	
Load Preset channel.....	16
Save preset.....	16
Mono / Stereo.....	16
Signal.....	16
Logic Deck	
Play.....	17
Stop.....	17
Phono Mode manual recording.....	17
Tuner mode manual record.....	17
CD mode manual record (Normal Play)...	18
FWD/REW.....	18
Recording/Earsing.....	19
CD mode manual record (Pause).....	19
Timer-on Syn. record.....	20
Beat-cut.....	20
Warning.....	20
General	
Trouble Shooting.....	21

Logic Deck

Timer-On Syn. Record

- A** After set the target timer-on time, source selection menu will show for selecting the sync. record source.
- B** CD, TUNER and AUX/PHONO source can be selected
- C** After selected the sync. record source, the "SYNC" icon will show up

Notes:

- 1) Tape must recordable
- 2) Tape must in logic deck

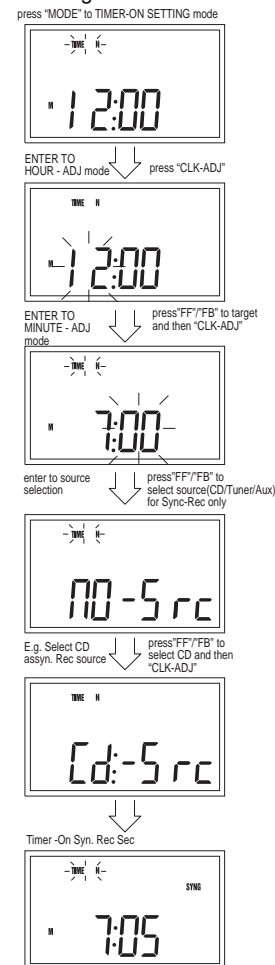

Beat-cut

Beat-Cut

- A** Press "BEAT" to change the recording oscillator frequency

Notes: 1) Beat-cut only can change in TUNER Mode

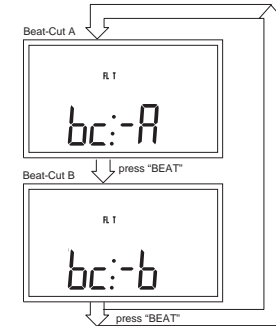

Warning

When AC main power is off at tape PLAY/REC Mode, the Tape will be locked and the tape door can not be opened. It should be released by REW key or PLAY key with power on before opening the tape door.

Recording/Erasing

Tape Mode manual recording

A In STOP MODE, press and hold "TAPE REC" 2 sec to start the recording processes

Notes:

- 1) Tape must recordable
- 2) Tape must in stop mode
- 3) Within the 2 sec key holding time, the "REC" icon will flash
- 4) During recording mode, FWD/REW/PLAY cannot execute
- 5) If recording is performed in TAPE mode, the tape erasing process is executed

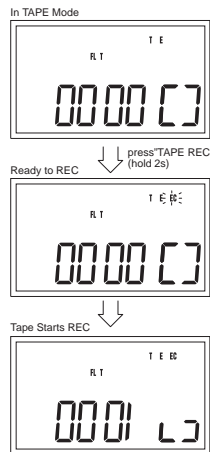

CD Mode Manual record (Pause)

A In STOP mode, press and hold "TAPE REC" 2 sec to start the recording processes

B Press "REC" key for Pause mode during recording.

C Press REC/PAUSE mode will release and resume recording.

Notes:

- 1) Tape must recordable
- 2) Tape must in STOP mode
- 3) Within the 2 sec key holding time, the "REC" icon will flash
- 4) During recording mode, FWD/REW/PLAY cannot execute

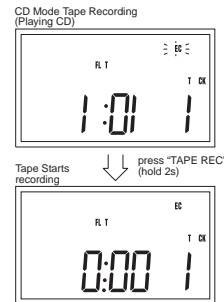

Unit Controls

- 1 CD-Play / Pause
- 2 Phono
- 3 Tuner / Band
- 4 Remote Sensor
- 5 LCD Display
- 6 Backward Skip/ Search (CD / Tuner)
- 7 Forward Skip/ Search (CD / Tuner)
- 8 Prog / Clk - adj
- 9 Random/ Preset -
- 10 Repeat / Preset +
- 11 Standby Indicator
- 12 Remain / Mode
- 13 Power
- 14 CD Door
- 15 Intro / Mono / Stereo
- 16 Equalizer (EQ)
- 17 Timer / Sleep
- 18 Control Panel
- 19 Open/ Close
- 20 CD Stop
- 21 Signal (For Radio)
- 22 Beat Cut (For Radio)
- 23 Mute
- 24 Volume Down
- 25 Volume Up
- 26 Turntable
- 27 Spindle
- 28 Adapter For 45 rpm Records
- 29 Tone Arm
- 30 Speed Control Switch
- 31 Arm Rest
- 32 Needle
- 33 AC Power Cord
- 34 External FM Antenna
- 35 Speaker Internal/ External Switch
- 36 Speaker Jack
- 37 Tape Play
- 38 Tape Stop
- 39 Tape Rewind
- 40 Tape Forward / Rec Counter
- 41 Rec / Rec Pause
- 42 Cassette Door

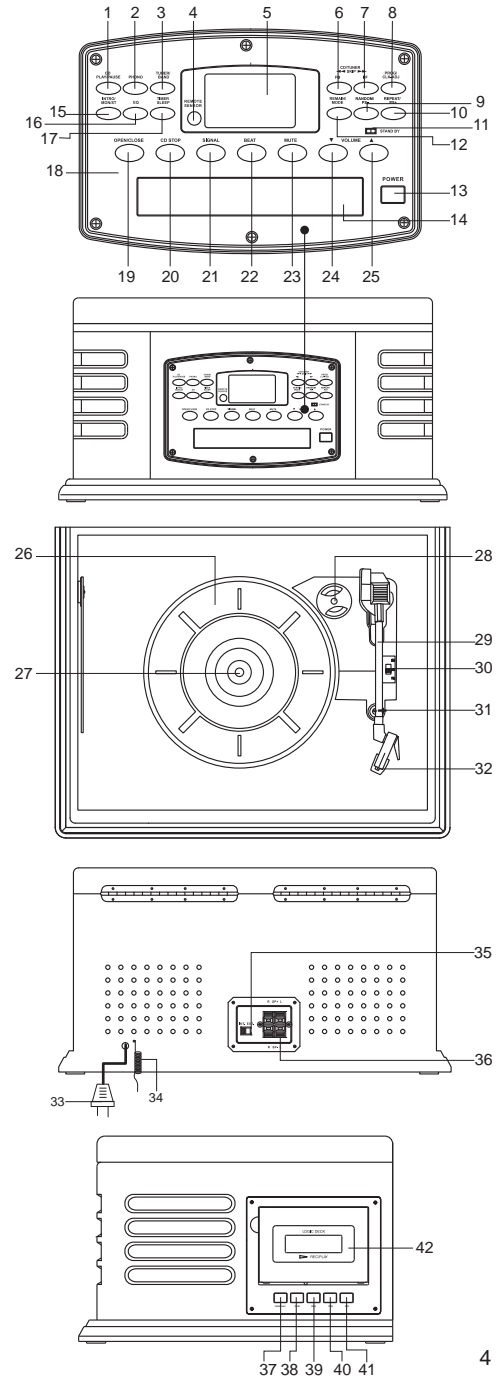

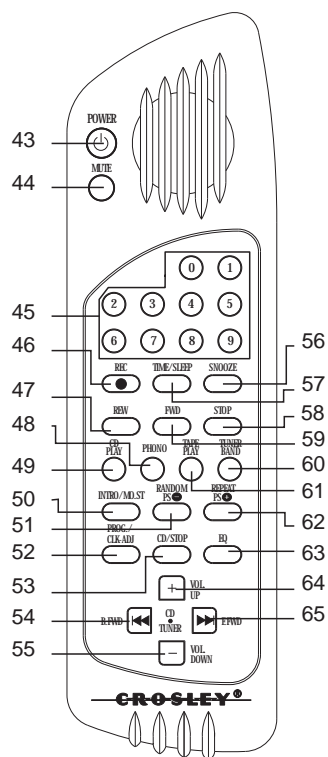

Remote Controls

- 43 Power
- 44 Mute
- 45 Number 0,1-9
- 46 Rec (Tape Pause)
- 47 Rew
- 48 Phono
- 49 CD Play
- 50 Intro / Mono / Stereo
- 51 Random / PS-
- 52 Prog. / CLK-ADJ
- 53 CD / Stop
- 54 B.FWD (CD/TUNER)
- 55 Vol Down
- 56 Snooze
- 57 Time / Sleep
- 58 Stop
- 59 FWD (Rec Tape Counter)
- 60 Tuner / Band
- 61 Tape Play
- 62 Repeat / PS +
- 63 EQ
- 64 Vol Up
- 65 F.FWD (CD/TUNER)

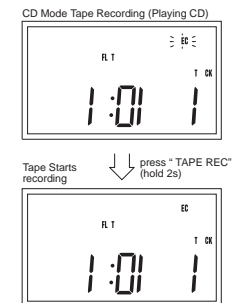
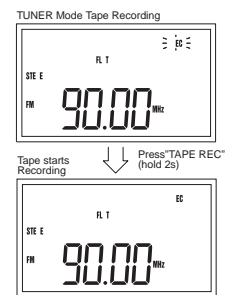

CD Mode Manual record (Normal Play)

SYNC RECORDING AT THE BEGINNING OF THE SONG

- 1) Play the song that you want to record at CD mode.
- 2) Press and hold "TAPE REC" key 2 sec. to start the recording process
- 3) The CD will go back at the beginning of the song. And start to recording.

SYNC RECORDING AT ANY POSITION OF THE CD

- 1) During CD playback press "CD PLAY/PAUSE" key to pause at the position that you want to record.
- 2) Press and hold "TAPE REC" key 2 sec to start the recording process position.

Notes:

- 1) Tape must recordable
- 2) Within the 2 sec key holding time, the "REC" icon will flash
- 3) During recording mode, FWD/REW/PLAY cannot execute
- 4) Press "TAPE FWD" to change the LCD display to show tape counter display during recording.
- 5) Press "TAPE REC" Key for PAUSE mode, the "REC" icon will flash on the LCD display

FWD/REW

A In STOP/PLAY mode, press forward or rewind operation

Notes: 1) FWD/REW can execute in TUNER/CD/PHONO/ TAPE mode

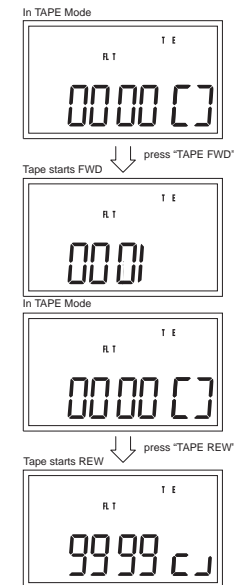

Logic Deck

Play

Press the "TAPE/PLAY" button to enter logic deck mode.

- a) In STOP/FWD/REW mode, press "TAPE PLAY" to start tape play

Notes: 1) Play only can perform in TAPE mode

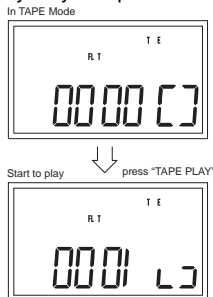

Stop

- A In PLAY/REC/FWD/REW mode, press "TAPE STOP" to perform stop operation

Notes: 1) From tape recording to STOP mode, the "REC" icon will turn-off

- A In Stop mode, press "TAPE STOP" to reset the tape counter

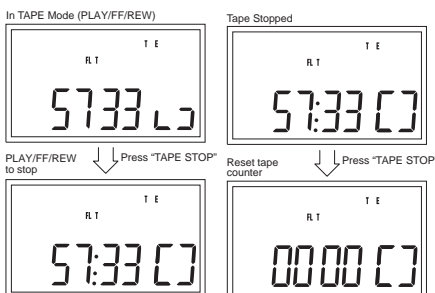

Phono Mode manual recording

- A In Stop mode, press and hold "TAPE REC" 2sec to start the recording processes

Notes:

- 1) Tape must recordable
- 2) Tape must in Stop mode
- 3) Within the 2 sec key holding time, the "REC" icon will flash
- 4) During RECORDING mode, FWD/REW/PLAY.
- 5) Press "TAPE FORWARD" to change the LCD display to show tape counter display during Recording.
- 6) Press "TAPE REC" Key for Pause mode, during Recording and the "REC" icon will flash on the LCD display

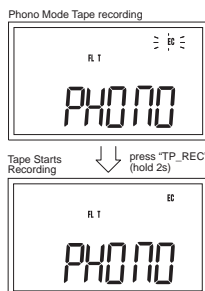

Tuner Mode manual record

- A In Stop mode, press and hold "TAPE REC" 2 sec to start the recording processes

Notes:

- 1) Tape must recordable
- 2) Tape must in stop mode
- 3) Within the 2 sec key holding time, the "REC" icon will flash
- 4) During RECORDING mode, FWD/REW/PLAY cannot execute

Getting Started

Unpacking

- 1 Remove packing materials from unit.
Note: Save all packing materials.
- 2 Remote control is located in the outside of the styrofoam packaging.
- 3 Remove plastic bag covering radio and remote control.
- 4 Remove plastic safety cover from A/C plug.
- 5 Remove tie from A/C cord and untie antenna wire on back of radio.
- 6 Open lid and remove styrofoam shipping material from turntable.
- 7 Remove black tie-wrap from under the tone arm.
- 8 Remove white protective needle cover by gently pulling towards the front of the unit.

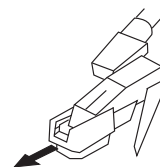

Set Up

- 1 Install 2 AAA batteries (not included) in remote control.
- 2 Plug A/C cord into appropriate outlet.

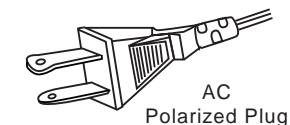

Note: This product may be equipped with a polarized alternating-current line plug (a plug having one blade wider than the other.) This plug will fit into the power outlet only one way. This is a safety feature. If you are unable to insert the plug fully into the outlet try reversing the plug, if the plug should still fail to fit, contact your electrician to replace your obsolete outlet. Do not defeat the safety purpose of the polarized plug.

- 3 Untie the FM antenna and allow it to hang down in a straight line for optimum FM reception. If you have trouble tuning in an FM station, move the external FM antenna for best reception. Do not connect FM antenna to outside antenna.

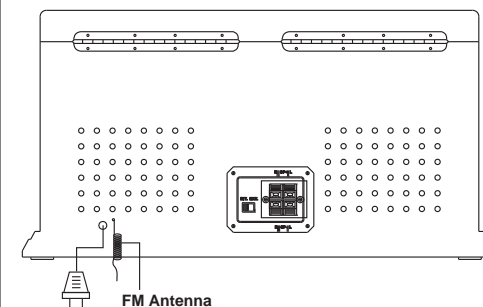

Powering Up Your Crosley

Your new Crosley is equipped with a POWER / STANDBY button. Press the POWER / STANDBY button on either the front of the unit or on your remote control. The Standby light will turn from red to green. When turned off, the standby light will turn red. During standby mode, all presets will remain programmed in your unit.

Functions

Electronic Volume Control

- 1 Press the "VOL+" button to increase the volume. The volume level will be shown in the LCD display.

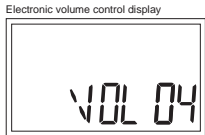

Note: Volume range for this units start at level 0 and end at level 40.

- 2 Press the "VOL-" button to decrease the volume.
- 3 Press and hold either the "VOL+" or the "VOL-" button to continuously increase or decrease the volume. The volume will continue to increase or decrease until the button is released.
- 4 Press the "MUTE" button to set the volume to 0. Press the "MUTE" button again to return to the previous volume level.

Functions (cont.)

Function Select

- 1 Press the "TUNER/BAND" button to enable the AM/ FM tuning function. When in TUNER mode, the LCD will display the band (AM/FM), and the station frequency.

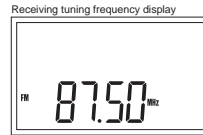

- 2 Press the "CD" button to set to CD mode. When first set to CD mode, the display will search for CD and track information.

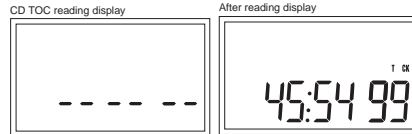

- 3 Press the "PHONO" button to set to PHONO mode. When in PHONO mode, the display will read "PHONO".

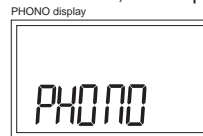

- 4 Press the "TAPE" button to set to CASSETTE mode. The display will read "COUNTER" when in cassette mode.

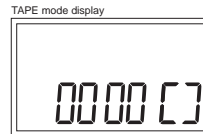

Equalizer

- 1 This unit has a built in equalizer. The equalizer fine tunes the sound according to the type of music you like. Pressing the EQ button results in the following changes:

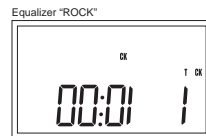

Load Preset Channel

Load up and down correspond to "PS+" and "PS-" key, respectively.

- A Press "PS+" or "PS-" to recall preset channel

Notes: 1) the current display frequency will not be kept during above operation.

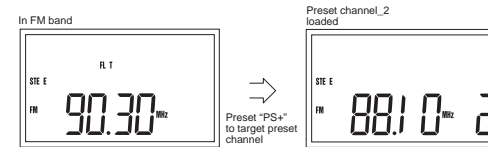

Save Preset

Channel number select up or down correspond to "PS+" and "PS-" key, respectively.

- In TUNER mode, choose a station that you want to save. Press "PROG" to enter programming mode.--) will flash.
- Press "PS+" or "PS-" to desired preset number (e.g. channel-10).
- Press "PROG" to save that station.
- Repeat above procedure.

Notes: 1) The original preset of channel-2 will not be changed during above operation.

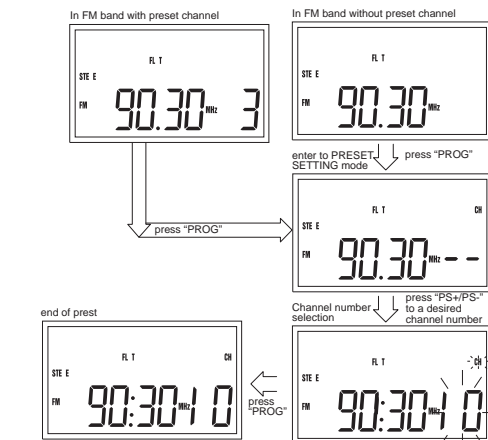

Mono/Stereo

- Press "MO/ST" to toggle the type of FM signal.

Notes: 1. Only for FM band
2. If stereo signal is too weak, 'STEREO' icon will not appear. Press this key change to Mono mode. The reception may be improved.

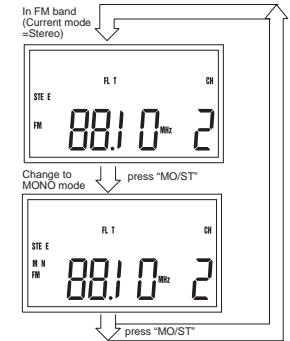

Signal

A high-pitched noise called BEAT is sometime heard during reception of radio broadcast.

- Press "SIGNAL" until find a best quality of signal.

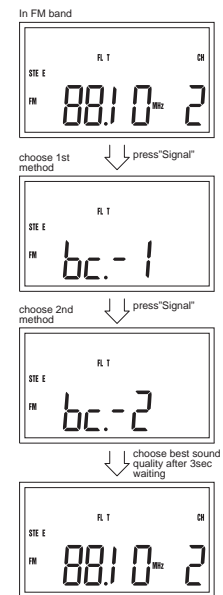

Turntable & Radio

Setting Turntable Speed

- 1 Press the "PHONO" button on the control panel to set the turntable mode. If playing a 45 rpm record, use the 45 rpm adapter supplied with the turntable.
- 2 Use the speed selector on the turntable to set the rpm to the appropriate speed for the selected record.

Playing a Record

- 1 First, remove the white protective needle cover. Gently lift the tone arm off its rest.
- 2 Move the tone arm slowly to the right side until you hear a click. The turntable should start turning once the click is heard.
- 3 Move the tone arm to the left and lower it gently onto the record to start playing.
- 4 At the end of the record, the turntable will stop turning.
- 5 Lift the tone arm from the record and return it to the arm rest.

Manual Tuning

Press the "TUNER/BAND" button to enable the AM/FM tuning function.

Tune-up and tune-down correspond to "FF" and "FB" key, respectively.

- A** Press "FF" or "FB" and then release key within 1 sec.

Notes: 1) The memory of preset channel-2 will not be changed during above operation.

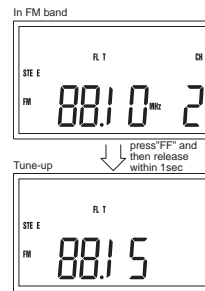

Auto Tuning

Tune-up and tune-down correspond to "FF" and "FB" key, respectively.

- B** Hold "FF" or "FB" over 1 sec and then release it at any time.
- C** After key release, the auto-tuning operation will start until find a station.

Notes: 1) The memory of preset channel-2 will not be changed during above operation.

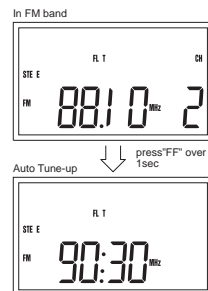

You can store up to 24 FM stations and 16 AM station into the preset memory.

Clock Operation

Clock Operation

Assume the system is OFF.

- A** Press "CLK-ADJ", enter to hour ADJUSTMENT mode.
- B** Press "FF / FB" to set hour. (e.g 8:00am -> 10:00pm).
- C** Press "CLK-ADJ", enter to minute ADJUSTMENT mode.
- D** Press "FF" or "FB" to set minutes. (e.g 10:39pm -> 10:45pm).
- E** Press "CLK-ADJ", finish clock adjustment.

Notes: 1) 12 / 24 hour display mode can be adjusted during hour or minute adjustment mode by using "TIMER".

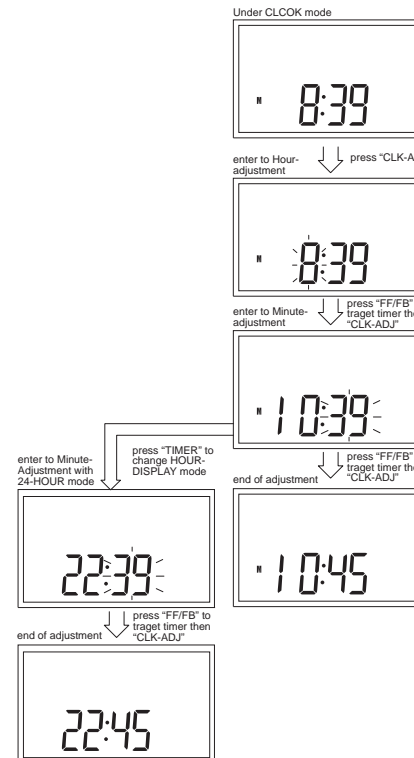

Sleep Operation

Sleep time step change for each pressing:

- 00 → cancel sleep function
- non-zero → sleep function activate

- A** Press "SLEEP" to desired time for count-down.

Notes: 1) When count-down time reaches zero, the system will automatically turn OFF.

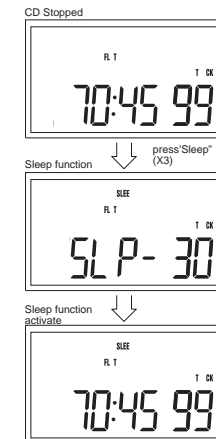
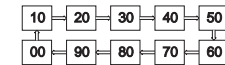

Clock Operation

Timer-On Operation

Example: "Set Timer-On for 7:05 am."

- A** Press "MODE" to timer-on display mode.
- B** Press "CLK-ADJ" to enter to timer-on hour adjustment mode.
- C** Press "FF / FB" to set desired hour. (e.g. 12:00am → 7:00am)
- D** Press "CLK-ADJ" to enter to timer-on minute - adjustment mode.
- E** Press "FF / FB" to set desired minute. (e.g. 7:00am → 7:05am)
- F** Press "CLK-ADJ" to enter to recording source mode.
- G** For Non-Timer-Recording, select 'No-Src'. If Timer-Recording require select a particular source (CD/TUNER/PHONO).
- H** Press "CLK-ADJ" to return to timer-on display mode with activation of Timer-on function.

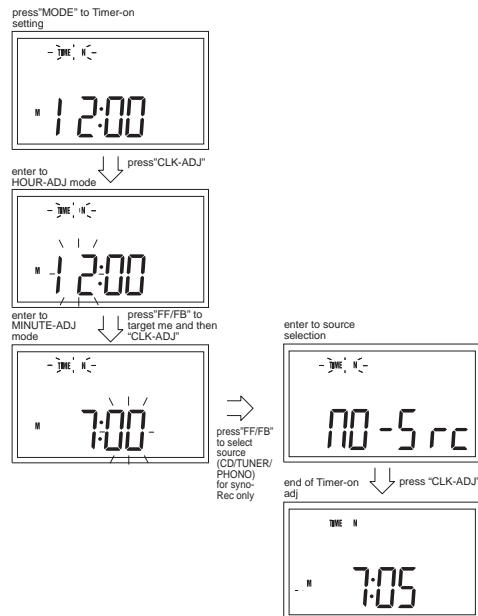

- A** Press "TIMER" to deactivate (both icons flash) or activate (only 'Timer' flash) Timer-on function.

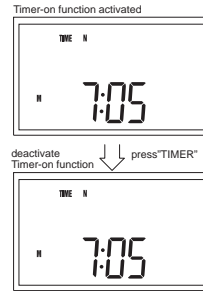

CD Player & Connecting Optional Equipment

Repeat

To repeat playback of a single track or the whole disk, press the "REPEAT" button. Pressing this button once will repeat only the selected track and a flashing "REPEAT" will appear on the display. Pressing the "REPEAT" button twice will repeat the whole CD when it reaches the end and repeat will appear but will not flash. Pressing "REPEAT" a third time will turn off the repeat function.

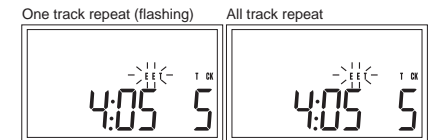

Optional External Speakers

- 1 With your new radio, you have the option of adding external speakers.
- 2 The speaker jacks for external speakers are located on the back of the radio. Along with the speaker jacks is a switch labeled int./ ext. When using external speakers, this switch must be switched to the ext. position. Doing this turns off the internal speakers in the radio and redirects the power to the external speakers.
- 3 If you decide not to use the external speakers, be sure the switch is on int. or the internal speakers will not work.

Random

- A** In the stop or play mode, Press "RANDOM" to activate or deactivate the random function.

Notes:

- 1) It can work with "INTRO", "REPEAT" and "REMAIN".
- 2) The random function will not clear except press "STOP" twice or press "PROG" in STOP mode.

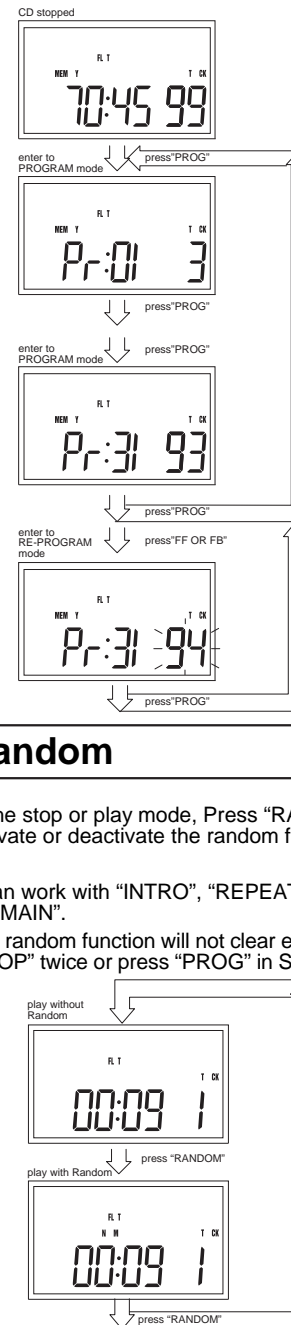

CD Player & Connecting Optional Equipment

Program

Track programming

- A** While CD is stopped, press "PROG" to enter PROGRAM mode.
- B** Press "FF" or "FB" to select a desired track number.
- C** Press "PROG" to save that track.
- D** Repeat above procedures to program additional tracks.
- E** After end of program, press "PLAY" to start playback.

Notes: .
1) To program, the CD must be stopped.

2) The same track can be programmed more than once.

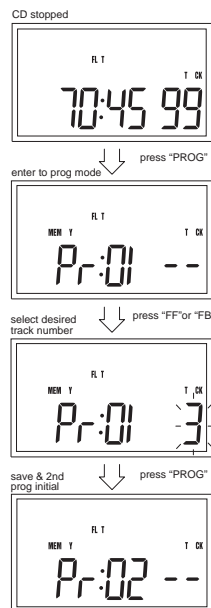

Programmed track revision

- A** While CD is stopped, press "PROG" button to check the sequence of programmed tracks.
- B** After checking, just press "PLAY" to start play.

Notes: 1) Clear programming process by using of "STOP".

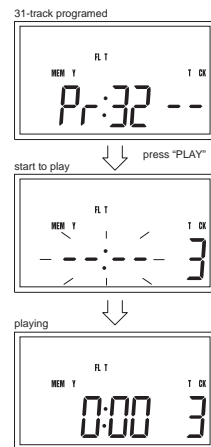

Add or Change program track

- A** While CD is stopped, press "PROG" repeatedly to reach the program number that you want to change.
- B** Press "FF" or "FB" to desire track.
- C** Press "PROG" to save.
- D** Repeat above procedures to add or change program track.

Notes:

- 1) It can work with "INTRO", "REPEAT" during play.
- 2) The programmed contents will not clear except press "STOP" twice or press "RANDOM".

Clock Operation

Timer-Off Operation

Example: "set Timer - off for 8:15am"

- A** Press "MODE" to timer-off display mode.
- B** Press "CLK-ADJ" to enter to timer-off hour-adjustment mode.
- C** Press "FF / FB" to set desired hour. (e.g. 12:00am → 8:00am).
- D** Press "CLK-ADJ" to enter to timer-off minute-adjustment mode.
- E** Press "FF / FB" to set desired minute. (e.g. 8:00am → 8:15am).
- F** Press "CLK-ADJ" to return to timer-off display mode with activation of Timer-off function.

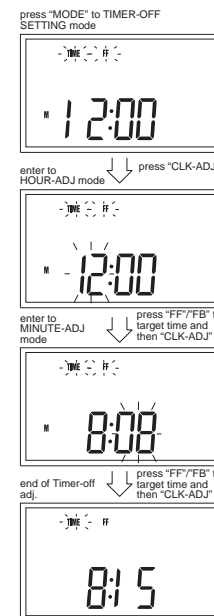

- A** Press "TIMER" to deactivate (both icons flash) or activate (only "Timer" flash) Timer-off function.

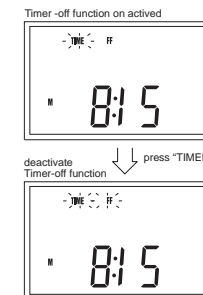

Snooze Operation

If using the Timer-On function, you can also use the Snooze function. Using the Snooze function will allow you to temporarily turn off the Timer-On function for 5 minutes.

- A** Press "SNOOZE" to turn off the system. After 5 minutes, the system will ON again automatically

Notes:

- 1) The function mode (CD/TUNER/AUX/TAPE) will not be changed for above operation.

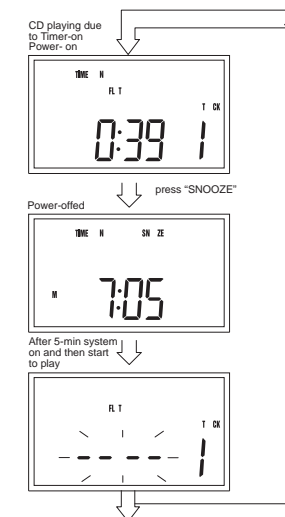

To Load A CD

- A** Press "CD" on control panel or on remote control to enter "CD" mode.
- B** Press the "OPEN/CLOSE" button to open the CD drawer.
- C** Load the CD with CD label facing up.
- D** Press the "OPEN/CLOSE" button to close the CD drawer.
- E** To remove CD, press the CD "STOP" button to stop CD from spinning. Press the "OPEN/CLOSE" button to open drawer. Remove CD and press the "OPEN/CLOSE" button to close the CD drawer.

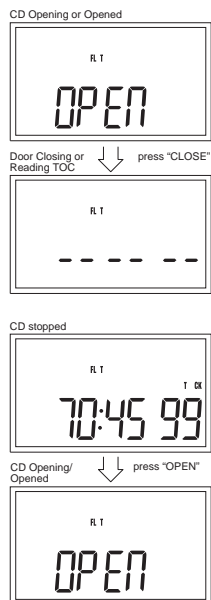

Play

- A** Press "PLAY" to start play

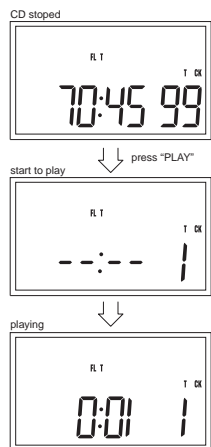

Remain time display

- A** During playback, press "REMAIN" until Remain icon appear.
- B** To cancel remain time display, press "REMAIN" until relative time show out.

This function will show you how much time is remaining on the CD.

Note: 1) It can work with 'INTRO' or 'REPEAT'.

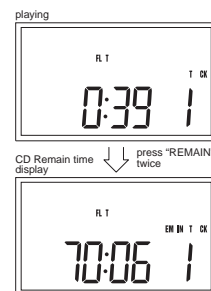

Pause

- A** During playback, press "PLAY" to pause.
- B** To resume play, press this key again.

Notes: 1) Pause function will be kept after "FF/FS" or "FB/BS".

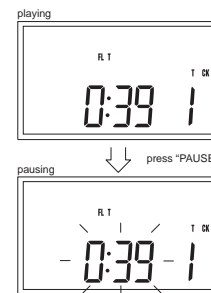

Stop

- A** During CD playback, press "STOP" to stop play and then total time and total tracks will show on the display.

Notes: "STOP" is a multi-function key.

1. Cancel programmed play, press "STOP" after CD stopped
2. Cancel repeat, intro, remain, random and / or programming mode.
3. Cancel selected track number (not yet play).
4. Stop tape during CD-Sync-Rec.

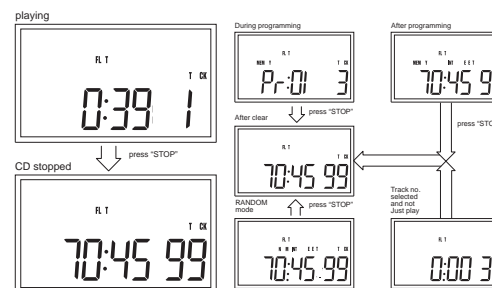

FF/FB and FS/BS

Track Skip

- A** select a particular track by using "FF" or "FB" (release key within 2 sec).

Track Scan

- A** Hold "FS" or "BS" more than 2 sec to perform scan.

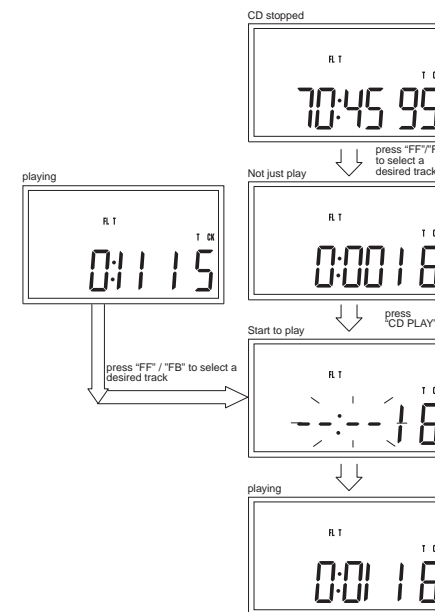

Free Manuals Download Website

<http://myh66.com>

<http://usermanuals.us>

<http://www.somanuals.com>

<http://www.4manuals.cc>

<http://www.manual-lib.com>

<http://www.404manual.com>

<http://www.luxmanual.com>

<http://aubethermostatmanual.com>

Golf course search by state

<http://golfingnear.com>

Email search by domain

<http://emailbydomain.com>

Auto manuals search

<http://auto.somanuals.com>

TV manuals search

<http://tv.somanuals.com>