

CROSLLEY
RADIO

CR66

ROCHESTER

Instruction Manual

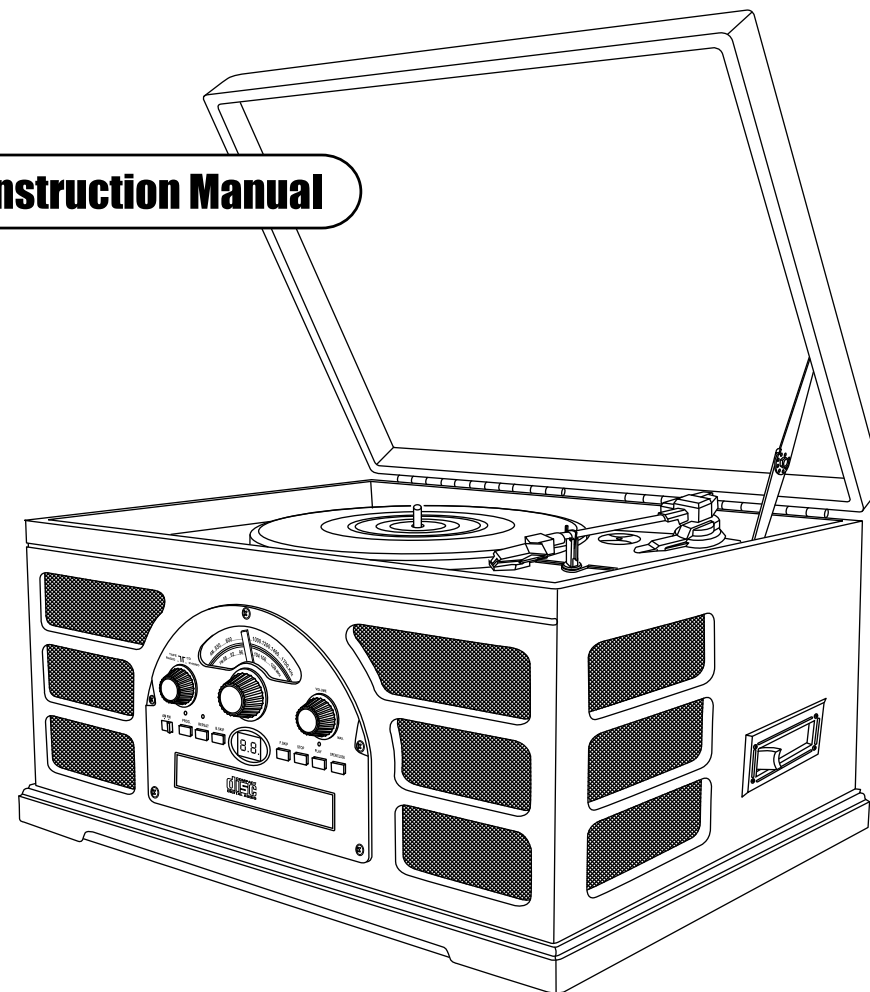

WARRANTY

Crosley Radio Products are warranted against defects in material and workmanship for a period of 90 days beginning from the date of sale to the original purchaser.

Should the unit fail under normal usage during the 90 day warranty period, a request for RETURN AUTHORIZATION (R.A.) must be made by the original customer before returning the unit. Call Crosley Radio customer service for Return Authorization at (502) 583-4246 from 9 AM to 5 PM (EST) Monday to Friday.

Upon receiving the RETURN AUTHORIZATION number from the Customer Service Department, properly pack your unit in its original packaging. Include any adapters, parts, & accessories which were originally provided with the product, along with a check or money order for \$19.95 made out to Crosley Radio to cover the handling and return postage. Display the R.A. # on the outside of the carton and ship PREPAID via standard UPS or its equivalent.

**CROSLEY
RADIO**

ATTN: RETURNS DEPT
2001 PRODUCTION DRIVE
BAY 2 & 3
LOUISVILLE, KY 40299

CROSLEY RADIO assumes no responsibility for units sent without prior Return Authorization.

The purchaser's bill of sale is the only proof of warranty entitlement and must accompany the unit.

The warranty does not cover damage due to acts of nature, accident, misuse, abuse, negligence, commercial use or modification of, or to any part of the product. This warranty does not cover damage due to improper operation or maintenance, connection to improper voltage supply, or attempted repair by anyone other than a facility authorized by Crosley Radio to service the product. This warranty does not cover products sold AS IS or consumables (such as fuses or batteries). This warranty is valid only in the United States.

This warranty gives the purchaser specified legal rights in addition to any rights which may vary from state to state.





In accordance with the "Moss-Magnuson Warranty Act" of July 10, 1975, this is termed a "limited warranty" which in no way compromises Crosley Radio, high standards of Quality and Workmanship.

WARNING:

To reduce the risk of fire or electric shock, do not expose this appliance to rain or moisture.

CAUTION:

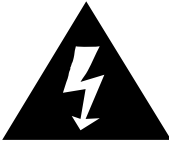
Use of controls or adjustments or performance of procedures other than those specified may result in hazardous radiation exposure.

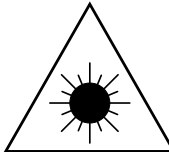
	CAUTION RISK OF ELECTRIC SHOCK DO NOT OPEN	
CAUTION: TO REDUCE THE RISK OF ELECTRIC SHOCK, DO NOT REMOVE COVER (OR BACK). NO USER - SERVICEABLE PARTS INSIDE. REFER SERVICING TO QUALIFIED SERVICE PERSONNEL.		
	The lightning flash with arrowhead symbol, within an equilateral triangle, is intended to alert user to the presence of uninsulated "dangerous voltage" within the product's enclosure that may be of sufficient magnitude to constitute risk of electric shock to persons.	
	The exclamation point within an equilateral triangle is intended to alert user to the presence of important operating and maintenance (servicing) instruction in the literature accompanying the appliance.	
	CAUTION For Compact Disc Units Only: INVISIBLE LASER RADIATION WHEN OPEN AND INTERLOCK FAILED OR DEFEATED. AVOID DIRECT EXPOSURE TO LASER BEAM.	

•Marking plate was located on bottom enclosure

Specification

Frequency Range	: AM 525 - 1710 KHz
	: FM 87.5 - 108.5 MHz
Power Supply	: AC 120V ~ 60Hz
Power Consumption	: 18W
Antennas	: External antenna for FM
	: Built-in ferrite bar for AM
Speaker	: 4" Dynamic type x 2

* DESIGN AND SPECIFICATIONS SUBJECT TO CHANGE WITHOUT NOTICE.

IMPORTANT SAFETY INSTRUCTION

PLEASE READ CAREFULLY ALL THE FOLLOWING IMPORTANT SAFEGUARDS THAT ARE APPLICABLE TO YOUR EQUIPMENT

1. Read Instructions - All the safety and operating instructions should be read before the product is operated.
2. Retain instructions - The safety and operating instructions should be retained for future reference.
3. Heed Warnings - All warnings on the product and in the operating Instructions should be adhered to.
4. Follow Instructions - All operating and use instructions should be followed.
5. Cleaning - Unplug this product from the wall outlet before cleaning. Do not use liquid cleaners or aerosol cleaners. Use a damp cloth for cleaning.
6. Attachments - Do not use attachments not recommended by the product manufacturer as they may cause hazards.
7. Water and Moisture - Do not use this product near water - for example, near a bath tub, wash bowl, kitchen sink, or laundry tub; in a wet basement; or near a swimming pool; and the like.
8. A product and cart combination should be moved with care. Quick stops, excessive force, and uneven surfaces may cause the product and cart combination to overturn.
9. Ventilation - Slots and openings in the cabinet are provided for ventilation and to ensure reliable operation of the product and to protect it from overheating, and these openings must not be blocked or covered. The openings should never be blocked by placing the product on a bed, sofa, rug, or other similar surface. This product should not be placed in a built-in installation such as a bookcase or rack unless proper ventilation is provided or the manufacturer's instructions have been adhered to.
10. Power Sources - This product should be operated only from the type of power source indicated on the marking label, if you are not sure of the type of power supply to your home. Consult your product dealer or local power company. For products intended to operate from battery power, or other sources, refer to the operating instructions.
11. Grounding or Polarization - This product may be equipped with a polarized alternating-current line plug (a plug having one blade wider than the other). This plug will fit into the power outlet only one way. This is a safety feature. If you are unable to insert the plug fully into the outlet try reversing the plug. If the plug should still fail to fit, contact your electrician to replace your obsolete outlet. Do not defeat the safety purpose of the polarized plug.
12. Power - Cord Protection - Power - supply cords should be routed so that they are not likely to be walked on or pinched by items placed upon or against them, paying particular attention to cords at plugs, convenience receptacles, and the point where they exit from the product.
13. Lightning - For added protection for this product during a lightning storm, or when it is left unattended and unused for long periods of time, unplug it from the wall outlet and disconnect the antenna or cable system. This will prevent damage to the product due to lightning and power - line surges.
14. Power Lines - An outside antenna system should not be located in the vicinity of overhead power lines or other electric light or power circuits, or where it can fall into such power lines or circuits. When installing an outside antenna system, extreme care should be taken to keep from touching such power lines or circuits as contact with them might be fatal.
15. Overloading - Do not overload wall outlets, extension cords, or integral convenience receptacles as this can result in a risk of fire or electric shock.
16. Object and Liquid Entry - Never push objects of any kind into this product through openings as they may touch dangerous voltage points or short - out parts that could result in a fire or electric shock. Never spill liquid of any kind on the product.
17. Servicing - Do not attempt to service this product yourself as opening or removing covers may expose you to dangerous voltage or other hazards. Refer all servicing to qualified service personnel.
18. Damage Requiring Service - Unplug this product from the wall outlet and refer servicing to qualified service personnel under the following conditions:
 - a. When the power-supply cord or plug is damaged.
 - b. If liquid has been spilled, or objects have fallen into the product.
 - c. If the product has been exposed to rain or water.
 - d. If the product does not operate normally by following the operating instructions. Adjust only those controls that are covered by the operating instructions as an improper adjustment of other controls may result in damage and will often require extensive work by a qualified technician to restore the product to its normal operation.
 - e. If the product has been dropped or damaged in any way.
 - f. When the product exhibits a distinct change in performance - this indicates a need for service.
19. Replacement Parts - When replacement parts are required, be sure the service technician has used replacement parts specified by the manufacturer or have the same characteristics as the original part. Unauthorized substitutions may result in fire, electric shock, or other hazards.
20. Safety Check - Upon completion of any service or repairs to this product, ask the service technician to perform safety checks to determine that the product is in proper operating condition.
21. Wall or ceiling Mounting - The product should be mounted to a wall or ceiling only as recommended by the manufacturer.
22. Heat - The product should be situated away from heat sources such as radiators, heat registers, stoves, or other products (including amplifiers) that produce heat.

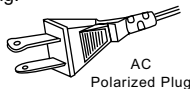

WARNING: Changes or modifications to this unit not expressly approved by the party responsible for compliance could void the user's authority to operate the equipment.

NOTE: This equipment has been tested and found to comply with the limits for a Class B digital device, pursuant to Part 15 of the FCC Rules. These limits are designed to provide reasonable protection against harmful interference in a residential installation. This equipment generates, uses, and can radiate radio frequency energy and, if not installed and used in accordance with the instructions, may cause harmful interference to radio communications. However, there is no guarantee that interference will not occur in a particular installation. If this equipment does cause harmful interference to radio or television reception, which can be determined by turning the equipment off and on, the user is encouraged to try to correct the interference by one or more of the following measures:

- Reorient or relocate the receiving antenna.
- Increase the separation between the equipment and receiver.
- Connect the equipment into an circuit different from that to which the receiver is connected.
- Consult the dealer or an experienced radio TV technician for help.

Troubleshooting

There is no Power

- 1 The AC plugged is not well connected.
- 2 Check to see that the ON/OFF volume knob is in the on position.

There is no Sound

- 1 Check the volume level by turning the volume knob.

Turntable will not work

- 1 Make sure the function switch is set to phono.
- 2 Try moving the tone arm to the right until you hear a click.
- 3 Make sure the protective needle cover is removed.

CD does not play

- 1 Check to make sure CD is inserted correctly (label side facing up).
- 2 Check that the surface of the CD is clean
- 3 Make sure function switch is set to CD.

CD Operation

Repeat Playback

- 1 To repeat a single track, choose the track that you want to repeat, then press the PLAY BUTTON (16) to start the track. Press the REPEAT BUTTON (10) once to repeat this track. The REPEAT INDICATOR (9) will flash.
- 2 To repeat all tracks, press the PLAY BUTTON (16) to start the CD. Press the REPEAT BUTTON (10) twice to repeat all tracks. Once the CD ends, it will start over again from the beginning of the CD. The REPEAT INDICATOR (9) will remain on.
- 3 To erase the repeat function, press the REPEAT BUTTON (10) again until the REPEAT INDICATOR (9) is off.

Programmed Playback

- 1 Press the PROGRAM BUTTON (8). "01" will shown on the display and the PROGRAM INDICATOR (7) will flash.
- 2 Press the FORWARD SKIP BUTTON (13) or the BACKWARD SKIP BUTTON (11) to select a track.
- 3 Press the PROGRAM BUTTON (8) again to store the selected track number.
- 4 Repeat steps 2 and 3 above to program other tracks.
- 5 Press the PLAY BUTTON (16) to start Programmed playback. The PROGRAM INDICATOR (7) will be on.
- 6 To erase the programmed sequence, press the STOP BUTTON (14) twice or until the PROGRAM INDICATOR (7) is off. Programmed tracks will also erase when the CD DOOR (17) is opened.

NOTE: Maximum of 20 tracks can be programmed to play in any order.

Welcome

Thank you for purchasing the Crosley Rochester (CR66). Before operating this unit, please read this manual thoroughly and retain it for future reference.

About This Manual

Instructions in this manual describe the control functions of the CR66.

Table of Contents

Getting Started

Control Locators.....	4,5
Unpacking.....	6
Power Source.....	6

Base Operation

Turntable Operation.....	7
Accessory: Adapter for 45 rpm	7
Cassette Operation.....	8
Radio Operation.....	8

CD Operation

Playing a CD.....	9,10
Programmed Playback.....	10

General

Troubleshooting Guide.....	11
Warranty.....	12

Control Locators

Unit Controls

1. SPEAKER
2. FUNCTION SWITCH
3. TUNING KNOB
4. DIAL SCALE
5. ON/OFF-VOLUME ROTARY KNOB
6. AM/FM BAND SWITCH
7. PROGRAM INDICATOR
8. PROGRAM BUTTON
9. REPEAT INDICATOR
10. REPEAT BUTTON
11. B.SKIP BUTTON
12. LED DISPLAY
13. F.SKIP BUTTON
14. STOP BUTTON
15. PLAY INDICATOR
16. PLAY/PAUSE BUTTON
17. CD DOOR
18. OPEN/CLOSE BUTTON

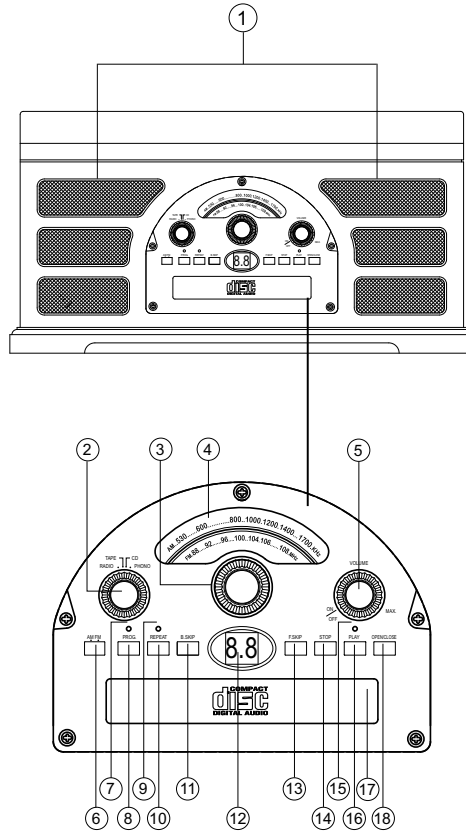

CD Operation

Playing A CD

- 1 Rotate the FUNCTION SWITCH (2) to CD.
- 2 Press the OPEN/CLOSE BUTTON (18) to open the CD DOOR (17). Place a disc in the tray with the labeled side of the disc facing up.
- 3 Press the OPEN/CLOSE BUTTON (18) again close the CD DOOR (17). The display will show "—" for a few seconds, then the total number of tracks on the disc will be displayed. "00" will be shown when there is no disc inside the unit.
- 4 Press the PLAY BUTTON (16) to start playback. The PLAY INDICATOR (15) will light up.
- 5 Adjust the VOLUME ROTARY KNOB (2) to the desired volume level.
- 6 To pause playback, press the PLAY/PAUSE BUTTON (16). The PLAY INDICATOR (15) will flash. Press the PLAY BUTTON (16) again to resume playback.
- 7 To stop playback, press the STOP BUTTON (14). The PLAY INDICATOR (15) will go off.

Skip Forward And Skip Reverse

- 1 Press the FORWARD SKIP BUTTON (13) or the BACKWARD SKIP BUTTON (11) to select a track.
- 2 Press the PLAY BUTTON (16) to start playing the selected track

Search Forward And Reverse During Play

PLAYBACK

- 1 Press and hold the FORWARD SKIP BUTTON (13) or the BACKWARD SKIP BUTTON (11) to search forward or backward through the selected track.
- 2 Release the button at the desired point, playback will resume automatically.

Cassette & Radio Operation

Cassette Operation

- 1 Rotate the FUNCTION SWITCH (2) to TAPE position.
- 2 Insert a prerecorded tape through the CASSETTE DOOR (29). Tape will slide into the cassette mechanism and start playing.
- 3 Adjust the volume level by turning the VOLUME KNOB (5).
- 4 For fast forwarding, press the CASSETTE EJECT/F.F (28) half way in. Pressing again, will stop the fast forwarding and return the cassette to the playing mode.
- 5 To stop and eject the cassette, press the CASSETTE EJECT/F.F (28) in completely.
- 6 When one side of the tape finishes playing, the cassette will automatically stop.

NOTE: Remove the tape from the unit when it is not in use or stopped.

Radio Operation

- 1 Rotate the FUNCTION SWITCH (2) to select RADIO mode.
- 2 Set the AM/FM BAND SWITCH (6) to the desired band (AM or FM).
- 3 Select the desired radio station by rotating TUNING KNOB (3)
- 4 Adjust the ON/OFF-VOLUME ROTARY KNOB (5) to the desired sound level.

Antenna

Antenna: for FM reception, the unit is provided with a FM WIRE ANTENNA (26), move the wire until the reception is clear and with no interferences. For AM reception, the unit is provided with a directional build-in ferrite antenna. Rotate the set to find the position in which the best reception is obtained. Do not connect the EXTERNAL FM ANTENNA (26) to any outside antenna.

Control Locators

Unit Controls

19. TURNTABLE
20. SPINDLE
21. ADAPTER FOR 45 RPM RECORD
22. TONE ARM
23. SPEED CONTROL SWITCH (33 $\frac{1}{3}$, 45, 78 RPM)
24. TONE ARM REST
25. SECURITY HOOK
26. EXTERNAL ANTENNA
27. AC POWER PLUG CORD
28. CASSETTE EJECT / FAST FORWARD
29. CASSETTE DOOR

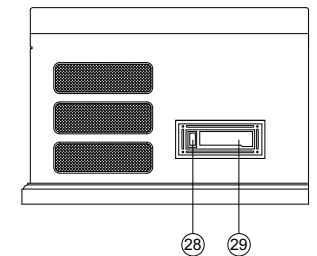
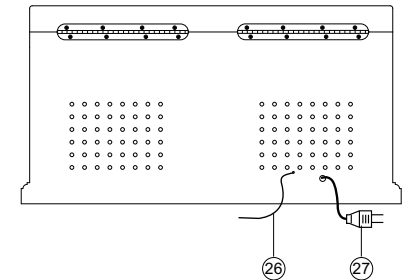
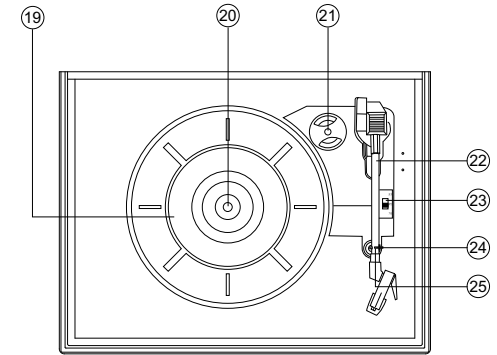

Getting Started

Unpacking

- 1 Remove packing materials from unit.
Note: Save all packing materials.
- 2 Remove plastic bag covering radio.
- 3 Remove plastic safety cover from A/C plug.
- 4 Remove tie from A/C cord and untie antenna wire on back of radio.
- 5 Open lid and remove styrofoam shipping material from turntable.
- 6 Remove black tie-wrap from under the tone arm.
- 7 Remove white protective needle cover by gently pulling towards the front of the unit.

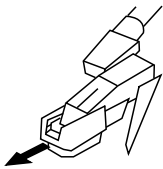

- 8 Untie the FM antenna and allow it to hang down in a straight line for optimum FM reception. If you have trouble tuning in an FM station, move the external FM antenna for best reception. Do not connect FM antenna to outside antenna.

Power Source

- 1 Unwind the AC POWER CORD (27) at the back of the unit and connect it to a power outlet.
- 2 Plug A/C cord into appropriate outlet.

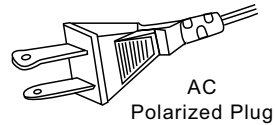

- 3 This product is equipped with a polarized alternating current line plug (a plug having one blade wider than the other). This plug will fit into the power outlet only one way. This is a safety feature. If you are unable to insert the plug fully into the outlet, try reversing the plug. If the plug should still fail to fit, contact your electrician to replace your obsolete outlet. Do not defeat the purpose of the polarized plug.

Turntable Operation

Turntable Operation

Turn the unit on by rotating the ON/OFF-VOLUME ROTARY KNOB (5) located on the front panel to the ON position.

- 1 Rotate the FUNCTION SWITCH (2) to select PHONO mode.
- 2 Set the SPEED CONTROL SWITCH (23) to desired speed (33 1/3, 45 or 78 rpm). Place the record on the turntable.
- 3 Pull the TONE ARM (22) slightly to the right side until you hear the "click" sound to activate the turntable.
- 4 Move the TONE ARM (22) by hand over the record and slowly lower it. Adjust the ON/OFF-VOLUME ROTARY KNOB (5) to the desired listening level.
- 5 At the end of the record, the TONE ARM (22) will stop automatically. You must return to TONE ARM to arm rest by hand.

Accessory: ADAPTER FOR 45 RPM

This adaptor allows you to play 45 RPM records.

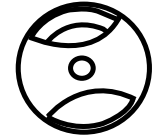

- 1 Place the 45 RPM adaptor over the spindle.
- 2 Gently place your 45 RPM record onto the turntable.
- 3 Follow the steps under turntable operation to play your record.

Free Manuals Download Website

<http://myh66.com>

<http://usermanuals.us>

<http://www.somanuals.com>

<http://www.4manuals.cc>

<http://www.manual-lib.com>

<http://www.404manual.com>

<http://www.luxmanual.com>

<http://aubethermostatmanual.com>

Golf course search by state

<http://golfingnear.com>

Email search by domain

<http://emailbydomain.com>

Auto manuals search

<http://auto.somanuals.com>

TV manuals search

<http://tv.somanuals.com>