





WARNING:

TO PREVENT FIRE OR SHOCK HAZARD, DO NOT EXPOSE THIS APPLIANCE TO RAIN OR MOISTURE. DO NOT REMOVE COVER. PILOT LAMPS SOLDERED IN PLACE. NO USER SERVICEABLE PARTS INSIDE. REFER SERVICING TO QUALIFIED SERVICE PERSONNEL.

	CAUTION RISK OF ELECTRIC SHOCK DO NOT OPEN	
CAUTION: TO REDUCE THE RISK OF ELECTRIC SHOCK, DO NOT REMOVE COVER (OR BACK). NO USER - SERVICEABLE PARTS INSIDE. REFER SERVICING TO QUALIFIED SERVICE PERSONNEL.		
	The lightning flash with arrowhead symbol, within an equilateral triangle, is intended to alert user to the presence of uninsulated "dangerous voltage" within the product's enclosure that may be of sufficient magnitude to constitute risk of electric shock to persons.	
	The exclamation point within an equilateral triangle is intended to alert user to the presence of important operating and maintenance (servicing) instruction in the literature accompanying the appliance.	

SPECIFICATION

FREQUENCY RANGE	:FM 87.5 - 108.5 MHz :AM 525 - 1710 KHz
POWER CONSUMPTION	:12W
POWER SOURCE	:AC adapter -(DC 12V 0.5A) (Included)
ANTENNAS	:Built-in antenna for FM :Built-in ferrite bar for AM
THREE SPEED	: 33 1/3, 45, 78 RPM

•DESIGN AND SPECIFICATION SUBJECT TO CHANGE WITHOUT NOTICE.



910-210300-002

CROSLEY®

3 SPEED TURNTABLE W/ RADIO



Model: CR-50TW

INSTRUCTION MANUAL

IMPORTANT SAFETY INSTRUCTION

PLEASE READ CAREFULLY ALL THE FOLLOWING IMPORTANT SAFEGUARDS THAT ARE APPLICABLE TO YOUR EQUIPMENT

1. Read Instructions - All the safety and operating instructions should be read before the product is operated.
2. Retain instructions - The safety and operating instructions should be retained for future reference.
3. Heed Warnings - All warnings on the product and in the operating Instructions should be adhered to.
4. Follow Instructions - All operating and use instructions should be followed.
5. Cleaning - Unplug this product from the wall outlet before cleaning. Do not use liquid cleaners or aerosol cleaners. Use a damp cloth for cleaning.
6. Attachments - Do not use attachments not recommended by the product manufacturer as they may cause hazards.
7. Water and Moisture - Do not use this product near water - for example, near a bath tub, wash bowl, kitchen sink, or laundry tub; in a wet basement; or near a swimming pool; and the like.
8. A product and cart combination should be moved with care. Quick stops, excessive force, and uneven surfaces may cause the product and cart combination to overturn.
9. Ventilation - Slots and openings in the cabinet are provided for ventilation and to ensure reliable operation of the product and to protect it from overheating, and these openings must not be blocked or covered. The openings should never be blocked by placing the product on a bed, sofa, rug, or other similar surface. This product should not be placed in a built - in installation such as a bookcase or rack unless proper ventilation is provided or the manufacturer's instructions have been adhered to.
10. Power Sources - This product should be operated only from the type of power source indicated on the marking label, if you are not sure of the type of power supply to your home. Consult your product dealer or local power company. For products intended to operate from battery power, or other sources, refer to the operating instructions.
11. Grounding or Polarization - This product may be equipped with a polarized alternating-current line plug (a plug having one blade wider than the other). This plug will fit into the power outlet only one way. This is a safety feature. If you are unable to insert the plug fully into the outlet try reversing the plug. If the plug should still fail to fit, contact your electrician to replace your obsolete outlet. Do not defeat the safety purpose of the polarized plug.
12. Power - Cord Protection - Power - supply cords should be routed so that they are not likely to be walked on or pinched by items placed upon or against them, paying particular attention to cords at plugs, convenience receptacles, and the point where they exit from the product.
13. Lightning - For added protection for this product during a lightning storm, or when it is left unattended and unused for long periods of time, unplug it from the wall outlet and disconnect the antenna or cable system. This will prevent damage to the product due to lightning and power - line surges.

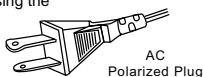

14. Power Lines - An outside antenna system should not be located in the vicinity of overhead power lines or other electric light or power circuits, or where it can fall into such power lines or circuits. When installing an outside antenna system, extreme care should be taken to keep from touching such power lines or circuits as contact with them might be fatal.
15. Overloading - Do not overload wall outlets, extension cords, or integral convenience receptacles as this can result in a risk of fire or electric shock.
16. Object and Liquid Entry - Never push objects of any kind into this product through openings as they may touch dangerous voltage points or short - out parts that could result in a fire or electric shock. Never spill liquid of any kind on the product.
17. Servicing - Do not attempt to service this product yourself as opening or removing covers may expose you to dangerous voltage or other hazards. Refer all servicing to qualified service personnel.
18. Damage Requiring Service - Unplug this product from the wall outlet and refer servicing to qualified service personnel under the following conditions:
 - a. When the power-supply cord or plug is damaged.
 - b. If liquid has been spilled, or objects have fallen into the product.
 - c. If the product has been exposed to rain or water.
 - d. If the product does not operate normally by following the operating instructions. Adjust only those controls that are covered by the operating instructions as an improper adjustment of other controls may result in damage and will often require extensive work by a qualified technician to restore the product to its normal operation.
 - e. If the product has been dropped or damaged in any way.
 - f. When the product exhibits a distinct change in performance - this indicates a need for service.
19. Replacement Parts - When replacement parts are required, be sure the service technician has used replacement parts specified by the manufacturer or have the same characteristics as the original part. Unauthorized substitutions may result in fire, electric shock, or other hazards.
20. Safety Check - Upon completion of any service or repairs to this product, ask the service technician to perform safety checks to determine that the product is in proper operating condition.
21. Wall or ceiling Mounting - The product should be mounted to a wall or ceiling only as recommended by the manufacturer.
22. Heat - The product should be situated away from heat sources such as radiators. Heat registers, stoves, or other products(including amplifiers) that produce heat.

WARNING: Changes or modifications to this unit not expressly approved by the party responsible for compliance could void the user's authority to operate the equipment.

NOTE: This equipment has been tested and found to comply with the limits for a Class B digital device, pursuant to Part 15 of the FCC Rules. These limits are designed to provide reasonable protection against harmful interference in a residential installation. This equipment generates, uses, and can radiate radio frequency energy and, if not installed and used in accordance with the instructions, may cause harmful interference to radio communications. However, there is no guarantee that interference will not occur in a particular installation. If this equipment does cause harmful interference to radio or television reception, which can be determined by turning the equipment off and on, the user is encouraged to try to correct the interference by one or more of the following measures:

- Reorient or relocate the receiving antenna.
- Increase the separation between the equipment and receiver.
- Connect the equipment into a circuit different from that to which the receiver is connected.
- Consult the dealer or an experienced radio TV technician for help.

POWER SOURCE

Connect the AC adapter between the unit and the power outlet.

UNPACKING THE TURNTABLE

1. Carefully remove unit from its package and take it out of the plastic bag.
2. Open lid and remove black tie-wrap by untwisting and gently sliding out from under tone arm.
3. Remove cardboard shipper.
4. Remove white protective needle cover by gently pulling towards front of unit.

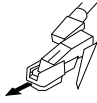

TURNTABLE OPERATION

Press the unit on by switching the POWER (10) located on the front panel to the ON position.

1. Press the PHONO (8) to set the PHONO mode.
2. Set the SPEED CONTROL SWITCH(5) to desire speed (33 1/3 ,45 or 78 rpm). Place the record on the turntable.
3. Adjust the Volume switch (10) set at the mid range.
4. Pull the TONE ARM (4) slightly to the right side until hear the "click" sound to activate the turntable.
5. Move the tone arm by hand out over the record and slowly lower it. Re adjust the VOLUME control (10) to the desire level.
6. At the end of the record, the tone arm will stop automatically by the center and return to the armrest manually.

ACCESSORY: ADAPTER FOR 45RPM

TO PLAY THE 45RPM RECORD, PLACE THE ADAPTER (3) ON THE SPINDLE(2).

RADIO OPERATION

1. Switch the unit ON by turning the POWER switch (10) to the ON position.
2. Place the VOLUME controls (10) in mid-range position.
3. Select the desired waveband by placing the BAND selector (8) in either the FM or AM position.
4. Select the desired station on the DIAL DISPLAY by rotating the TUNING KNOB (9). If you are tuning in an FM station, turn the AM/FM/AFC BAND SWITCH to the AFC position after you have tuned in the desired station, to lock it in.
5. Re-adjust the VOLUME controls (10) to suit your personal preference.
6. Switch the unit OFF by turning the POWER switch (10) to the OFF position.

TROUBLE SHOOTING GUIDE

The unit is not functioning

- * The AC power cord is not connected to a power outlet.
- * The unit is not turned on : rotate the VOLUME knob from the OFF position past the "click" to turn on the unit.

No radio

- * The function switch is not in the correct position. Turn function switch insert to RADIO.
- * Adjust the VOLUME knob.
- * Rotate the TUNING knob to find a radio station.

Needles are available for additional charges,
please call us at 1-800-926-7801 for assistance

www.crosleyradio.com

LOCATION OF PARTS

1. TURNTABLE
2. SPINDLE
3. ADAPTER FOR 45 RPM RECORDS
4. TONE ARM
5. SPEED CONTROL SWITCH
6. SPEAKER
7. ARM REST
8. AM/FM/PHONO (FUNCTION SWITCH)
9. TUNING KNOB
10. ON-OFF SWITCH / VOLUME CONTROL
11. DIAL SCALE
12. ADAPTER JACK
13. AC ADAPTER

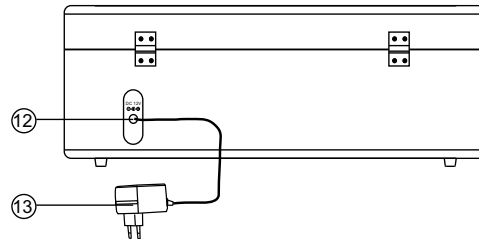
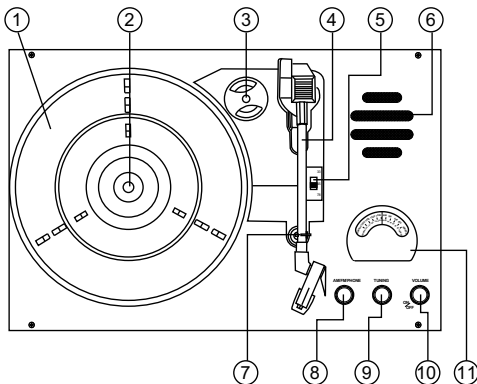

Free Manuals Download Website

<http://myh66.com>

<http://usermanuals.us>

<http://www.somanuals.com>

<http://www.4manuals.cc>

<http://www.manual-lib.com>

<http://www.404manual.com>

<http://www.luxmanual.com>

<http://aubethermostatmanual.com>

Golf course search by state

<http://golfingnear.com>

Email search by domain

<http://emailbydomain.com>

Auto manuals search

<http://auto.somanuals.com>

TV manuals search

<http://tv.somanuals.com>