

# CM-31 CM-31W

## MINIATURE CONDENSER HANGING MICROPHONE



The Crown® CM-31 is a professional-quality, supercardioid condenser microphone designed for inconspicuous miking of a choir, orchestra or stage. It can also hang over conference tables or discussion groups for inconspicuous isolated miking.

The CM-31 consists of two parts: the microphone with a permanently attached 30-foot (9.15-m) cable and the cylindrical electronics power module.

The mic cable connects to the power module, which adapts the microphone for phantom powering and includes a low-cut switch. Cable connection is via miniature 3-pin connectors. The power module output is balanced, low impedance. It is protected against static and radio-frequency interference.

The CM-31 has a smooth, wide-range frequency response for natural reproduction of the singing voice, organ or other musical instruments. Extreme low frequencies are filtered out to reduce pickup of room rumble.

The microphone has a built-in removable hanger which allows easy position adjustment. The CM-31 microphone and cable are black; the CM-31W microphone and cable are white.

### Operating Instructions

The power module supplied has been matched to the microphone. For best performance do not intermix microphones and modules.

Plug the microphone into the electronics power module. Run a 2-conductor shielded mic cable (not supplied) from your mixer to the power module, and plug it in.

Experiment with microphone placement before permanently installing the power module. A suggested placement for choir sound reinforcement is shown in Figs. 4a and 4b. For recording or broadcast, you might want to place the microphone a few feet farther away to pick up more room acoustics. Bend the wire hanger to achieve the desired pickup angle.

If rumble from trucks or air-conditioning is excessive, switch in the low-cut filter on the power module. The low-cut position (⎓) is toward the microphone.

After finding the desired microphone position, install the power module in one of three ways:

- Install the power module in the ceiling (Fig. 6).
- Pull up the mic cable until the mic is at the desired height, then knot the cable.
- Clamp the power module to a beam overhead (Fig. 7).
- Tape the power module to the floor.

### Features

- Ideal for picking up choirs
- Supercardioid polar pattern aids gain-before-feedback and rejects background noise
- Small and inconspicuous
- Hanger allows position adjustment
- XLR connector with built-in electronics

### Specifications

**Type:** Unidirectional condenser.

**Transducer:** Electret condenser.

**Frequency Response (typical):** 40 Hz to 20,000 Hz (see Fig. 1).

**Polar Pattern:** Supercardioid (see Fig. 2).

**Impedance:** 150 ohms, balanced. Recommended minimum load impedance 1000 ohms.

**Open Circuit Sensitivity:** 10 mV/Pa\* (-40 dB re 1 volt/Pa).

**Power Sensitivity:** -37.5 dB re 1 mW/Pa.

**Equivalent Noise Level:** 28 dB SPL typical (0 dB = .0002 dyne/cm<sup>2</sup>), A-weighted.

**S/N Ratio:** 66 dB at 94 dB SPL.

**Maximum Sound Pressure Level:** 120 dB SPL produces 3% THD.

**Mic-Cable Connector:** TA3F (mini XLR-type).

**Power Module Connector (input):** TB3M (mini XLR-type). See Fig. 3.

**Power Module Connector (output):** 3-pin male XLR-type.

**Power Module Switch:** Flat/low-cut.

**Operating Voltage:** Phantom power, 12 to 48 volts DC, positive voltage on pins 2 and 3 with respect to pin 1 of output connector.

**Materials:** Brass housing, steel power module housing.

**Finish:** Black (CM-31) or white (CM-31W).

**Weight (microphone and cable):** 4 ounces (113 grams).

**Weight (microphone, cable and power module):** 9.5 ounces (269 grams).

**Cable:** Black (CM-31) or white (CM-31W), 30' (9.15-m) 2-conductor shielded 0.1" (.254-cm) diameter cable from microphone to electronics; none supplied for electronics output. Use 2-conductor shielded microphone cable.

**Dimensions:** See Fig. 5 on reverse side.

**Included Accessories:** WS5 black foam windscreen for CM-31, WS5W white foam windscreen for CM-31W.

**Optional Accessories:** Crown PH-1A phantom power supply (1 channel, battery or AC adaptor powered).

\*1 pascal = 10 dynes/cm<sup>2</sup> = 10 microbars = 94 dB SPL.

Fig. 1

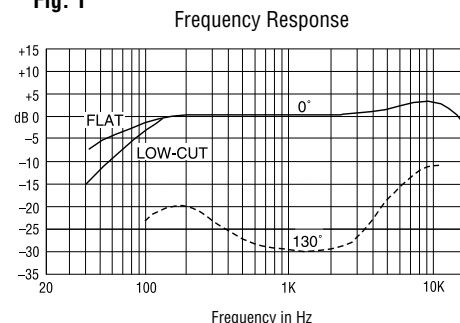

Fig. 2

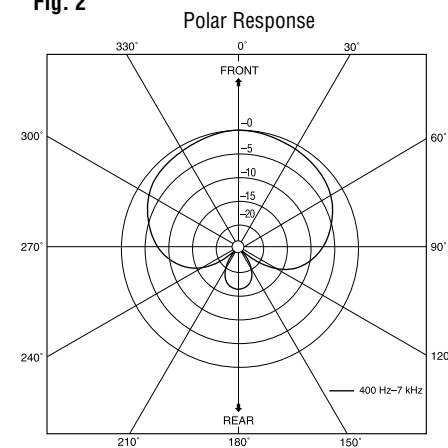
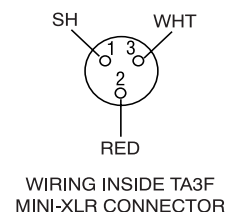

Fig. 3





INSTALLED

# CM-31 CM-31W

### Architects' and Engineers' Specifications

The microphone shall be the Crown CM-31. It shall be a professional-quality supercardioid condenser microphone designed for inconspicuous miking of a choir or other large musical ensembles. It can be hung from the ceiling, where its cable shall connect to a cylindrical electronics power module that adapts the microphone for phantom powering.

Frequency response shall be 40 Hz to 20,000 Hz. Extreme low frequencies shall be filtered out to reduce pickup of room rumble. The power module shall have flat/low-cut switch. Open-circuit sensitivity shall be 10 mV/Pa. Equivalent noise level shall be 28 dBA SPL typical; SPL

for 3% THD shall be 120 dB. The microphone output shall be balanced, low impedance, with RFI and static protection.

A built-in removable hanger shall allow position adjustment. The mic-cable connector shall be a TA3F. The power module input connector shall be a TB3M and the power module output connector shall be a 3-pin male XLR-type. Operating voltage shall be standard phantom power, 12 to 48 volts DC, positive voltage on pins 2 and 3 with respect to pin 1 of output connector. Finish shall be black (CM-31) or white (CM-31W). The cable from mic to electronics shall be 30-foot (9.15-m) 2-conductor shielded. The Crown CM-31 is specified.

### Warranty

Crown professional microphones are guaranteed unconditionally against malfunction from any cause for a period of three years from date of original purchase. See enclosed warranty sheet for additional information.

### Service

If the microphone does not function properly, replace or repair mic cables and connectors, check the power supply.

If you determine the microphone product(s) is defective, return the complete product (mic and interface) in its original package to: **Crown Factory Service, 1718 W. Mishawaka Road, Elkhart, IN 46517-9439.** A Service Return Authorization (SRA) is required for product being sent to the factory for service. An SRA can be completed on line at [www.crownaudio.com/support/factserv.htm](http://www.crownaudio.com/support/factserv.htm). For further assistance or technical support call **800-342-6939.**

**The mic and electronics are a matched pair. Do not separate them. For service send them both in.**

Fig. 4a

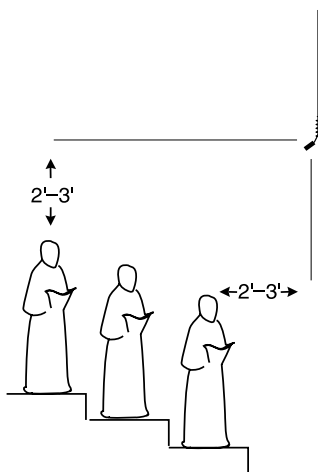

Fig. 6

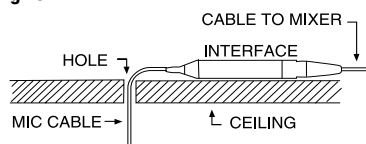

Fig. 7

Use the clamp and screw provided to mount the CM-31/CM-31W power module onto the ceiling, a wooden beam, or beneath a lectern/table.

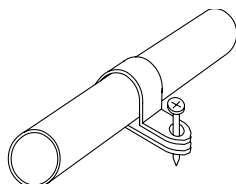

Fig. 4b

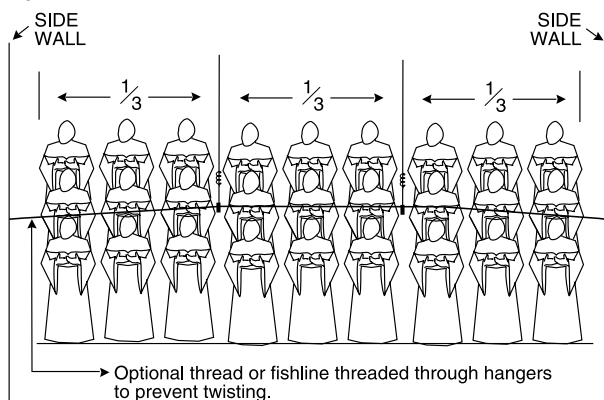
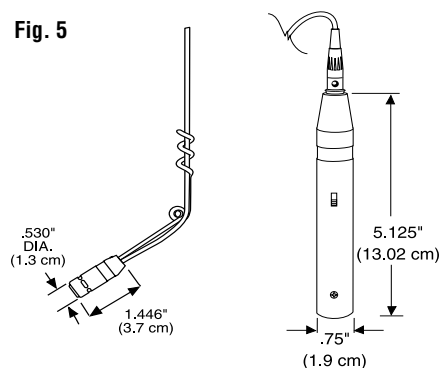

Fig. 5



H A Harman International Company

Crown International, Inc.  
1718 W. Mishawaka Rd.  
Elkhart, IN 46517-9439  
TEL: 574-294-8000  
FAX: 574-294-8FAX  
[www.crownaudio.com](http://www.crownaudio.com)

©2005 Crown Audio®, Inc.  
Specifications subject to change without prior notice.  
Crown and Crown Audio are registered trademarks of Crown International, Inc.

## Free Manuals Download Website

<http://myh66.com>

<http://usermanuals.us>

<http://www.somanuals.com>

<http://www.4manuals.cc>

<http://www.manual-lib.com>

<http://www.404manual.com>

<http://www.luxmanual.com>

<http://aubethermostatmanual.com>

Golf course search by state

<http://golfingnear.com>

Email search by domain

<http://emailbydomain.com>

Auto manuals search

<http://auto.somanuals.com>

TV manuals search

<http://tv.somanuals.com>