



# CTs Series Operation Manual

## Page 3: 2-channel models

CTs 600



CTs 1200



CTs 2000



CTs 3000



## Page 31: Multi-channel models

CTs 4200

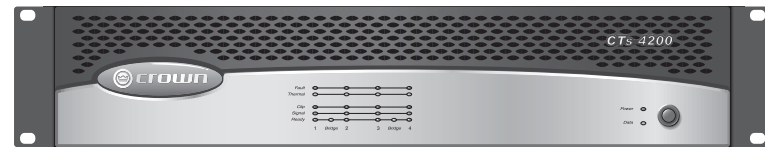

CTs 8200



**Obtaining Other Language Versions:** To obtain information in another language about the use of this product, please contact your local Crown Distributor. If you need assistance locating your local distributor, please contact Crown at 574-294-8000.

This manual does not include all of the details of design, production, or variations of the equipment. Nor does it cover every possible situation which may arise during installation, operation or maintenance.

The information provided in this manual was deemed accurate as of the publication date. However, updates to this information may have occurred. To obtain the latest version of this manual, please visit the Crown website at [www.crownaudio.com](http://www.crownaudio.com).

**Trademark Notice:** Com-Tech, BCA, Crown, Crown Audio, Amcron and Multi-Mode are registered trademarks of Crown International. IQwic, PIP and PIP2 are trademarks of Crown International. Other trademarks are the property of their respective owners.

## Important Safety Instructions

### Importantes Instrucciones de Seguridad

- 1) Read these instructions.
- 2) Keep these instructions.
- 3) Heed all warnings.
- 4) Follow all instructions.
- 5) Do not use this apparatus near water.
- 6) Clean only with a dry cloth.
- 7) Do not block any ventilation openings. Install in accordance with the manufacturer's instructions.
- 8) Do not install near any heat sources such as radiators, heat registers, stoves, or other apparatus (including amplifiers) that produce heat.
- 9) Do not defeat the safety purpose of the polarized or grounding-type plug. A polarized plug has two blades with one wider than the other. A grounding-type plug has two blades and a third grounding prong. The wide blade or the third prong is provided for your safety. If the provided plug does not fit into your outlet, consult an electrician for replacement of the obsolete outlet.
- 10) Protect the power cord from being walked on or pinched, particularly at plugs, convenience receptacles, and the point where they exit from the apparatus.
- 11) Only use attachments/accessories specified by the manufacturer.
- 12) Use only with a cart, stand, tripod, bracket, or table specified by the manufacturer, or sold with the apparatus. When a cart is used, use caution when moving the cart/apparatus combination to avoid injury from tip-over.
- 13) Unplug this apparatus during lightning storms or when unused for long periods of time.
- 14) Refer all servicing to qualified service personnel. Servicing is required when the apparatus has been damaged in any way, such as power-supply cord or plug is damaged, liquid has been spilled or objects have fallen into the apparatus, the apparatus has been exposed to rain or moisture, does not operate normally, or has been dropped.
- 15) Use the mains plug to disconnect the apparatus from the mains.
- 16) **WARNING: TO REDUCE THE RISK OF FIRE OR ELECTRIC SHOCK, DO NOT EXPOSE THIS APPARATUS TO RAIN OR MOISTURE.**
- 17) **DO NOT EXPOSE THIS EQUIPMENT TO DRIPPING OR SPLASHING AND ENSURE THAT NO OBJECTS FILLED WITH LIQUIDS, SUCH AS VASES, ARE PLACED ON THE EQUIPMENT.**
- 18) **THE MAINS PLUG OF THE POWER SUPPLY CORD SHALL REMAIN READILY OPERABLE.**



## Wichtige Sicherheitsinstruktionen

### Instrucciones de Seguridad Importantes

TO PREVENT ELECTRIC SHOCK DO NOT REMOVE TOP OR BOTTOM COVERS. NO USER SERVICEABLE PARTS INSIDE. REFER SERVICING TO QUALIFIED SERVICE PERSONNEL.

À PRÉVENIR LE CHOC ÉLECTRIQUE N'ENLEVEZ PAS LES COUVERCLES. IL N'Y A PAS DES PARTIES SERVICEABLE À L'INTÉRIEUR. TOUTS REPARATIONS DOIT ÊTRE FAIRE PAR PERSONNEL QUALIFIÉ SEULMENT.

PARA PREVENIR UN CHOQUE ELÉCTRICO, NO RETIRE LAS CUBIERTAS SUPERIOR O INFERIOR. NO EXISTEN PARTES QUE PUEDAN SER REPARADAS POR EL USUARIO AL INTERIOR. REMITA EL SERVICIO AL PERSONAL TÉCNICO CALIFICADO.

TO COMPLETELY DISCONNECT THIS EQUIPMENT FROM THE AC MAINS, DISCONNECT THE POWER SUPPLY CORD PLUG FROM THE AC RECEPTACLE. THE MAINS PLUG OF THE POWER SUPPLY CORD SHALL REMAIN READILY OPERABLE.

POUR DÉMONTÉ COMPLÈTEMENT L'ÉQUIPEMENT DE L'ALIMENTATION GÉNÉRALE, DÉMONTÉ LE CÂBLE D'ALIMENTATION DE SON RÉCEPTACLE. LA PRISE D'ALIMENTATION RESTERA AISÉMENT FONCTIONNELLE.

PARA DESCONECTAR COMPLETAMENTE EL EQUIPO DEL SUMINISTRO ELÉCTRICO, DESCONECTE EL CABLE DE ALIMENTACION DE LA TOMA DE CA. LAS PATAS DEL CONECTOR DEL CABLE DE ALIMENTACIÓN DEBERAN MANTENERSE EN BUEN ESTADO.

#### WATCH FOR THESE SYMBOLS:

The lightning bolt triangle is used to alert the user to the risk of electric shock.

The exclamation point triangle is used to alert the user to important operating or maintenance instructions.

#### REGARDEZ CES SYMBOLES

La triangle avec le sigle "foudre" est employée pour alerter l'utilisateur au risque de décharge électrique. Le triangle avec un point d'exclamation est employée pour alerter l'utilisateur d'instruction importantes pour lors opérations de maintenance.

#### ATENCION CON ESTOS SÍMBOLOS

El triángulo con el símbolo de rayo eléctrico es usado para alertar al usuario de el riesgo de un choque eléctrico.

El triángulo con el signo de admiración es usado para alertar al usuario de instrucciones importantes de operación o mantenimiento.



**CAUTION**  
RISK OF ELECTRIC SHOCK  
DO NOT OPEN



**AVIS**  
RISQUE DE CHOC ÉLECTRIQUE  
NE OUVREZ PAS



#### IMPORTANT

CTs Series amplifiers require Class 2 output wiring. Les amplificateurs de série de CTs exigent des câbles de sortie de classe 2. CTs-Reihe-Verstärker verlangen Klasse die 2 Produktionsverdrahtung. Los amplificadores de la Serie CTs requieren de un cableado de salida Clase 2.

#### MAGNETIC FIELD

**CAUTION!** Do not locate sensitive high-gain equipment such as preamplifiers directly above or below the unit. Because this amplifier has a high power density, it has a strong magnetic field which can induce hum into unshielded devices that are located nearby. The field is strongest just above and below the unit.

If an equipment rack is used, we recommend locating the amplifier(s) in the bottom of the rack and the preamplifier or other sensitive equipment at the top.

### FCC COMPLIANCE NOTICE

This device complies with part 15 of the FCC rules. Operation is subject to the following two conditions: (1) This device may not cause harmful interference, and (2) this device must accept any interference received, including interference that may cause undesired operation.

**CAUTION:** Changes or modifications not expressly approved by the party responsible for compliance could void the user's authority to operate the equipment.

**NOTE:** This equipment has been tested and found to comply with the limits for a Class B or Class A digital device (depending on the model), pursuant to part 15 of the FCC Rules. These limits are designed to provide reasonable protection against harmful interference in a residential installation. This equipment generates, uses, and can radiate radio frequency energy and, if not installed and used in accordance with the instruction manual, may cause harmful interference to radio communications. However, there is no guarantee that interference will not occur in a particular installation. If this equipment does cause harmful interference to radio or television reception, which can be determined by turning the equipment off and on, the user is encouraged to try to correct the interference by one or more of the following measures:

- Reorient or relocate the receiving antenna.
- Increase the separation between the equipment and receiver.
- Connect the equipment into an outlet on a circuit different from that to which the receiver is connected.
- Consult the dealer or an experienced radio/TV technician for help.

# CTs 2-Channel Series



**CTs 600**



**CTs 1200**



**CTs 2000**

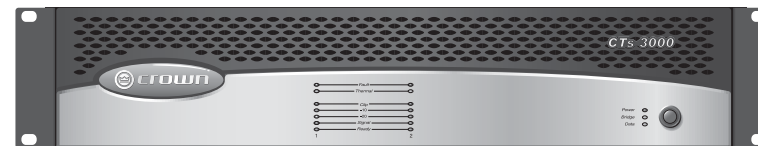

**CTs 3000**

THIS PAGE INTENTIONALLY LEFT BLANK

Crown Audio, Inc.

## DECLARATION of CONFORMITY

ISSUED BY: Crown Audio, Inc.  
1718 W. Mishawaka Road  
Elkhart, Indiana 46517 U.S.A.

FOR COMPLIANCE QUESTIONS ONLY: Sue Whitfield  
574-294-8289  
swhitfield@crowntl.com

**European Representative's Name and Address:**

David Budge  
10 Harvest Close  
Yateley GU46 6YS  
United Kingdom

**Equipment Type:** Commercial Audio Power Amplifiers

**Family Name:** CTs

**Model Names:** CTs 3000, CTs 2000, CTs 1200, CTs 600

**EMC Standards:**

**EN 55103-1:1997** Electromagnetic Compatibility - Product Family Standard for Audio, Video, Audio-Visual and Entertainment Lighting Control Apparatus for Professional Use, Part 1: Emissions

**EN 55103-1:1997** Magnetic Field Emissions-Annex A @ 10 cm and 1 M

**EN 61000-3-2:1995+A14:2000** Limits for Harmonic Current Emissions (equipment input current  $\leq 16$ A per phase)

**EN 61000-3-3:1995** Limitation of Voltage Fluctuations and Flicker in Low-Voltage Supply Systems Rated Current  $\leq 16$ A

**EN 55022:2003** Limits and Methods of Measurement of Radio Disturbance Characteristics of ITE: Radiated, Class B Limits; Conducted, Class B

**EN 55103-2:1997** Electromagnetic Compatibility - Product Family Standard for Audio, Video, Audio-Visual and Entertainment Lighting Control Apparatus for Professional Use, Part 2: Immunity

**EN 61000-4-2:2003** Electrostatic Discharge Immunity (Environment E2-Criteria B, 4k V Contact, 8k V Air Discharge)

**EN 61000-4-3:2003** Radiated, Radio-Frequency, Electromagnetic Immunity (Environment E2, criteria A)

**EN 61000-4-4:2005** Electrical Fast Transient/Burst Immunity (Criteria B)

**EN 61000-4-5:2001** Surge Immunity (Criteria B)

**EN 61000-4-6:1996** Immunity to Conducted Disturbances Induced by Radio-Frequency Fields (Criteria A)

**EN 61000-4-11:2004** Voltage Dips, Short Interruptions and Voltage Variation

**Safety Standard:**

**EN 60065: 1998** Safety Requirements - Audio Video and Similar Electronic Apparatus

I certify that the product identified above conforms to the requirements of the EMC Council Directive 89/336/EEC as amended by 92/31/EEC, and the Low Voltage Directive 73/23/EES as amended by 93/68/EEC.

Signed



Larry Coburn

Title: Senior Vice President of Manufacturing

Date of Issue: March 1, 2002

## Table of Contents

Important Safety Instructions .....	2	<b>5 Advanced Features and Options .....</b>	<b>18</b>
<b>CTs 2-Channel Models.....</b>	<b>3</b>	5.1 Protection Systems .....	18
Declaration of Conformity .....	5	5.1.1 Thermal Level Control (TLC) .....	18
<b>1 Welcome .....</b>	<b>8</b>	5.1.2 Junction Temperature Simulation (JTS).....	18
1.1 Features .....	8	5.1.3 Fault .....	18
<b>2 How to Use This Manual .....</b>	<b>9</b>	5.1.4 High-Pass Filters .....	18
<b>3 Setup .....</b>	<b>10</b>	5.1.5 Low-Pass Filters .....	18
3.1 Unpack Your Amplifier .....	10	5.1.6 AC Under/Over Voltage Protection .....	18
3.2 Install Your Amplifier .....	10	5.1.7 Circuit Breaker .....	18
3.3 Ensure Proper Cooling .....	10	5.1.8 DC Output Servo .....	18
3.4 Choose Input Wire and Connectors .....	11	5.1.9 Inrush Limiting .....	18
3.5 Choose Output Wire and Connectors .....	11	5.1.10 Variable-speed Fans .....	18
3.6 Wire Your System .....	12	5.2 Advanced Features .....	18
3.6.1 Dual 8/4/2 Mode .....	12	5.2.1 Switching Power Supply .....	18
3.6.2 Bridge-Mono 16/8/4 Mode .....	12	5.2.2 Input Compressor .....	18
3.6.3 Dual 70V/100V Mode .....	13	5.2.3 Sleep Circuit.....	18
3.6.4 Bridge-Mono 140V/200V Mode .....	13	5.2.4 Input Sensitivity Switches .....	19
3.6.5 Dual Mode with "Y" Input .....	14	5.3 Options .....	19
3.7 Connect to AC Mains .....	15	5.3.1 Nominal Attenuation Settings .....	20
3.8 Startup Procedure .....	15	<b>6 Troubleshooting .....</b>	<b>21</b>
<b>4 Operation .....</b>	<b>15</b>	<b>7 Specifications .....</b>	<b>23</b>
4.1 Precautions .....	15	<b>8 AC Power Draw and Thermal Dissipation.....</b>	<b>27</b>
4.2 Front Panel Controls and Indicators .....	16		
4.3 Back Panel Controls and Connectors .....	17		

(Continued on next page)

# Table of Contents

<b>CTs Multi-Channel Models</b> .....	<b>31</b>		
Declaration of Conformity .....	32		
<b>1 Welcome</b> .....	<b>33</b>		
1.1 Features .....	33		
<b>2 How to Use This Manual</b> .....	<b>33</b>		
<b>3 Setup</b> .....	<b>34</b>		
3.1 Unpack Your Amplifier .....	34		
3.2 Install Your Amplifier .....	34		
3.3 Ensure Proper Cooling .....	34		
3.4 Choose Input Wire and Connectors .....	35		
3.5 Choose Output Wire and Connectors .....	35		
3.6 Wire Your System .....	36		
3.6.1 Dual 8/4 Mode .....	36		
3.6.2 Dual 70V Mode .....	36		
3.6.3 Bridge-Mono 16/8 Mode .....	37		
3.6.4 Bridge-Mono 100V Mode .....	37		
3.7 Connect to AC Mains .....	38		
3.8 Startup Procedure .....	38		
<b>4 Operation</b> .....	<b>39</b>		
4.1 Precautions .....	39		
4.2 Front Panel Controls and Indicators .....	40		
4.3 Back Panel Controls and Connectors .....	41		
<b>5 Advanced Features and Options</b> .....	<b>42</b>		
5.1 Protection Systems .....	42		
5.1.1 Thermal Level Control (TLC) .....	42		
5.1.2 Fault .....	42		
5.1.3 Fault Isolation Topology (FIT) .....	42		
5.1.4 35-Hz High-Pass Filter .....	42		
5.1.5 AC Under-/Over-Voltage Protection .....	42		
5.1.6 Power Fuse .....	42		
5.1.7 Inrush Limiting .....	42		
5.1.8 Variable-speed Fans .....	42		
5.2 Advanced Features .....	42		
5.2.1 Switching Power Supply .....	42		
5.2.2 Mode Switch .....	42		
5.2.3 Bridge Mode Indicator .....	42		
5.2.4 Channel Level Control .....	43		
5.3 Options .....	44		
5.3.1 Control Modules .....	44		
5.3.2 Input Sensitivity .....	44		
<b>6 Troubleshooting</b> .....	<b>45</b>		
<b>7 Specifications</b> .....	<b>47</b>		
<b>8 AC Power Draw and Thermal Dissipation</b> .....	<b>51</b>		
<b>CTs 2-Channel and Multi-Channel Models</b>			
<b>9 Service</b> .....	<b>53</b>		
9.1. International and Canada Service .....	53		
9.2 US Service .....	53		
9.2.1 Service at a US Service Center .....	53		
9.2.2 Factory Service .....	53		
9.2.3 Factory Service Shipping Instructions.....	53		
9.2.4 Packing Instructions .....	53		
9.2.5 Estimate Approval .....	53		
9.2.6 Payment of Non-Warranty Repairs.....	53		
<b>10 Warranty</b> .....	<b>54</b>		
Factory Service Information Form .....	57		
Product Registration Form.....	59		

## CTs 600

 20 Hz–20 kHz  
Power

2-ohm Dual (per ch.)	<b>150W</b>
4-ohm Dual (per ch.)	<b>300W</b>
8-ohm Dual (per ch.)	<b>300W</b>
16-ohm Dual (per ch.)	<b>300W</b>
70V Dual (per ch.)	<b>300W</b>
100V Dual (per ch.)	<b>300W*</b>
4-ohm Bridge	<b>300W</b>
8-ohm Bridge	<b>600W</b>
16-ohm Bridge	<b>600W</b>
100V Bridge	<b>600W*</b>
140V Bridge	<b>600W</b>
200V Bridge	<b>600W*</b>

20 Hz–20 kHz Power refers to maximum average power in watts from 20 Hz to 20 kHz with 0.1% THD.

\*With T-170V or TP-170V.

## CTs 1200

 20 Hz–20 kHz  
Power

2-ohm Dual (per ch.)	<b>250W</b>
4-ohm Dual (per ch.)	<b>600W</b>
8-ohm Dual (per ch.)	<b>600W</b>
16-ohm Dual (per ch.)	<b>300W</b>
70V Dual (per ch.)	<b>600W</b>
100V Dual (per ch.)	<b>600W*</b>
4-ohm Bridge	<b>500W</b>
8-ohm Bridge	<b>1200W</b>
16-ohm Bridge	<b>1200W</b>
100V Bridge	<b>1200W*</b>
140V Bridge	<b>1200W</b>
200V Bridge	<b>1200W*</b>

20 Hz–20 kHz Power refers to maximum average power in watts from 20 Hz to 20 kHz with 0.1% THD.

\*With T-170V or TP-170V.



## 1 Welcome

Building on the foundation of the *Com-Tech*® Series, the Crown® *CTs* Series offers new flexibility and value for installed sound. The Com-Tech Series was the first to offer independent selection of high- and low-impedance operation for a specific channel, and CTs Series amplifiers continue that tradition, with power levels and features carefully chosen to perfectly integrate into fixed install design requirements.

Modern power amplifiers are sophisticated pieces of engineering capable of producing extremely high power levels. They must be treated with respect and correctly installed if they are to provide the many years of reliable service for which they were designed.

In addition, CTs Series amplifiers include a number of features which require some explanation before they can be used to their maximum advantage.

Please take the time to study this manual so that you can obtain the best possible service from your amplifier.

### 1.1 Features

- Switching Power Supply for reduced weight.
- High power-density, with all two-channel models in a 2U chassis.

- Direct constant-voltage (70V/140V) or low-impedance (2/4/8 ohm) operation. No switch required.
- Input sensitivity is independently selectable for each channel. Choose low-impedance (4/8 ohm), constant-voltage (70V/100V/140V/200V), or 26 dB.
- TLC protection circuitry protects the amplifier from long-term excessive heat by subtly and dynamically reducing the gain only when necessary.
- JTS circuitry (CTs 600/1200 only) quickly protects BJT output transistors from unsafe operating conditions without shutting the channel down. (Not applicable to BCA amplifiers as they are inherently protected.)
- PIP2™ (Programmable Input Processor) connector accepts accessory modules that tailor the amplifier to suit specific applications.
- Removable terminal block input connectors, with "Y" Input Switch in the standard PIP2-BBY module.

(Continued on next page)

## CTs 2000

 20 Hz–20 kHz  
Power

2-ohm Dual (per ch.)	<b>1000W</b>
4-ohm Dual (per ch.)	<b>1000W</b>
8-ohm Dual (per ch.)	<b>1000W</b>
16-ohm Dual (per ch.)	<b>625W</b>
70V Dual (per ch.)	<b>1000W</b>
100V Dual (per ch.)	<b>1000W</b>
4-ohm Bridge	<b>2000W</b>
8-ohm Bridge	<b>2000W</b>
16-ohm Bridge	<b>2000W</b>
140V Bridge	<b>2000W</b>
200V Bridge	<b>2000W</b>

20 Hz–20 kHz Power refers to maximum average power in watts from 20 Hz to 20 kHz with 0.35% THD.

## CTs 3000

 20 Hz–20 kHz  
Power

2-ohm Dual (per ch.)	<b>1500W</b>
4-ohm Dual (per ch.)	<b>1500W</b>
8-ohm Dual (per ch.)	<b>1250W</b>
16-ohm Dual (per ch.)	<b>625W</b>
70V Dual (per ch.)	<b>1500W</b>
100V Dual (per ch.)	<b>1500W</b>
4-ohm Bridge	<b>3000W</b>
8-ohm Bridge	<b>3000W</b>
16-ohm Bridge	<b>2500W</b>
140V Bridge	<b>3000W</b>
200V Bridge	<b>3000W</b>

20 Hz–20 kHz Power refers to maximum average power in watts from 20 Hz to 20 kHz with 0.35% THD.



## 1 Welcome

### Features (continued from page 8)

- Switchable high-pass filter for each channel provides low-frequency roll off to eliminate step down transformer saturation when used in distributed systems.
  - Comprehensive array of indicators including Power, Data, and Bridge; along with Ready, Signal, Clip, Thermal and Fault for each channel, provide accurate diagnostics.
  - Blue Power Indicator flashes if the amplifier shuts off due to an under/over-voltage condition on the AC mains.
  - Advanced protection circuitry guards against: shorted outputs, DC, mismatched loads, general overheating, under-/over-voltage, high-frequency overloads and internal faults.
- Legendary Crown class I (BCA<sup>®</sup>) and class AB+B (Multi-Mode<sup>®</sup>) output topologies offer the best in amplifier reliability. CTs 600/1200 use Class AB+B; CTs 2000/3000 use Class I.
  - Class I is the lowest distortion, lowest noise, and highest performing topology available among switch-mode amplifiers.
  - Continuously-variable fans optimize cooling efficiency.
  - Three Year, No-Fault, Fully-Transferable Warranty completely protects your investment and guarantees its specifications.

## 2 How to Use This Manual

This manual provides you with the necessary information to safely and correctly setup and operate your amplifier. It does not cover every aspect of installation, setup or operation that might occur under every condition. For additional information, please consult Crown's *Amplifier Application Guide* (available online at [www.crownaudio.com](http://www.crownaudio.com)), Crown Tech Support, your system installer or retailer.

We strongly recommend you read all instructions, warnings and cautions contained in this manual. Also, for your protection, please send in your warranty registration card today. And save your bill of sale—it's your official proof of purchase.

### 3 Setup

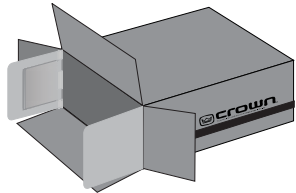

#### 3.1 Unpack Your Amplifier

Please unpack and inspect your amplifier for any damage that may have occurred during transit. If damage is found, notify the transportation company immediately. Only you can initiate a claim for shipping damage. Crown will be happy to help as needed. Save the shipping carton as evidence of damage for the shipper's inspection.

We also recommend that you save all packing materials so you will have them if you ever need to transport the unit. **Never ship the unit without the factory pack.**

YOU WILL NEED (not supplied):

- Input wiring cables
- Output wiring cables
- Phillips screwdriver

Rack for mounting amplifier (or a stable surface for stacking)



**WARNING:** Before you start to set up your amplifier, make sure you read and observe the Important Safety Instructions found at the beginning of this manual.

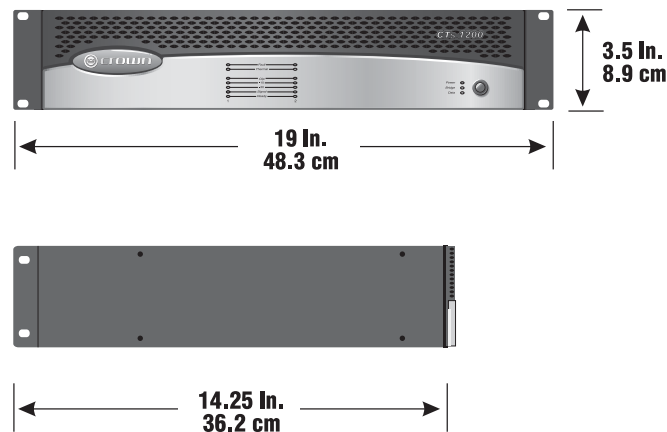

Figure 3.1 CTs 2-Channel Series Dimensions

#### 3.2 Install Your Amplifier



**CAUTION:** Before you begin, make sure your amplifier is disconnected from the power source, with power switch in the "off" position and all level controls turned completely down (counterclockwise).

Use a standard 19-inch (48.3 cm) equipment rack. See Figure 3.1 for amplifier dimensions.

You may also stack amps without using a cabinet.

NOTE: When transporting, amplifiers should be supported at both front and back.

#### 3.3 Ensure Proper Cooling

When using an equipment rack, mount units directly on top of each other. Close any open spaces in rack with blank panels. DO NOT block front or rear air vents. The side walls of the rack should be a minimum of two inches (5.1 cm) away from the amplifier sides, and the back of the rack should be a minimum of four inches (10.2 cm) from the amplifier back panel.

Figure 3.2 illustrates standard amplifier airflow.

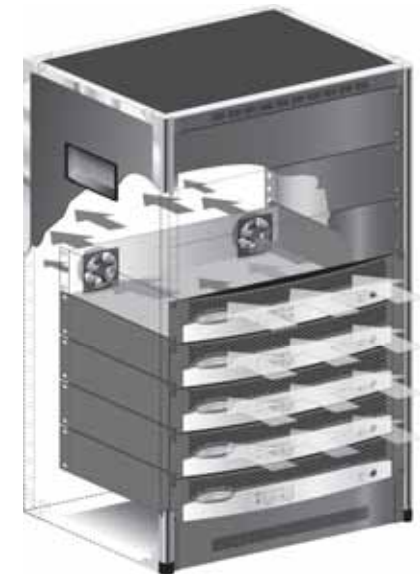

Figure 3.2 Airflow

### 3 Setup

#### 3.4 Choose Input Wire and Connectors

Figure 3.3 shows connector pin assignments for balanced wiring, and Figure 3.4 shows connector pin assignments for unbalanced wiring.



**NOTE: Custom wiring should only be performed by qualified personnel.**

#### 3.5 Choose Output Wire and Connectors

A protective cover is installed over the barrier-strip output. Some models have a cover with two holes. To remove this type of cover:

1. Loosen screws inside top and bottom holes of cover (see Figure 3.6).
2. Slide cover to left or right, then pull it off away from the amplifier.
3. Tighten screws.

Crown recommends using professionally constructed, high-quality, two- or four-conductor, heavy gauge speaker wire and connectors. You may use terminal forks up to 10 AWG or bare wire for your output connectors (see Figure 3.5). To prevent the possibility of short-circuits, wrap or otherwise insulate exposed loudspeaker cable connectors. For best results, Crown recommends Panduit part #PV10-10LF-L or equivalent terminal fork. Screw spacing is shown in Figure 3.5.

Using the guidelines below, select the appropriate size of wire based on the distance from amplifier to speaker (low-impedance loads only).

Distance	Wire Size
up to 25 ft. (7.6m)	16 AWG
26-40 ft. (7.9-12.2m)	14 AWG
41-60 ft. (12.5-18.3m)	12 AWG
> 60 ft (18.3m)	10 AWG



**CAUTION: Never use shielded cable for output wiring.**



**Replace output cover after output wiring is complete.**

#### BALANCED LINE

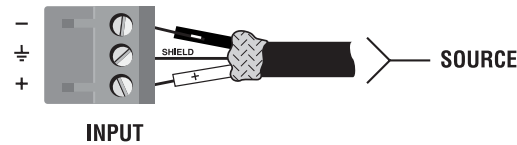

Figure 3.3  
Balanced Input  
Connector Wiring

#### UNBALANCED LINE

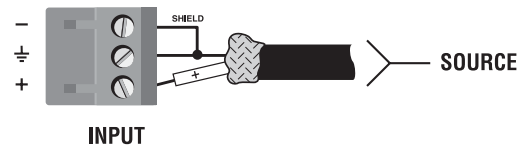

Figure 3.4  
Unbalanced Input  
Connector Wiring

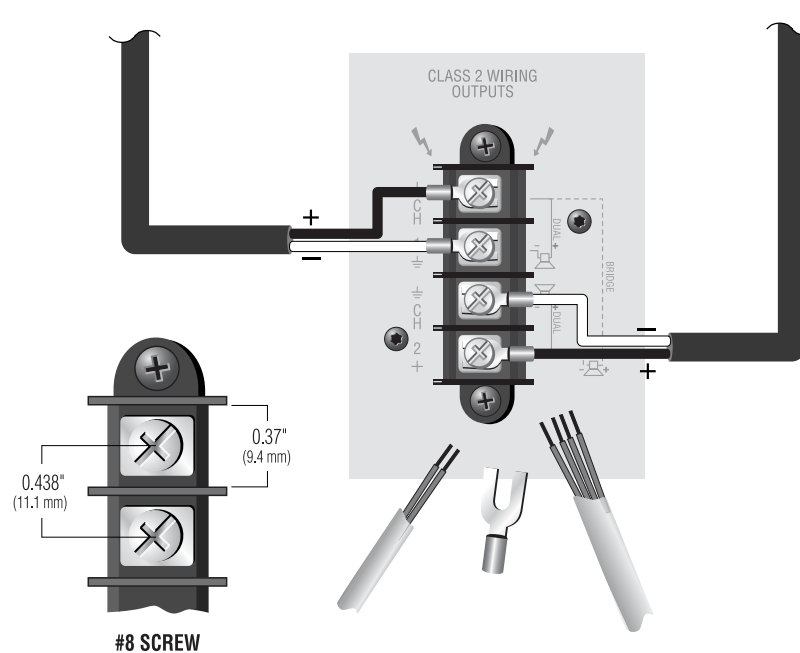

Figure 3.5 Typical Output Connector Wiring

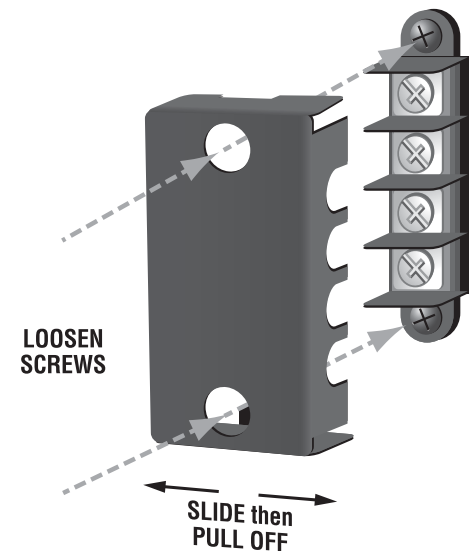

Figure 3.6 How to Remove the Two-Holed  
Barrier-Block Cover

### 3 Setup

#### 3.6 Wire Your System

##### 3.6.1 Dual 8/4/2 Mode

Typical input and output wiring, along with Attenuator and Mode Switch settings are shown in Figures 3.6 and 3.7. Make sure the Mode switch is set to the "Dual" position when operating in Dual mode.

**INPUTS:** Connect input wiring for each channel. The Y switch on the rear PIP panel can be used to parallel the channel inputs when only mono input signals are necessary. The amplifier's channel outputs are still independent.

**OUTPUTS:** Maintain proper polarity (+/-) on output connectors.

Connect the Channel 1 speaker's positive (+) lead to amplifier Channel 1 positive terminal; repeat for negative (-). Repeat Channel-2 wiring as for Channel 1. Refer to Section 3.5 for output connector pin assignments.

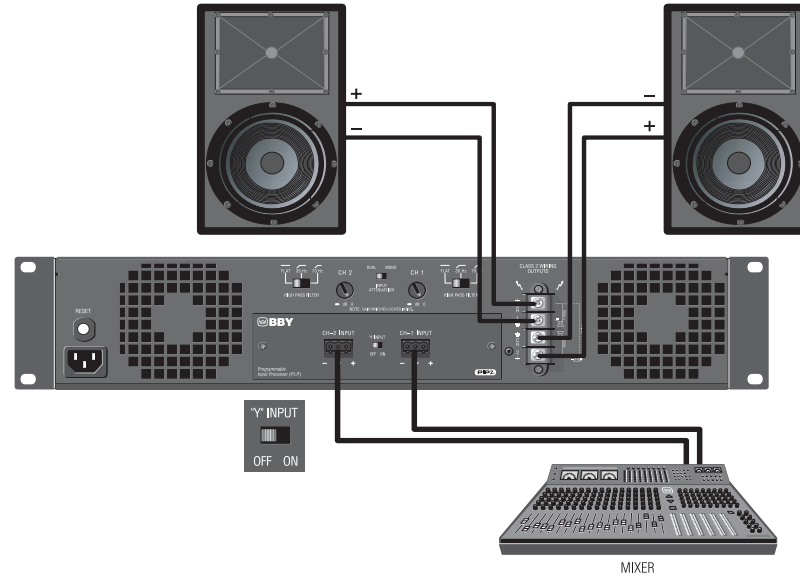

Figure 3.7 System Wiring, Dual Mode.

##### 3.6.2 Bridge-Mono 16/8/4 Mode

Typical input and output wiring, along with Attenuator and Mode Switch settings, are shown in Figures 3.8 and 3.9. Make sure the Mode switch is set to the "Mono" position when operating in Bridge-Mono mode.

**INPUTS:** Connect input wiring to Channel 1 only.

**OUTPUTS:** Connect the speaker across the positive terminals of each channel pair. Do not use the negative terminals of the channel pair when the pair is being operated in Bridge-Mono mode. Refer to Section 3.5 for output connector pin assignments.

NOTE: Crown provides a reference of wiring pin assignments for commonly used connector types in the Crown *Amplifier Application Guide* available at [www.crownaudio.com](http://www.crownaudio.com).

**NOTE: When operating in Bridge-Mono mode, turn down (full CCW) the Input Attenuator for Channel 2. The Channel-1 Input Attenuator works both channels.**

See the next page for constant-voltage operation.

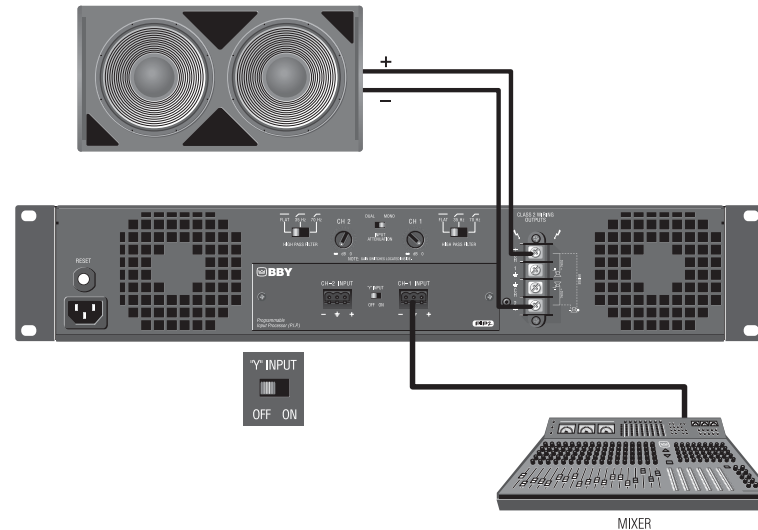

Figure 3.9 System Wiring, Bridge-Mono Mode

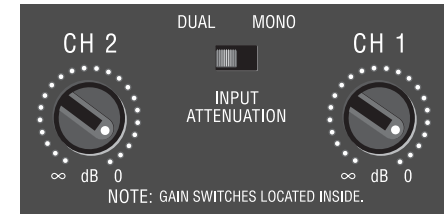

Figure 3.8 Attenuator and Mode-Switch Settings for Dual Mode

Always route the input and output wires in separate bundles.

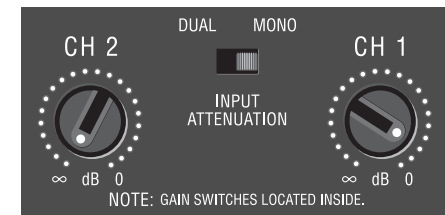

Figure 3.10 Attenuator and Mode-Switch Settings for Bridge-Mono Mode

### 3 Setup

#### 3.6.3 Dual 70V/100V Mode

Typical input and output wiring, along with Attenuator and Mode Switch settings are shown in Figures 3.10 and 3.11. Make sure the Mode switch is set to the "Dual" position when operating in Dual mode.

INPUTS: Connect input wiring to both channels.

OUTPUTS: In Dual Mode, the CTs 600/1200 can power 25/50/70V lines; the CTs 2000/3000 can power 25/50/70/100V lines. Connect each channel of output connectors to speakers that have the appropriate transformers.

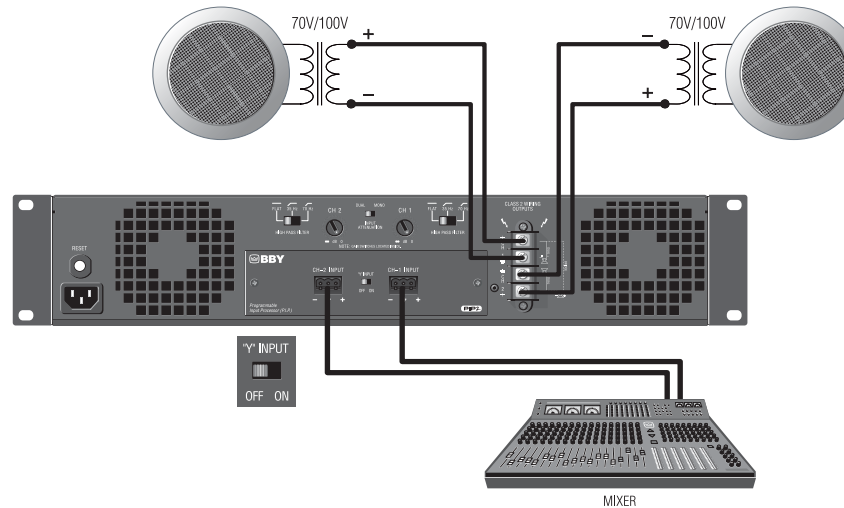

Figure 3.11 System Wiring and Y-Switch Setting for 70V/100V Operation

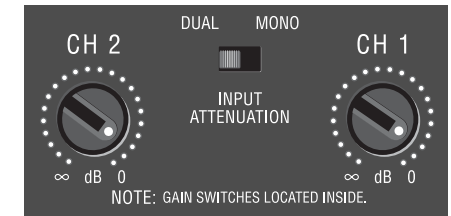

Figure 3.12 Attenuator and Mode-Switch Settings for 70V/100V Operation

Always route the input and output wires in separate bundles.

#### 3.6.4 Bridge-Mono 140V/200V Mode

Typical input and output wiring, along with Attenuator and Mode Switch settings are shown in Figures 3.12 and 3.13. Make sure the Mode switch is set to the "Mono" position when operating in Bridge-Mono mode.

INPUTS: Connect input wiring to Channel 1 only.

OUTPUTS: In Bridge-Mono mode, the CTs 600/1200 can power 140V lines; the CTs 2000/3000 can power 140V and 200V lines. Connect speakers with 140V or 200V transformers across the positive terminals of the channel pair. Do not use the negative terminals of the channel pair when the pair is being operated in Bridge-Mono mode. Refer to Section 3.5 for output connector pin assignments.

**NOTE: When operating in Bridge-Mono mode, turn down (full CCW) the Input Attenuator for Channel 2. The Channel-1 Input Attenuator works both channels.**

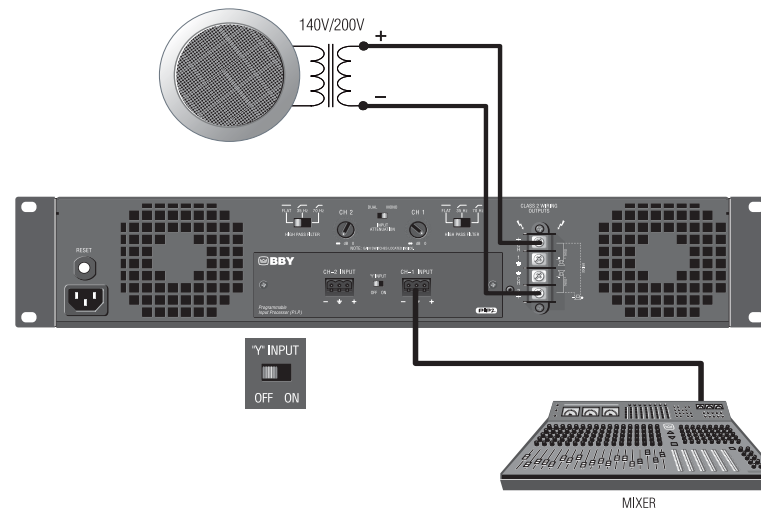

Figure 3.13 System Wiring and Y-Switch Setting for 140V/200V Operation

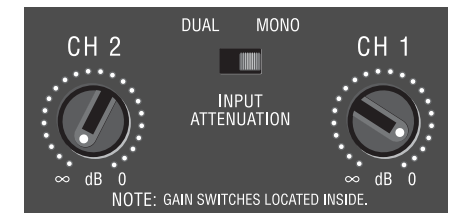

Figure 3.14 Attenuator and Mode-Switch Settings for 140V/200V Operation

### 3 Setup

#### 3.6.5 Dual Mode with "Y" Input

See Figure 3.14. This configuration feeds a mono signal to both Channel 1 and Channel 2. In the example in Figure 3.14, Channel 1 is driving a low-impedance loudspeaker and Channel 2 is driving a loudspeaker with a 70V transformer.

**INPUTS:**

Connect the signal to the Channel 1 input. On the back panel, set the "Y" Input Switch to ON.

**OUTPUTS:**

Connect the Channel 1 speaker's positive (+) lead to Channel 1 positive terminal of amp; repeat for negative (-).

Connect the Channel 2 speaker's positive (+) lead to Channel 2 positive terminal of amp; repeat for negative (-).

See Figure 3.15. Turn up both Input Attenuators and set the Mode Switch to Dual.

**NOTE:** When the "Y" Input Switch is on, the Channel 2 input can be used to daisy-chain to another amplifier.

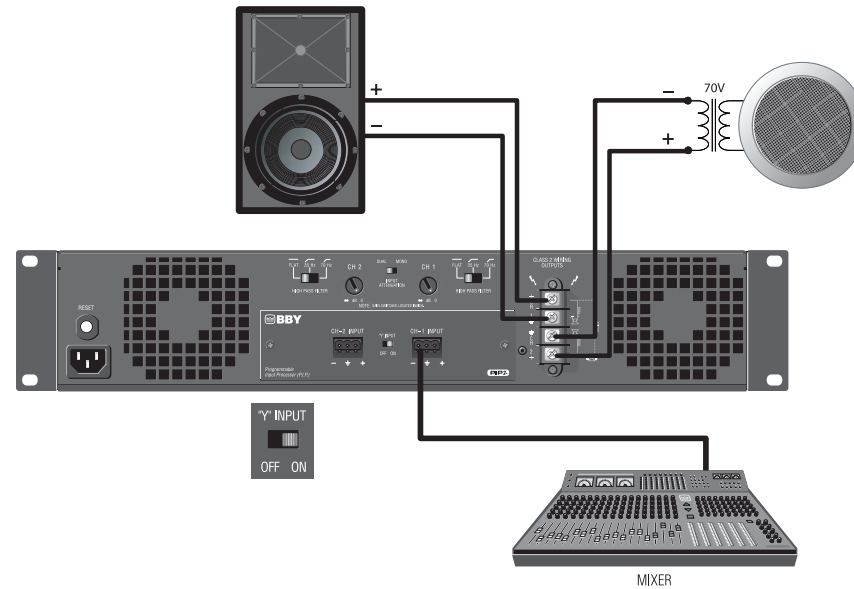
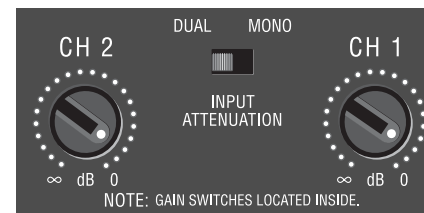

Figure 3.15 System Wiring for "Y" Input Mode

Always route the input and output wires in separate bundles.

Figure 3.16 Attenuator and Mode-Switch Settings for "Y" Input Mode



## 3 Setup

### 3.7 Connect to AC Mains

On the back panel, check whether your amplifier is labeled for 120V or 220-240V AC mains. Connect your amplifier to the corresponding AC mains power source (power outlet) with the supplied AC power cordset. First, connect the IEC end of the cordset to the IEC connector on the amplifier. Then, with the amplifier in the OFF position, plug the other end of the cordset into the AC mains.



**WARNING: The third prong of this connector (ground) is an important safety feature. Do not attempt to disable this ground connection by using an adapter or other methods.**

Amplifiers don't create energy. The AC mains voltage and current must be sufficient to deliver the power you expect. Check the amplifier's back-panel label which specifies the required AC mains voltage and frequency. The AC mains voltage must be no more than 15% above the required voltage, and no less than 25% below the required voltage. The AC mains frequency must be within the required frequency range. If you are unsure of the output voltage of your AC mains, please consult your electrician.

### 3.8 Startup Procedure

Use the following procedure when first turning on your amplifier:

1. Turn down the level of your audio source.
2. Turn down the level controls of the amplifier.
3. Turn on the "Power" switch. The Power indicator should glow. Wait for the "Ready" LED to illuminate.
4. Turn up the level of your audio source to an optimum level.
5. Turn up the Level controls on the amplifier until the desired loudness or power level is achieved. Verify that the Signal LED is flashing.
6. Turn down the level of your audio source to its normal range.

If you ever need to make any wiring or installation changes, don't forget to turn off the amplifier and disconnect the power cord.

For help with determining your system's optimum gain structure (signal levels) please refer to the Crown *Amplifier Application Guide*, available online at [www.crownaudio.com](http://www.crownaudio.com).

## 4 Operation

### 4.1 Precautions

Your amplifier is protected from internal and external faults, but you should still take the following precautions for optimum performance and safety:

1. Before use, your amplifier first must be configured for proper operation, including input and output wiring hookup. Improper wiring can result in serious operating difficulties. For information on wiring and configuration, please consult the Setup section of this manual or, for advanced setup techniques, consult Crown's *Amplifier Application Guide* available online at [www.crownaudio.com](http://www.crownaudio.com).
2. Use care when making connections, selecting signal sources and controlling the output level. The load you save may be your own!
3. Do not short the ground lead of an output cable to the input signal ground. This may form a ground loop and cause oscillations.
4. **Never connect the output to a power supply, battery or power main. Electrical shock may result.**
5. Tampering with the circuitry, or making unauthorized circuit changes may be hazardous and invalidates all agency listings.
6. Do not operate the amplifier with the red Clip LEDs constantly flashing.
7. Do not overdrive the mixer, which will cause clipped signal to be sent to the amplifier. Such signals will be reproduced with extreme accuracy, and loudspeaker damage may result.
8. Do not operate the amplifier with less than the rated load impedance. Due to the amplifier's output protection, such a configuration may result in premature clipping and speaker damage.



Remember: Crown is not liable for damage that results from overdriving other system components.

## 4 Operation

### 4.2 Front Panel Controls and Indicators

#### A. Fault Indicator

Red LED, one per channel, flashes when the amplifier output channel has stopped operating. Usually this means that the amplifier must be serviced.

#### B. Thermal Indicator

Red LED, one per channel, illuminates when the channel has shut down, or is very near shutting down, due to thermal stress or overload.

#### C. Ready Indicator

Green LED, one per channel, illuminates when the channel is initialized and ready to produce audio output. Indicator is off when the channel is set to standby mode via the System Architect or IQ Control Software packages.

### Signal Indicators

Three green LEDs per channel indicate the amplifier's input and output signal levels. From bottom to top the LEDs are:

**D. Signal:** input signal is above  $-40$  dBu.

**E.  $-20$  dB:** amplifier output is within 20 dB of clipping.

**F.  $-10$  dB:** amplifier output is within 10 dB of clipping.

#### G. Clip Indicator

Red LED, one per channel, illuminates when the channel's output signal reaches the onset of audible clipping. The Clip Indicator also will illuminate during Thermal Level Control (TLC) limiting or when the input compressor/limiter is protecting the amplifier from input overload.

#### H. Cooling Vents

Front-to-rear forced airflow.

#### I. Power Indicator

Blue LED indicates AC power has been applied and is within the safe operating range of the power supply. The LED will flash when the AC line voltage is approximately 15% above or 25% below the nominal rated value.

#### J. Data Indicator

Yellow LED indicates control activity. This LED is driven by the IQ-PIP2 module via the PIP2 interface. Note: Data indicator flashes only when the installed PIP module is polled for data, or is polled to see whether it is online.

#### K. Bridge Mode Indicator

Yellow LED illuminates when the rear-panel Mode Switch is set to the "Bridge" position.

#### L. Power Switch

Push-on / push-off switch.

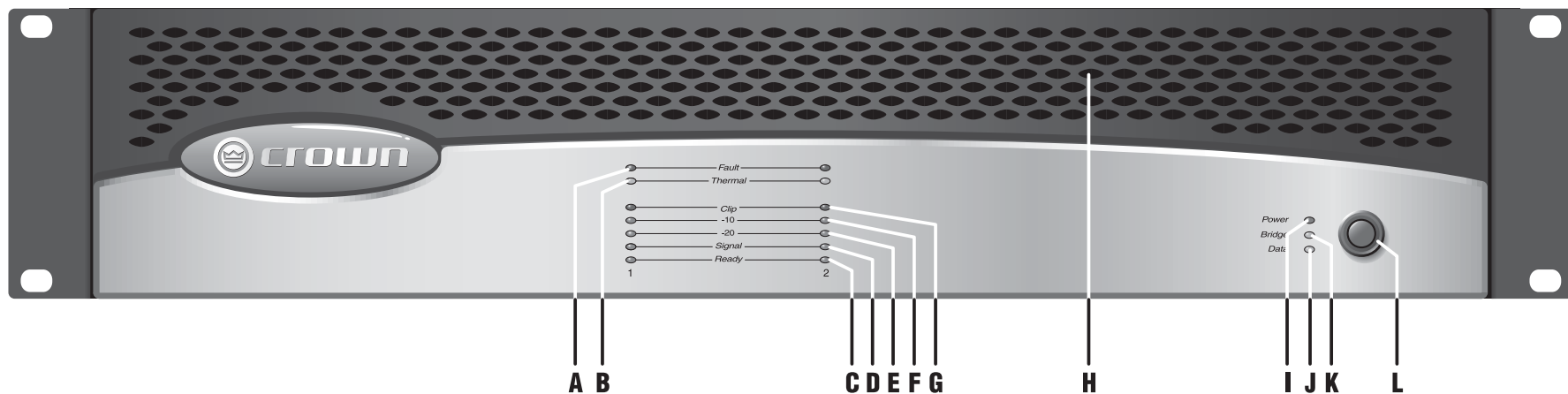

Figure 4.1 CTs 600 front panel.



## 4 Operation

### 4.3 Back Panel Controls and Connectors.

CTs 2000/3000 back panel is shown.  
CTs 600/1200 look slightly different near the Reset button.

#### M. Power Cord Connector

Standard 15 amp IEC inlet. A circuit breaker located near the IEC power inlet protects the amplifier from excessive AC current draw.

#### N. Reset Switch

Resets the circuit breaker that protects the power supply.

#### O. Ventilation Grille

Air flow is front to back. Do not block the ventilation grilles.

#### P. PIP™ Input Panel

PIP2-BBY module includes two balanced 3-pin removable barrier connectors. The "Y" Input Switch is described under letter R.

#### Sensitivity Switches

Behind the input panel are the Input Sensitivity Switches. One 3-position switch per channel selects various sensitivity settings. See Section 5.2.4 for details and diagram.

#### Q. Mode Switch

This two-position switch is used to select the amplifier's mode of operation: Dual or Bridge Mono.

Dual mode is used for 2/4/8 ohms, for 70V operation with the CTs 600/1200, and for 70/100V operation with the CTs 2000/3000.

Bridge mode is used for 4/8/16 ohms, for 140V operation with the CTs 600/1200, and for 100/140/200V operation with the CTs 2000/3000.

#### R. "Y" Input Switch

When set to ON, this switch parallels the input signals of the two channels, for use when the input signal is mono. The amplifier's channel outputs are still independent. The "Y" Input Switch also can

be used to daisy-chain the signal to another amplifier. See Section 3.6.5 for details.

#### S. Input Connectors

Balanced 3-pin terminal block connectors, one per channel.

#### T. Channel Level Controls

One 21-position detented rotary attenuator per channel, ranging from -100 dB to 0 dB gain.

#### U. High-Pass Filter

One 3-position switch per channel selects between OFF, 35Hz and 70Hz 3rd-order filters.

#### V. Speaker Connectors

One four-pole touch-proof terminal strip. Accepts up to 10 AWG terminal forks.

#### Output Cover (not shown)

This covers the output connectors, protecting users from the connectors' potentially high voltage. This cover is required for Class 2 wiring installations. See Section 3.5 for details on removing covers that have two holes.

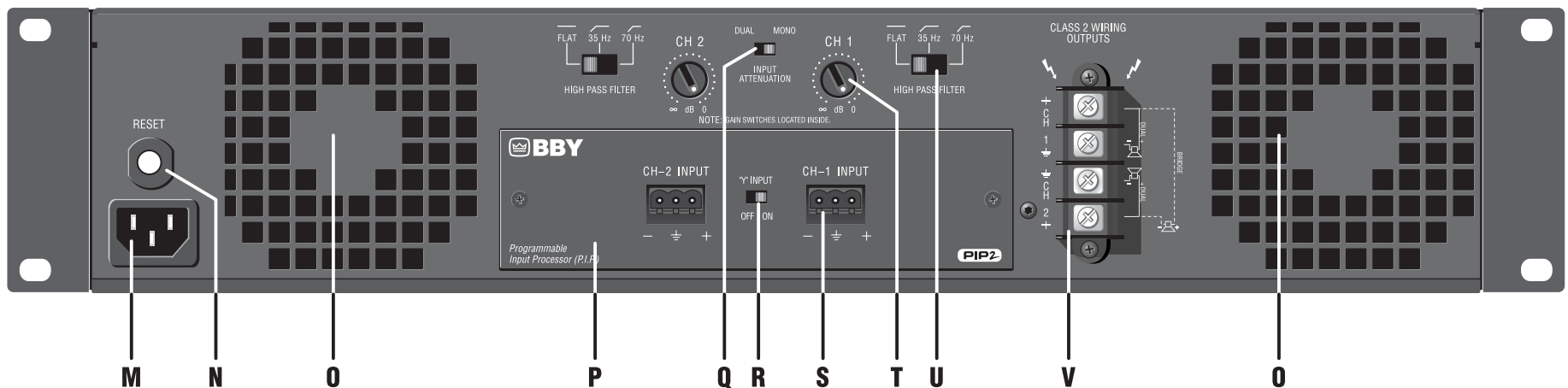

Figure 4.2 CTs 2000 and 3000 Back Panel Controls and Connectors

## 5 Advanced Features and Options

**NOTE:** For detailed information about these Crown amplifier features, please consult the *Crown Amplifier Application Guide*, available on the Crown website at [www.crownaudio.com](http://www.crownaudio.com)

### 5.1 Protection Systems

Your Crown amplifier provides extensive protection and diagnostic capabilities, including thermal level control, fault indicators, high-pass filtering, DC protect, AC under/over voltage protection, inrush limiting, and variable-speed fans.

#### 5.1.1 Thermal Level Control (TLC)

If the amplifier becomes too hot for safe operation, the light will shine brightly and TLC will engage the input compressor. By compressing the input, the amplifier will not generate as much heat and will have a chance to cool down. The degree of compression is proportional to the amount of overheating. This feature allows the show to go on, rather than having the amplifier shut down.

#### 5.1.2 Junction Temperature Simulation (JTS) (CTs 600/1200 only)

JTS circuitry simulates the operation of the amplifier's output transistors, and compares it against the transistors known Safe Operation Area (SOA). If JTS sees that more power is about to be asked of the output devices than they are capable of delivering under the present conditions, JTS immediately limits the drive level until it falls within the SOA. Limiting is proportional and kept to an absolute minimum—only what is required to prevent the possibility of output transistor damage.

This level of protection enables Crown to increase output transistor utilization while also greatly increasing amplifier reliability.

#### 5.1.3 Fault

The amplifier will light the Fault LED if the amplifier output stage stops operating. If this happens, see Section 8 for servicing information.

#### 5.1.4 High-Pass Filters

Very low frequency signals contain no useful musical energy, waste valuable amplifier power and headroom, and can be damaging to your speakers. Your Crown amplifier provides high-pass filters to remove these signals from each channel's output.

On the back panel are two 3-position 3rd-order high-pass filter switches (one per channel) with selections of Off, 35Hz and 70 Hz.

#### 5.1.5 Low-Pass Filters

Gaussian-approximation ultrasonic filters prevent ultrasonic feedback and HF burnout in drivers. This type of filter preserves transient response better than a Butterworth filter.

#### 5.1.6 AC Under/Over Voltage Protection

If the AC line voltage drops below 25% or rises above 15% of the nominal operating voltage of the amplifier, the amplifier's power supply turns off and the blue Power LED flashes. The amplifier will turn back on when the AC line voltage returns to safe operating levels (within +15% / -25%).

#### 5.1.7 Circuit Breaker

A circuit breaker located near the IEC power inlet protects the amplifier from excessive AC current draw.

#### 5.1.8 DC Output Servo

The output servo circuit protects your drivers by eliminating DC offset, even in the presence of very large asymmetrical signals.

#### 5.1.9 Inrush Limiting

A soft-start circuit in the power supply minimizes the amplifier's current draw during power-on.

#### 5.1.10 Variable-speed Fans

Two continuously variable speed fans direct the airflow through the amplifier for cooling.

### 5.2 Advanced Features

#### 5.2.1 Switching Power Supply

Crown's Switching Power Supply minimizes the amplifier's weight.

Typical non-switching power supplies require large, heavy transformers in order to produce the required power at the output stage. These transformers must be large to operate at 50 to 60 Hz (standard AC supplied by the power company).

By contrast, switching power supplies can operate with a much smaller (and lighter) transformer because they first convert the AC up to a much higher frequency, thereby reducing waste.

The power supply is voltage-specific, allowing use in regions using 120V or 240V.

#### 5.2.2 Input Compressor

Prevent input/output overload.

#### 5.2.3 Sleep Circuit

Lowers standby power consumption by shutting down the high-voltage supplies during idle periods.

NOTE: By default, the sleep circuit is not active on the CTs 600/1200, but may be activated as a service option.

## 5 Advanced Features and Options

### 5.2.4 Input Sensitivity Switches

See Figures 5.1 and 5.2. To access the Input Sensitivity Switches, turn off the amplifier and remove the PIP2-BBY Input Panel. The switches are in the top surface of the cavity behind the Input Panel. One 3-position switch per channel selects among these settings: CTs 600/1200: 1.4V (8/4 ohms), 26 dB gain, and 1.4V (70V operation). CTs 2000/3000: 1.4V (8/4 ohms), 26 dB gain, and 1.4V (70V) / 2V (100V). The Specifications chapter lists the input sensitivity for the 26 dB gain setting.



Figure 5.1 Input Sensitivity Switches for CTs 600/1200

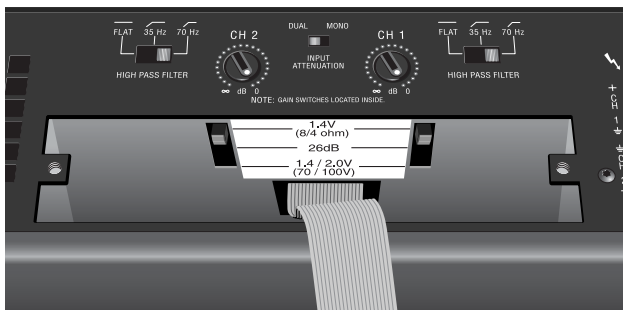

Figure 5.2 Input Sensitivity Switches for CTs 2000/3000

### 5.3 Options

**T-170V:** See Figure 5.3. This is an autoformer that allows 100V output from the CTs 600/1200, and allows other amplifiers without direct constant voltage output to be easily integrated into distributed systems.

**TP-170V:** See Figure 5.4. This is a rack-mountable panel with four autoformers as described above.

### PIP Modules

Versatile PIP (Programmable Input Processor) modules provide flexible expansion features that can be added to customize the amplifier. PIP modules plug into the connector inside the back panel of the amplifier. PIP modules are available with features ranging from error-driven compressor/limiters to crossovers to remote control and monitoring via IQwic™ or System Architect software. Your amplifier is a PIP2 amplifier, which means it can take advantage of the many advanced features found in PIP2 modules. The CTs Series 2-channel models do not accept earlier PIP modules.

Visit the Crown website at [www.crownaudio.com](http://www.crownaudio.com), or contact Crown Customer Service, for descriptions of available PIP and PIP2 modules.

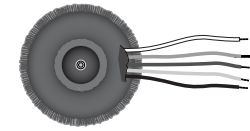

Figure 5.3 T-170V

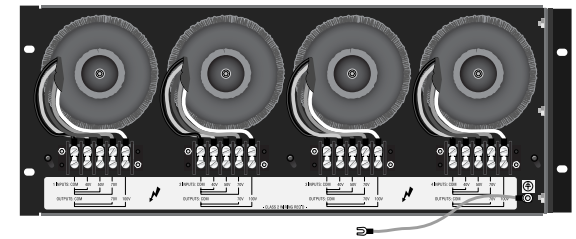

Figure 5.4 TP-170V (back view)

## 5 Advanced Features and Options

### 5.3.1 Nominal Attenuation Settings

The signal level for each input can be attenuated repeatably by adjusting the 21-step Level Control (see Section 4.3). Figure 5.5 shows the attenuation in dB for each detent. The setting of the input-sensitivity switch varies the actual attenuation as shown.

**Attenuation in dB**

Detent	26 dB	Tolerance (dB)	4/8 ohm or 70/100V
0 (full CCW)	OFF	—	OFF
1	48.0	±6	54.0
2	36.0	±6	42.0
3	24.0	±3	30.0
4	21.0	±3	26.0
5	18.0	±3	24.0
6	15.0	±3	22.0
7	13.5	±3	20.0
8	12.0	±1.5	18.0
9	10.5	±1.5	16.0
10	9.0	±1.5	14.5
11	8.0	±1.5	13.0
12	7.0	±1.5	11.0
13	6.0	±1	9.5
14	5.0	±1	8.0
15	4.0	±1	6.5
16	3.0	±1	5.0
17	2.0	±1	3.5
18	1.0	±1	1.5
19	0.5	+1 -5	0.5
20 (full CW)	0.0	—	0.0

Figure 5.1 Level-control Attenuation per Detent for CTs 2-Channel Amplifiers

## 6 Troubleshooting

**CONDITION: Power indicator is off.**

**POSSIBLE REASON**

- The amplifier has lost AC power.
- The amplifier's Power switch is off.
- The amplifier is not plugged into the power receptacle.
- The amplifier output level is so high that the power supply circuit breaker has tripped. Allow the unit to cool. Turn down the Level controls. Press the Reset Switch on the back panel.

**CONDITION: Fault indicator is flashing.**

**POSSIBLE REASON:**

- The amplifier channel has stopped operating. Refer the unit to an authorized Crown Service Center.

**CONDITION: Power indicator is flashing.**

**POSSIBLE REASON:**

- The AC line voltage has dropped below 20% or has risen above 10% of the nominal line voltage of the power supply.

**CONDITION: Distorted sound.**

**POSSIBLE REASON:**

- Load is wired incorrectly or Stereo/Mono mode switch is set incorrectly. Check both.
- Input is overloaded by a signal level that is too high. Turn down your amplifier level controls, or turn down the input signal, until the clip light goes out.

Note: If the signal sounds distorted even though the Clip LED is off, the input signal may be distorted before it reaches the amplifier input. Check gain staging and output levels of the mixer or preamp.

**CONDITION: Thermal indicator is on.**

**POSSIBLE REASON:**



- The amplifier is becoming too hot for safe operation. Allow amplifier to cool. Check for loads less than 2 ohms, and for excessive input levels. Check for proper ventilation and proper mode-switch setting.

**Key**

- Off
- ◐ Flashing
- Off/Flashing/On
- ☀ Lit

"Off/Flashing/On" above means that the LED can be off, or flashing, or on.

## 6 Troubleshooting

Fault ———● Thermal ———●  Clip ———● -10 ———● -20 ———● Signal ———☀ Ready ———☀	Power ☀ Bridge ○ Data ○	 <p><b>CONDITION: No sound, even though the amp has power.</b> Power LED is on without flashing and the amp is receiving an input signal. Signal indicator is flashing.</p> <p><b>POSSIBLE REASON:</b></p> <ul style="list-style-type: none"> <li>• Speakers not connected.</li> <li>• Open circuit due to speaker failure.</li> </ul>
Fault ———● Thermal ———●  Clip ———◐ -10 ———◐ -20 ———◐ Signal ———◐ Ready ———☀	Power ☀ Bridge ○ Data ○	 <ul style="list-style-type: none"> <li>• There is a short on the amplifier output. First disconnect your speakers from the affected channel(s) one by one to determine if one of the loads is shorted.</li> </ul>
Fault ———● Thermal ———●  Clip ———● -10 ———● -20 ———● Signal ———● Ready ———●	Power ☀ Bridge ● Data ●	<p>Ready LED is off. Channel has been set to standby mode via the control system.</p> 

Fault ———● Thermal ———●  Clip ———● -10 ———● -20 ———● Signal ———● Ready ———☀	Power ☀ Bridge ○ Data ○	<p><b>CONDITION: No input signal.</b> Signal indicator is not flashing even though audio is applied, and the channel is ready.</p> <p><b>POSSIBLE REASON:</b></p> <ul style="list-style-type: none"> <li>• Input signal level is very low.</li> <li>• Level controls are turned down.</li> </ul>
--	-------------------------------	--

Power ☀ Bridge ○ Data ●		<p><b>CONDITION: Data indicator not flashing, even though PIP module is installed and host computer control software is active.</b></p> <p><b>POSSIBLE REASON:</b></p> <ul style="list-style-type: none"> <li>• Cable between computer and PIP module is broken or not connected.</li> </ul> <p>Note: Data indicator flashes only when the installed PIP2 module is polled for data, or is polled to see whether it is online.</p>
-------------------------------	---	--

Power ☀ Bridge ☀ Data ●		<p><b>CONDITION: Bridge LED is lit.</b></p> <p><b>POSSIBLE REASON:</b></p> <ul style="list-style-type: none"> <li>• Amplifier is in bridge-mono mode.</li> </ul>
-------------------------------	---	--

<b>Key</b>	● Off
	◐ Flashing
	○ Off/Flashing/On
	☀ Lit

"Off/Flashing/On" above means that the LED can be off, or flashing, or on.

## 7 Specifications

Minimum Guaranteed Power (20 Hz - 20 kHz)	CTs 600 Power at 0.1% THD	CTs 1200 Power at 0.1% THD	CTs 2000 Power at 0.35% THD	CTs 3000 Power at 0.35% THD
2-ohm Dual (per ch.)	150W	250W	1000W	1500W
4-ohm Dual (per ch.)	300W	600W	1000W	1500W
8-ohm Dual (per ch.)	300W	600W	1000W	1250W
16-ohm Dual (per ch.)	300W	300W	625W	625W
70V Dual (per ch.)	300W	600W	1000W	1500W
100V Dual (per ch.)	300W*	600W*	1000W	1500W
4-ohm Bridge	300W	500W	2000W	3000W
8-ohm Bridge	600W	1200W	2000W	3000W
16-ohm Bridge	600W	1200W	2000W	2500W
100V Bridge	600W*	1200W*	2000W	3000W
140V Bridge	600W	1200W	2000W	3000W
200V Bridge	600W*	1200W*	2000W	3000W
Performance	CTs 600	CTs 1200	CTs 2000	CTs 3000
Frequency Response (at 1 watt, 20 Hz - 20 kHz)	± 0.25 dB	± 0.25 dB	± 0.25 dB	± 0.25 dB
Signal to Noise Ratio (ref. rated power, 20 Hz to 20 kHz, A-weighted)	< 105 dB	< 105 dB	< 105 dB	< 105 dB
Total Harmonic Distortion (THD) at full rated power, from 20 Hz to 20 kHz	< 0.1%	< 0.1%	< 0.35%	< 0.35%
Intermodulation Distortion (IMD) 60 Hz and 7 kHz at 4:1, from -40 dB to full rated power	< 0.1%	< 0.1%	< 0.35%	< 0.35%
Damping Factor: 10 Hz to 100 Hz	> 3000	> 3000	> 3000	> 3000
Crosstalk (below rated power) 20 Hz to 1kHz	> 80 dB	> 80 dB	> 80 dB	> 80 dB
Common Mode Rejection (CMR) (20 Hz to 1 kHz, typical)	50 dB	50 dB	50 dB	50 dB
DC Output Offset	< 2 mV	< 2mV	< 2 mV	< 2 mV
Input Impedance nominally balanced, nominally unbalanced	10 k ohms, 5 k ohms	10 k ohms, 5 k ohms	10 k ohms, 5 k ohms	10 k ohms, 5 k ohms

\* With T-170V or TP-170V.

## 7 Specifications

Performance	CTs 600	CTs 1200	CTs 2000	CTs 3000
Maximum Input Level Before input compression Absolute maximum	+20 dBu + 32 dBu	+20 dBu + 32 dBu	+20 dBu + 32 dBu	+20 dBu + 32 dBu
Load Impedance (Note: Safe with all types of loads) Stereo	2, 4, 8, 16 ohms, 70V, and 100V*	2, 4, 8, 16 ohms, 70V, and 100V*	2, 4, 8, 16, 70V, and 100V	2, 4, 8, 16, 70V, and 100V
Bridge Mono	4, 8, 16, 100V*, 140V and 200V*	4, 8, 16, 100V*, 140V and 200V*	4, 8, 16, 140V , 200V	4, 8, 16, 140V, 200V
Voltage Gain (at maximum level setting) 8/4 Ohm Operation 26 dB 70V Operation 100V Operation	35:1 (31 dB) 20:1 (26 dB) 50:1 (34 dB)	50:1 (34 dB) 20:1 (26 dB) 50:1 (34 dB)	63.9:1 (36 dB) 20:1 (26 dB) 50:1 (34 dB) 50:1 (34 dB)	71.4:1 (37 dB) 20:1 (26 dB) 50:1 (34 dB) 50:1 (34 dB)
Input Sensitivity 2/4/8 ohms 70V 100 V 26 dB gain	1.4V 1.4V 4 ohm load: 1.74V. 8 ohm load: 2.46V	1.4V 1.4V 4 ohm load: 2.46V. 8 ohm load: 3.47V	1.4V 1.4V 2.0V 4 ohm load: 3.17V. 8 ohm load: 4.48V	1.4V 1.4V 2.0V 4 ohm load: 3.88V. 8 ohm load: 5.01V
Required AC Mains (+15%, – 25%)	120V/60 Hz, 230V/50 Hz	120V/60 Hz, 230V/50 Hz	120V/60 Hz, 230V/50 Hz	120V/60 Hz, 230V/50 Hz
Power Draw at Idle (120 VAC mains)	24W (Standby Mode)	24W (Standby Mode)	35W (Standby Mode)	35W (Standby Mode)
Overall Group Delay	< 120 usec	< 120 usec	< 120 usec	< 120 usec
Cooling	Continuously variable speed forced air, front-to-back airflow	Continuously variable speed forced air, front-to-back airflow	Continuously variable speed forced air, front-to-back airflow	Continuously variable speed forced air, front-to-back airflow
Dimensions Width Height Depth	19 in. (48.3 cm.) 3.5 in. (8.9 cm.) 14.25 in. (36.2 cm.)	19 in. (48.3 cm.) 3.5 in. (8.9 cm.) 14.25 in. (36.2 cm.)	19 in. (48.3 cm.) 3.5 in. (8.9 cm.) 14.25 in. (36.2 cm.)	19 in. (48.3 cm.) 3.5 in. (8.9 cm.) 14.25 in. (36.2 cm.)
Net Weight Shipping Weight	22.8 lb (10.3 kg), 27.7 lb (12.6 kg)	23.4 lb (10.6 kg), 28.3 lb ( 12.8 kg)	27.0 lb (12.2 kg) 32.0 lb (14.5 kg)	27.7 lb (12.6 kg) 32.7 lb (14.8 kg)

\* With T-170V or TP-170V.



## 7 Specifications

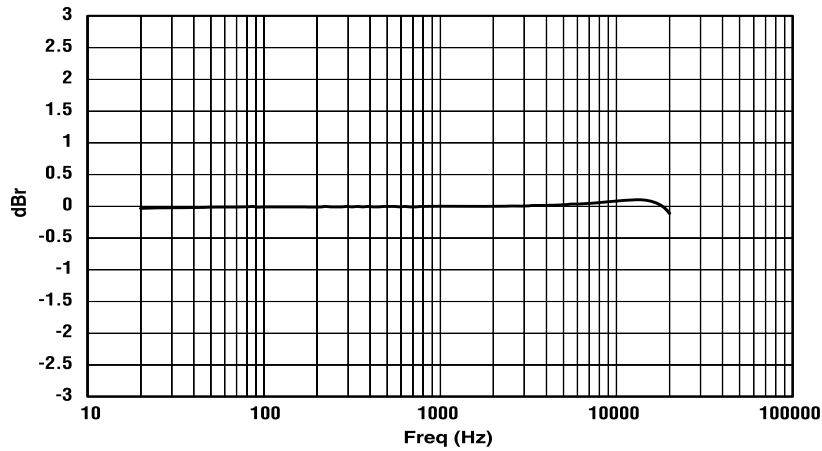

Figure 7.1 CTs 600/1200 Typical Frequency Response (1 W, 8 ohms)

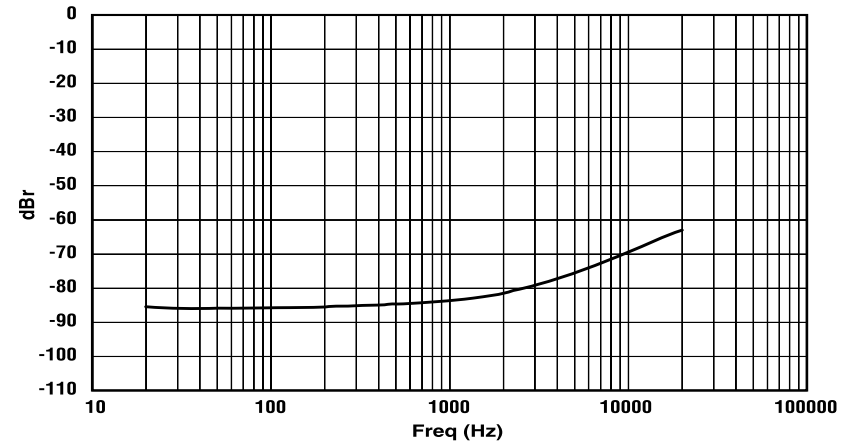

Figure 7.2 CTs 600/1200 Typical Crosstalk vs. Frequency

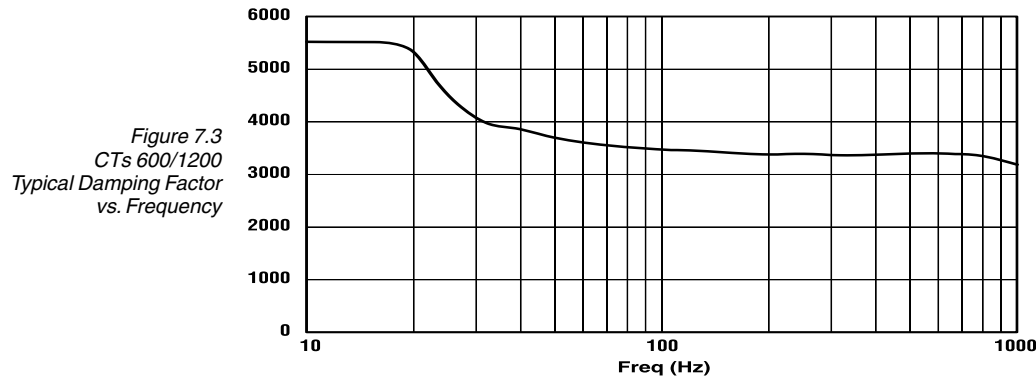

Figure 7.3  
CTs 600/1200  
Typical Damping Factor  
vs. Frequency

## 7 Specifications

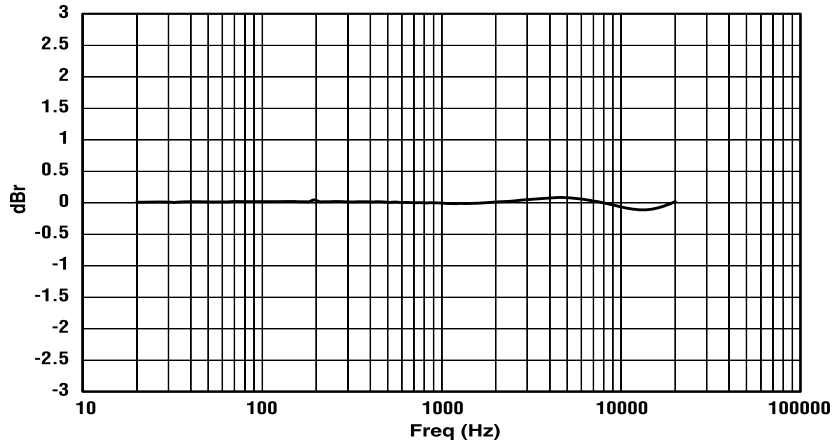

Figure 7.4 CTs 2000/3000 Typical Frequency Response (1W)

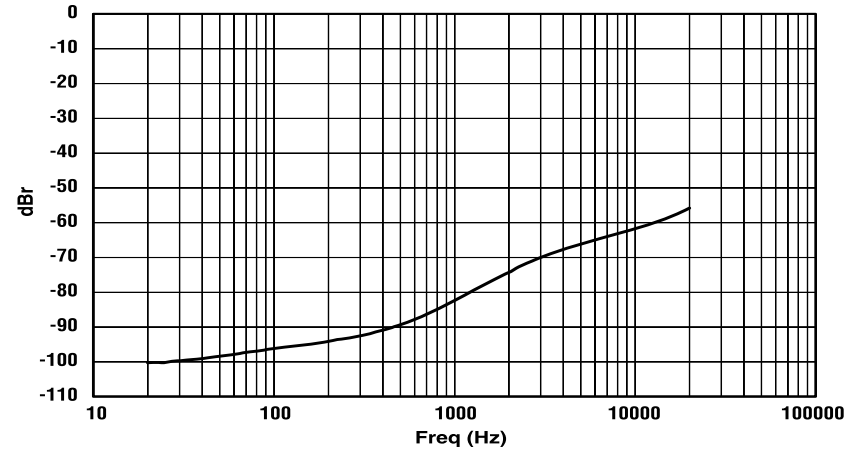

Figure 7.5 CTs 2000/3000 Typical Crosstalk vs. Frequency

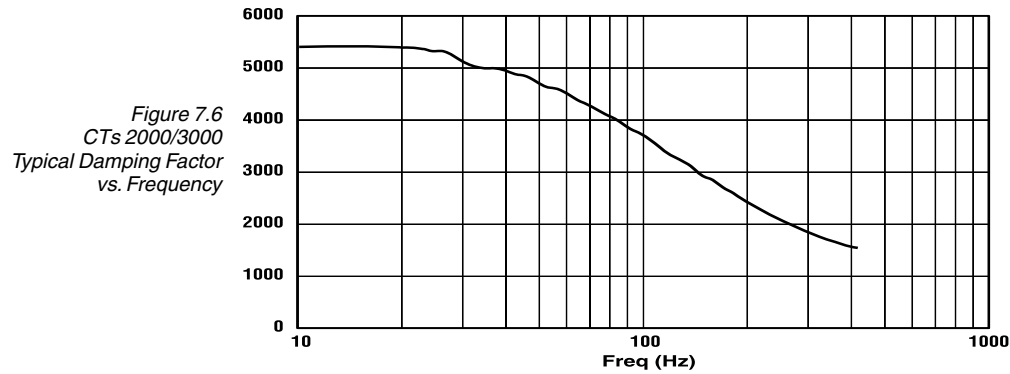

Figure 7.6  
CTs 2000/3000  
Typical Damping Factor  
vs. Frequency

## 8 AC Power Draw and Thermal Dissipation

### AC Power Draw and Thermal Dissipation:

Pink noise 12dB crest factor, bandwidth limited 22Hz to 22kHz.

Typical line impedance used.

Measurements made with 120VAC mains. Line current figures for 230VAC units derived by multiplying 120VAC figures by 0.5.

Data based on all channels driven.

CTs 600									
	Load	Rated Power	Line Current 120VAC	Line Current 230VAC	Watts			Thermal Dissipation	
					watts in	watts out	dissipated	Btu/hr	kcal/hr
At Idle					60	0	60	205	52
1/8th Power Pink Noise Typical of program material just at clip.	8 Ohms/Ch. 16 Ohms Bridge	300x2 600	5.8	2.9	461	78	383	1307	330
	4 Ohms/Ch. 8 Ohms Bridge	300x2 600	7.4	3.7	631	78	554	1890	477
	2 Ohms/Ch. 4 Ohms Bridge	150x2 300	7.0	3.5	583	38	545	1859	469
	70V/Ch. 140/200V Bridge	300x2 600	4.2	2.1	336	75	261	892	225
1/3rd Power Pink Noise Typical of program material with severe clipping.	8 Ohms/Ch. 16 Ohms Bridge	300x2 600	8.6	4.3	716	200	516	1760	444
	4 Ohms/Ch. 8 Ohms Bridge	300x2 600	11.3	5.6	968	204	764	2608	657
	2 Ohms/Ch. 4 Ohms Bridge	150x2 300	10.8	5.4	964	102	862	2942	742
	70V/Ch. 140/200V Bridge	300x2 600	6.5	3.3	527	207	320	1091	275

## 8 AC Power Draw and Thermal Dissipation

### AC Power Draw and Thermal Dissipation:

Pink noise 12dB crest factor, bandwidth limited 22Hz to 22kHz.

Typical line impedance used.

Measurements made with 120VAC mains. Line current figures for 230VAC units derived by multiplying 120VAC figures by 0.5.

Data based on all channels driven.

CTs 1200									
	Load	Rated Power	Line Current 120VAC	Line Current 230VAC	Watts			Thermal Dissipation	
					watts in	watts out	dissipated	Btu/hr	kcal/hr
At Idle					60	0	60	205	52
1/8th Power Pink Noise Typical of program material just at clip.	8 Ohms/Ch. 16 Ohms Bridge	600x2 1200	7.6	3.8	641	157	484	1651	416
	4 Ohms/Ch. 8 Ohms Bridge	600x2 1200	10.0	5.0	872	151	720	2458	620
	2 Ohms/Ch. 4 Ohms Bridge	250x2 500	8.8	4.4	1330	405	925	3158	796
	100V/Ch. 140/200V Bridge	600x2 1200	7.6	3.8	641	157	484	1651	416
1/3rd Power Pink Noise Typical of program material with severe clipping.	8 Ohms/Ch. 16 Ohms Bridge	600x2 1200	11.5	5.7	996	403	593	2025	511
	4 Ohms/Ch. 8 Ohms Bridge	600x2 1200	15.5	7.8	1372	405	967	3300	832
	2 Ohms/Ch. 4 Ohms Bridge	250x2 500	13.4	6.7	1217	168	1050	3582	903
	70V/Ch. 140/200V Bridge	600x2 1200	11.5	5.7	996	403	593	2025	511

## 8 AC Power Draw and Thermal Dissipation

### AC Power Draw and Thermal Dissipation:

Pink noise 12dB crest factor, bandwidth limited 22Hz to 22kHz.

Typical line impedance used.

Measurements made with 120VAC mains. Data based on all channels driven.

Line current figures for 230VAC units derived by multiplying 120VAC figures by 0.5.

Line current figures for 100VAC units (not shown) are 1.2 times the line current figures of 120VAC units.

Power draw ("watts in") of 100VAC units is the same as power draw of 120VAC units.

CTs 2000									
	Load	Rated Power	Line Current 120VAC	Line Current 230VAC	Watts			Thermal Dissipation	
					watts in	watts out	dissipated	Btu/hr	kcal/hr
At Idle (sleep mode)					40	0	40	137	34
1/8th Power Pink Noise Typical of program material just at clip.	8 Ohms/Ch. 16 Ohms Bridge	1000x2 2000	6.6	3.3	546	256	290	988	249
	4 Ohms/Ch. 8 Ohms Bridge	1000x2 2000	7.0	3.5	563	255	307	1049	264
	2 Ohms/Ch. 4 Ohms Bridge	1000x2 2000	7.2	3.6	602	251	351	1198	302
	70/100V/Ch. 140/200V Bridge	1000x2 2000	6.7	3.4	639	257	382	1304	329
1/3rd Power Pink Noise Typical of program material with severe clipping.	8 Ohms/Ch. 16 Ohms Bridge	1000x2 2000	11.3	5.6	980	676	304	1036	261
	4 Ohms/Ch. 8 Ohms Bridge	1000x2 2000	12.3	6.2	1064	672	392	1338	337
	2 Ohms/Ch. 4 Ohms Bridge	1000x2 2000	13.7	6.9	1190	705	485	1655	417
	70/100V/Ch. 140/200V Bridge	1000x2 2000	11.6	5.8	990	674	316	1080	272

## 8 AC Power Draw and Thermal Dissipation

### AC Power Draw and Thermal Dissipation:

Pink noise 12dB crest factor, bandwidth limited 22Hz to 22kHz.

Typical line impedance used.

Measurements made with 120VAC mains. Data based on all channels driven.

Line current figures for 230VAC units derived by multiplying 120VAC figures by 0.5.

Line current figures for 100VAC units (not shown) are 1.2 times the line current figures of 120VAC units.

Power draw ("watts in") of 100VAC units is the same as power draw of 120VAC units.

CTs 3000									
	Load	Rated Power	Line Current 120VAC	Line Current 230VAC	Watts			Thermal Dissipation	
					watts in	watts out	dissipated	Btu/hr	kcal/hr
At Idle (sleep mode)					40	0	40	137	34
1/8th Power Pink Noise Typical of program material just at clip.	8 Ohms/Ch. 16 Ohms Bridge	1000x2 2000	7.2	3.6	579	313	266	907	229
	4 Ohms/Ch. 8 Ohms Bridge	1000x2 2000	8.5	4.2	697	381	316	1079	272
	2 Ohms/Ch. 4 Ohms Bridge	1000x2 2000	9.6	4.8	790	384	405	1384	349
	70/100V/Ch. 140/200V Bridge	1000x2 2000	7.2	3.6	579	313	266	907	229
1/3rd Power Pink Noise Typical of program material with severe clipping.	8 Ohms/Ch. 16 Ohms Bridge	1250x2 2500	13.7	6.8	1196	835	360	1230	310
	4 Ohms/Ch. 8 Ohms Bridge	1500x2 3000	16.2	8.1	1469	1010	459	1565	395
	2 Ohms/Ch. 4 Ohms Bridge	1500x2 3000	19.2	9.6	1686	1024	662	2259	570
	70/100V/Ch. 140/200V Bridge	1500x2 3000	13.7	6.8	1196	835	360	1230	310

# CTs Multi-Channel Series

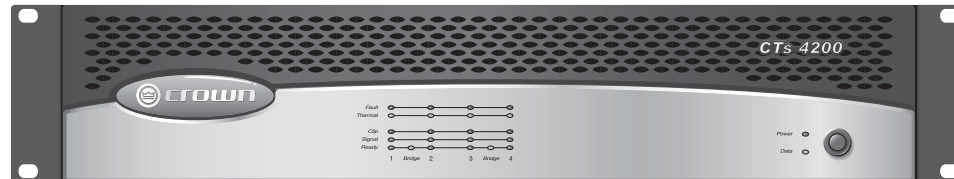

**CTs 4200**

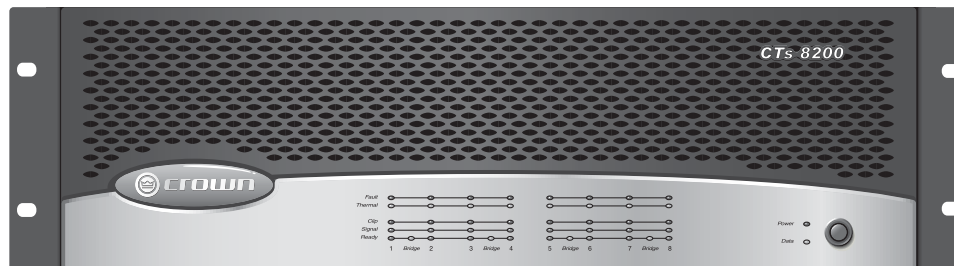

**CTs 8200**

Crown Audio, Inc.

## DECLARATION of CONFORMITY

ISSUED BY: Crown Audio, Inc.  
1718 W. Mishawaka Road  
Elkhart, Indiana 46517 U.S.A.

FOR COMPLIANCE QUESTIONS ONLY: Sue Whitfield  
574-294-8289  
swhitfield@crowintl.com

**European Representative's Name and Address:**

David Budge  
10 Harvest Close  
Yateley GU46 6YS  
United Kingdom

**Equipment Type:** Commercial Audio Power Amplifiers**Family Name:** CTs**Model Names:** CTs 4200A, CTs 8200A**EMC Standards:**

**EN 55103-1:1995** Electromagnetic Compatibility - Product Family Standard for Audio, Video, Audio-Visual and Entertainment Lighting Control Apparatus for Professional Use, Part 1: Emissions

**EN 55103-1:1995** Magnetic Field Emissions-Annex A @ 10 cm and 1 M

**EN 61000-3-2:1995+A14:2000** Limits for Harmonic Current Emissions (equipment input current  $\leq 16$ A per phase)

**EN 61000-3-3:1995** Limitation of Voltage Fluctuations and Flicker in Low-Voltage Supply Systems Rated Current  $\leq 16$ A

**EN 55022:1992 + A1: 1995 & A2:1997** Limits and Methods of Measurement of Radio Disturbance Characteristics of ITE: Radiated, Class B Limits; Conducted, Class B

**EN 55103-2:1996** Electromagnetic Compatibility - Product Family Standard for Audio, Video, Audio-Visual and Entertainment Lighting Control Apparatus for Professional Use, Part 2: Immunity

**EN 61000-4-2:1995** Electrostatic Discharge Immunity (Environment E2-Criteria B, 4k V Contact, 8k V Air Discharge)

**EN 61000-4-3:1996** Radiated, Radio-Frequency, Electromagnetic Immunity (Environment E2, criteria A)

**EN 61000-4-4:1995** Electrical Fast Transient/Burst Immunity (Criteria B)

**EN 61000-4-5:1995** Surge Immunity (Criteria B)

**EN 61000-4-6:1996** Immunity to Conducted Disturbances Induced by Radio-Frequency Fields (Criteria A)

**EN 61000-4-11:1994** Voltage Dips, Short Interruptions and Voltage Variation

**Safety Standard:**

**EN 60065: 1998** Safety Requirements - Audio Video and Similar Electronic Apparatus

I certify that the product identified above conforms to the requirements of the EMC Council Directive 89/336/EEC as amended by 92/31/EEC, and the Low Voltage Directive 73/23/EES as amended by 93/68/EEC.

Signed



Larry Coburn

Title: Senior Vice President of Manufacturing

Date of Issue: March 1, 2002



## CTs 4200

### Dual

4 Channels Driven	1 kHz	20 Hz–20 kHz
4-ohm (per ch.)	<b>260W</b>	<b>215W</b>
8-ohm (per ch.)	<b>180W</b>	<b>190W</b>
70V (per ch.)	<b>220W*</b>	

### 1 Channel Driven

1 Channel Driven	1 kHz	20 Hz–20 kHz
4-ohm (per ch.)	<b>270W</b>	<b>225W</b>
8-ohm (per ch.)	<b>220W</b>	<b>210W</b>
70V (per ch.)	<b>250W</b>	<b>245W*</b>

### Bridge-Mono

2 Channel-Pairs Driven	1 kHz	20 Hz–20 kHz
8-ohm (per ch. pair)	<b>520W</b>	<b>430W</b>
16-ohm (per ch. pair)	<b>400W</b>	<b>380W</b>
100V (per ch. pair)	<b>220W</b>	<b>220W*</b>

### 1 Channel-Pair Driven

1 Channel-Pair Driven	1 kHz	20 Hz–20 kHz
8-ohm (per ch. pair)	<b>560W</b>	<b>450W</b>
16-ohm (per ch. pair)	<b>440W</b>	<b>420W</b>
100V (per ch. pair)	<b>250W</b>	<b>245W*</b>

\* Constant Voltage full bandwidth power ratings support 100Hz - 20kHz due to automatic High-Pass Filters.

Maximum Average Power in watts with 0.1% THD.



## CTs 8200

### Dual

8 Channels Driven	1 kHz	20 Hz–20 kHz
4-ohm (per ch.)	<b>200W</b>	<b>175W</b>
8-ohm (per ch.)	<b>160W</b>	<b>155W</b>
70V (per ch.)	<b>200W</b>	<b>185W*</b>

### 1 Channel Driven

1 Channel Driven	1 kHz	20 Hz–20 kHz
4-ohm (per ch.)	<b>270W</b>	<b>230W</b>
8-ohm (per ch.)	<b>220W</b>	<b>220W</b>
70V (per ch.)	<b>250W</b>	<b>230W*</b>

### Bridge-Mono

4 Channel-Pairs Driven	1 kHz	20 Hz–20 kHz
8-ohm (per ch. pair)	<b>400W</b>	<b>350W</b>
16-ohm (per ch. pair)	<b>320W</b>	<b>310W</b>
100V (per ch. pair)	<b>200W</b>	<b>185W*</b>

### 1 Channel-Pair Driven

1 Channel-Pair Driven	1 kHz	20 Hz–20 kHz
8-ohm (per ch. pair)	<b>540W</b>	<b>460W</b>
16-ohm (per ch. pair)	<b>440W</b>	<b>440W</b>
100V (per ch. pair)	<b>250W</b>	<b>230W*</b>

\* Constant Voltage full bandwidth power ratings support 100Hz - 20kHz due to automatic High-Pass Filters.

Maximum Average Power in watts with 0.1% THD.

## 1 Welcome

Building on the foundation of the *Com-Tech*® Series, Crown's CTs Series offers new flexibility and value for installed sound applications. The Com-Tech Series were the first to offer independent selection of high- and low-impedance operation for a specific channel, and CTs Series amplifiers continue that tradition, with power levels and features carefully chosen to perfectly integrate into fixed install design requirements.

Modern power amplifiers are sophisticated pieces of engineering capable of producing extremely high power levels. They must be treated with respect and correctly installed if they are to provide the many years of reliable service for which they were designed.

In addition, CTs Series amplifiers include a number of features which require some explanation before they can be used to their maximum advantage.

Please take the time to study this manual so that you can obtain the best possible service from your amplifier.

### 1.1 Features

- New Crown® Switching Power Supply for reduced weight.

- High power-density, with eight channels in a 3U chassis and four channels in a 2U chassis.
- Selectable constant-voltage (70V/100V) or low-impedance (8/4 ohm) operation for each channel pair.
- FIT (Fault Isolation Topology) circuitry isolates faults within affected channels.
- 35 Hz High-Pass Filter (70 Hz in CTs 4200) is automatically inserted when the channel pair is set for constant-voltage operation. (corner frequency may be changed as a service option).
- Accepts VC-MC accessory module that tailors the amplifier for remote VCA level control.
- Comprehensive array of indicators including Power and Data, along with Bridge, Ready, Signal, Clip, Thermal and Fault for each channel, provide accurate diagnostics.
- Blue Power Indicator flashes if the amplifier shuts off due to an under-/over-voltage condition on the AC mains.
- Advanced protection circuitry guards against: shorted outputs, open circuits, DC, mismatched loads, general overheating, under-/over-voltage, high-frequency overloads and internal faults.

- Proven Crown AB+B *Multi-Mode*® output topology.
- Continuously-variable-speed fans optimize cooling efficiency.
- Three Year, No-Fault, Fully-Transferable Warranty completely protects your investment and guarantees its specifications.

## 2 How to Use This Manual

This manual provides you with the necessary information to safely and correctly setup and operate your amplifier. It does not cover every aspect of installation, setup or operation that might occur under every condition. For additional information, please consult Crown's *Amplifier Application Guide* (available online at [www.crownaudio.com](http://www.crownaudio.com)), Crown Tech Support, your system installer or retailer.

We strongly recommend you read all instructions, warnings and cautions contained in this manual. Also, for your protection, please send in your warranty registration card today, or register online at [www.crownaudio.com](http://www.crownaudio.com). And save your bill of sale—it's your official proof of purchase.

### 3 Setup

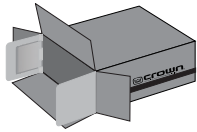

#### 3.1 Unpack Your Amplifier

Please unpack and inspect your amplifier for any damage that may have occurred during transit. If damage is found, notify the transportation company immediately. Only you can initiate a claim for shipping damage. Crown will be happy to help as needed. Save the shipping carton as evidence of damage for the shipper's inspection.

We also recommend that you save all packing materials so you will have them if you ever need to transport the unit. **Never ship the unit without the factory pack.**

YOU WILL NEED (not supplied):

- Input wiring cables
- Output wiring cables

Rack for mounting amplifier (or a stable surface for stacking)



**WARNING:** Before you start to set up your amplifier, make sure you read and observe the Important Safety Instructions found at the beginning of this manual.



#### 3.2 Install Your Amplifier

**CAUTION:** Before you begin, make sure your amplifier is disconnected from the power source, with the power switch in the "off" position and all level controls turned completely down (counterclockwise).

Use a standard 19-inch (48.3-cm) equipment rack (EIA RS-310B). See Figure 3.1 for amplifier dimensions.

You may also stack amps without using a cabinet.

NOTE: When transporting, amplifiers should be supported at both front and back.

#### 3.3 Ensure Proper Cooling

When using an equipment rack, mount units directly on top of each other. Close any open spaces in rack with blank panels. DO NOT block front, rear or side air vents. The side walls of the rack should be a minimum of two inches (5.1 cm) away from the amplifier sides, and the back of the rack should be a minimum of four inches (10.2 cm) from the amplifier back panel.

Figure 3.2 illustrates standard amplifier airflow.

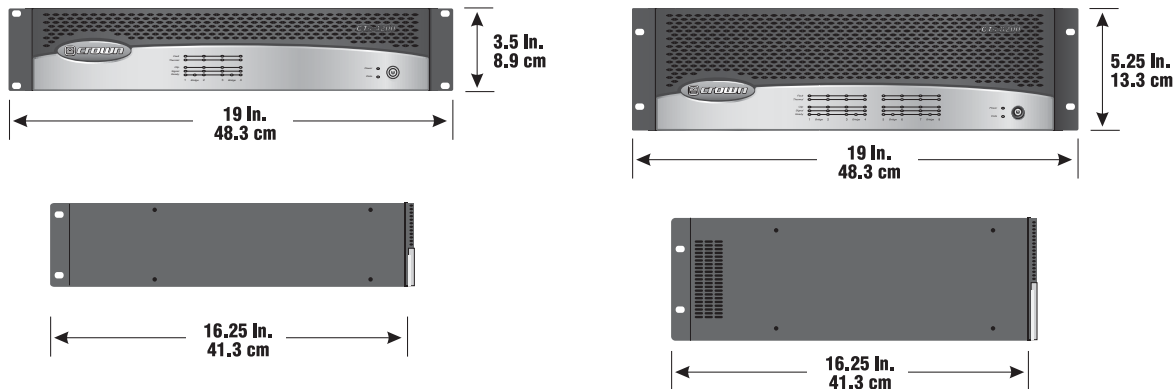

Figure 3.1 Dimensions  
Left: CTs 4200 Right: CTs 8200

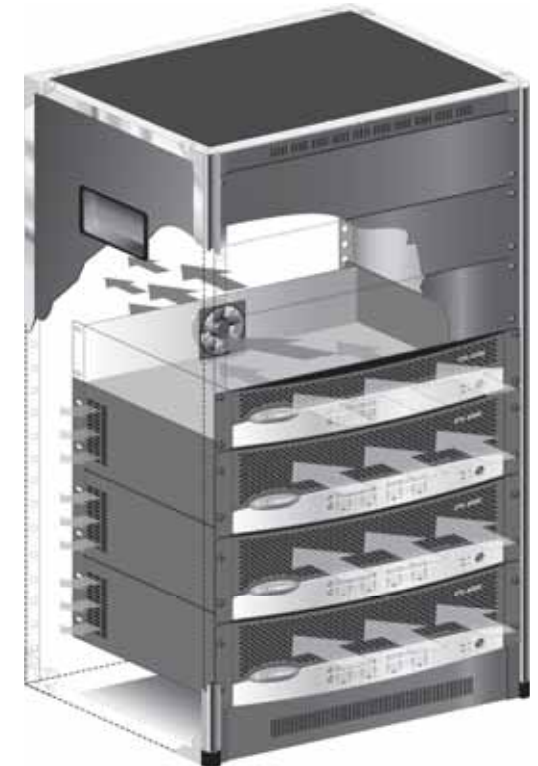

Figure 3.2 Airflow

### 3 Setup

#### 3.4 Choose Input Wire and Connectors

Figure 3.3 shows connector pin assignments for balanced wiring, and Figure 3.4 shows connector pin assignments for unbalanced wiring.

When possible, use balanced wiring for signal input, which provides better rejection of unwanted noise and hum. For more information, refer to the *Crown Amplifier Application Guide*, available online at [www.crownaudio.com](http://www.crownaudio.com)



**NOTE:** Custom wiring should only be performed by qualified personnel.

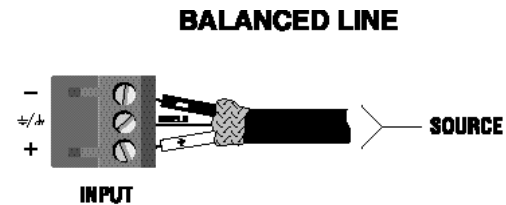

Figure 3.3 Balanced Input Connector Wiring

See the *Crown Amplifier Application Guide*, available online at [www.crownaudio.com](http://www.crownaudio.com), for pin assignments for

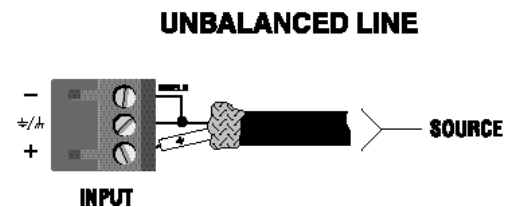

Figure 3.4 Unbalanced Input Connector Wiring

#### 3.5 Choose Output Wire and Connectors

Crown recommends using professionally constructed, high-quality, two- or four-conductor, heavy gauge speaker wire and connectors. You may use terminal forks or bare wire for your output connectors (see Figure 3.5). CTs amplifier terminal strips accept up to 10 AWG terminal forks which fit over a #8 screw. For best results, Crown recommends Panduit part #PV10-10LF-L or equivalent terminal fork. Screw spacing is shown in Figure 3.5.

To connect outputs, first remove the touch-proof cover plate covering the terminal strip by removing the screw which holds it in place.

To prevent the possibility of short-circuits, wrap or otherwise insulate exposed loudspeaker cable and connectors. Also, a touch-proof cover plate, which covers the terminal strips, is provided to help prevent short circuits. The cover plate should be reinstalled after connecting outputs.

Suggested below are guidelines to select the appropriate size of wire based on the distance from amplifier to speaker. Check with local code as this may vary.

Distance	Wire Size
up to 25 ft (7.6 m)	16 AWG
26-40 ft (7.9-12.2 m)	14 AWG
41-60 ft (12.5-18.3 m)	12 AWG
Over 60 ft (18.3 m)	10 AWG

**CAUTION:** Never connect the speaker return to the chassis of the amplifier, or damage to the amplifier may result.



**CAUTION:** Never use shielded cable for output wiring.

**NOTE:** CTs 8200 is shown. Some CTs 4200 features are in different locations.

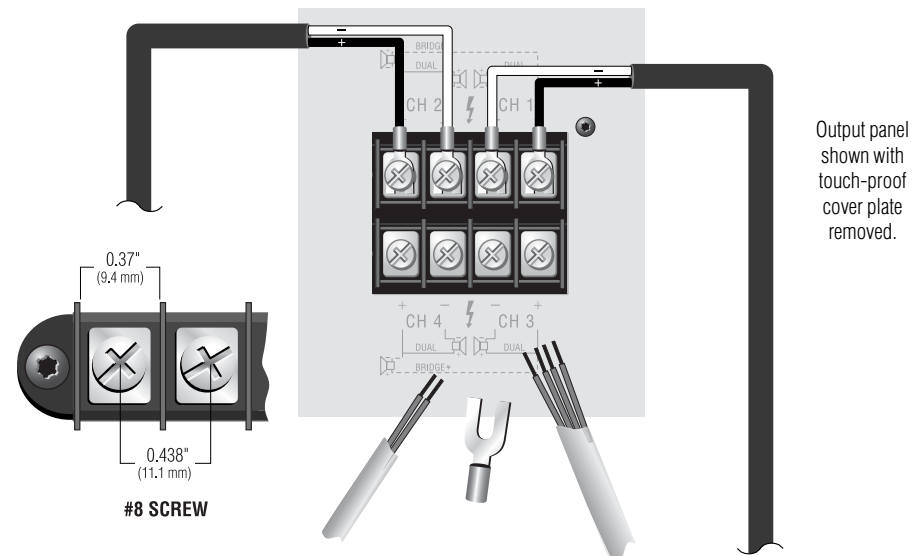

Figure 3.5 Output Connector Wiring (Typical of two channels)

### 3 Setup

#### 3.6 Wire Your System



**CAUTION: Never change the position of the Mode Switch while the amplifier power is on. See Section 5.2.2 for more information.**

##### 3.6.1 Dual 8/4 Mode

Typical input and output wiring, along with level control and Mode Switch settings are shown in Figure 3.6. Make sure the Mode switch is set to the "Dual 8/4" position.

**INPUTS:** Connect input wiring for each channel.

**OUTPUTS:** Maintain proper polarity (+/-) on output connectors.

Connect the Channel 1 speaker's positive (+) lead to amplifier Channel 1 positive terminal; repeat for negative (-). Repeat each channel wiring as for Channel 1. Refer to Section 3.5 for output connector pin assignments.

##### 3.6.2 Dual 70V Mode



**CAUTION: Never change the position of the Mode Switch while the amplifier power is on. See Section 5.2.2 for more information.**

Typical input and output wiring, along with level control and Mode Switch settings are shown in Figure 3.7. Make sure the Mode switch is set to the "Dual 70V" position.

**INPUTS:** Connect input wiring for each channel.

**OUTPUTS:** Maintain proper polarity (+/-) on output connectors.

Connect Channel 1 positive (+) speaker load to Channel 1 positive terminal of amp; repeat for negative (-). Repeat each channel wiring as for Channel 1. Refer to Section 3.5 for output connector pin assignments.

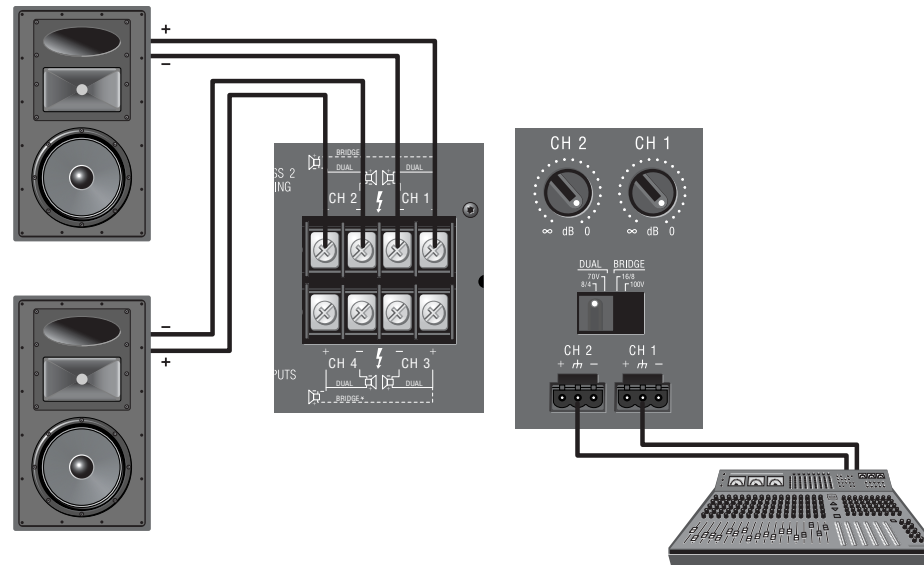

See the *Crown Amplifier Application Guide*, available online at [www.crownaudio.com](http://www.crownaudio.com), for pin assignments for commonly used connector types.

Output panel shown with touch-proof cover plate removed.

Figure 3.6 System Wiring and Control Settings, Dual Mode, 8/4 Ohm

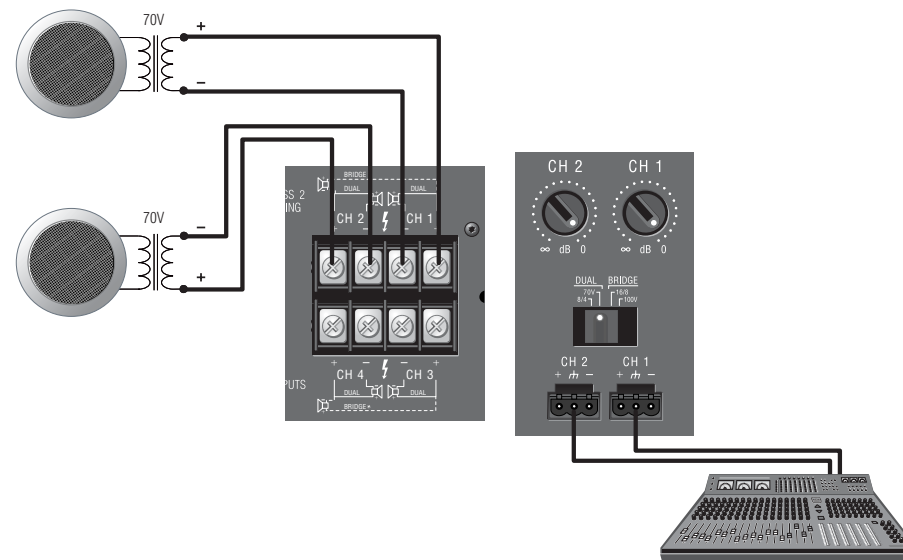

Output panel shown with touch-proof cover plate removed.

Figure 3.7 System Wiring and Control Settings, Dual Mode, 70V.

### 3 Setup



#### 3.6.3 Bridge-Mono 16/8 Mode

**CAUTION:** Never change the position of the Mode Switch while the amplifier power is on. See Section 5.2.2 for more information.

Typical input and output wiring, along with level control and Mode Switch settings are shown in Figure 3.8. Make sure the Mode switch is set to the "Bridge 16/8" position.

**INPUTS:** Connect input wiring only to the lower- (odd-) numbered channel pair.

**OUTPUTS:** Connect the speaker across the positive terminals of each channel pair. Do not use the negative terminals of the channel pair when the pair is being operated in Bridge-Mono mode.

**NOTE:** When operating the channel pair in Bridge-Mono mode, turn down (full CCW) the level control for the higher (even)-numbered channel of the channel pair. The lower (odd)-numbered level control works both channels.



#### 3.6.4 Bridge-Mono 100V Mode

**CAUTION:** Never change the position of the Mode Switch while the amplifier power is on. See Section 5.2.2 for more information.

Typical input and output wiring, along with level control and Mode Switch settings are shown in Figure 3.9. Make sure the Mode switch is set to the "Bridge 100V" position.

**INPUTS:** Connect input wiring only to the lower- (odd-) numbered channel pair.

**OUTPUTS:** Connect the speaker across the positive terminals of each channel pair. Do not use the negative terminals of the channel pair when the pair is being operated in Bridge-Mono mode.

**NOTE:** When operating the channel pair in Bridge-Mono mode, turn down (full CCW) the level control for the higher (even)-numbered channel of the channel pair. The lower (odd)-numbered level control works both channels.

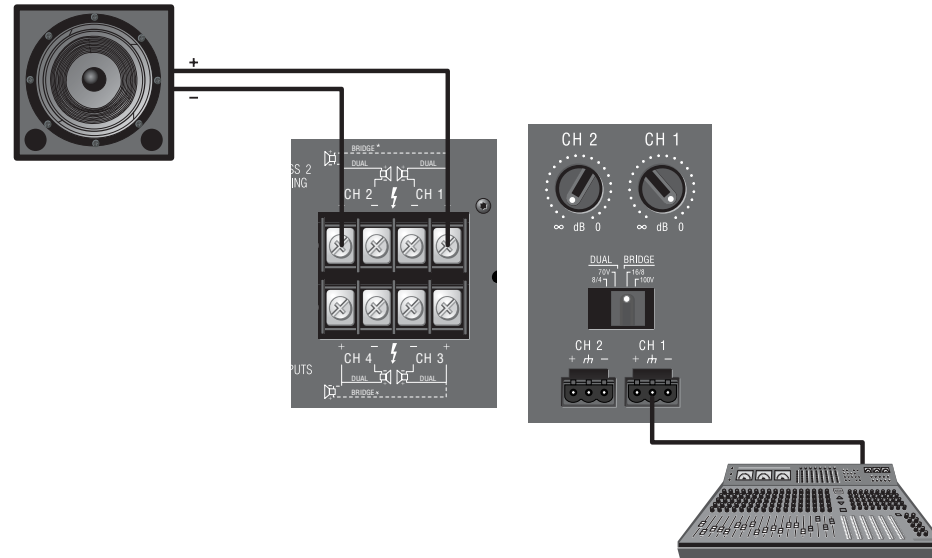

See the Crown Amplifier Application Guide, available online at [www.crownaudio.com](http://www.crownaudio.com), for pin assignments for commonly used connector types.

Figure 3.8 System Wiring and Control Settings, Bridge-Mono Mode, 16/8 Ohm.

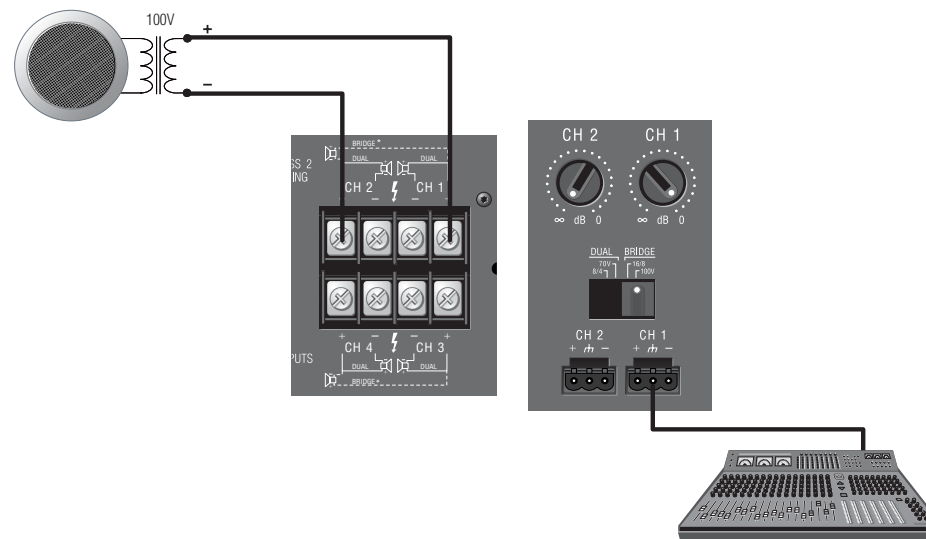

Figure 3.9 System Wiring and Control Settings, Bridge-Mono Mode, 100V

## 3 Setup

### 3.7 Connect to AC Mains

Connect your amplifier to the AC mains power source (power outlet) with the supplied AC power cordset. First, connect the IEC end of the cordset to the IEC connector on the amplifier; then, plug the other end of the cordset to the AC mains.



**WARNING: The third prong of this connector (ground) is an important safety feature. Do not attempt to disable this ground connection by using an adapter or other methods.**

Amplifiers don't create energy. The AC mains voltage and current must be sufficient to deliver the power you expect. If the AC line voltage varies out of an acceptable range, the amplifier's power supply turns off and the blue Power LED flashes. The amplifier will turn back on when the AC line voltage returns to safe operating levels. Figure 3.10 provides voltage limits for all amplifier AC voltage configurations. Also, the amplifier must be run within the specified mains frequency requirements (indicated on the amplifier's back panel label). If you are unsure of the output voltage of your AC mains, please consult your electrician.

Models	Under-Voltage Limit	Over-Voltage Limit
100VAC (CTs 8200 only)	90VAC	110VAC
120 VAC units	108VAC	132VAC
220V/230V/ 240V units	198VAC	264VAC

*Figure 3.10 AC Under-Voltage and Over-Voltage Limits for Various Amplifier Models*

### 3.8 Startup Procedure

Use the following procedure when first turning on your amplifier:

1. Turn down the level of your audio source.
2. Turn down the level controls of the amplifier.
3. Turn on the "Power" switch. The Power indicator should glow.
4. Turn up the level of your audio source to an optimum level.
5. Turn up the Level controls on the amplifier until the desired loudness or power level is achieved.
6. Turn down the level of your audio source to its normal range.

If you ever need to make any wiring or installation changes, don't forget to disconnect the power cord.

For help with determining your system's optimum gain structure (signal levels) please refer to the *Crown Amplifier Application Guide*, available online at [www.crownaudio.com](http://www.crownaudio.com).

## 4 Operation

### 4.1 Precautions

Your amplifier is protected from internal and external faults, but you should still take the following precautions for optimum performance and safety:

1. Before use, your amplifier first must be configured for proper operation, including input and output wiring hookup. Improper wiring can result in serious operating difficulties. For information on wiring and configuration, please consult the Setup section of this manual or, for advanced setup techniques, consult Crown's *Amplifier Application Guide* available online at [www.crownaudio.com](http://www.crownaudio.com).
2. Use care when making connections, selecting signal sources and controlling the output level. The load you save may be your own!
3. Do not short the ground lead of an output cable to the input signal ground. This may form a ground loop and cause oscillations.
4. **WARNING: Never connect the output to a power supply, battery or power main. Electrical shock may result.** 
5. Tampering with the circuitry, or making unauthorized circuit changes may be hazardous and invalidates all agency listings, and may also void the product's warranty.
6. Do not operate the amplifier with the red Clip LEDs constantly flashing.
7. Do not overdrive the mixer, which will cause clipped signal to be sent to the amplifier. Such signals will be reproduced with extreme accuracy, and loudspeaker damage may result.
8. Use caution when operating the amplifier with a 2-ohm load impedance on 1 channel. Do not operate the amplifier with less than a 2-ohm load impedance per channel when driving more than 1 channel. Due to the amplifier's output protection, such a configuration may result in premature clipping, speaker damage or a blown power fuse.

*Remember: Crown is not liable for damage that results from overdriving other system components.*

## 4 Operation

### 4.2 Front Panel Controls and Indicators

**Note: CTs 8200 is shown. Some CTs 4200 features are in different locations.**

#### A. Bridge Mode Indicator

Yellow LED, one per channel pair, illuminates when the channel pair's Mode Switch is set to the "Bridge" position. If Mode switch is changed while amplifier is powered up, Bridge LED will flash, indicating that the amplifier must be powered off and on to reset the Mode. See Section 6.9.

#### B. Ready Indicator

Green LED, one per channel, illuminates when the channel is initialized and ready to produce audio output.

#### C. Signal Indicator

Green LED, one per channel, illuminates to indicate the presence of input signals above  $-40$  dBu.

#### D. Clip Indicator

Red LED, one per channel, illuminates when the THD of the channel's output signal rises to a level typically considered as the onset of audible clipping. The Clip Indicator also will illuminate during Thermal Level Control (TLC) or input overload.

#### E. Thermal Indicator

Red LED, one per channel, flashes when the channel has shut down due to thermal stress or overload. If the power supply goes into thermal overload, all channel LEDs will flash.

#### F. Fault Indicator

Red LED, one per channel, illuminates when the amplifier output channel has stopped operating.

#### G. Ventilation Grille

Front-to-rear forced airflow.

#### H. Data Indicator

Yellow LED indicates IQ Loop data activity (if the amplifier is equipped with an IQ-MC module, and connected to an IQ Loop).

#### I. Power Indicator

Blue LED indicates amplifier has been turned on and AC power is available. Indicator also flashes if the amplifier shuts off due to an under/over-voltage condition on the AC mains.

#### J. Power Switch

Amplifier is on when the switch is in the IN position.

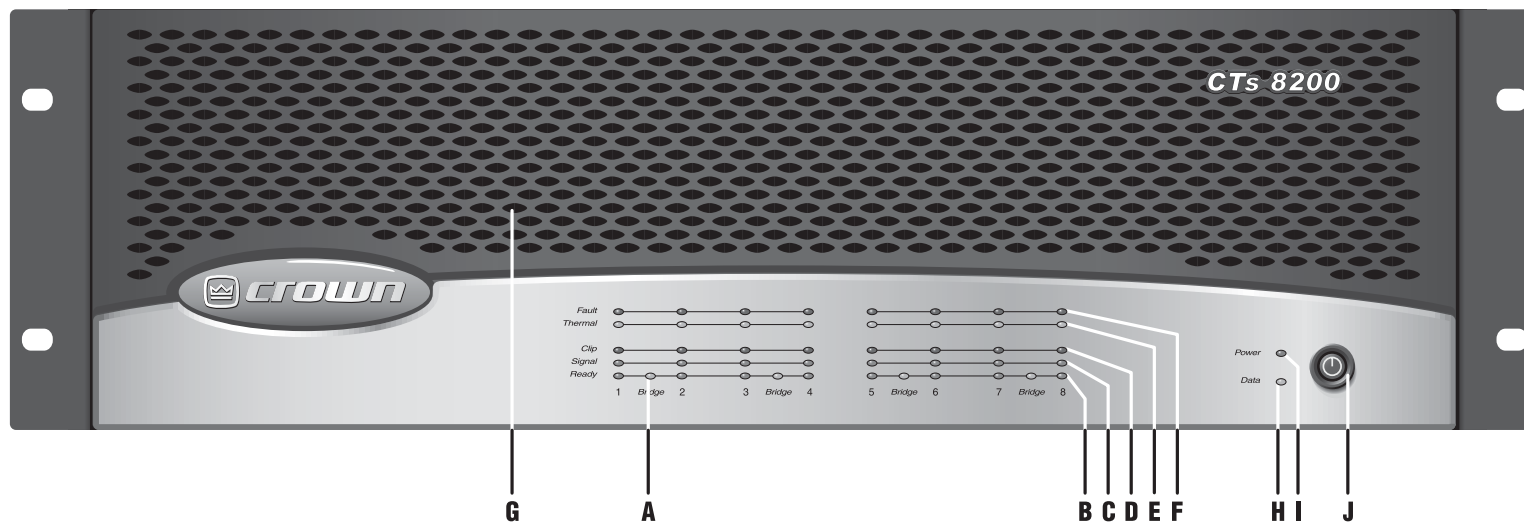

Figure 4.1 CTs 8200 front panel.



## 4 Operation

### 4.3 Back Panel Controls and Connectors

**Note: CTs 8200 is shown. Some CTs 4200 features are in different locations.**

#### K. AC Power Cord Connector

Standard IEC type 320 inlet.  
120V models: 15-amp.  
220-240V models: 10-amp.  
Voltage is indicated above IEC inlet.

#### L. Output Connectors

One four-pole terminal strip for every two channels with touch-proof cover. Accepts up to 10 AWG terminal forks. To connect outputs, first remove the touch-proof cover plate covering the terminal strip by removing the screw which holds it in place.

#### M. Accessory Panel

CTs 4200: Accepts an optional IQ-MC4A or VCA-MC4A module.

CTs 8200: Accepts an optional IQ-MC8 or VCA-MC8 module (explained in Section 5.3.1, Control Modules).

#### N. Channel Level Controls

One 21-position detented rotary potentiometer per channel, ranging from infinity (-70 dB) to 0 dB attenuation. Refer to Section 5.2.4 for precise dB attenuation increments for each detent.

#### O. Input Connectors

Removable Phoenix-style barrier connectors for balanced input.

#### P. Mode Switch

Used on each consecutive pair of channels, this four-position switch is used to select the amplifier's mode of operation: Dual 8/4 ohms, Dual 70V, Bridge-Mono 16/8 ohms, and Bridge-Mono 100V.



**IMPORTANT: Be sure to power off the amplifier before change the Mode-switch setting.** If this is not done, the Bridge light will flash to indicate that the power must be cycled off and back on to reset the mode.

#### Q. Cooling Vents

Front-to-rear forced airflow.

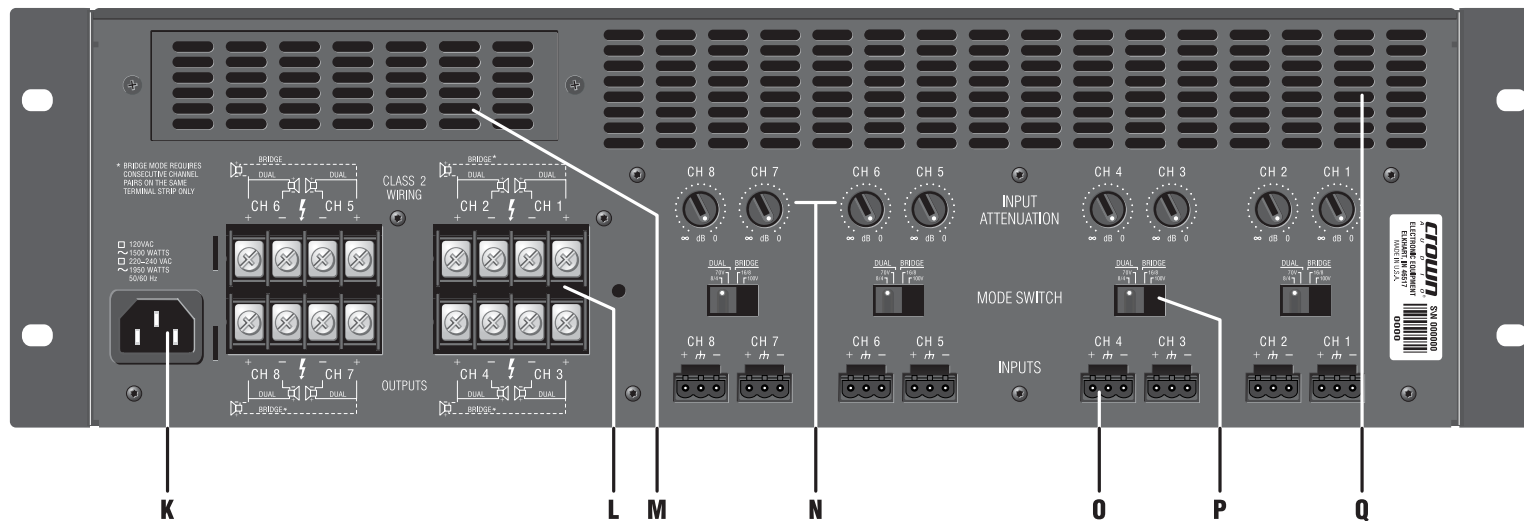

Figure 4.2 CTs 8200 back panel (shown with touch-proof cover removed).

## 5 Advanced Features and Options

**NOTE: For more information about these Crown amplifier features, please visit the Crown website at [www.crownaudio.com](http://www.crownaudio.com).**

### 5.1 Protection Systems

Your Crown amplifier provides extensive protection and diagnostic capabilities, including thermal level control, fault indicators, automatic high-pass filtering, DC protect, AC under-/over-voltage protection, inrush limiting, and variable-speed fans.

#### 5.1.1 Thermal Level Control (TLC)

If an amplifier channel starts to overheat, the TLC circuit will engage that channel's input compressor. By compressing the input, the amplifier will not generate as much heat and will have a chance to cool down. The degree of compression is proportional to the amount of overheating. If the channel becomes too hot for safe operation even after full TLC limiting, the channel will shut off, and the Thermal Indicator for that channel will flash brightly to alert the user that a state of thermal stress or overload has caused the channel to shut down.

#### 5.1.2 Fault

If an amplifier channel requires service, the corresponding Fault indicator will illuminate to alert the user of this condition. If this occurs, return the amplifier to the Crown factory or to an authorized Crown service center.

#### 5.1.3 Fault Isolation Topology (FIT)

Crown's new FIT (Fault Isolation Topology) design isolates channel-specific faults, and prevents them from affecting remaining channels. If a CTs multi-channel amp is powering multiple zones, and a channel fails, the other zones continue to operate. FIT makes the CTs 4200 and CTs 8200 the most trustworthy multi-channel amplifiers in the business!

#### 5.1.4 35-Hz High-Pass Filter

A fixed 35-Hz (70-Hz in CTs 4200) high-pass filter per channel pair is automatically inserted when the mode switch is set to either of the constant-voltage settings. The high-pass filter corner frequency can be set to 70 Hz, or bypassed, with a service option.

#### 5.1.5 AC Under-/Over-Voltage Protection

If the AC line voltage varies out of an acceptable range, the amplifier's power supply turns off and the blue Power LED flashes. The amplifier will turn back on when the AC line voltage returns to safe operating levels. Figure 5.1 provides voltage limits for all amplifier AC voltage configurations. Also, the amplifier must be run within the specified mains frequency requirements (indicated on the amplifier's back panel label). If you are unsure of the output voltage of your AC mains, consult your electrician.

Models	Under-Voltage Limit	Over-Voltage Limit
100VAC (CTs 8200 only)	90VAC	110VAC
120 VAC units	108VAC	132VAC
220V/230V/ 240V units	198VAC	264VAC

*Figure 5.1 AC Under-Voltage and Over-Voltage Limits for Various Amplifier Models*

#### 5.1.6 Power Fuse

A fuse protects the amplifier from excessive AC current draw.

#### 5.1.7 Inrush Limiting

A soft-start circuit in the power supply minimizes the amplifier's current draw during power-on.

#### 5.1.8 Variable-speed Fans

Continuously variable speed fans direct the airflow through the amplifier for cooling.

### 5.2 Advanced Features

#### 5.2.1 Switching Power Supply

Crown's new Switching Power Supply minimizes the amplifier's weight.

Typical non-switching power supplies require large, heavy transformers in order to produce the required power at the output stage. These transformers must be large to absorb the substantial waste that occurs when operating at 50 to 60 Hz (standard AC supplied by the power company).

By contrast, switching power supplies can operate with a much smaller (and lighter) transformer because they first convert the AC up to a much higher frequency, thereby reducing waste.

The power supply is voltage-specific, allowing use in regions using 120V/60Hz, 220V/50Hz, 230V/50Hz, 240V/50Hz, and 100V/50Hz AC mains.

#### 5.2.2 Mode Switch

Each consecutive pair of channels has one four-position switch that selects the amplifier's mode of operation. The switch positions are:

- Dual mode for 4 or 8 ohm operation.
- Dual mode for 70V constant-voltage operation.
- Bridge-Mono mode for 8 or 16 ohm operation.
- Bridge-Mono mode for 100V constant-voltage operation.



**Be sure to turn off the amplifier before changing the Mode-switch setting.**

#### 5.2.3 Bridge Mode Indicator

This yellow LED indicates when the amplifier's mode switch is set to the Bridge position. Each consecutive pair of channels has one Bridge LED.

## 5 Advanced Features and Options

### 5.2.4 Channel Level Control

The signal level for each input can be attenuated accurately by adjusting the 21-step Level Control (see Section 4.2). Figure 5.2 shows the amount of attenuation in dB for each detent.

Note: Attenuation per detent varies with operating mode since gain varies with operating mode. Attenuation amounts shown may vary  $\pm 6\%$ .

ATTENUATION in dB

Detent	4/8 Ohm	70V	100V
0 (full CCW)	68.31	72.90	71.02
1	67.54	72.06	70.26
2	32.23	36.61	34.90
3	25.46	29.74	28.00
4	21.83	25.87	24.22
5	19.23	23.20	21.58
6	17.12	20.94	19.40
7	15.36	19.02	17.53
8	13.76	17.22	15.79
9	12.28	15.53	14.20
10	10.84	13.90	12.62
11	9.51	12.32	11.16
12	8.28	10.87	9.81
13	7.09	9.45	8.45
14	6.30	8.11	7.22
15	4.92	6.70	5.94
16	3.82	5.26	4.63
17	2.62	3.70	3.21
18	1.35	1.90	1.66
19	0.01	0.01	0.01
20 (full CW)	0.00	0.00	0.00

Figure 5.2 Level-control Attenuation per Detent in CTs Multichannel Amplifiers

## 5 Advanced Features and Options

### 5.3 Options

Below are some available options. For current options, visit the Crown website at [www.crownaudio.com](http://www.crownaudio.com).

#### 5.3.1 Control Modules

**VCA-MC (VCA module):** See Figure 5.3. Provides independent remote level control for each channel. 4-pin removable Phoenix-style barrier connectors provide the +10VDC control voltage, ground, and control lines for two amplifier channels. Thus, 4-channel amplifiers use two connectors; 8-channel amplifiers use four connectors.

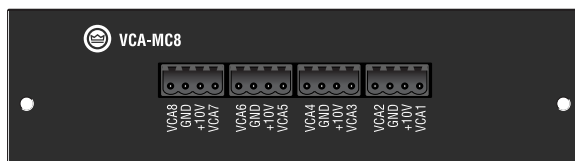

Figure 5.3 VCA-MC8 Module

#### Choosing the Right Module

To order accessory modules for your amplifier, please refer to the model tag (located on the back panel of the amplifier) for your amplifier's specific model number. Then refer to the chart below to select the correct accessory for your requirements.

	VCA MODULE
CTs 4200	VCA-MC4
CTs 4200A	VCA-MC4A
CTs 8200	VCA-MC8
CTs 8200A	VCA-MC8

#### Wall-Mount level control panels for use with VCA module:

**1-VCAP:** See Figure 5.4. Used in conjunction with a VCA-MC module, this is a single-gang panel providing remote volume control for one or more CTs amplifier channels. The potentiometer on the panel is wired directly to one of the VCA connectors on the VCA-MC.

**4-VCAP:** See Figure 5.5. This is a two-gang panel providing remote volume control for four or more CTs amplifier channels. The potentiometers on the panel are wired directly to the respective VCA connector on the VCA-MC.

Refer to the VCA-MC Operation Manual for wiring of the single or multiple channel level control.

Your amplifier may have come with a VCA-MC module already factory-installed, or your choice of MC modules can be easily added to the amplifier by any authorized Crown Service Center. Contact Crown Technical Support for more details.

#### 5.3.2 Input Sensitivity

The CTs 4200 and CTs 8200 have a fixed input sensitivity of 1.4V. A service option is available for other input sensitivities.

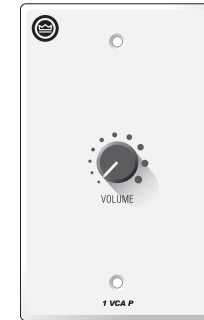

Figure 5.4 1-VCAP Module



Figure 5.5 4-VCAP Module

## 6 Troubleshooting

Fault	●	—		
Thermal	●	—		
Clip	●	—	Power	●
Signal	●	—		
Ready	●	—	Data	●
	1	Bridge		

**CONDITION: Power indicator is off.**

**POSSIBLE REASON**

- The amplifier has lost AC power.
- The amplifier's Power switch is off.
- The amplifier is not plugged into the power receptacle.
- The amplifier output level is so high that the power supply fuse has blown. Verify that input levels and output impedances are within safe ranges. Refer the unit to an authorized Crown service center for fuse replacement.

Fault	☀	—		
Thermal	●	—		
Clip	●	—	Power	☀
Signal	●	—		
Ready	●	—	Data	●
	1	Bridge		

**CONDITION: Fault indicator is on.**

**POSSIBLE REASON:**

- The amplifier channel has stopped operating. Return the unit to an authorized Crown Service Center.

Fault	●	—		
Thermal	●	—		
Clip	●	—	Power	☀
Signal	●	—		
Ready	●	—	Data	●
	1	Bridge		

**CONDITION: Power indicator is flashing.**

**POSSIBLE REASON:**

- The AC line voltage has dropped below 10% or has risen above 10% of the nominal line voltage of the power supply.

Refer to section 5.1.6 for specific voltage requirements.

Fault	●	—		
Thermal	●	—		
Clip	☀	—	Power	☀
Signal	☀	—		
Ready	☀	—	Data	●
	1	Bridge		

**CONDITION: Distorted sound.**



**POSSIBLE REASON:**

- Load is wired incorrectly or Dual/Bridge mode switch is set incorrectly. Check both.
- Input is overloaded by a signal level that is too high. Turn down your amplifier level controls, or turn down the input signal, until the clip light goes out.
- Thermal Level Control (TLC) is active.

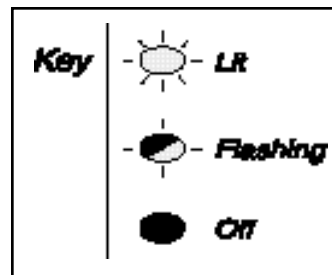
Note: If the signal sounds distorted even though the Clip LED is off, the input signal is distorted. Check gain staging and output levels of the mixer or preamp.



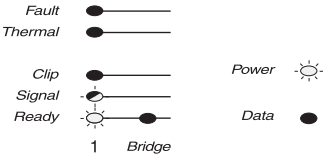
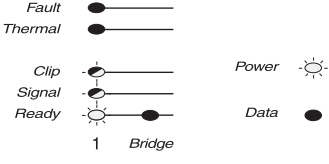

## 6 Troubleshooting

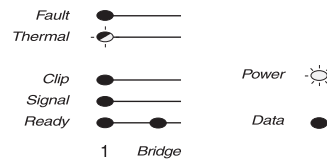
	<p><b>CONDITION: No sound, even though the amp has power.</b> Power LED is on without flashing and the amp is receiving an input signal. Signal indicator is flashing.</p> <ul style="list-style-type: none"> <li>Speakers not connected.</li> <li>Open circuit due to speaker failure.</li> </ul>
	<ul style="list-style-type: none"> <li>There is a short on the amplifier output. First disconnect your speakers from the affected channel(s) one by one to determine if one of the loads is shorted.</li> </ul>
	<ul style="list-style-type: none"> <li>DC or excessive low-frequency signal at the amplifier's output has enabled speaker protection.</li> </ul>

	<p><b>CONDITION: Thermal indicator is flashing.</b></p> <p><b>POSSIBLE REASON:</b></p> <ul style="list-style-type: none"> <li>The amplifier has become too hot for safe operation. Check for loads less than 2 ohms, and for excessive input levels. Check for proper ventilation and proper mode-switch setting. Driving low-impedance loads while in high-voltage mode can cause overheating.</li> </ul>
---	--

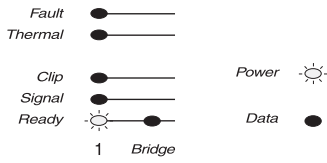
	<p><b>CONDITION: All channel thermal indicators are flashing.</b></p> <p><b>POSSIBLE REASON:</b></p> <ul style="list-style-type: none"> <li>Power supply thermal overload.</li> </ul>
---	---

	<p><b>CONDITION: No input signal.</b> (Signal indicator is not flashing even though audio is applied and channel is ready).</p> <p><b>POSSIBLE REASON:</b></p> <ul style="list-style-type: none"> <li>Input signal level is very low.</li> <li>Input cables have become disconnected.</li> </ul>
---	--

	<p><b>CONDITION: Bridge LED is flashing.</b></p> <p><b>POSSIBLE REASON:</b></p> <ul style="list-style-type: none"> <li>The mode switch was switched while the power was on.</li> </ul>
---	--

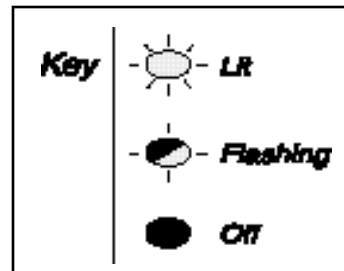

## 7 Specifications

Figure 7.1 CTs 4200 Power Chart

CTs 4200: MINIMUM GUARANTEED POWER (in watts, 0.1% THD) 120VAC, 60 Hz units					
Dual Mode					
Channels Driven	4		2	1	
	1 kHz	20 Hz - 20 kHz	1 kHz	1 kHz	20 Hz - 20 kHz
4 Ohm	260	215	270	270	225
8 Ohm	180	190	210	220	210
70V (25 Ohm) at 0.1% THD	220	220*	240	250	245*
Bridge-Mono Mode					
Channel Pairs Driven	2		1		
	1 kHz	20 Hz - 20 kHz	1 kHz	20 Hz - 20 kHz	
8 Ohm	520	430	560	450	
16 Ohm	400	380	440	420	
100V (50 Ohm) at 0.1% THD	220	220*	250	245*	

\* Constant Voltage full bandwidth power ratings support 100 Hz - 20 kHz due to automatic high-pass filters.

Figure 7.2 CTs 8200 Power Chart

CTs 8200: MINIMUM GUARANTEED POWER (In watts, 0.1% THD) 120VAC, 60 Hz units						
Dual Mode						
Channels Driven	8		4	2	1	
	1 kHz	20 Hz - 20 kHz	1 kHz	1 kHz	1 kHz	20 Hz - 20 kHz
4 Ohm	200	175	250	260	270	230
8 Ohm	160	155	190	200	220	220
70V (25 Ohm) at 0.1% THD	200	185*	220	240	250	230*
Bridge-Mono Mode						
Channel Pairs Driven	4		2	1		
	1 kHz	20 Hz - 20 kHz	1 kHz	1 kHz	20 Hz - 20 kHz	
8 Ohm	400	350	500	540	460	
16 Ohm	320	310	380	440	440	
100V (50 Ohm) at 0.1% THD	200	185*	220	250	230*	

\* Constant Voltage full bandwidth power ratings support 100 Hz - 20 kHz due to automatic high-pass filters.

## 7 Specifications

The following specifications apply to all models in Dual 8/4 ohm mode with 8-ohm loads unless otherwise specified.

Performance	CTs 4200	CTs 8200
Frequency Response (at 1 watt, 20 Hz - 20 kHz)	± 0.5 dB	± 0.5 dB
Phase Response (at 1 watt, 10 Hz - 20 kHz)	± 35°	± 35°
Signal to Noise Ratio below rated power (20 Hz to 20 kHz)	100 dB unweighted	100 dB unweighted
Total Harmonic Distortion (THD) at 1 watt, from 20 Hz to 20 kHz	< 0.05%	< 0.05%
Intermodulation Distortion (IMD) 60 Hz and 7 kHz at 4:1, from 163 milliwatts to full bandwidth power, typical	< 0.05%	< 0.05%
Damping Factor: 10 Hz to 400 Hz	>180	>180
Crosstalk (below rated power, 20 Hz to 1 kHz)	> 80 dB	> 80 dB
Common Mode Rejection (CMR) (20 Hz to 1 kHz)	> 50 dB	> 50 dB
DC Output Offset (Shorted input)	< ± 5 mV	< ± 5 mV
Input Impedance nominally balanced, nominally unbalanced	20 kilohms, 10 kilohms	20 kilohms, 10 kilohms
Maximum Input Level (before input compression)	+ 20 dBu	+ 20 dBu
Load Impedance (Note: Safe with all types of loads)		
Stereo	4/8 and 25 ohms (70V)	4/8 and 25 ohms (70V)
Bridge Mono	8/16 and 50 ohms (100V)	8/16 and 50 ohms(100V)
Voltage Gain (at maximum level setting), 1.4V sensitivity		
4/8 Ohm Operation	20:1 (26 dB)	20:1 (26 dB)
70V Operation	50:1 (34 dB)	50:1 (34 dB)
100V Operation	71.4:1 (37 dB)	71.4:1 (37 dB)
Required AC Mains (model dependent)	120V, 60 Hz. 220/230/240V, 50 Hz	100V, 50/60Hz. 120V, 60 Hz. 220/230/240V, 50 Hz
Power Draw at Idle (120VAC mains, all channels in 4/8 ohm mode)	70W	70W
Power Draw at Idle (120VAC mains, all channels in 70V mode)	114W	114W
Cooling	Continuously variable speed forced air, front-to-back airflow	Continuously variable speed forced air, front-to-back airflow
Dimensions: Width, Height, Depth	19 in. (48.3 cm) W x 3.5 in. (8.9 cm) H x 16.25 in. (41.3 cm) D	19 in. (48.3 cm) W x 5.25 in. (13.3 cm) H x 16.25 in. (41.3 cm) D
Net Weight, Shipping Weight	26 lb. 6 oz. (12 kg), 30 lb. 14 oz. (14 kg)	36 lb. 6 oz. (16.5 kg), 47 lb. (21.3 kg)



## 7 Specifications

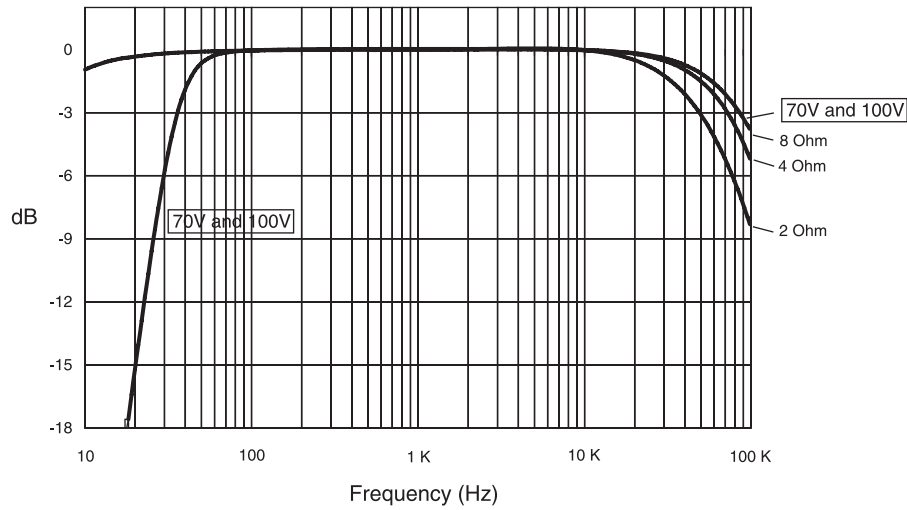

Figure 7.3 CTs 8200 Typical Frequency Response (1 W)

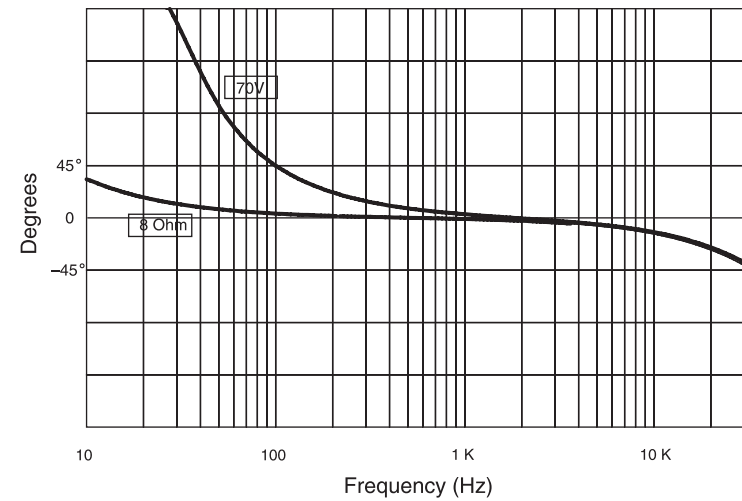

Figure 7.4 CTs 8200 Typical Phase Response (1 W)

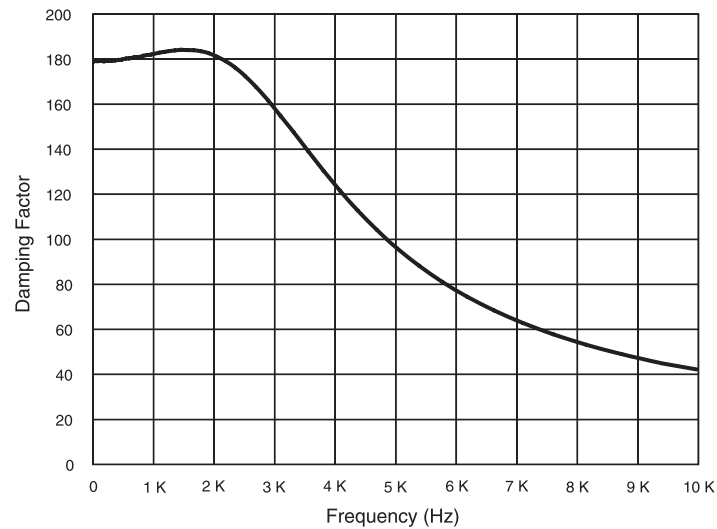

Figure 7.5 CTs 8200 Typical Damping Factor vs. Frequency

## 7 Specifications

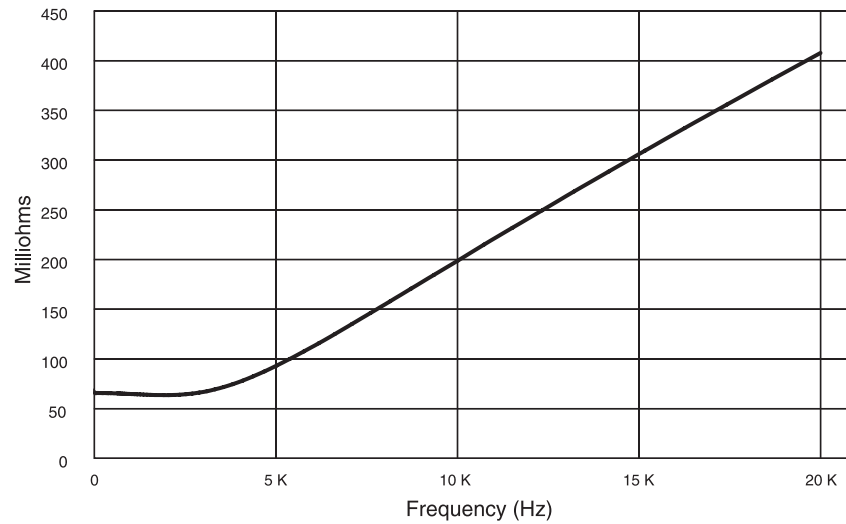

Figure 7.6 CTs 8200 Typical Output Impedance vs. Frequency

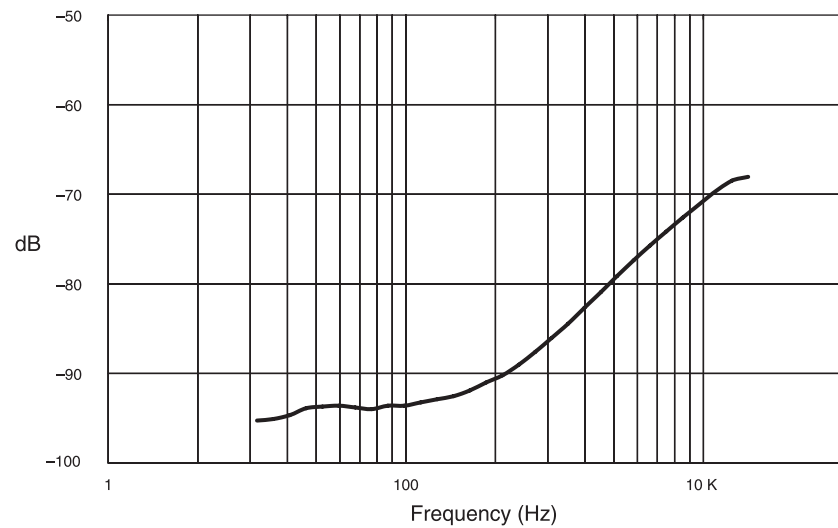

Figure 7.7 CTs 8200 Typical Crosstalk vs. Frequency

## 8 AC Power Draw and Thermal Dissipation

### AC Power Draw and Thermal Dissipation:

Pink noise 12dB crest factor, bandwidth limited 22Hz to 22kHz.

Typical line impedance used.

Measurements made with 120VAC mains. Line current figures for 230VAC units derived by multiplying 120VAC figures by 0.5.

Data based on all channels driven.

CTs 4200									
	Load	Rated Power	Line Current 120VAC	Line Current 230VAC	Watts			Thermal Dissipation	
					watts in	watts out	dissipated	Btu/hr	kcal/hr
At Idle (8.4 Ohm mode )					70	0	70	239	60
At Idle (70/100V mode)					114	0	114	389	98
1/8th Power Pink Noise Typical of program material just at clip.	8 Ohms/Ch. 16 Ohms Bridge	200x4 400x2	5.2	2.6	400	99	301	1027	259
	4 Ohms/Ch. 8 Ohms Bridge	260x4 520x2							
	70V/Ch. 100V Bridge	220x4	5.3	2.7	427	110	318	1084	273
		220x2							
1/3rd Power Pink Noise Typical of program material with severe clipping.	8 Ohms/Ch. 16 Ohms Bridge	200x4 400x2	7.6	3.8	648	257	391	1336	337
	4 Ohms/Ch. 8 Ohms Bridge	260x4 520x2							
	70V/Ch. 100V Bridge	220x4	7.9	4.0	668	286	382	1303	329
		220x2							

## 8 AC Power Draw and Thermal Dissipation

### AC Power Draw and Thermal Dissipation:

Pink noise 12dB crest factor, bandwidth limited 22Hz to 22kHz.

Typical line impedance used.

Measurements made with 120VAC mains. Line current figures for 230VAC units derived by multiplying 120VAC figures by 0.5.

Data based on all channels driven.

CTs 8200									
	Load	Rated Power	Line Current 120VAC	Line Current 230VAC	Watts			Thermal Dissipation	
					watts in	watts out	dissipated	Btu/hr	kcal/hr
At Idle (8.4 Ohm mode )					70	0	70	239	60
At Idle (70/100V mode)					114	0	114	389	98
1/8th Power Pink Noise Typical of program material just at clip.	8 Ohms/Ch. 16 Ohms Bridge	160x8 320x4	8.7	4.3	725	172	553	1889	476
	4 Ohms/Ch. 8 Ohms Bridge	200x8 400x4							
	70V/Ch. 100V Bridge	200x8	10.1	5.1	857	203	653	2230	562
		200x4							
1/3rd Power Pink Noise Typical of program material with severe clipping.	8 Ohms/Ch. 16 Ohms Bridge	160x8 320x4	13.1	6.5	1136	437	699	2385	601
	4 Ohms/Ch. 8 Ohms Bridge	200x8 400x4							
	70V/Ch. 100V Bridge	200x8	15.3	7.7	1344	552	792	2702	681
		200x4							

## 9 Service

Crown amplifiers are quality units that rarely require servicing. Before returning your unit for service, please contact Crown Technical Support to verify the need for servicing.

This unit has very sophisticated circuitry which should only be serviced by a fully trained technician. This is one reason why each unit bears the following label:

**CAUTION: To prevent electric shock, do not remove covers. No user serviceable parts inside. Refer servicing to a qualified technician.**



Complete the Crown Audio Factory Service Information form, in the back of this manual, when returning a Crown product to the factory or authorized service center. The form must be included with your product inside the box or in a packing slip envelope securely attached to the outside of the shipping carton. Do not send this form separately.

*Warranty is only valid within the country in which the product is purchased.*

### 9.1 International and Canada Service

Service may be obtained from an authorized service center. (Contact your local Crown/Amcron representative or our office for a list of authorized service centers.) To obtain service, simply present the bill of sale as proof of purchase along with the defective unit to an authorized service center. They will handle the necessary paperwork and repair.

Remember to transport your unit in the original factory pack.

### 9.2 US Service

Service may be obtained in one of two ways: from an authorized service center or from the factory. You may choose either. It is important that you have your copy of the bill of sale as your proof of purchase.

#### 9.2.1 Service at a US Service Center

This method usually saves the most time and effort. Simply present your bill of sale along with the defective unit to an authorized service center to obtain service. They will handle the necessary paperwork and repair. Remember to transport the unit in the original factory pack. A list of authorized service centers in your area can

be obtained from Crown Factory Service, or online from <http://www.crownaudio.com/support/servcent.htm>.

#### 9.2.2 Factory Service

Crown accepts no responsibility for non-serviceable product that is sent to us for factory repair. It is the owner's responsibility to ensure that their product is serviceable prior to sending it to the factory. Serviceable product list is available at

<http://crownweb.crownintl.com/crownrma/>.  
For more information, please contact us direct.

A Service Return Authorization (SRA) is required for product being sent to the factory for repair. An SRA can be completed online at [www.crownaudio.com/support/factserv.htm](http://www.crownaudio.com/support/factserv.htm). If you do not have access to the web, please call Crown's Customer Service at 574.294.8200 or 800.342.6939 extension 8205.

For warranty service, we will pay for ground shipping both ways in the United States. Contact Crown Customer Service to obtain prepaid shipping labels prior to sending the unit. Or, if you prefer, you may prepay the cost of shipping, and Crown will reimburse you. Send copies of the shipping receipts to Crown to receive reimbursement. Your repaired unit will be returned via UPS ground. Please contact us if other arrangements are required.

#### 9.2.3 Factory Service Shipping Instructions:

1. Service Return Authorization (SRA) is required for product being sent to the factory for service. Please complete the SRA by going to [www.crownaudio.com/support/factserv.htm](http://www.crownaudio.com/support/factserv.htm). If you do not have access to our website, call 1.800.342.6939, extension 8205 and we'll create the SRA for you.
2. See packing instructions that follow.
3. Ship product to:  
CROWN AUDIO FACTORY SERVICE  
1718 W MISHAWKA RD.  
ELKHART, IN 46517
4. Use a bold black marker and write the SRA number on three sides of the box.

5. Record the SRA number for future reference. The SRA number can be used to check the repair status.

#### 9.2.4 Packing Instructions

**Important:** These instructions must be followed. If they are not followed, Crown Audio, Inc. assumes no responsibility for damaged goods and/or accessories that are sent with your unit.

1. Fill out and include the Crown Audio Factory Service Information sheet in the back of this manual.
  2. Do not ship any accessories (manuals, cords, hardware, etc.) with your unit. These items are not needed to service your product. We will not be responsible for these items.
  3. When shipping your Crown product, it is important that it has adequate protection. We recommend you use the original pack material when returning the product for repair. If you do not have the original box, please call Crown at 800.342.6939 or 574.294.8210 and order new pack material. See instructions for "foam-in-place" shipping pack. (Do not ship your unit in a wood or metal cabinet.)
  4. If you provide your own shipping pack, the minimum recommended requirements for materials are as follows:
    - a. 275 P.S.I. burst test, Double-Wall carton that allows for 2-inch solid Styrofoam on all six sides of unit or 3 inches of plastic bubble wrap on all six sides of unit.
    - b. Securely seal the package with an adequate carton sealing tape.
    - c. Do not use light boxes or "peanuts". Damage caused by poor packaging will not be covered under warranty.
- Using your 'foam-in-place' shipping pack**
- Note: The foam-in-place packing is molded so that there is only one correct position for your product.
1. Open carton and lift center cushion leaving both end-cushions in place.

2. Carefully place your product with the product's front panel facing the same direction as arrows indicate.
3. Reset center cushion down over top of product's chassis. The foam-in-place packing was molded to accommodate different chassis depth sizes. If your product's chassis does not completely fill the foam-in-place cavity, you may use a soft but solid packing material (such as paper or bubble wrap) behind the chassis.
4. Enclose the completed Crown Audio Factory Service Information form (or securely attach it to the outside of carton) and re-seal the shipping pack with a sturdy carton sealing tape.

#### 9.2.5 Estimate Approval

Approval of estimate must be given within 30 days after being notified by Crown Audio Inc. Units still in the possession of Crown after 30 days of the estimate will become the property of Crown Audio Inc.

#### 9.2.6 Payment of Non-Warranty Repairs

Payment on out-of-warranty repairs must be received within 30 days of the repair date. Units unclaimed after 30 days become the property of Crown Audio Inc.

If you have any questions, please contact Crown Factory Service.

**Crown Factory Service**  
1718 W. Mishawaka Rd.,  
Elkhart, Indiana 46517 U.S.A.

**Telephone:**  
574.294.8200

800.342.6939 (North America,  
Puerto Rico, and Virgin Islands only)

**Facsimile:**  
574.294.8301 (Technical Support)  
574.294.8124 (Factory Service)

**Internet:**  
<http://www.crownaudio.com>

## 10 Warranty



### SUMMARY OF WARRANTY

Crown International, 1718 West Mishawaka Road, Elkhart, Indiana 46517-4095 U.S.A. warrants to you, the ORIGINAL PURCHASER and ANY SUBSEQUENT OWNER of each NEW Crown product, for a period of three (3) years from the date of purchase by the original purchaser (the "warranty period") that the new Crown product is free of defects in materials and workmanship. We further warrant the new Crown product regardless of the reason for failure, except as excluded in this Warranty.

*Warranty is only valid within the country in which the product was purchased.*

### ITEMS EXCLUDED FROM THIS CROWN WARRANTY

This Crown Warranty is in effect only for failure of a new Crown product which occurred within the Warranty Period. It does not cover any product which has been damaged because of any intentional misuse, accident, negligence, or loss which is covered under any of your insurance contracts. This Crown Warranty also does not extend to the new Crown product if the serial number has been defaced, altered, or removed.

### WHAT THE WARRANTOR WILL DO

We will remedy any defect, regardless of the reason for failure (except as excluded), by repair, replacement, or refund. We may not elect refund unless you agree, or unless we are unable to provide replacement, and repair is not practical or cannot be timely made. If a refund is elected, then you must make the defective or malfunctioning product available to us free and clear of all liens or other encumbrances. The refund will be equal to

## UNITED STATES & CANADA

the actual purchase price, not including interest, insurance, closing costs, and other finance charges less a reasonable depreciation on the product from the date of original purchase. Warranty work can only be performed at our authorized service centers or at the factory. Warranty work for some products can only be performed at our factory. We will remedy the defect and ship the product from the service center or our factory within a reasonable time after receipt of the defective product at our authorized service center or our factory. All expenses in remedying the defect, including surface shipping costs in the United States, will be borne by us. (You must bear the expense of shipping the product between any foreign country and the port of entry in the United States including the return shipment, and all taxes, duties, and other customs fees for such foreign shipments.)

### HOW TO OBTAIN WARRANTY SERVICE

You must notify us of your need for warranty service within the warranty period. All components must be shipped in a factory pack, which, if needed, may be obtained from us free of charge. Corrective action will be taken within a reasonable time of the date of receipt of the defective product by us or our authorized service center. If the repairs made by us or our authorized service center are not satisfactory, notify us or our authorized service center immediately.

### DISCLAIMER OF CONSEQUENTIAL AND INCIDENTAL DAMAGES

YOU ARE NOT ENTITLED TO RECOVER FROM US ANY INCIDENTAL DAMAGES RESULTING FROM ANY DEFECT IN THE NEW CROWN PRODUCT.

THIS INCLUDES ANY DAMAGE TO ANOTHER PRODUCT OR PRODUCTS RESULTING FROM SUCH A DEFECT. SOME STATES DO NOT ALLOW THE EXCLUSION OR LIMITATIONS OF INCIDENTAL OR CONSEQUENTIAL DAMAGES, SO THE ABOVE LIMITATION OR EXCLUSION MAY NOT APPLY TO YOU.

### WARRANTY ALTERATIONS

No person has the authority to enlarge, amend, or modify this Crown Warranty. This Crown Warranty is not extended by the length of time which you are deprived of the use of the new Crown product. Repairs and replacement parts provided under the terms of this Crown Warranty shall carry only the unexpired portion of this Crown Warranty.

### DESIGN CHANGES

We reserve the right to change the design of any product from time to time without notice and with no obligation to make corresponding changes in products previously manufactured.

### LEGAL REMEDIES OF PURCHASER

THIS CROWN WARRANTY GIVES YOU SPECIFIC LEGAL RIGHTS, YOU MAY ALSO HAVE OTHER RIGHTS WHICH VARY FROM STATE TO STATE. No action to enforce this Crown Warranty shall be commenced after expiration of the warranty period.

THIS STATEMENT OF WARRANTY SUPERSEDES ANY OTHERS CONTAINED IN THIS MANUAL FOR CROWN PRODUCTS. 9/07

## 10 Warranty



### SUMMARY OF WARRANTY

Crown International, 1718 West Mishawaka Road, Elkhart, Indiana 46517-4095 U.S.A. warrants to you, the ORIGINAL PURCHASER and ANY SUBSEQUENT OWNER of each NEW Crown1 product, for a period of three (3) years from the date of purchase by the original purchaser (the "warranty period") that the new Crown product is free of defects in materials and workmanship, and we further warrant the new Crown product regardless of the reason for failure, except as excluded in this Warranty.

*Warranty is only valid within the country in which the product is purchased.*

<sup>1</sup> Note: If your unit bears the name "Amcron," please substitute it for the name "Crown" in this warranty.

### ITEMS EXCLUDED FROM THIS CROWN-WARRANTY

This Crown Warranty is in effect only for failure of a new Crown product which occurred within the Warranty Period. It does not cover any product which has been damaged because of any intentional misuse, accident, negligence, or loss which is covered under any of your insurance contracts. This Crown Warranty also does not extend to the new Crown product if the serial number has been defaced, altered, or removed.

## WORLDWIDE EXCEPT USA & CANADA

### WHAT THE WARRANTOR WILL DO

We will remedy any defect, regardless of the reason for failure (except as excluded), by repair, replacement, or refund. We may not elect refund unless you agree, or unless we are unable to provide replacement, and repair is not practical or cannot be timely made. If a refund is elected, then you must make the defective or malfunctioning product available to us free and clear of all liens or other encumbrances. The refund will be equal to the actual purchase price, not including interest, insurance, closing costs, and other finance charges less a reasonable depreciation on the product from the date of original purchase. Warranty work can only be performed at our authorized service centers. We will remedy the defect and ship the product from the service center within a reasonable time after receipt of the defective product at our authorized service center.

### HOW TO OBTAIN WARRANTY SERVICE

You must notify your local Crown importer of your need for warranty service within the warranty period. All components must be shipped in the original box. Corrective action will be taken within a reasonable time of the date of receipt of the defective product by our authorized service center. If the repairs made by our authorized service center are not satisfactory, notify our authorized service center immediately.

### DISCLAIMER OF CONSEQUENTIAL AND INCIDENTAL DAMAGES

YOU ARE NOT ENTITLED TO RECOVER FROM US ANY INCIDENTAL DAMAGES RESULTING FROM ANY DEFECT IN THE NEW CROWN PRODUCT. THIS INCLUDES ANY DAMAGE TO ANOTHER PRODUCT OR PRODUCTS RESULTING FROM SUCH A DEFECT.

### WARRANTY ALTERATIONS

No person has the authority to enlarge, amend, or modify this Crown Warranty. This Crown Warranty is not extended by the length of time which you are deprived of the use of the new Crown product. Repairs and replacement parts provided under the terms of this Crown Warranty shall carry only the unexpired portion of this Crown Warranty.

### DESIGN CHANGES

We reserve the right to change the design of any product from time to time without notice and with no obligation to make corresponding changes in products previously manufactured.

### LEGAL REMEDIES OF PURCHASER

No action to enforce this Crown Warranty shall be commenced after expiration of the warranty period.

THIS STATEMENT OF WARRANTY SUPERSEDES ANY OTHERS CONTAINED IN THIS MANUAL FOR CROWN PRODUCTS. 9/07

## NOTES





**CROWN**

# PRODUCT REGISTRATION

Crown Audio, Inc.  
 1718 W. Mishawaka Rd.  
 Elkhart, IN 46517-9439  
 Phone: 574-294-8000  
 Fax: 574-294-8329  
 www.crownaudio.com

Online registration is also available at <http://crownweb.crownintl.com/webregistration>.

*Warranty is only valid within the country in which the product is purchased.*

When this form is used to register your product, it may be mailed or faxed.

Crown Audio, Inc.      Fax: 574-294-8329  
 1718 W Mishawaka Rd  
 Elkhart IN 46517

Please note that some information is required. Incomplete registrations will not be processed. \* Indicates required information.

## OWNER'S INFORMATION - PLEASE PRINT

\* First name: \_\_\_\_\_ Middle initial: \_\_\_\_\_ \* Last name: \_\_\_\_\_  
 Company: \_\_\_\_\_  
 \* Mailing address: \_\_\_\_\_  
 \* City: \_\_\_\_\_ \* State: \_\_\_\_\_ \* Zip Code: \_\_\_\_\_  
 \* Country: \_\_\_\_\_ E-mail address: \_\_\_\_\_  
 \* Phone # (include area code): \_\_\_\_\_ Fax #: \_\_\_\_\_

## PRODUCT INFORMATION

* MODEL	* SERIAL #	* PURCHASE DATE
e.g. IT8000, CDi1000, PCC160	e.g. 8000000000	mo/day/yr
_____	_____	____/____/____
_____	_____	____/____/____
_____	_____	____/____/____
_____	_____	____/____/____

Product purchased from: \*(Business/Individual) \_\_\_\_\_ Country: \_\_\_\_\_

Comments: \_\_\_\_\_  
 \_\_\_\_\_  
 \_\_\_\_\_

CUT ON THIS LINE

THIS PAGE INTENTIONALLY LEFT BLANK



# Crown Audio Factory Service Information

Shipping Address: Crown Audio Factory Service, 1718 W. Mishawaka Rd., Elkhart, IN 46517

**PLEASE PRINT CLEARLY**

SRA #: \_\_\_\_\_ (If sending product to Crown factory service.)      Model: \_\_\_\_\_      Serial Number: \_\_\_\_\_      Purchase Date: \_\_\_\_\_

**PRODUCT RETURN INFORMATION**

Individual or Business Name: \_\_\_\_\_

Phone #: \_\_\_\_\_      Fax #: \_\_\_\_\_      E-Mail: \_\_\_\_\_

Street Address (please, no P.O. Boxes): \_\_\_\_\_

City: \_\_\_\_\_      State/Prov: \_\_\_\_\_      Postal Code: \_\_\_\_\_      Country: \_\_\_\_\_

Nature of problem: \_\_\_\_\_

\_\_\_\_\_

\_\_\_\_\_

Other equipment in your system: \_\_\_\_\_

If warranty is expired, please provide method of payment. Proof of purchase may be required to validate warranty.

**PAYMENT OPTIONS**

I have open account payment terms. Purchase order required. PO#: \_\_\_\_\_       COD

Credit Card (Information below is required; however if you do not want to provide this information at this time, we will contact you when your unit is repaired for the information.)

**Credit card information:**

Type of credit card:     MasterCard       Visa       American Express       Discover

Type of credit card account:     Personal/Consumer       Business/Corporate

Card # \_\_\_\_\_ Exp. date: \_\_\_\_\_ \* Card ID #: \_\_\_\_\_

\* Card ID # is located on the back of the card following the credit card #, in the signature area. On American Express, it may be located on the front of the card. This number is required to process the charge to your account. If you do not want to provide it at this time, we will call you to obtain this number when the repair of your unit is complete.

Name on credit card: \_\_\_\_\_

Billing address of credit card: \_\_\_\_\_

\_\_\_\_\_



**H** A Harman International Company

## Free Manuals Download Website

<http://myh66.com>

<http://usermanuals.us>

<http://www.somanuals.com>

<http://www.4manuals.cc>

<http://www.manual-lib.com>

<http://www.404manual.com>

<http://www.luxmanual.com>

<http://aubethermostatmanual.com>

Golf course search by state

<http://golfingnear.com>

Email search by domain

<http://emailbydomain.com>

Auto manuals search

<http://auto.somanuals.com>

TV manuals search

<http://tv.somanuals.com>