

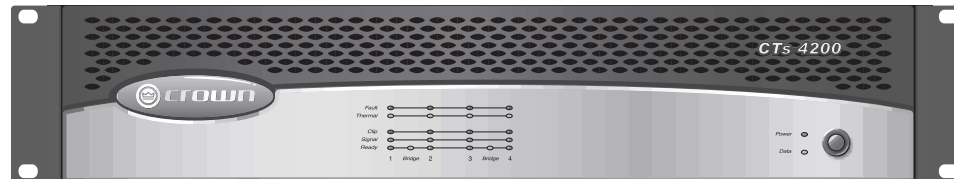

CTs Multi-Channel Series

Operation Manual



CTs 4200

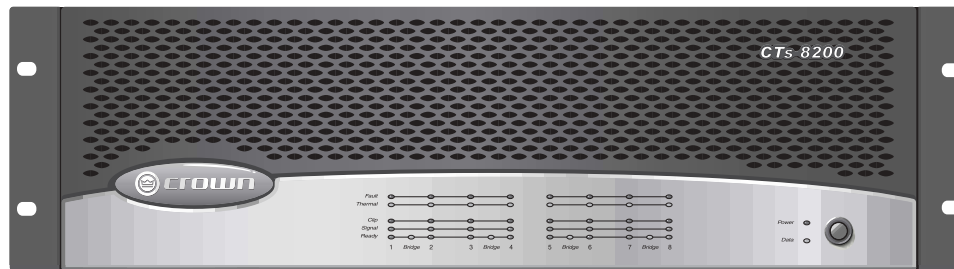

CTs 8200

Obtaining Other Language Versions: To obtain information in another language about the use of this product, please contact your local Crown Distributor. If you need assistance locating your local distributor, please contact Crown at 574-294-8000.

This manual does not include all of the details of design, production, or variations of the equipment. Nor does it cover every possible situation which may arise during installation, operation or maintenance.

The information provided in this manual was deemed accurate as of the publication date. However, updates to this information may have occurred. To obtain the latest version of this manual, please visit the Crown website at www.crownaudio.com.

Trademark Notice: Crown, Crown Audio, Amcron, Com-Tech, IQ System, and Multi-Mode are registered trademarks of Crown International. Other trademarks are the property of their respective owners.

Some models may be exported under the name Amcron.®

©2005 by Crown Audio® Inc., 1718 W. Mishawaka Rd., Elkhart, Indiana 46517-9439 U.S.A. Telephone: 574-294-8000

Important Safety Instructions

- 1) Read these instructions.
- 2) Keep these instructions.
- 3) Heed all warnings.
- 4) Follow all instructions.
- 5) Do not use this apparatus near water.
- 6) Clean only with a dry cloth.
- 7) Do not block any ventilation openings. Install in accordance with the manufacturer's instructions.
- 8) Do not install near any heat sources such as radiators, heat registers, stoves, or other apparatus (including amplifiers) that produce heat.
- 9) Do not defeat the safety purpose of the polarized or grounding-type plug. A polarized plug has two blades with one wider than the other. A grounding-type plug has two blades and a third grounding prong. The wide blade or the third prong is provided for your safety. If the provided plug does not fit into your outlet, consult an electrician for replacement of the obsolete outlet.
- 10) Protect the power cord from being walked on or pinched, particularly at plugs, convenience receptacles, and the point where they exit from the apparatus.
- 11) Only use attachments/accessories specified by the manufacturer.
- 12) Use only with a cart, stand, tripod, bracket, or table specified by the manufacturer, or sold with the apparatus. When a cart is used, use caution when moving the cart/apparatus combination to avoid injury from tip-over.
- 13) Unplug this apparatus during lightning storms or when unused for long periods of time.
- 14) Refer all servicing to qualified service personnel. Servicing is required when the apparatus has been damaged in any way, such as power-supply cord or plug is damaged, liquid has been spilled or objects have fallen into the apparatus, the apparatus has been exposed to rain or moisture, does not operate normally, or has been dropped.



- 15) WARNING: TO REDUCE THE RISK OF FIRE OR ELECTRIC SHOCK, DO NOT EXPOSE THIS APPARATUS TO RAIN OR MOISTURE.
- 16) DO NOT EXPOSE TO DRIPPING OR SPLASHING. DO NOT PLACE OBJECTS FILLED WITH LIQUID, SUCH AS VASES, ON THIS APPARATUS.



TO PREVENT ELECTRIC SHOCK DO NOT REMOVE TOP OR BOTTOM COVERS. NO USER SERVICEABLE PARTS INSIDE. REFER SERVICING TO QUALIFIED SERVICE PERSONNEL.

À PRÉVENIR LE CHOC ÉLECTRIQUE N'ENLEVEZ PAS LES COUVERCLES. IL N'Y A PAS DES PARTIES SERVICEABLE À L'INTÉRIEUR. TOUTS REPARATIONS DOIT ÊTRE FAIRE PAR PERSONNEL QUALIFIÉ SEULMENT.

TO COMPLETELY DISCONNECT THIS EQUIPMENT FROM THE AC MAINS, DISCONNECT THE POWER SUPPLY CORD PLUG FROM THE AC RECEPTACLE. THE MAINS PLUG OF THE POWER SUPPLY CORD SHALL REMAIN READILY OPERABLE.

IMPORTANT

CTs Series amplifiers require Class 2 output wiring.

MAGNETIC FIELD

CAUTION! Do not locate sensitive high-gain equipment such as preamplifiers or tape decks directly above or below the unit. Because this amplifier has a high power density, it has a strong magnetic field which can induce hum into unshielded devices that are located nearby. The field is strongest just above and below the unit.

If an equipment rack is used, we recommend locating the amplifier(s) in the bottom of the rack and the preamplifier or other sensitive equipment at the top.



WATCH FOR THESE SYMBOLS:



The lightning bolt triangle is used to alert the user to the risk of electric shock.



The exclamation point triangle is used to alert the user to important operating or maintenance instructions.

CAUTION
RISK OF ELECTRIC SHOCK
DO NOT OPEN

AVIS
RISQUE DE CHOC ÉLECTRIQUE
N'OUVREZ PAS

FCC COMPLIANCE NOTICE

This device complies with part 15 of the FCC rules. Operation is subject to the following two conditions: (1) This device may not cause harmful interference, and (2) this device must accept any interference received, including interference that may cause undesired operation.

CAUTION: Changes or modifications not expressly approved by the party responsible for compliance could void the user's authority to operate the equipment.

NOTE: This equipment has been tested and found to comply with the limits for a Class B digital device, pursuant to part 15 of the FCC Rules. These limits are designed to provide reasonable protection against harmful interference in a residential installation. This equipment generates, uses, and can radiate radio frequency energy and, if not installed and used in accordance with the instruction manual, may cause harmful interference to radio communications. However, there is no guarantee that interference will not occur in a particular installation. If this equipment does cause harmful interference to radio or television reception, which can be determined by turning the equipment off and on, the user is encouraged to try to correct the interference by one or more of the following measures:

- Reorient or relocate the receiving antenna.
- Increase the separation between the equipment and receiver.
- Connect the equipment into an outlet on a circuit different from that to which the receiver is connected.
- Consult the dealer or an experienced radio/TV technician for help.

Crown International, Inc.

DECLARATION of CONFORMITY

ISSUED BY: Crown International, Inc.
1718 W. Mishawaka Road
Elkhart, Indiana 46517 U.S.A.

FOR COMPLIANCE QUESTIONS ONLY: Sue Whitfield
574-294-8289
swhitfield@crowintl.com

European Representative's Name and Address:

Nick Owen
35, Bassets Field
Thornhill
Cardiff, South Glamorgan
CF14 9UG United Kingdom

Equipment Type: Commercial Audio Power Amplifiers

Family Name: CTs

Model Names: CTs 4200A, CTs 8200A

EMC Standards:

EN 55103-1:1995 Electromagnetic Compatibility - Product Family Standard for Audio, Video, Audio-Visual and Entertainment Lighting Control Apparatus for Professional Use, Part 1: Emissions

EN 55103-1:1995 Magnetic Field Emissions-Annex A @ 10 cm and 1 M

EN 61000-3-2:1995+A14:2000 Limits for Harmonic Current Emissions (equipment input current $\leq 16A$ per phase)

EN 61000-3-3:1995 Limitation of Voltage Fluctuations and Flicker in Low-Voltage Supply Systems Rated Current $\leq 16A$

EN 55022:1992 + A1: 1995 & A2:1997 Limits and Methods of Measurement of Radio Disturbance Characteristics of ITE: Radiated, Class B Limits; Conducted, Class B

EN 55103-2:1996 Electromagnetic Compatibility - Product Family Standard for Audio, Video, Audio-Visual and Entertainment Lighting Control Apparatus for Professional Use, Part 2: Immunity

EN 61000-4-2:1995 Electrostatic Discharge Immunity (Environment E2-Criteria B, 4k V Contact, 8k V Air Discharge)

EN 61000-4-3:1996 Radiated, Radio-Frequency, Electromagnetic Immunity (Environment E2, criteria A)

EN 61000-4-4:1995 Electrical Fast Transient/Burst Immunity (Criteria B)

EN 61000-4-5:1995 Surge Immunity (Criteria B)

EN 61000-4-6:1996 Immunity to Conducted Disturbances Induced by Radio-Frequency Fields (Criteria A)

EN 61000-4-11:1994 Voltage Dips, Short Interruptions and Voltage Variation

Safety Standard:

EN 60065: 1998 Safety Requirements - Audio Video and Similar Electronic Apparatus

I certify that the product identified above conforms to the requirements of the EMC Council Directive 89/336/EEC as amended by 92/31/EEC, and the Low Voltage Directive 73/23/EES as amended by 93/68/EEC.

Signed

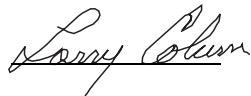

Larry Coburn

Title: Senior Vice President of Manufacturing

Date of Issue: March 1, 2002

Important Safety Instructions	2	5.1.4 35-Hz High-Pass Filter	14
Declaration of Conformity	3	5.1.5 AC Under-/Over-Voltage Protection	14
1 Welcome	5	5.1.6 Power Fuse	14
1.1 Features	5	5.1.7 Inrush Limiting	14
2 How to Use This Manual	5	5.1.8 Variable-speed Fans	14
3 Setup	6	5.2 Advanced Features	14
3.1 Unpack Your Amplifier	6	5.2.1 Switching Power Supply	14
3.2 Install Your Amplifier	6	5.2.2 Mode Switch	14
3.3 Ensure Proper Cooling	6	5.2.3 Bridge Mode Indicator	14
3.4 Choose Input Wire and Connectors	7	5.2.4 Channel Level Control	15
3.5 Choose Output Wire and Connectors	7	5.3 Options	16
3.6 Wire Your System	8	5.3.1 Control Modules	16
3.6.1 Dual 8/4 Mode	8	5.3.2 Input Sensitivity	16
3.6.2 Dual 70V Mode	8	6 Troubleshooting	17
3.6.3 Bridge-Mono 16/8 Mode	9	7 Specifications	19
3.6.4 Bridge-Mono 100V Mode	9	8 AC Power Draw and Thermal Dissipation	23
3.7 Connect to AC Mains	10	9 Service	25
3.8 Startup Procedure	10	9.1. International and Canada Service	25
4 Operation	11	9.2 US Service	25
4.1 Precautions	11	9.2.1 Service at a US Service Center	25
4.2 Front Panel Controls and Indicators	12	9.2.2 Factory Service	25
4.3 Back Panel Controls and Connectors	13	9.2.3 Factory Service Shipping Instructions	25
5 Advanced Features and Options	14	9.2.4 Packing Instructions	25
5.1 Protection Systems	14	9.2.5 Estimate Approval	25
5.1.1 Thermal Level Control (TLC)	14	9.2.6 Payment of Non-Warranty Repairs	25
5.1.2 Fault	14	10 Warranty	26
5.1.3 Fault Isolation Topology (FIT)	14	Crown Factory Service Information Form	29

CTs 4200

Dual

4 Channels Driven	1 kHz	20 Hz-20 kHz
4-ohm (per ch.)	260W	215W
8-ohm (per ch.)	180W	190W
70V (per ch.)	220W	220W*

1 Channel Driven

1 Channel Driven	1 kHz	20 Hz-20 kHz
4-ohm (per ch.)	270W	225W
8-ohm (per ch.)	220W	210W
70V (per ch.)	250W	245W*

Bridge-Mono

2 Channel-Pairs Driven	1 kHz	20 Hz-20 kHz
8-ohm (per ch. pair)	520W	430W
16-ohm (per ch. pair)	400W	380W
100V (per ch. pair)	220W	220W*

1 Channel-Pair Driven

1 Channel-Pair Driven	1 kHz	20 Hz-20 kHz
8-ohm (per ch. pair)	560W	450W
16-ohm (per ch. pair)	440W	420W
100V (per ch. pair)	250W	245W*

* Constant Voltage full bandwidth power ratings support 100Hz - 20kHz due to automatic High-Pass Filters.

Maximum Average Power in watts with 0.1% THD.



CTs 8200

Dual

8 Channels Driven	1 kHz	20 Hz-20 kHz
4-ohm (per ch.)	200W	175W
8-ohm (per ch.)	160W	155W
70V (per ch.)	200W	185W*

1 Channel Driven

1 Channel Driven	1 kHz	20 Hz-20 kHz
4-ohm (per ch.)	270W	230W
8-ohm (per ch.)	220W	220W
70V (per ch.)	250W	230W*

Bridge-Mono

4 Channel-Pairs Driven	1 kHz	20 Hz-20 kHz
8-ohm (per ch. pair)	400W	350W
16-ohm (per ch. pair)	320W	310W
100V (per ch. pair)	200W	185W*

1 Channel-Pair Driven

1 Channel-Pair Driven	1 kHz	20 Hz-20 kHz
8-ohm (per ch. pair)	540W	460W
16-ohm (per ch. pair)	440W	440W
100V (per ch. pair)	250W	230W*

* Constant Voltage full bandwidth power ratings support 100Hz - 20kHz due to automatic High-Pass Filters.

Maximum Average Power in watts with 0.1% THD.

1 Welcome

Building on the foundation of the *Com-Tech*[®] Series, Crown's CTs Series offers new flexibility and value for installed sound applications. The Com-Tech Series were the first to offer independent selection of high- and low-impedance operation for a specific channel, and CTs Series amplifiers continue that tradition, with power levels and features carefully chosen to perfectly integrate into fixed install design requirements.

Modern power amplifiers are sophisticated pieces of engineering capable of producing extremely high power levels. They must be treated with respect and correctly installed if they are to provide the many years of reliable service for which they were designed.

In addition, CTs Series amplifiers include a number of features which require some explanation before they can be used to their maximum advantage.

Please take the time to study this manual so that you can obtain the best possible service from your amplifier.

1.1 Features

- New Crown[®] Switching Power Supply for reduced weight.
- High power-density, with eight channels in a 3U chassis and four channels in a 2U chassis.
- Selectable constant-voltage (70V/100V) or low-impedance (8/4 ohm) operation for each channel pair.
- FIT (Fault Isolation Topology) circuitry isolates faults within affected channels.
- 35 Hz High-Pass Filter (70 Hz in CTs 4200) is automatically inserted when the channel pair is set for constant-voltage operation. (corner frequency may be changed as a service option).
- Accepts new MC accessory modules that tailor the amplifier to suit specific applications. Modules available for remote VCA level control and *IQ System*[®] Control.
- Comprehensive array of indicators including Power and Data, along with Bridge, Ready, Signal, Clip, Thermal and Fault for each channel, provide accurate diagnostics.
- Blue Power Indicator flashes if the amplifier shuts off due to an under-/over-voltage condition on the AC mains.
- Advanced protection circuitry guards against: shorted outputs, open circuits, DC, mismatched loads, general overheating, under-/over-voltage, high-frequency overloads and internal faults.
- Proven Crown AB+B *Multi-Mode*[®] output topology.

- Continuously-variable-speed fans optimize cooling efficiency.
- Three Year, No-Fault, Fully-Transferable Warranty completely protects your investment and guarantees its specifications.

2 How to Use This Manual

This manual provides you with the necessary information to safely and correctly setup and operate your amplifier. It does not cover every aspect of installation, setup or operation that might occur under every condition. For additional information, please consult Crown's *Amplifier Application Guide* (available online at www.crownaudio.com), Crown Tech Support, your system installer or retailer.

We strongly recommend you read all instructions, warnings and cautions contained in this manual. Also, for your protection, please send in your warranty registration card today, or register online at www.crownaudio.com. And save your bill of sale—it's your official proof of purchase.

3 Setup

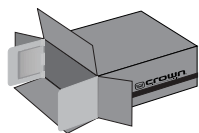

3.1 Unpack Your Amplifier

Please unpack and inspect your amplifier for any damage that may have occurred during transit. If damage is found, notify the transportation company immediately. Only you can initiate a claim for shipping damage. Crown will be happy to help as needed. Save the shipping carton as evidence of damage for the shipper's inspection.

We also recommend that you save all packing materials so you will have them if you ever need to transport the unit. **Never ship the unit without the factory pack.**

YOU WILL NEED (not supplied):

- Input wiring cables
- Output wiring cables

Rack for mounting amplifier (or a stable surface for stacking)



WARNING: Before you start to set up your amplifier, make sure you read and observe the Important Safety Instructions found at the beginning of this manual.



3.2 Install Your Amplifier

CAUTION: Before you begin, make sure your amplifier is disconnected from the power source, with the power switch in the "off" position and all level controls turned completely down (counterclockwise).

Use a standard 19-inch (48.3-cm) equipment rack (EIA RS-310B). See Figure 3.1 for amplifier dimensions.

You may also stack amps without using a cabinet.

NOTE: When transporting, amplifiers should be supported at both front and back.

3.3 Ensure Proper Cooling

When using an equipment rack, mount units directly on top of each other. Close any open spaces in rack with blank panels. DO NOT block front, rear or side air vents. The side walls of the rack should be a minimum of two inches (5.1 cm) away from the amplifier sides, and the back of the rack should be a minimum of four inches (10.2 cm) from the amplifier back panel.

Figure 3.2 illustrates standard amplifier airflow.

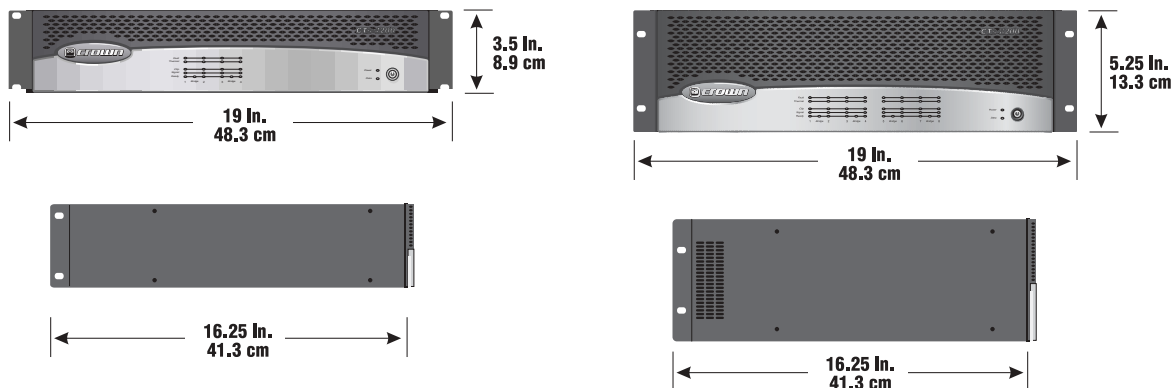

Figure 3.1 Dimensions
Left: CTs 4200 Right: CTs 8200

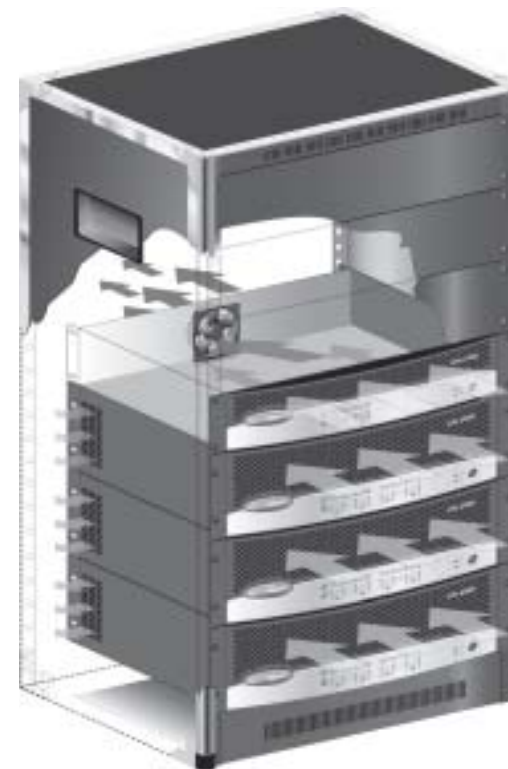

Figure 3.2 Airflow

3 Setup

3.4 Choose Input Wire and Connectors

Figure 3.3 shows connector pin assignments for balanced wiring, and Figure 3.4 shows connector pin assignments for unbalanced wiring.

When possible, use balanced wiring for signal input, which provides better rejection of unwanted noise and hum. For more information, refer to the *Crown Amplifier Application Guide*, available online at www.crownaudio.com



NOTE: Custom wiring should only be performed by qualified personnel.

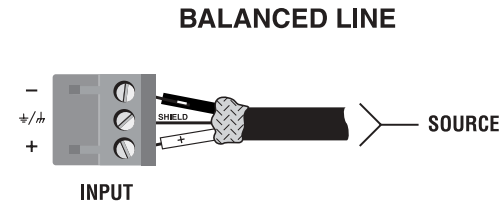

Figure 3.3 Balanced Input Connector Wiring

See the *Crown Amplifier Application Guide*, available online at www.crownaudio.com, for pin assignments for commonly used connector types.

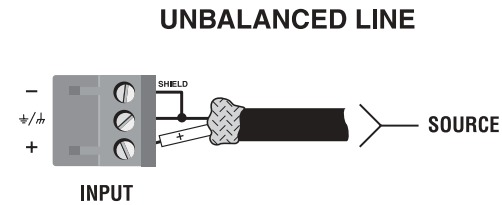

Figure 3.4 Unbalanced Input Connector Wiring

3.5 Choose Output Wire and Connectors

Crown recommends using professionally constructed, high-quality, two- or four-conductor, heavy gauge speaker wire and connectors. You may use terminal forks or bare wire for your output connectors (see Figure 3.5). CTs amplifier terminal strips accept up to 10 AWG terminal forks which fit over a #8 screw. For best results, Crown recommends Panduit part #PV10-10LF-L or equivalent terminal fork. Screw spacing is shown in Figure 3.5.

To connect outputs, first remove the touch-proof cover plate covering the terminal strip by removing the screw which holds it in place.

To prevent the possibility of short-circuits, wrap or otherwise insulate exposed loudspeaker cable and connectors. Also, a touch-proof cover plate, which covers the terminal strips, is provided to help prevent short circuits. The cover plate should be reinstalled after connecting outputs.

Suggested below are guidelines to select the appropriate size of wire based on the distance from amplifier to speaker. Check with local code as this may vary.

Distance	Wire Size
up to 25 ft (7.6 m)	16 AWG
26-40 ft (7.9-12.2 m)	14 AWG
41-60 ft (12.5-18.3 m)	12 AWG
Over 60 ft (18.3 m)	10 AWG



CAUTION: Never connect the speaker return to the chassis of the amplifier, or damage to the amplifier may result.

CAUTION: Never use shielded cable for output wiring.

NOTE: CTs 8200 is shown. Some CTs 4200 features are in different locations.

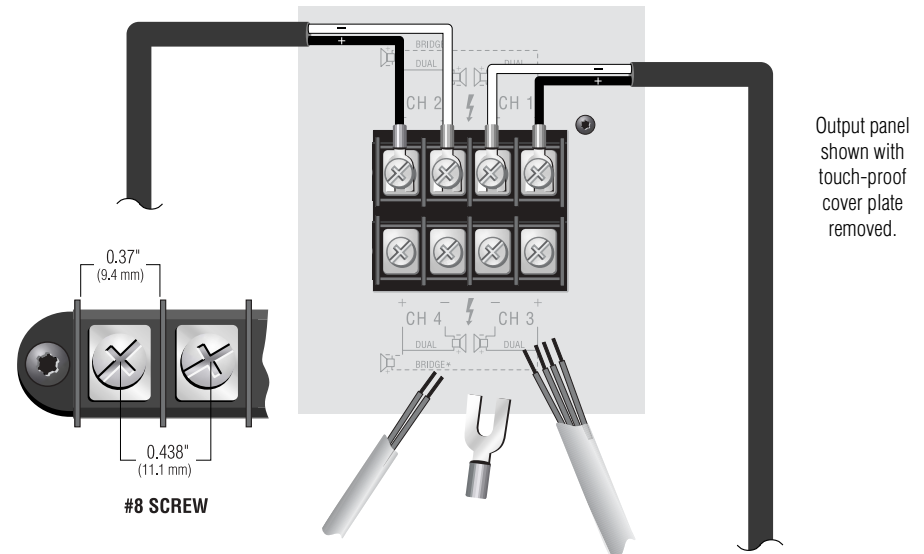

Figure 3.5 Output Connector Wiring (Typical of two channels)

3 Setup

3.6 Wire Your System



CAUTION: Never change the position of the Mode Switch while the amplifier power is on. See Section 5.2.2 for more information.

3.6.1 Dual 8/4 Mode

Typical input and output wiring, along with level control and Mode Switch settings are shown in Figure 3.6. Make sure the Mode switch is set to the "Dual 8/4" position.

INPUTS: Connect input wiring for each channel.

OUTPUTS: Maintain proper polarity (+/-) on output connectors.

Connect the Channel 1 speaker's positive (+) lead to amplifier Channel 1 positive terminal; repeat for negative (-). Repeat each channel wiring as for Channel 1. Refer to Section 3.5 for output connector pin assignments.

3.6.2 Dual 70V Mode



CAUTION: Never change the position of the Mode Switch while the amplifier power is on. See Section 5.2.2 for more information.

Typical input and output wiring, along with level control and Mode Switch settings are shown in Figure 3.7. Make sure the Mode switch is set to the "Dual 70V" position.

INPUTS: Connect input wiring for each channel.

OUTPUTS: Maintain proper polarity (+/-) on output connectors.

Connect Channel 1 positive (+) speaker load to Channel 1 positive terminal of amp; repeat for negative (-). Repeat each channel wiring as for Channel 1. Refer to Section 3.5 for output connector pin assignments.

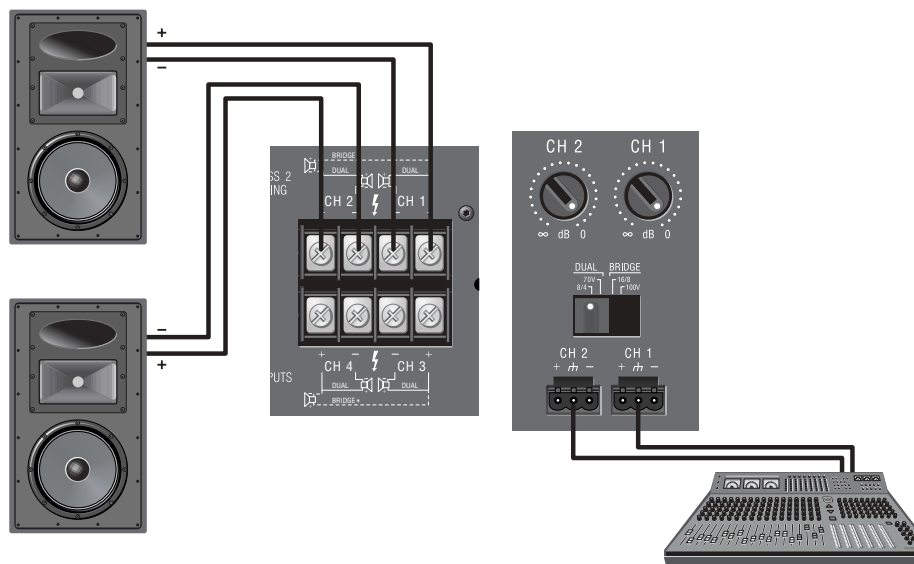

See the Crown Amplifier Application Guide, available online at www.crownaudio.com, for pin assignments for commonly used connector types.

Output panel shown with touch-proof cover plate removed.

Figure 3.6 System Wiring and Control Settings, Dual Mode, 8/4 Ohm

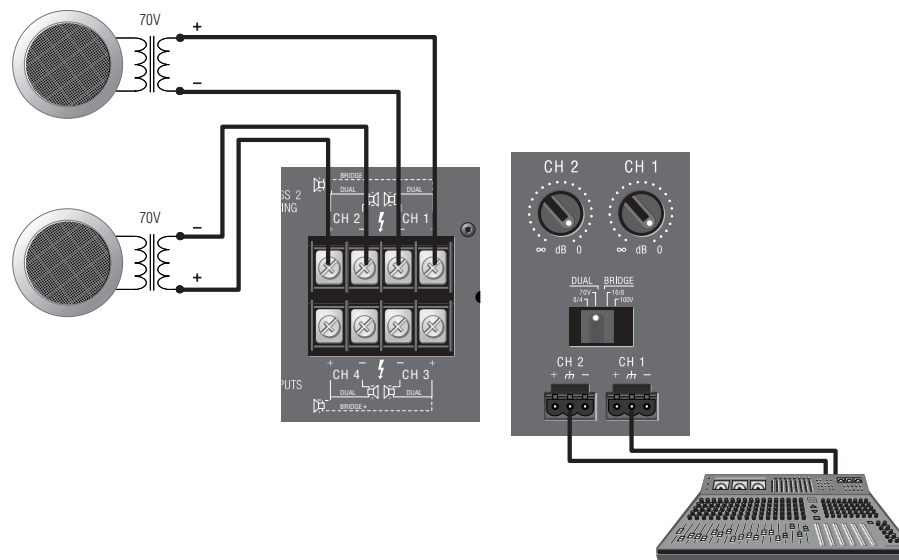

Output panel shown with touch-proof cover plate removed.

Figure 3.7 System Wiring and Control Settings, Dual Mode, 70V.

3 Setup



3.6.3 Bridge-Mono 16/8 Mode

CAUTION: Never change the position of the Mode Switch while the amplifier power is on. See Section 5.2.2 for more information.

Typical input and output wiring, along with level control and Mode Switch settings are shown in Figure 3.8. Make sure the Mode switch is set to the "Bridge 16/8" position.

INPUTS: Connect input wiring only to the lower- (odd-) numbered channel pair.

OUTPUTS: Connect the speaker across the positive terminals of each channel pair. Do not use the negative terminals of the channel pair when the pair is being operated in Bridge-Mono mode.

NOTE: When operating the channel pair in Bridge-Mono mode, turn down (full CCW) the level control for the higher (even)-numbered channel of the channel pair. The lower (odd)-numbered level control works both channels.



3.6.4 Bridge-Mono 100V Mode

CAUTION: Never change the position of the Mode Switch while the amplifier power is on. See Section 5.2.2 for more information.

Typical input and output wiring, along with level control and Mode Switch settings are shown in Figure 3.9. Make sure the Mode switch is set to the "Bridge 100V" position.

INPUTS: Connect input wiring only to the lower- (odd-) numbered channel pair.

OUTPUTS: Connect the speaker across the positive terminals of each channel pair. Do not use the negative terminals of the channel pair when the pair is being operated in Bridge-Mono mode.

NOTE: When operating the channel pair in Bridge-Mono mode, turn down (full CCW) the level control for the higher (even)-numbered channel of the channel pair. The lower (odd)-numbered level control works both channels.

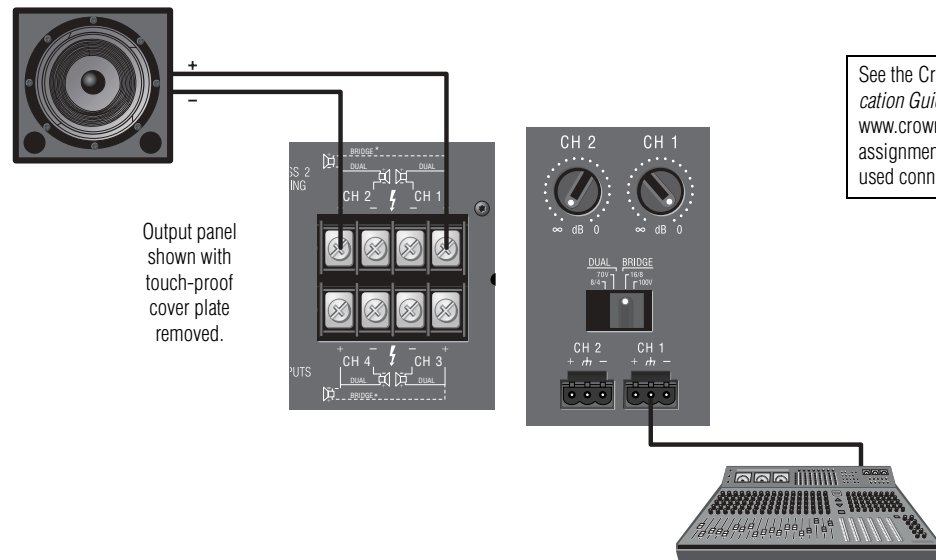

See the *Crown Amplifier Application Guide*, available online at www.crownaudio.com, for pin assignments for commonly used connector types.

Figure 3.8 System Wiring and Control Settings, Bridge-Mono Mode, 16/8 Ohm.

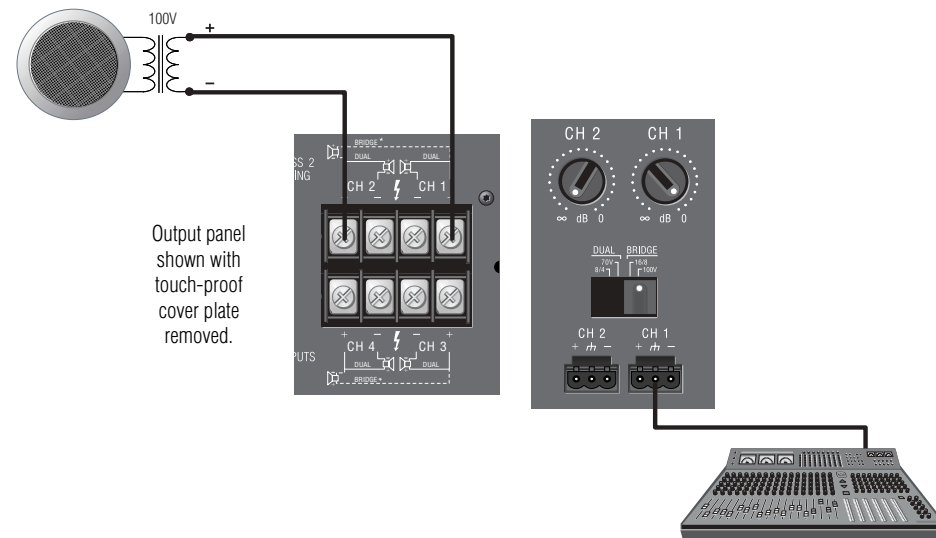

Figure 3.9 System Wiring and Control Settings, Bridge-Mono Mode, 100V

3 Setup

3.7 Connect to AC Mains

Connect your amplifier to the AC mains power source (power outlet) with the supplied AC power cordset. First, connect the IEC end of the cordset to the IEC connector on the amplifier; then, plug the other end of the cordset to the AC mains.



WARNING: The third prong of this connector (ground) is an important safety feature. Do not attempt to disable this ground connection by using an adapter or other methods.

Amplifiers don't create energy. The AC mains voltage and current must be sufficient to deliver the power you expect. If the AC line voltage varies out of an acceptable range, the amplifier's power supply turns off and the blue Power LED flashes. The amplifier will turn back on when the AC line voltage returns to safe operating levels. Figure 3.10 provides voltage limits for all amplifier AC voltage configurations. Also, the amplifier must be run within the specified mains frequency requirements (indicated on the amplifier's back panel label). If you are unsure of the output voltage of your AC mains, please consult your electrician.

Models	Under-Voltage Limit	Over-Voltage Limit
100VAC (CTs 8200 only)	90VAC	110VAC
120 VAC units	108VAC	132VAC
220V/230V/ 240V units	198VAC	264VAC

Figure 3.10 AC Under-Voltage and Over-Voltage Limits for Various Amplifier Models

3.8 Startup Procedure

Use the following procedure when first turning on your amplifier:

1. Turn down the level of your audio source.
2. Turn down the level controls of the amplifier.
3. Turn on the "Power" switch. The Power indicator should glow.
4. Turn up the level of your audio source to an optimum level.
5. Turn up the Level controls on the amplifier until the desired loudness or power level is achieved.
6. Turn down the level of your audio source to its normal range.

If you ever need to make any wiring or installation changes, don't forget to disconnect the power cord.

For help with determining your system's optimum gain structure (signal levels) please refer to the *Crown Amplifier Application Guide*, available online at www.crownaudio.com.

4 Operation

4.1 Precautions

Your amplifier is protected from internal and external faults, but you should still take the following precautions for optimum performance and safety:

1. Before use, your amplifier first must be configured for proper operation, including input and output wiring hookup. Improper wiring can result in serious operating difficulties. For information on wiring and configuration, please consult the Setup section of this manual or, for advanced setup techniques, consult Crown's *Amplifier Application Guide* available online at www.crownaudio.com.
2. Use care when making connections, selecting signal sources and controlling the output level. The load you save may be your own!
3. Do not short the ground lead of an output cable to the input signal ground. This may form a ground loop and cause oscillations.
4. **WARNING: Never connect the output to a power supply, battery or power main. Electrical shock may result.** 
5. Tampering with the circuitry, or making unauthorized circuit changes may be hazardous and invalidates all agency listings, and may also void the product's warranty.
6. Do not operate the amplifier with the red Clip LEDs constantly flashing.
7. Do not overdrive the mixer, which will cause clipped signal to be sent to the amplifier. Such signals will be reproduced with extreme accuracy, and loudspeaker damage may result.
8. Use caution when operating the amplifier with a 2-ohm load impedance on 1 channel. Do not operate the amplifier with less than a 2-ohm load impedance per channel when driving more than 1 channel. Due to the amplifier's output protection, such a configuration may result in premature clipping, speaker damage or a blown power fuse.

Remember: Crown is not liable for damage that results from overdriving other system components.

4 Operation

4.2 Front Panel Controls and Indicators

Note: CTs 8200 is shown. Some CTs 4200 features are in different locations.

A. Bridge Mode Indicator

Yellow LED, one per channel pair, illuminates when the channel pair's Mode Switch is set to the "Bridge" position. If Mode switch is changed while amplifier is powered up, Bridge LED will flash, indicating that the amplifier must be powered off and on to reset the Mode. See Section 6.9.

B. Ready Indicator

Green LED, one per channel, illuminates when the channel is initialized and ready to produce audio output.

C. Signal Indicator

Green LED, one per channel, illuminates to indicate the presence of input signals above -40 dBu.

D. Clip Indicator

Red LED, one per channel, illuminates when the THD of the channel's output signal rises to a level typically considered as the onset of audible clipping. The Clip Indicator also will illuminate during Thermal Level Control (TLC) or input overload.

E. Thermal Indicator

Red LED, one per channel, flashes when the channel has shut down due to thermal stress or overload. If the power supply goes into thermal overload, all channel LEDs will flash.

F. Fault Indicator

Red LED, one per channel, illuminates when the amplifier output channel has stopped operating.

G. Ventilation Grille

Front-to-rear forced airflow.

H. Data Indicator

Yellow LED indicates IQ Loop data activity (if the amplifier is equipped with an IQ-MC module, and connected to an IQ Loop).

I. Power Indicator

Blue LED indicates amplifier has been turned on and AC power is available. Indicator also flashes if the amplifier shuts off due to an under/over-voltage condition on the AC mains.

J. Power Switch

Amplifier is on when the switch is in the IN position.

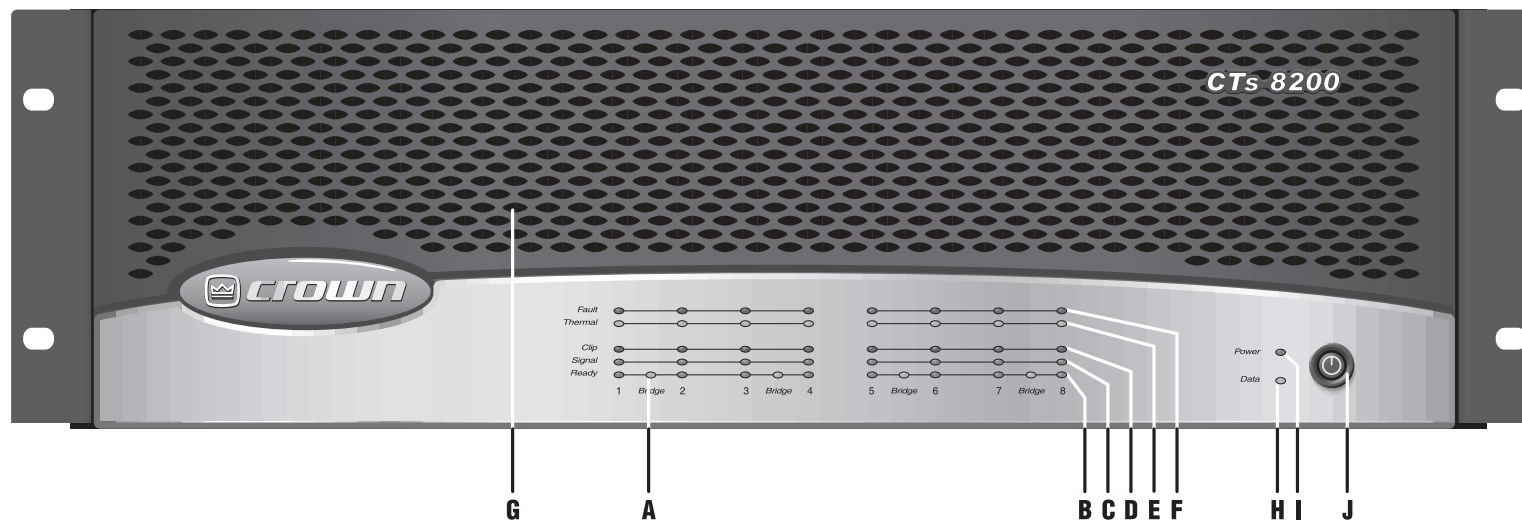

Figure 4.1 CTs 8200 front panel.

4 Operation

4.3 Back Panel Controls and Connectors

Note: CTs 8200 is shown. Some CTs 4200 features are in different locations.

K. AC Power Cord Connector

Standard IEC type 320 inlet.
120V models: 15-amp.
220-240V models: 10-amp.
Voltage is indicated above IEC inlet.

L. Output Connectors

One four-pole terminal strip for every two channels with touch-proof cover. Accepts up to 10 AWG terminal forks. To connect outputs, first remove the touch-proof cover plate covering the terminal strip by removing the screw which holds it in place.

M. Accessory Panel

CTs 4200: Accepts an optional IQ-MC4A or VCA-MC4A module.

CTs 8200: Accepts an optional IQ-MC8 or VCA-MC8 module (explained in Section 5.3.1, Control Modules).

N. Channel Level Controls

One 21-position detented rotary potentiometer per channel, ranging from infinity (-70 dB) to 0 dB attenuation. Refer to Section 5.2.4 for precise dB attenuation increments for each detent.

O. Input Connectors

Removable Phoenix-style barrier connectors for balanced input.

P. Mode Switch

Used on each consecutive pair of channels, this four-position switch is used to select the amplifier's mode of operation: Dual 8/4 ohms, Dual 70V, Bridge-Mono 16/8 ohms, and Bridge-Mono 100V.



IMPORTANT: Be sure to power off the amplifier before change the Mode-switch setting. If this is not done, the Bridge light will flash to indicate that the power must be cycled off and back on to reset the mode.

Q. Cooling Vents

Front-to-rear forced airflow.

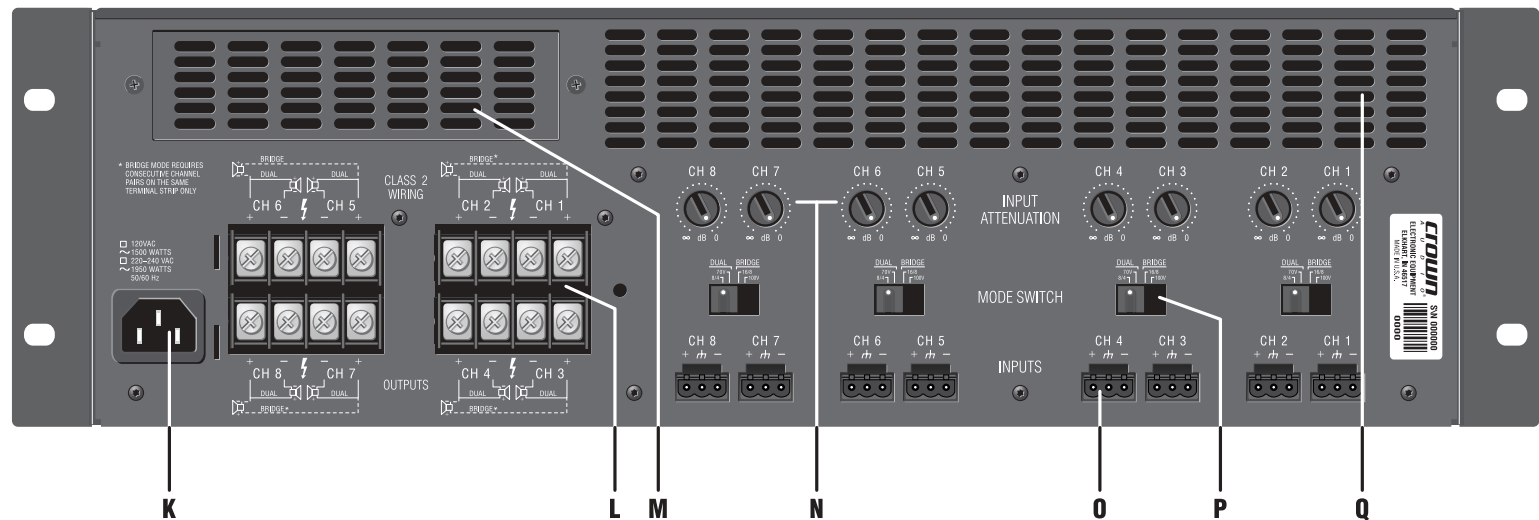

Figure 4.2 CTs 8200 back panel (shown with touch-proof cover removed).

5 Advanced Features and Options

NOTE: For more information about these Crown amplifier features, please visit the Crown website at www.crownaudio.com.

5.1 Protection Systems

Your Crown amplifier provides extensive protection and diagnostic capabilities, including thermal level control, fault indicators, automatic high-pass filtering, DC protect, AC under-/over-voltage protection, inrush limiting, and variable-speed fans.

5.1.1 Thermal Level Control (TLC)

If an amplifier channel starts to overheat, the TLC circuit will engage that channel's input compressor. By compressing the input, the amplifier will not generate as much heat and will have a chance to cool down. The degree of compression is proportional to the amount of overheating. If the channel becomes too hot for safe operation even after full TLC limiting, the channel will shut off, and the Thermal Indicator for that channel will flash brightly to alert the user that a state of thermal stress or overload has caused the channel to shut down.

5.1.2 Fault

If an amplifier channel requires service, the corresponding Fault indicator will illuminate to alert the user of this condition. If this occurs, return the amplifier to the Crown factory or to an authorized Crown service center.

5.1.3 Fault Isolation Topology (FIT)

Crown's new FIT (Fault Isolation Topology) design isolates channel-specific faults, and prevents them from affecting remaining channels. If a CTs multi-channel amp is powering multiple zones, and a channel fails, the other zones continue to operate. FIT makes the CTs 4200 and CTs 8200 the most trustworthy multi-channel amplifiers in the business!

5.1.4 35-Hz High-Pass Filter

A fixed 35-Hz (70-Hz in CTs 4200) high-pass filter per channel pair is automatically inserted when the mode switch is set to either of the constant-voltage settings. The high-pass filter corner frequency can be set to 70 Hz, or bypassed, with a service option.

5.1.5 AC Under-/Over-Voltage Protection

If the AC line voltage varies out of an acceptable range, the amplifier's power supply turns off and the blue Power LED flashes. The amplifier will turn back on when the AC line voltage returns to safe operating levels. Figure 5.1 provides voltage limits for all amplifier AC voltage configurations. Also, the amplifier must be run within the specified mains frequency requirements (indicated on the amplifier's back panel label). If you are unsure of the output voltage of your AC mains, consult your electrician.

Models	Under-Voltage Limit	Over-Voltage Limit
100VAC (CTs 8200 only)	90VAC	110VAC
120 VAC units	108VAC	132VAC
220V/230V/240V units	198VAC	264VAC

Figure 5.1 AC Under-Voltage and Over-Voltage Limits for Various Amplifier Models

5.1.6 Power Fuse

A fuse protects the amplifier from excessive AC current draw.

5.1.7 Inrush Limiting

A soft-start circuit in the power supply minimizes the amplifier's current draw during power-on.

5.1.8 Variable-speed Fans

Continuously variable speed fans direct the airflow through the amplifier for cooling.

5.2 Advanced Features

5.2.1 Switching Power Supply

Crown's new Switching Power Supply minimizes the amplifier's weight.

Typical non-switching power supplies require large, heavy transformers in order to produce the required power at the output stage. These transformers must be large to absorb the substantial waste that occurs when operating at 50 to 60 Hz (standard AC supplied by the power company).

By contrast, switching power supplies can operate with a much smaller (and lighter) transformer because they first convert the AC up to a much higher frequency, thereby reducing waste.

The power supply is voltage-specific, allowing use in regions using 120V/60Hz, 220V/50Hz, 230V/50Hz, 240V/50Hz, and 100V/50Hz AC mains.

5.2.2 Mode Switch

Each consecutive pair of channels has one four-position switch that selects the amplifier's mode of operation. The switch positions are:

- Dual mode for 4 or 8 ohm operation.
- Dual mode for 70V constant-voltage operation.
- Bridge-Mono mode for 8 or 16 ohm operation.
- Bridge-Mono mode for 100V constant-voltage operation.

Be sure to turn off the amplifier before changing the Mode-switch setting.

5.2.3 Bridge Mode Indicator

This yellow LED indicates when the amplifier's mode switch is set to the Bridge position. Each consecutive pair of channels has one Bridge LED.



5 Advanced Features and Options

5.2.4 Channel Level Control

The signal level for each input can be attenuated accurately by adjusting the 21-step Level Control (see Section 4.2). Figure 5.2 shows the amount of attenuation in dB for each detent.

Note: Attenuation per detent varies with operating mode since gain varies with operating mode. Attenuation amounts shown may vary $\pm 6\%$.

ATTENUATION in dB

Detent	4/8 Ohm	70V	100V
0 (full CCW)	-68.31	-72.90	-71.02
1	-67.54	-72.06	-70.26
2	-32.23	-36.61	-34.90
3	-25.46	-29.74	-28.00
4	-21.83	-25.87	-24.22
5	-19.23	-23.20	-21.58
6	-17.12	-20.94	-19.40
7	-15.36	-19.02	-17.53
8	-13.76	-17.22	-15.79
9	-12.28	-15.53	-14.20
10	-10.84	-13.90	-12.62
11	-9.51	-12.32	-11.16
12	-8.28	-10.87	-9.81
13	-7.09	-9.45	-8.45
14	-6.30	-8.11	-7.22
15	-4.92	-6.70	-5.94
16	-3.82	-5.26	-4.63
17	-2.62	-3.70	-3.21
18	-1.35	-1.90	-1.66
19	-0.01	-0.01	-0.01
20 (full CW)	0.00	0.00	0.00

Figure 5.2 Level-control Attenuation per Detent

5 Advanced Features and Options

5.3 Options

Below are some available options. For current options, visit the Crown website at www.crownaudio.com.

5.3.1 Control Modules

IQ-MC (IQ Module): See Figure 5.3. A single IQ-MC module provides IQ control and monitoring capability to all channels of the amplifier. Features include basic IQ amplifier control and monitoring, including attenuation, mute, polarity, input level, output level, power supply temperature, and thermal level meters. Advanced features include IOC, Thermal and Fault error reporting, Load Supervision, output limiting, Listen Bus, AUX control port, 10 presets, and real-time “read-only” software indication of amplifier hardware indicator, level control, and mode switch status.

VCA-MC (VCA module): See Figure 5.4. Provides independent remote level control for each channel. 4-pin removable Phoenix-style barrier connectors provide the +10VDC control voltage, ground, and control lines for two amplifier channels. Thus, 4-channel amplifiers use two connectors; 8-channel amplifiers use four connectors.

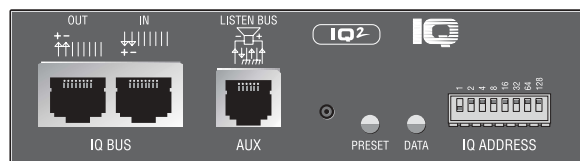

Figure 5.3 IQ-MC8 Module

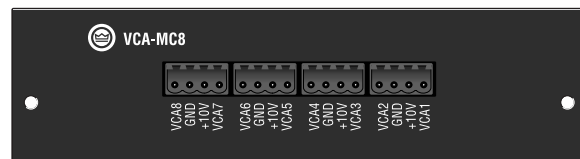

Figure 5.4 VCA-MC8 Module

Wall-Mount level control panels for use with VCA module:

1-VCAP: See Figure 5.5. Used in conjunction with a VCA-MC module, this is a single-gang panel providing remote volume control for one or more CTs amplifier channels. The potentiometer on the panel is wired directly to one of the VCA connectors on the VCA-MC.

4-VCAP: See Figure 5.6 This is a two-gang panel providing remote volume control for four or more CTs amplifier channels. The potentiometers on the panel are wired directly to the respective VCA connector on the VCA-MC.

Refer to the VCA-MC Operation Manual for wiring of the single or multiple channel level control.

Your amplifier may have come with an IQ-MC or VCA-MC module already factory-installed, or your choice of MC modules can be easily added to the amplifier by any authorized Crown Service Center. Contact Crown Technical Support for more details.

Choosing the Right Module

To order accessory modules for your amplifier, please refer to the model tag (located on the back panel of the amplifier) for your amplifier's specific model number. Then refer to the chart below to select the correct accessory for your requirements.

	MC MODULE	VCA MODULE
CTs 4200	IQ-MC4	VCA-MC4
CTs 4200A	IQ-MC4A	VCA-MC4A
CTs 8200	IQ-MC8	VCA-MC8
CTs 8200A	IQ-MC8	VCA-MC8

1-VCAP: Single-gang wall-mount panel with one VCA channel volume control (for any CTs model)

4-VCAP: Two-gang wall-mount panel with four VCA channel volume controls (for any CTs model)

5.3.2 Input Sensitivity

The CTs 4200 and CTs 8200 have a fixed input sensitivity of 1.4V. A service option is available for other input sensitivities.

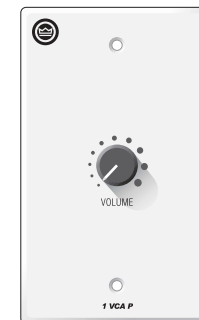

Figure 5.5 1-VCAP Module



Figure 5.6 4-VCAP Module

6 Troubleshooting

Fault	●			
Thermal	●			
Clip	●		Power	●
Signal	●		Data	●
Ready	●	1	Bridge	

CONDITION: Power indicator is off.

POSSIBLE REASON

- The amplifier has lost AC power.
- The amplifier's Power switch is off.
- The amplifier is not plugged into the power receptacle.
- The amplifier output level is so high that the power supply fuse has blown. Verify that input levels and output impedances are within safe ranges. Refer the unit to an authorized Crown service center for fuse replacement.

Fault	☀			
Thermal	●		Power	☀
Clip	●		Data	●
Signal	●			
Ready	●	1	Bridge	

CONDITION: Fault indicator is on.

POSSIBLE REASON:

- The amplifier channel has stopped operating. Return the unit to an authorized Crown Service Center.

Fault	●			
Thermal	●		Power	☀
Clip	●		Data	●
Signal	●			
Ready	●	1	Bridge	

CONDITION: Power indicator is flashing.

POSSIBLE REASON:

- The AC line voltage has dropped below 10% or has risen above 10% of the nominal line voltage of the power supply.

Refer to section 5.1.6 for specific voltage requirements.

Fault	●			
Thermal	●		Power	☀
Clip	☀		Data	●
Signal	☀			
Ready	☀	1	Bridge	

CONDITION: Distorted sound.



POSSIBLE REASON:

- Load is wired incorrectly or Dual/Bridge mode switch is set incorrectly. Check both.
- Input is overloaded by a signal level that is too high. Turn down your amplifier level controls, or turn down the input signal, until the clip light goes out.
- Thermal Level Control (TLC) is active.

Note: If the signal sounds distorted even though the Clip LED is off, the input signal is distorted. Check gain staging and output levels of the mixer or preamp.

Key	☀	Lit
	◐	Flashing
	●	Off

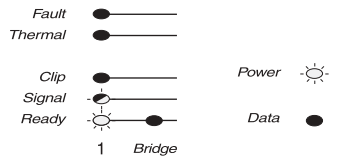
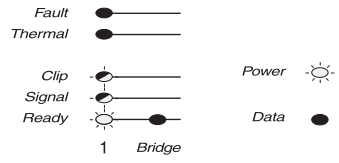
6 Troubleshooting

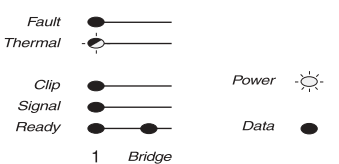

	<p>CONDITION: No sound, even though the amp has power. Power LED is on without flashing and the amp is receiving an input signal. Signal indicator is flashing.</p> <ul style="list-style-type: none"> Speakers not connected. Open circuit due to speaker failure.
	<p>There is a short on the amplifier output. First disconnect your speakers from the affected channel(s) one by one to determine if one of the loads is shorted.</p>
	<ul style="list-style-type: none"> DC or excessive low-frequency signal at the amplifier's output has enabled speaker protection.

	<p>CONDITION: Thermal indicator is flashing.</p> <p>POSSIBLE REASON:</p> <ul style="list-style-type: none"> The amplifier has become too hot for safe operation. Check for loads less than 2 ohms, and for excessive input levels. Check for proper ventilation and proper mode-switch setting. Driving low-impedance loads while in high-voltage mode can cause overheating.
---	--

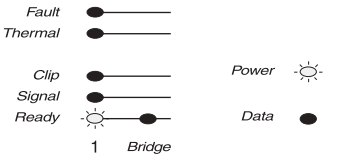
	<p>CONDITION: All channel thermal indicators are flashing.</p> <p>POSSIBLE REASON:</p> <ul style="list-style-type: none"> Power supply thermal overload.
---	---

	<p>CONDITION: No input signal. (Signal indicator is not flashing even though audio is applied and channel is ready).</p> <p>POSSIBLE REASON:</p> <ul style="list-style-type: none"> Input signal level is very low. Input cables have become disconnected.
---	--

	<p>CONDITION: Bridge LED is flashing.</p> <p>POSSIBLE REASON:</p> <ul style="list-style-type: none"> The mode switch was switched while the power was on.
---	--

<p>Key</p>	 <p>Lit</p>
	 <p>Flashing</p>
	 <p>Off</p>

7 Specifications

CTs 4200: MINIMUM GUARANTEED POWER (in watts, 0.1% THD) 120VAC, 60 Hz units					
Dual Mode					
Channels Driven	4		2	1	
	1 kHz	20 Hz - 20 kHz	1 kHz	1 kHz	20 Hz - 20 kHz
4 Ohm	260	215	270	270	225
8 Ohm	180	190	210	220	210
70V (25 Ohm) at 0.1% THD	220	220*	240	250	245*
Bridge-Mono Mode					
Channel Pairs Driven	2		1		
	1 kHz	20 Hz - 20 kHz	1 kHz	20 Hz - 20 kHz	
8 Ohm	520	430	560	450	
16 Ohm	400	380	440	420	
100V (50 Ohm) at 0.1% THD	220	220*	250	245*	

Figure 7.1
CTs 4200
Power Chart

* Constant Voltage full bandwidth power ratings support 100 Hz - 20 kHz due to automatic high-pass filters.

CTs 8200: MINIMUM GUARANTEED POWER (In watts, 0.1% THD) 120VAC, 60 Hz units						
Dual Mode						
Channels Driven	8		4	2	1	
	1 kHz	20 Hz - 20 kHz	1 kHz	1 kHz	1 kHz	20 Hz - 20 kHz
4 Ohm	200	175	250	260	270	230
8 Ohm	160	155	190	200	220	220
70V (25 Ohm) at 0.1% THD	200	185*	220	240	250	230*
Bridge-Mono Mode						
Channel Pairs Driven	4		2	1		
	1 kHz	20 Hz - 20 kHz	1 kHz	1 kHz	20 Hz - 20 kHz	
8 Ohm	400	350	500	540	460	
16 Ohm	320	310	380	440	440	
100V (50 Ohm) at 0.1% THD	200	185*	220	250	230*	

Figure 7.2
CTs 8200
Power Chart

* Constant Voltage full bandwidth power ratings support 100 Hz - 20 kHz due to automatic high-pass filters.

7 Specifications

The following specifications apply to all models in Dual 8/4 ohm mode with 8-ohm loads unless otherwise specified.

Performance	CTs 4200	CTs 8200
Frequency Response (at 1 watt, 20 Hz - 20 kHz)	± 0.5 dB	± 0.5 dB
Phase Response (at 1 watt, 10 Hz - 20 kHz)	± 35°	± 35°
Signal to Noise Ratio below rated power (20 Hz to 20 kHz)	100 dB unweighted	100 dB unweighted
Total Harmonic Distortion (THD) at 1 watt, from 20 Hz to 20 kHz	< 0.05%	< 0.05%
Intermodulation Distortion (IMD) 60 Hz and 7 kHz at 4:1, from 163 milliwatts to full bandwidth power, typical	< 0.05%	< 0.05%
Damping Factor: 10 Hz to 400 Hz	>180	>180
Crosstalk (below rated power, 20 Hz to 1 kHz)	> 80 dB	> 80 dB
Common Mode Rejection (CMR) (20 Hz to 1 kHz)	> 50 dB	> 50 dB
DC Output Offset (Shorted input)	< ± 5 mV	< ± 5 mV
Input Impedance nominally balanced, nominally unbalanced	20 kilohms, 10 kilohms	20 kilohms, 10 kilohms
Maximum Input Level (before input compression)	+ 20 dBu	+ 20 dBu
Load Impedance (Note: Safe with all types of loads)		
Stereo	4/8 and 25 ohms (70V)	4/8 and 25 ohms (70V)
Bridge Mono	8/16 and 50 ohms (100V)	8/16 and 50 ohms(100V)
Voltage Gain (at maximum level setting), 1.4V sensitivity		
4/8 Ohm Operation	20:1 (26 dB)	20:1 (26 dB)
70V Operation	50:1 (34 dB)	50:1 (34 dB)
100V Operation	71.4:1 (37 dB)	71.4:1 (37 dB)
Required AC Mains (model dependent)	120V, 60 Hz. 220/230/240V, 50 Hz	100V, 50/60Hz. 120V, 60 Hz. 220/230/240V, 50 Hz
Power Draw at Idle (120VAC mains, all channels in 4/8 ohm mode)	70W	70W
Power Draw at Idle (120VAC mains, all channels in 70V mode)	114W	114W
Cooling	Continuously variable speed forced air, front-to-back airflow	Continuously variable speed forced air, front-to-back airflow
Dimensions: Width, Height, Depth	19 in. (48.3 cm) W x 3.5 in. (8.9 cm) H x 16.25 in. (41.3 cm) D	19 in. (48.3 cm) W x 5.25 in. (13.3 cm) H x 16.25 in. (41.3 cm) D
Net Weight, Shipping Weight	26 lb. 6 oz. (12 kg), 30 lb. 14 oz. (14 kg)	36 lb. 6 oz. (16.5 kg), 47 lb. (21.3 kg)

7 Specifications

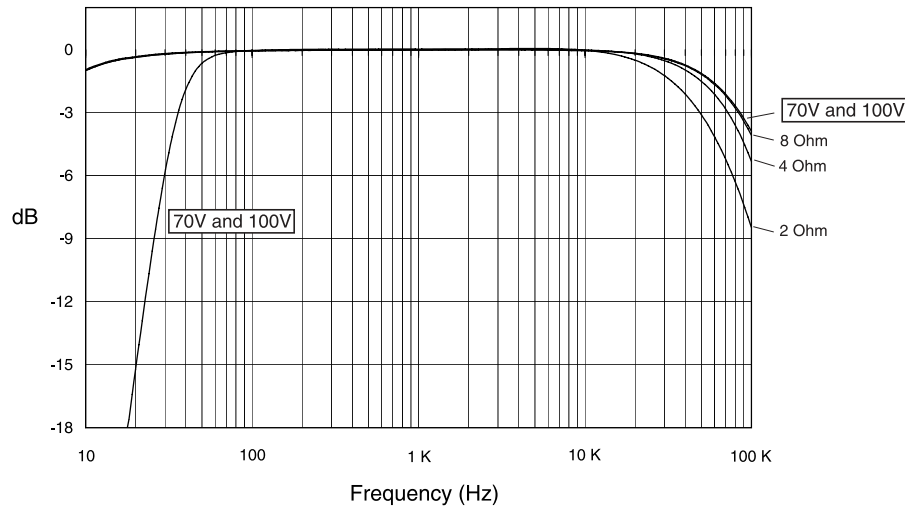

Figure 7.3 CTs 8200 Typical Frequency Response (1 W)

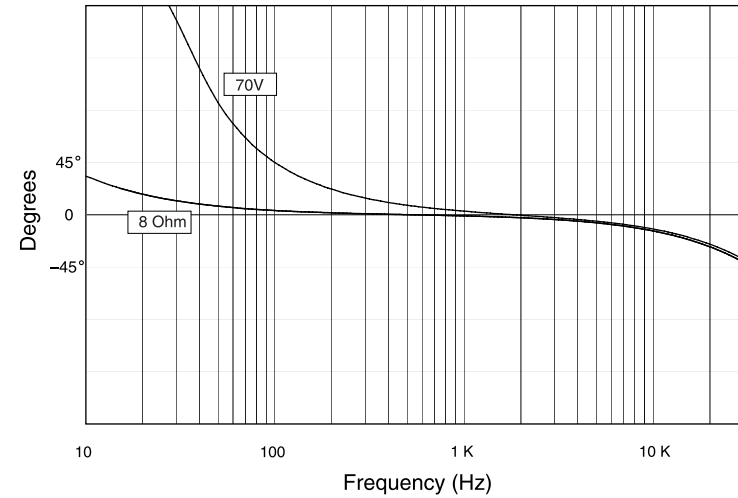

Figure 7.4 CTs 8200 Typical Phase Response (1 W)

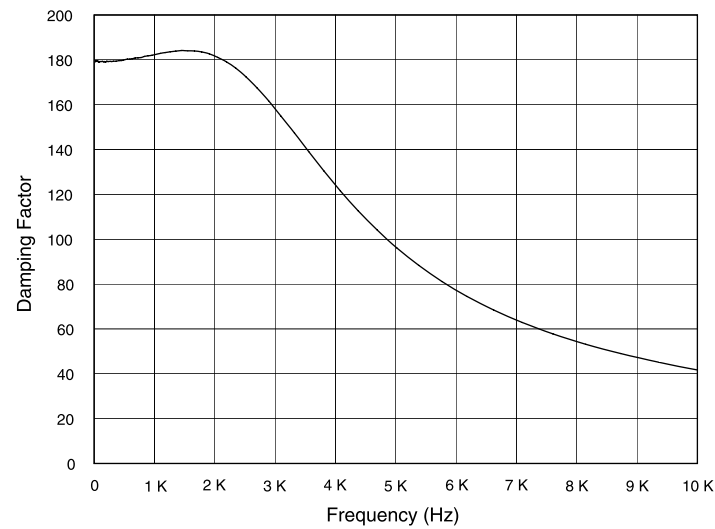

Figure 7.5 CTs 8200 Typical Damping Factor vs. Frequency

7 Specifications

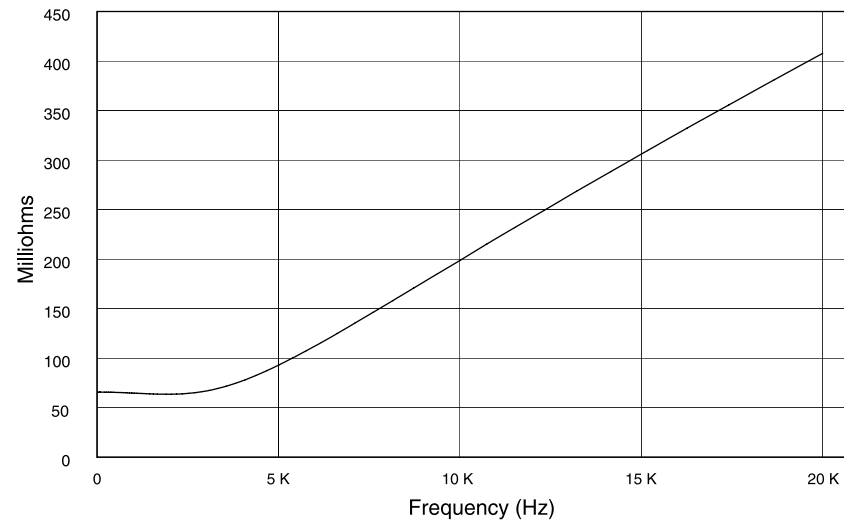

Figure 7.6 CTs 8200 Typical Output Impedance vs. Frequency

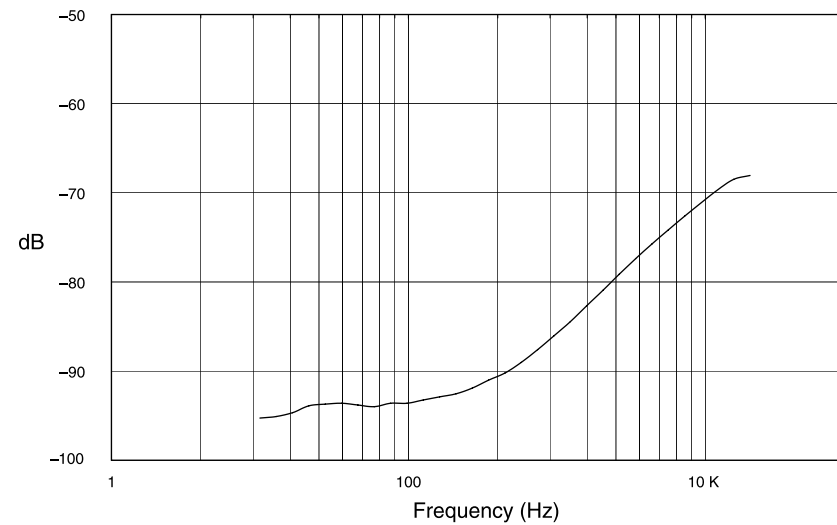

Figure 7.7 CTs 8200 Typical Crosstalk vs. Frequency

8 AC Power Draw and Thermal Dissipation

AC Power Draw and Thermal Dissipation:

Pink noise 12dB crest factor, bandwidth limited 22Hz to 22kHz.

Typical line impedance used.

Measurements made with 120VAC mains. Line current figures for 230VAC units derived by multiplying 120VAC figures by 0.5.

Data based on all channels driven.

CTs 4200									
	Load	Rated Power	Line Current 120VAC	Line Current 230VAC	Watts			Thermal Dissipation	
					watts in	watts out	dissipated	Btu/hr	kcal/hr
At Idle (8.4 Ohm mode)					70	0	70	239	60
At Idle (70/100V mode)					114	0	114	389	98
1/8th Power Pink Noise Typical of program material just at clip.	8 Ohms/Ch. 16 Ohms Bridge	200x4 400x2	5.2	2.6	400	99	301	1027	259
	4 Ohms/Ch. 8 Ohms Bridge	260x4 520x2							
	70V/Ch. 100V Bridge	220x4	5.3	2.7	427	110	318	1084	273
		220x2							
1/3rd Power Pink Noise Typical of program material with severe clipping.	8 Ohms/Ch. 16 Ohms Bridge	200x4 400x2	7.6	3.8	648	257	391	1336	337
	4 Ohms/Ch. 8 Ohms Bridge	260x4 520x2							
	70V/Ch. 100V Bridge	220x4	7.9	4.0	668	286	382	1303	329
		220x2							

8 AC Power Draw and Thermal Dissipation

AC Power Draw and Thermal Dissipation:

Pink noise 12dB crest factor, bandwidth limited 22Hz to 22kHz.

Typical line impedance used.

Measurements made with 120VAC mains. Line current figures for 230VAC units derived by multiplying 120VAC figures by 0.5.

Data based on all channels driven.

CTs 8200									
	Load	Rated Power	Line Current 120VAC	Line Current 230VAC	Watts			Thermal Dissipation	
					watts in	watts out	dissipated	Btu/hr	kcal/hr
At Idle (8.4 Ohm mode)					70	0	70	239	60
At Idle (70/100V mode)					114	0	114	389	98
1/8th Power Pink Noise Typical of program material just at clip.	8 Ohms/Ch. 16 Ohms Bridge	160x8 320x4	8.7	4.3	725	172	553	1889	476
	4 Ohms/Ch. 8 Ohms Bridge	200x8 400x4							
	70V/Ch. 100V Bridge	200x8	10.1	5.1	857	203	653	2230	562
		200x4							
1/3rd Power Pink Noise Typical of program material with severe clipping.	8 Ohms/Ch. 16 Ohms Bridge	160x8 320x4	13.1	6.5	1136	437	699	2385	601
	4 Ohms/Ch. 8 Ohms Bridge	200x8 400x4							
	70V/Ch. 100V Bridge	200x8	15.3	7.7	1344	552	792	2702	681
		200x4							

9 Service

Crown amplifiers are quality units that rarely require servicing. Before returning your unit for service, please contact Crown Technical Support to verify the need for servicing.

This unit has very sophisticated circuitry which should only be serviced by a fully trained technician. This is one reason why each unit bears the following label:

CAUTION: To prevent electric shock, do not remove covers. No user serviceable parts inside. Refer servicing to a qualified technician.



Complete the Crown Audio Factory Service Information form, in the back of this manual, when returning a Crown product to the factory or authorized service center. The form must be included with your product inside the box or in a packing slip envelope securely attached to the outside of the shipping carton. Do not send this form separately.

9.1 International and Canada Service

Service may be obtained from an authorized service center. (Contact your local Crown/Amcron representative or our office for a list of authorized service centers.) To obtain service, simply present the bill of sale as proof of purchase along with the defective unit to an authorized service center. They will handle the necessary paperwork and repair.

Remember to transport your unit in the original factory pack.

9.2 US Service

Service may be obtained in one of two ways: from an authorized service center or from the factory. You may choose either. It is important that you have your copy of the bill of sale as your proof of purchase.

9.2.1 Service at a US Service Center

This method usually saves the most time and effort. Simply present your bill of sale along with the defective unit to an authorized service center to obtain service. They will handle the necessary paperwork and repair. Remember to transport the unit in the original factory pack. A list of authorized service centers in your area can be obtained from Crown Factory Service, or online from <http://www.crownaudio.com/support/servcent.htm>.

9.2.2 Factory Service

Crown accepts no responsibility for non-serviceable product that is sent to us for factory repair. It is the owner's responsibility to ensure that their product is serviceable prior to sending it to the factory. Serviceable product list is available at <http://crownweb.crownintl.com/crownrma/>. For more information, please contact us direct.

A Service Return Authorization (SRA) is required for product being sent to the factory for repair. An SRA can be completed online at www.crownaudio.com/support/factserv.htm. If you do not have access to the web, please call Crown's Customer Service at 574.294.8200 or 800.342.6939 extension 8205.

For warranty service, we will pay for ground shipping both ways in the United States. Contact Crown Customer Service to obtain prepaid shipping labels prior to sending the unit. Or, if you prefer, you may prepay the cost of shipping, and Crown will reimburse you. Send copies of the shipping receipts to Crown to receive reimbursement. Your repaired unit will be returned via UPS ground. Please contact us if other arrangements are required.

9.2.3 Factory Service Shipping Instructions:

1. Service Return Authorization (SRA) is required for product being sent to the factory for service. Please complete the SRA by going to www.crownaudio.com/support/factserv.htm. If you do not have access to our website, call 1.800.342.6939, extension 8205 and we'll create the SRA for you.
2. See packing instructions that follow.
3. Ship product to:
CROWN AUDIO FACTORY SERVICE
1718 W MISHAWKA RD.
ELKHART, IN 46517
4. Use a bold black marker and write the SRA number on three sides of the box.
5. Record the SRA number for future reference. The SRA number can be used to check the repair status.

9.2.4 Packing Instructions

Important: These instructions must be followed. If they are not followed, Crown Audio, Inc. assumes no responsibility for damaged goods and/or accessories that are sent with your unit.

1. Fill out and include the Crown Audio Factory Service Information sheet in the back of this manual.
2. Do not ship any accessories (manuals, cords, hardware, etc.) with your unit. These items are not needed to service your product. We will not be responsible for these items.
3. When shipping your Crown product, it is important that it has adequate protection. We recommend you use the original pack material when returning the product for repair. If you do not have the original box, please call Crown at 800.342.6939 or 574.294.8210 and order new pack material. See instructions for "foam-in-place" shipping pack. (Do not ship your unit in a wood or metal cabinet.)
4. If you provide your own shipping pack, the minimum recommended requirements for materials are as follows:

- a. 275 P.S.I. burst test, Double-Wall carton that allows for 2-inch solid Styrofoam on all six sides of unit or 3 inches of plastic bubble wrap on all six sides of unit.
- b. Securely seal the package with an adequate carton sealing tape.
- c. Do not use light boxes or "peanuts". Damage caused by poor packaging will not be covered under warranty.

Using your 'foam-in-place' shipping pack

Note: The foam-in-place packing is molded so that there is only one correct position for your product.

1. Open carton and lift center cushion leaving both end-cushions in place.
2. Carefully place your product with the product's front panel facing the same direction as arrows indicate.

3. Reset center cushion down over top of product's chassis. The foam-in-place packing was molded to accommodate different chassis depth sizes. If your product's chassis does not completely fill the foam-in-place cavity, you may use a soft but solid packing material (such as paper or bubble wrap) behind the chassis.
4. Enclose the completed Crown Audio Factory Service Information form (or securely attach it to the outside of carton) and re-seal the shipping pack with a sturdy carton sealing tape.

9.2.5 Estimate Approval

Approval of estimate must be given within 90 days after being notified by Crown Audio Inc. Units still in the possession of Crown after 90 days of the estimate will become the property of Crown Audio Inc.

9.2.6 Payment of Non-Warranty Repairs

Payment on out-of-warranty repairs must be received within 90 days of the repair date. Units unclaimed after 90 days become the property of Crown Audio Inc.

If you have any questions, please contact Crown Factory Service.

Crown Factory Service
1718 W. Mishawaka Rd.,
Elkhart, Indiana 46517 U.S.A.

Telephone:
574.294.8200
800.342.6939 (North America,
Puerto Rico, and Virgin Islands only)

Facsimile:
574.294.8301 (Technical Support)
574.294.8124 (Factory Service)

Internet:
<http://www.crownaudio.com>

10 Warranty



UNITED STATES & CANADA

SUMMARY OF WARRANTY

Crown International, 1718 West Mishawaka Road, Elkhart, Indiana 46517-4095 U.S.A. warrants to you, the ORIGINAL PURCHASER and ANY SUBSEQUENT OWNER of each NEW Crown product, for a period of three (3) years from the date of purchase by the original purchaser (the "warranty period") that the new Crown product is free of defects in materials and workmanship. We further warrant the new Crown product regardless of the reason for failure, except as excluded in this Warranty.

ITEMS EXCLUDED FROM THIS CROWN WARRANTY

This Crown Warranty is in effect only for failure of a new Crown product which occurred within the Warranty Period. It does not cover any product which has been damaged because of any intentional misuse, accident, negligence, or loss which is covered under any of your insurance contracts. This Crown Warranty also does not extend to the new Crown product if the serial number has been defaced, altered, or removed.

WHAT THE WARRANTOR WILL DO

We will remedy any defect, regardless of the reason for failure (except as excluded), by repair, replacement, or refund. We may not elect refund unless you agree, or unless we are unable to provide replacement, and repair is not practical or cannot be timely made. If a refund is elected, then you must make the defective or malfunctioning product available to us free and clear of all liens or other encumbrances. The refund will be equal to the actual purchase price, not including inter-

est, insurance, closing costs, and other finance charges less a reasonable depreciation on the product from the date of original purchase. Warranty work can only be performed at our authorized service centers or at the factory. Warranty work for some products can only be performed at our factory. We will remedy the defect and ship the product from the service center or our factory within a reasonable time after receipt of the defective product at our authorized service center or our factory. All expenses in remedying the defect, including surface shipping costs in the United States, will be borne by us. (You must bear the expense of shipping the product between any foreign country and the port of entry in the United States including the return shipment, and all taxes, duties, and other customs fees for such foreign shipments.)

HOW TO OBTAIN WARRANTY SERVICE

You must notify us of your need for warranty service within the warranty period. All components must be shipped in a factory pack, which, if needed, may be obtained from us free of charge. Corrective action will be taken within a reasonable time of the date of receipt of the defective product by us or our authorized service center. If the repairs made by us or our authorized service center are not satisfactory, notify us or our authorized service center immediately.

DISCLAIMER OF CONSEQUENTIAL AND INCIDENTAL DAMAGES

YOU ARE NOT ENTITLED TO RECOVER FROM US ANY INCIDENTAL DAMAGES RESULTING

FROM ANY DEFECT IN THE NEW CROWN PRODUCT. THIS INCLUDES ANY DAMAGE TO ANOTHER PRODUCT OR PRODUCTS RESULTING FROM SUCH A DEFECT. SOME STATES DO NOT ALLOW THE EXCLUSION OR LIMITATIONS OF INCIDENTAL OR CONSEQUENTIAL DAMAGES, SO THE ABOVE LIMITATION OR EXCLUSION MAY NOT APPLY TO YOU.

WARRANTY ALTERATIONS

No person has the authority to enlarge, amend, or modify this Crown Warranty. This Crown Warranty is not extended by the length of time which you are deprived of the use of the new Crown product. Repairs and replacement parts provided under the terms of this Crown Warranty shall carry only the unexpired portion of this Crown Warranty.

DESIGN CHANGES

We reserve the right to change the design of any product from time to time without notice and with no obligation to make corresponding changes in products previously manufactured.

LEGAL REMEDIES OF PURCHASER

THIS CROWN WARRANTY GIVES YOU SPECIFIC LEGAL RIGHTS, YOU MAY ALSO HAVE OTHER RIGHTS WHICH VARY FROM STATE TO STATE. No action to enforce this Crown Warranty shall be commenced after expiration of the warranty period.

THIS STATEMENT OF WARRANTY SUPERSEDES ANY OTHERS CONTAINED IN THIS MANUAL FOR CROWN PRODUCTS. 12/01

10 Warranty



WORLDWIDE EXCEPT USA & CANADA

SUMMARY OF WARRANTY

Crown International, 1718 West Mishawaka Road, Elkhart, Indiana 46517-4095 U.S.A. warrants to you, the ORIGINAL PURCHASER and ANY SUBSEQUENT OWNER of each NEW Crown1 product, for a period of three (3) years from the date of purchase by the original purchaser (the "warranty period") that the new Crown product is free of defects in materials and workmanship, and we further warrant the new Crown product regardless of the reason for failure, except as excluded in this Warranty.

¹ Note: If your unit bears the name "Amcron," please substitute it for the name "Crown" in this warranty.

ITEMS EXCLUDED FROM THIS CROWN-WARRANTY

This Crown Warranty is in effect only for failure of a new Crown product which occurred within the Warranty Period. It does not cover any product which has been damaged because of any intentional misuse, accident, negligence, or loss which is covered under any of your insurance contracts. This Crown Warranty also does not extend to the new Crown product if the serial number has been defaced, altered, or removed.

WHAT THE WARRANTOR WILL DO

We will remedy any defect, regardless of the reason for failure (except as excluded), by repair, replacement, or refund. We may not elect refund

unless you agree, or unless we are unable to provide replacement, and repair is not practical or cannot be timely made. If a refund is elected, then you must make the defective or malfunctioning product available to us free and clear of all liens or other encumbrances. The refund will be equal to the actual purchase price, not including interest, insurance, closing costs, and other finance charges less a reasonable depreciation on the product from the date of original purchase. Warranty work can only be performed at our authorized service centers. We will remedy the defect and ship the product from the service center within a reasonable time after receipt of the defective product at our authorized service center.

HOW TO OBTAIN WARRANTY SERVICE

You must notify your local Crown importer of your need for warranty service within the warranty period. All components must be shipped in the original box. Corrective action will be taken within a reasonable time of the date of receipt of the defective product by our authorized service center. If the repairs made by our authorized service center are not satisfactory, notify our authorized service center immediately.

DISCLAIMER OF CONSEQUENTIAL AND INCIDENTAL DAMAGES

YOU ARE NOT ENTITLED TO RECOVER FROM US ANY INCIDENTAL DAMAGES RESULTING FROM ANY DEFECT IN THE NEW CROWN PRODUCT. THIS INCLUDES ANY DAMAGE TO ANOTHER PRODUCT OR PRODUCTS RESULTING FROM SUCH A DEFECT.

WARRANTY ALTERATIONS

No person has the authority to enlarge, amend, or modify this Crown Warranty. This Crown Warranty is not extended by the length of time which you are deprived of the use of the new Crown product. Repairs and replacement parts provided under the terms of this Crown Warranty shall carry only the unexpired portion of this Crown Warranty.

DESIGN CHANGES

We reserve the right to change the design of any product from time to time without notice and with no obligation to make corresponding changes in products previously manufactured.

LEGAL REMEDIES OF PURCHASER

No action to enforce this Crown Warranty shall be commenced after expiration of the warranty period.

THIS STATEMENT OF WARRANTY SUPERSEDES ANY OTHERS CONTAINED IN THIS MANUAL FOR CROWN PRODUCTS. 7/01

NOTES



Crown Audio Factory Service Information

Shipping Address: Crown Audio Factory Service, 1718 W. Mishawaka Rd., Elkhart, IN 46517

PLEASE PRINT CLEARLY

SRA #: _____ (If sending product to Crown factory service.) Model: _____ Serial Number: _____ Purchase Date: _____

PRODUCT RETURN INFORMATION

Individual or Business Name: _____

Phone #: _____ Fax #: _____ E-Mail: _____

Street Address (please, no P.O. Boxes): _____

City: _____ State/Prov: _____ Postal Code: _____ Country: _____

Nature of problem: _____

Other equipment in your system: _____

If warranty is expired, please provide method of payment. Proof of purchase may be required to validate warranty.

PAYMENT OPTIONS

I have open account payment terms. Purchase order required. PO#: _____ COD

Credit Card (Information below is required; however if you do not want to provide this information at this time, we will contact you when your unit is repaired for the information.)

Credit card information:

Type of credit card: MasterCard Visa American Express Discover

Type of credit card account: Personal/Consumer Business/Corporate

Card # _____ Exp. date: _____ * Card ID #: _____

* Card ID # is located on the back of the card following the credit card #, in the signature area. On American Express, it may be located on the front of the card. This number is required to process the charge to your account. If you do not want to provide it at this time, we will call you to obtain this number when the repair of your unit is complete.

Name on credit card: _____

Billing address of credit card: _____

THIS PAGE INTENTIONALLY LEFT BLANK

THIS PAGE INTENTIONALLY LEFT BLANK



H A Harman International Company

Free Manuals Download Website

<http://myh66.com>

<http://usermanuals.us>

<http://www.somanuals.com>

<http://www.4manuals.cc>

<http://www.manual-lib.com>

<http://www.404manual.com>

<http://www.luxmanual.com>

<http://aubethermostatmanual.com>

Golf course search by state

<http://golfingnear.com>

Email search by domain

<http://emailbydomain.com>

Auto manuals search

<http://auto.somanuals.com>

TV manuals search

<http://tv.somanuals.com>