

Amplifier Application Guide



© 2006 by Crown Audio® Inc., 1718 W. Mishawaka Rd., Elkhart, IN 46517-9439 U.S.A.
Telephone: 574-294-8000. Fax: 574-294-8329.

www.crownaudio.com

Trademark Notice: Amcron®, BCA®, and Crown®, Crown Audio, IOC®, IQ System®, ODEP® and VZ® are registered trademarks and Grounded Bridge™, PIP™ and PIP2™ are trademarks of Crown Audio, Inc.

Other trademarks are the property of their respective owners.

H A Harman International Company

133472-1A

1/06

The information furnished in this manual does not include all of the details of design, production, or variations of the equipment. Nor does it cover every possible situation which may arise during installation, operation or maintenance. If you need special assistance beyond the scope of this manual, please contact our Technical Support Group.

Crown Technical Support Group

1718 W. Mishawaka Rd., Elkhart, Indiana 46517 U.S.A.

DANGER: This amplifier can produce lethal levels of output power! Be very careful when making connections. Do not attempt to change the output wiring unless AC power has been removed from the amplifier for at least

WARNING: This unit is capable of producing very high sound pressure levels. Continuous exposure to high sound pressure levels can cause permanent hearing impairment or loss. Caution is advised and ear protection recommended when playing at high volumes.

Important Safety Instructions

- 1) Read these instructions.
- 2) Keep these instructions.
- 3) Heed all warnings.
- 4) Follow all instructions.
- 5) Do not use this apparatus near water.
- 6) Clean only with a dry cloth.
- 7) Do not block any ventilation openings. Install in accordance with the manufacturer's instructions.
- 8) Do not install near any heat sources such as radiators, heat registers, stoves, or other apparatus that produce heat.
- 9) Do not defeat the safety purpose of the polarized or grounding-type plug. A polarized plug has two blades with one wider than the other. A grounding-type plug has two blades and a third grounding prong. The wide blade or the third prong is provided for your safety. If the provided plug does not fit into your outlet, consult an electrician for replacement of the obsolete outlet.
- 10) Protect the power cord from being walked on or pinched, particularly at plugs, convenience receptacles, and the point where they exit from the apparatus.
- 11) Only use attachments/accessories specified by the manufacturer.
- 12) Use only with a cart, stand, bracket, or table specified by the manufacturer, or sold with the apparatus. When a cart is used, use caution when moving the cart/apparatus combination to avoid injury from tip-over.
- 13) Unplug this apparatus during lightning storms or when unused for long periods of time.
- 14) Refer all servicing to qualified service personnel. Servicing is required when the apparatus has been damaged in any way, such as power-supply cord or plug is damaged, liquid has been spilled or objects have fallen into the apparatus, the apparatus has been exposed to rain or moisture, does not operate normally, or has been dropped.



CAUTION
RISK OF ELECTRIC SHOCK
DO NOT OPEN

TO PREVENT ELECTRIC SHOCK DO NOT REMOVE TOP OR BOTTOM COVERS. NO USER SERVICEABLE PARTS INSIDE. REFER SERVICING TO QUALIFIED SERVICE PERSONNEL.

AVIS
RISQUE DE CHOC ÉLECTRIQUE
N'OUVREZ PAS

À PRÉVENIR LE CHOC ÉLECTRIQUE N'ENLEVEZ PAS LES COUVERCLES. IL N'Y A PAS DES PARTIES SERVICEABLE À L'INTÉRIEUR. TOUS REPARATIONS DOIT ÊTRE FAIRE PAR PERSONNEL QUALIFIÉ SEULMENT.



The lightning bolt triangle is used to alert the user to the risk of electric shock.



The exclamation point triangle is used to alert the user to important operating or maintenance instructions.



Table of Contents

Introduction.....	4
Chapter 1: Crown Amplifiers In-Depth.....	5
1.1 Rack Cooling	5
1.1.1 Fan-Assisted Models.....	5
1.1.2 Convection-Only Models	6
1.2 System Wiring	7
1.2.1 Input Wiring	7
Input Connector Wiring	7
Balanced, Grounded Source	7
Balanced, Floating Source	7
Unbalanced, Grounded Source, Twin-Lead Shielded Cable	8
Unbalanced, Floating Source, Twin-Lead Shielded Cable	8
Unbalanced, Grounded Source, Single-Conductor Coax or Twisted-Pair Cable	8
Unbalanced, Floating Source, Single-Conductor Coax or Twisted-Pair Cable	8
1.2.2 Solving Input Problems	9
1.3 Output Wiring	10
1.3.1 Output Connector Wiring.....	10
5-Way Binding Post	10
Barrier Block.....	11
Neutrik® Speakon®	11
1.3.2 Amplifier Load Impedance	13
1.3.3 Determining Appropriate Speaker Wire Gauge.....	14
1.3.4 Loudspeaker Protection	15
1.3.5 Solving Output Problems	16
High-Frequency Oscillations	16
Sub-Sonic Currents.....	16
1.3.6 Distributed Speaker Systems.....	17
What is Constant Voltage?	17
Transformer Saturation.....	17
1.4 Multi-way Systems (with Expansion Modules)	18
1.4.1 Active vs. Passive Crossover Networks	18
1.5 Fault Monitoring	20
1.6 Setting System Gain Structure.....	21
1.6.1 System Levels.....	21
1.6.2 Amplifier Level.....	21
Chapter 2: Troubleshooting	23
2.1 No Power.....	24
2.2 No Sound	25
2.3 Bad Sound	26
2.4 Amp Overheating	26
Chapter 3: Glossary of Terms.....	27
Appendix: Suggested Reading	33



Introduction

This application guide provides useful information designed to help you best use your new *Crown*[®] amplifier. It is designed to complement your amplifier's *Operation Manual*, which describes the specific features and specifications of your amplifier. Helpful guides and tips on subjects such as system wiring and system gain structure, for example, should be helpful to you whether you are a beginner or a seasoned professional. You can choose to read this guide from cover to cover, or if you are already familiar with Crown amps, you can jump to specific sections as needed. A glossary of terms and list of suggested publications for further reading are also provided for your convenience.

Please be sure to read all instructions, warnings and cautions.

For your protection, please send in the warranty registration card today. And save your bill of sale—it's your official proof of purchase.

Chapter 1

Crown Amplifiers In-Depth

In This Chapter

- Rack Cooling
- System Wiring
- Amplifier Load Impedance
- Multi-Way Systems
- Distributed Speaker Systems
- Setting System Gain Structure

This chapter provides information to help you get optimum performance from your Crown amplifier. It is a collection of techniques that can help you avoid many of the common problems that plague sound systems. For further study on many of these topics, refer to the recommended publications listed in the Appendix.

1.1 Rack Cooling

When installing your Crown amp in a rack, you should take steps to make sure that the temperature of the rack stays in a safe range. Crown amps with fan-assisted cooling and convection-only cooling may require different techniques for best performance.

When designing your rack cooling system, you should consider the requirements for all mounted components.

1.1.1 Fan-Assisted Models

If your Crown amplifier uses fan-assisted cooling, make sure that the front vents and/or filters are never blocked, and that the exhaust fan (vented out the back or

Figure 1.1
Top View of Rack-Mounted Amplifier with Side Vents

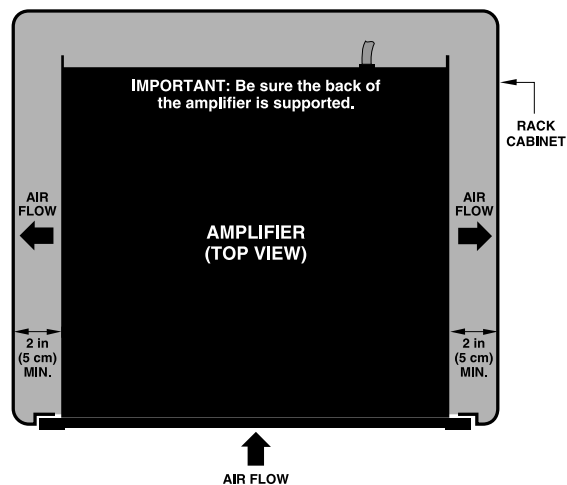

sides) is not blocked or covered by cables. Also, if your Crown amp has foam filters, they can be cleaned with mild dish detergent and water when needed.

The side walls of the rack should be at least 2 inches (5 cm) away from the chassis for amps with side venting as shown in Figure 1.1.

Don't use vented spacer panels between amps in a rack. Because of the airflow technology we use in our amps, it is best to stack multiple amplifiers on top of each other with no space between.

The amplifier draws fresh air into the front of the amp and exhausts it either out the sides and into the rack, or out the back depending on the model. We want the hot air that's in the rack to vent out the sides or back—not the front. If any of these amplifiers are spaced apart with vented panels, some of the preheated air will recycle to the front of the rack and back into the amplifier. The result is loss of thermal headroom. If you choose to place the amplifiers with space between them, then use solid panels between them, not vented panels.

You should provide adequate airflow within the rack. Additional air flow may be required when driving low impedance loads at consistently high output levels or for higher power models. Refer to your Crown amplifier's *Operation Manual* for detailed information on thermal dissipation.

If your rack has a front door that could block air flow to the amplifier's air intakes, you must provide adequate air flow by installing a grille in the door or by pressurizing the air behind the door. Wire grilles are recommended over perforated panels because they tend to cause less air restriction. A good choice for pressurizing the air behind a rack cabinet door is to mount a "squirrel cage" blower inside the rack (Option 1 in Figure 1.2). At the bottom of the rack, mount the blower so it blows outside air into the space between the door and in front of the amplifiers, pressurizing the "chimney" behind the door. This blower should not blow air into or take air out of the space behind the amplifiers. For racks without a door, you can evacuate the rack by mounting the blower at the top of the rack so that air inside the cabinet is drawn out the back (Option 2 in Figure 1.2).

If the air supply is unusually dusty, you might want to pre-filter it using commercial furnace filters to prevent rapid loading of the unit's own air filter.

1.1.2 Convection-Only Models

When racking convection-cooled amplifiers, it is best to leave one rack-space between amps because this type of amplifier needs space to radiate the heat.

Overheating

Because of the wide range of operating conditions your amplifier might be subjected to in the field, you should consider each installation independently to ensure the best thermal performance. If your amp starts to overheat, consider the following possible causes:

1. Insufficient air movement.
2. Overdriving of the input stage (severely into clip).
3. Very low-impedance loads.
4. High ambient temperatures.

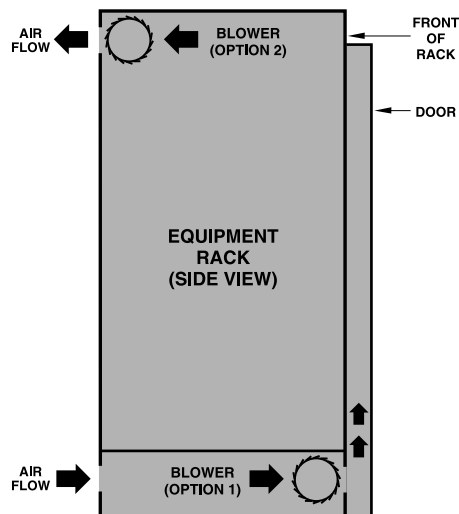

Figure 1.2
Extra Cooling with a
Rack-Mounted Blower

1.2 System Wiring

The information in this section covers making input and output wiring connections, as well as troubleshooting problems relating to system wiring.

1.2.1 Input Wiring

Input Connector Wiring

Refer to the following diagrams for input cable wiring for commonly-used connector types.

Note: These diagrams follow the AES wiring convention of Pin 2 = hot for XLR connectors.

Balanced, Grounded Source

For use with components equipped with three-wire grounded AC line cord or other ground connection.

Balanced, Floating Source

For use with components equipped with two-wire AC line cord or battery power.

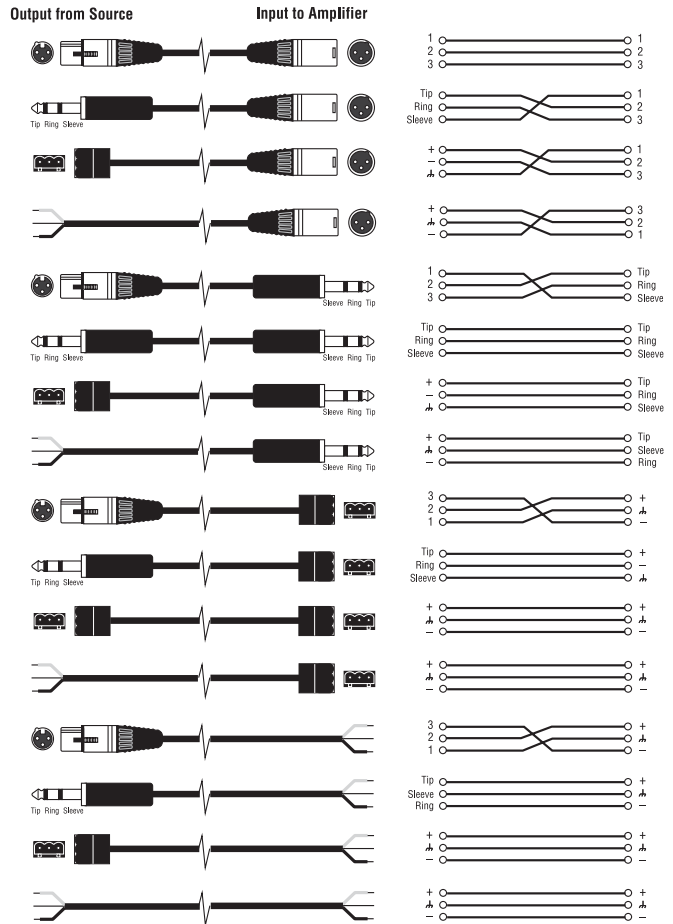
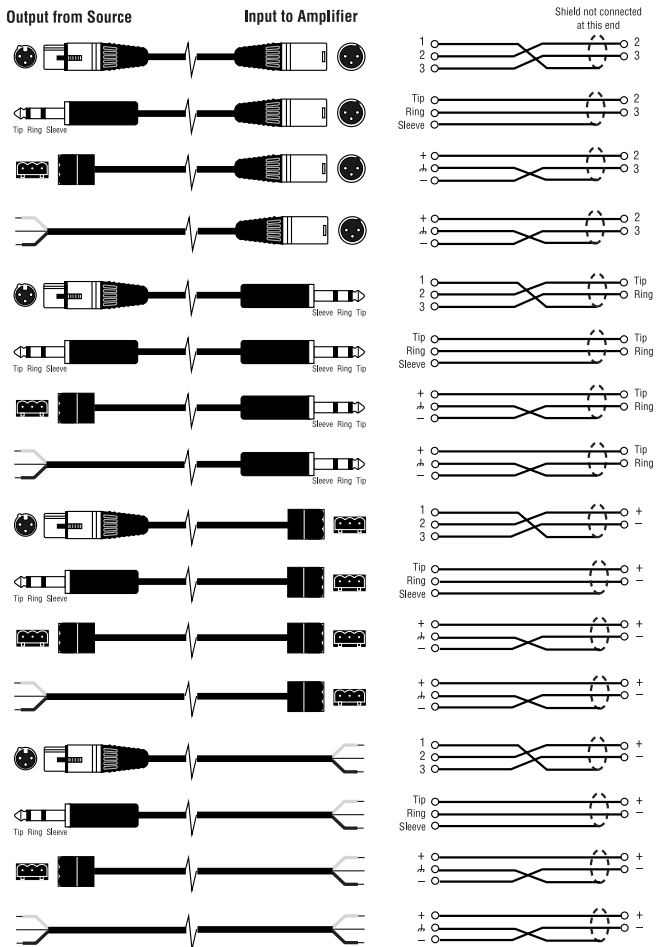

Note: If two or more channels with the same input ground reference are driven from the same floating source, connect only one shield to the source chassis

Unbalanced, Grounded Source, Twin-Lead Shielded Cable

For use with components equipped with three-wire grounded AC line cord or other ground connection.

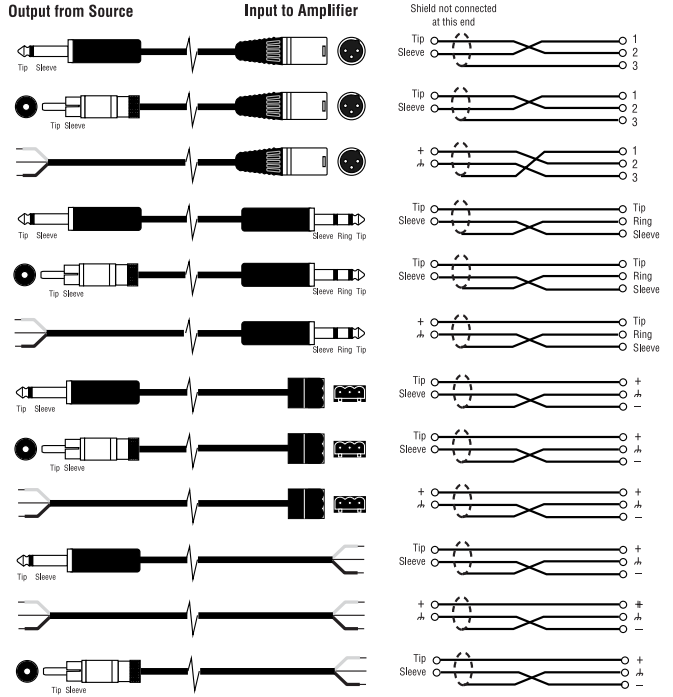

Unbalanced, Floating Source, Twin-Lead Shielded Cable

For use with components equipped with two-wire AC line cord or battery power.

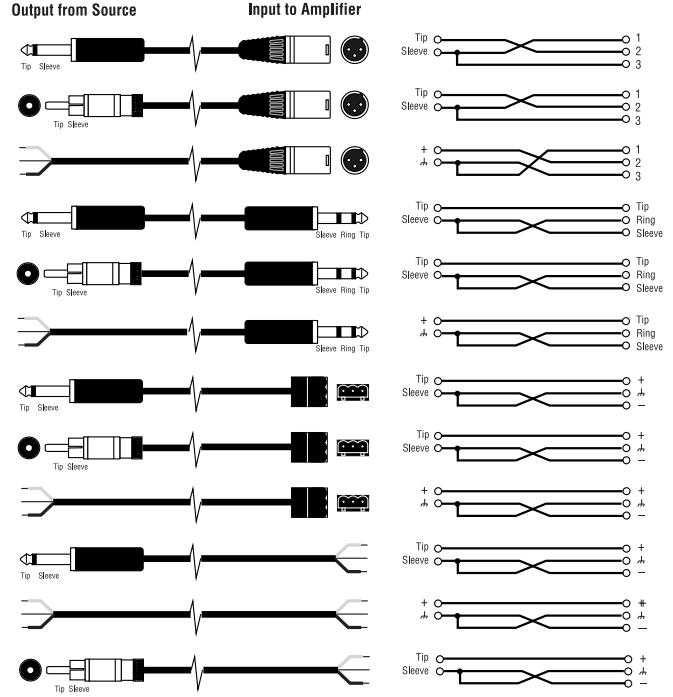

Unbalanced, Grounded Source, Single-Conductor Coax or Twisted-Pair Cable

For use with components equipped with three-wire grounded AC line cord or other ground connection.

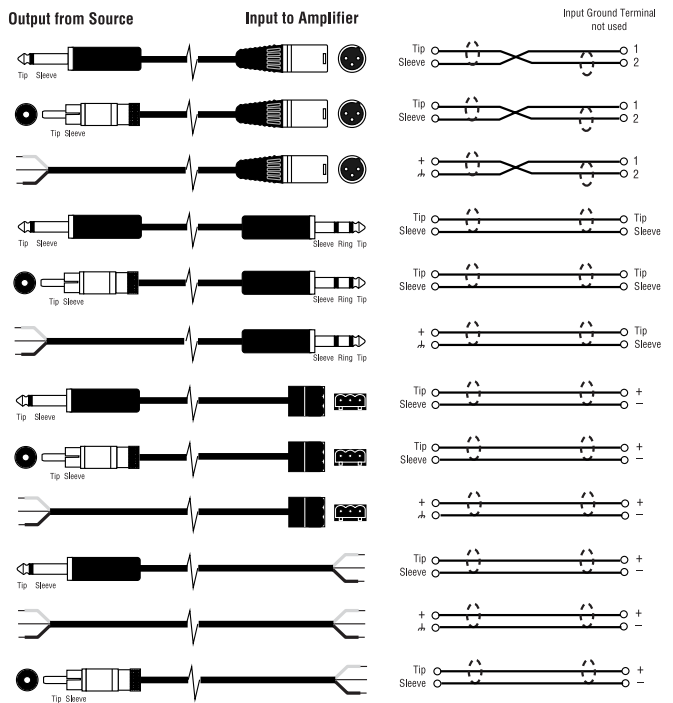

Unbalanced, Floating Source, Single-Conductor Coax or Twisted-Pair Cable

For use with components equipped with two-wire AC line cord or battery power.

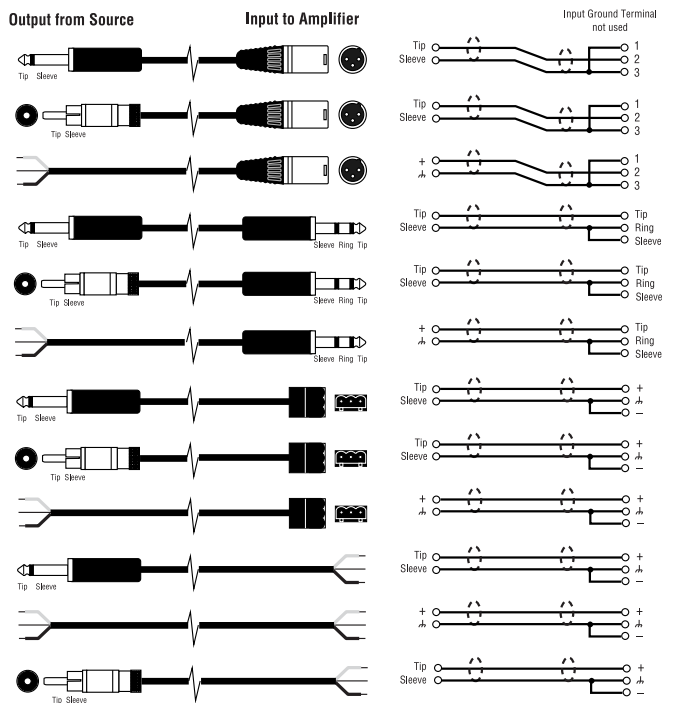

Input Wiring Tips

1. For all input connectivity, use shielded wire only. Cables with a foil wrap shield or a high-density braid are superior. Cables with a stranded spiral shield, although very flexible, will break down over time and cause noise problems.
2. Try to avoid using unbalanced lines with professional equipment. If you have no choice, keep the cables as short as possible (see “Balanced vs. Unbalanced” on the next page).
3. To minimize hum and crosstalk, avoid running low-level input cables, high-level output wires and AC power feeds in the same path. Try to run differing signal-cable paths at 90°

to one another. If you must use a common path for all cables, use a star-quad cable for the low-level signals.

4. Before changing input connectors or wiring, turn the amplifier level controls all the way down (counter-clockwise).
5. Before changing output connections, turn the amplifier level down and the AC power off to minimize the chance of short-circuiting the output.

1.2.2 Solving Input Problems Infrasonic (Subaudible) Frequencies

Sometimes large infrasonic (sub-audible) frequencies are present in the input signal. These can damage loudspeakers by overloading or overheating them. To attenuate such frequencies, place a capacitor in series with the input signal line. The graph in Figure 1.3 shows some capacitor values and how they affect the frequency response. Use only low-leakage paper, mylar or tantalum capacitors.

Radio Frequencies (RF)

Another problem to avoid is the presence of large levels of radio frequencies or RF in the input signal. Although high RF levels may not pose a threat to the amplifier, they can burn out tweeters or other loads that are sensitive to high frequencies. Extremely high RF levels can also cause your amplifier to prematurely activate its protection circuitry, resulting in inefficient operation. RF can be introduced into the signal chain from many sources such as

Figure 1.3
Subsonic Filter Capacitor Values

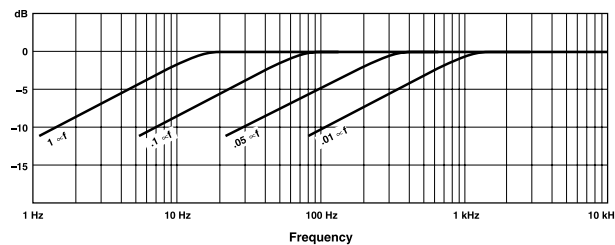

local radio stations, tape recorder bias and digital signal processors (DSP). To prevent high levels of input RF, install an appropriate low-pass filter in series with the input signal.

Some examples of unbalanced wiring for low-pass filters are shown in Figure 1.4.

For balanced input wiring use one of the examples in Figure 1.5. Filters A, B and C correspond to the unbalanced filters above. Filter D also incorporates the infrasonic filter described previously.

Figure 1.4
Unbalanced RFI Filters

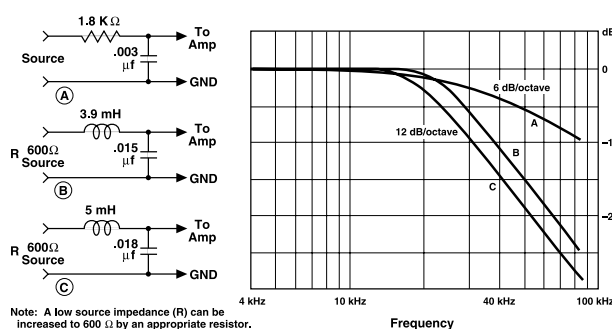

Note: A low source impedance (R) can be increased to 600 Ω by an appropriate resistor.

(ungrounded, 2-prong) or grounded (3-prong). Finally, if the source is unbalanced, check the type of wiring: twin-lead or single coax. Once you have determined the wiring scheme and cable type, refer to the applicable wiring diagram in Section 1.2.1.

Hum and Buzz

If you have noticeable hum or buzz in your system, you may want to check your cable connections to see if the unwanted noise is being introduced via a ground loop. To determine the proper wiring, first check whether the output from your source is unbalanced or balanced (if you don't know, refer to the unit's back panel or *Operation Manual*). Next, determine if the source's power cable is floating

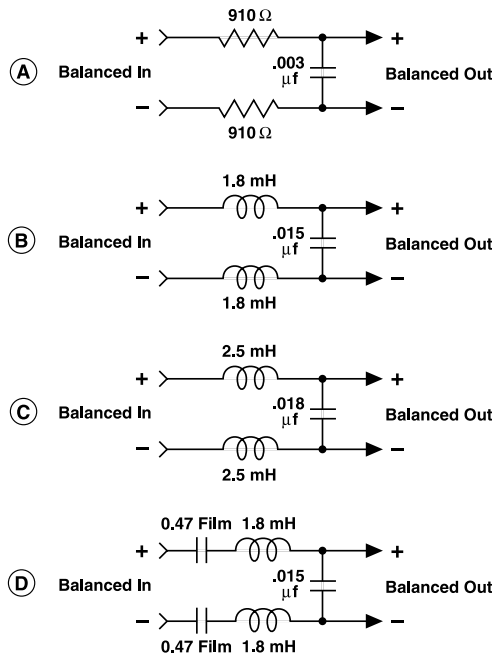

Figure 1.5
Balanced RFI Filters

Balanced vs. Unbalanced

A balanced audio circuit will have both positive (+) and negative (-) legs of the circuit that are isolated from the ground circuit. These balanced legs exhibit identical impedance characteristics with respect to ground, and may also carry the audio signal at the same level, but with opposite polarities. This results in a line that offers excellent rejection of unwanted noise.

On the other hand, an unbalanced circuit usually holds one leg at ground potential, while the second leg is “hot.” Unbalanced line is less expensive, but is much more susceptible to noise, and is not normally used in professional applications. For the cleanest signal, with less hum and buzz, a balanced line is always recommended. It is especially helpful if you have a long cable run (over 10 feet (3 m)), since noise is easily introduced into long, unbalanced lines.

1.3 Output Wiring

1.3.1 Output Connector Wiring

5-Way Binding Post

If the amplifier is set for Stereo (Dual), connect the positive (+) and negative (-) leads of each loudspeaker to the appropriate Channel 1 and Channel 2 output connectors as shown in Figure 1.6.

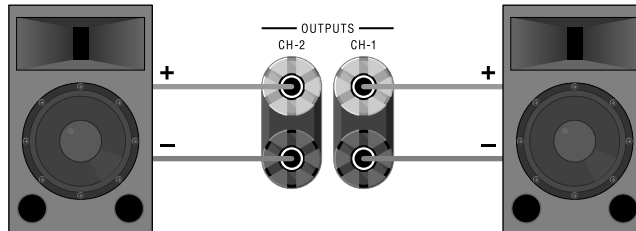

Figure 1.6
5-Way Binding Post Wiring for Stereo

If the amplifier is set for Bridge-Mono (if equipped), connect a mono load across the red binding posts of each channel as shown in Figure 1.7. Do NOT use the black binding posts when the amp is set for Bridge Output.

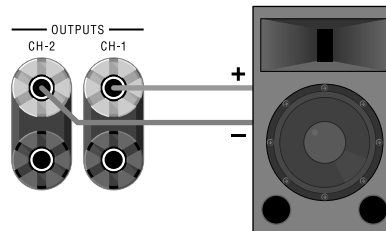

Figure 1.7
5-Way Binding Post Wiring for Bridge-Mono

Notice that the Channel 1 red binding post is positive (+) and the Channel 2 red binding post is negative (-).

If amp is set for Parallel-Mono (if equipped), connect a 14-gauge or larger jumper between the Channel 1 and Channel 2 Positive terminals, then connect a mono load to the Channel 1 binding posts as shown in Figure 1.8. Do NOT use the Channel 2 binding posts when the amp is set for Parallel Output. **Caution: Never short or parallel the output channels of an amplifier to itself or to any other amplifier.**

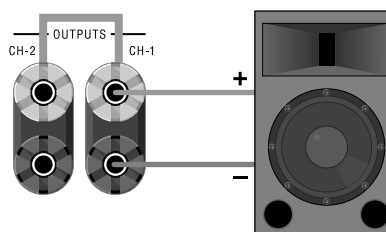

Figure 1.8
5-Way Binding Post Wiring for Parallel-Mono



Barrier Block

If the amplifier is set for Stereo (Dual), connect the positive (+) and negative (-) leads of each loudspeaker to the appropriate Channel 1 and Channel 2 output connectors as shown in Figure 1.9.

Figure 1.9
Barrier Block Wiring for Stereo

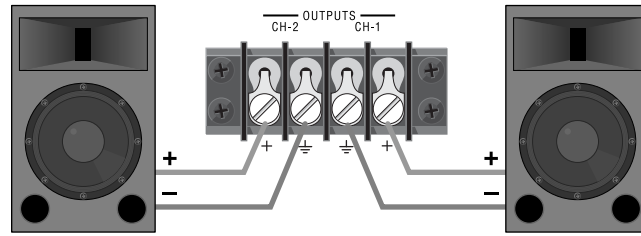

If the amplifier is set for Bridge-Mono (if equipped), connect a mono load across the positive terminals of each channel as shown in Figure 1.10. Do NOT use the negative terminals when the amp is set for Bridge Output.

Figure 1.10
Barrier Block Wiring for Bridge-Mono

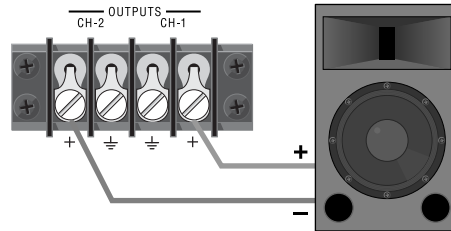

If the amplifier is set for Parallel-Mono (if equipped), connect 14-gauge or larger jumper between the Channel 1 and Channel 2 Positive terminals, then connect a mono load to the Channel 1 positive and negative terminals as shown in Figure 1.11. Do NOT use the Channel 2 terminals when the amp is set for Parallel Output. **Caution: Never short or parallel the output channels of an amplifier to itself or to any other amplifier.**

Figure 1.11
Barrier Block Wiring for Parallel-Mono

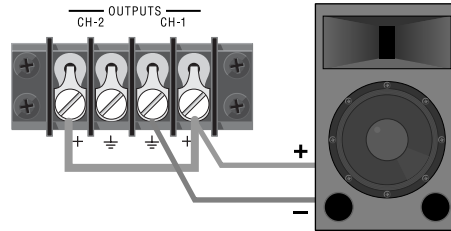

Output Wiring Tips

1. To prevent possible short circuits, wrap or otherwise insulate exposed loudspeaker cable or cable connectors.
2. Do not use connectors that might accidentally tie conductors together when making or breaking the connection (for example, a standard, 1/4-inch stereo phone plug).
3. Never use connectors that could be plugged into AC power sockets. Accidental AC input will be an electrifying experience for your equipment. But you will find out real quick if your speakers are any good at 60 Hz!
4. Avoid using connectors with low current-carrying capacity, such as XLRs.
5. Do not use connectors that have any tendency to short.

Neutrik® Speakon®

To assemble the Neutrik Speakon NL4FC connector, complete the following steps:

1. Slide the bushing (E) and chuck (D) onto the end of the cable as shown in Figure 1.12.
Note: Your NL4FC connector kit should contain both a black and a white chuck. Use the white chuck for cable with a diameter of 0.25 to 0.5 inch (6.35 to 12.7 mm). Use the black chuck for cable with a diameter of 0.375 to 0.625 inch (9.525 to 15.875 mm).
2. Strip approximately 3/4-inch (20-mm) of casing from the cable end. Strip approximately 3/8-inch (8-mm) from the end of each of the conductors down to bare wire (C).
- 3a. Insert each wire into the top of appropriate slot of the connector insert (B) as shown in Figure 1.13. Use a (1.5-mm) allen wrench or flat blade screwdriver to tighten the side connecting screws.

3b. If the Mode switch is in the “Stereo” position (for stereo configuration), connect the positive (+) and negative (–) leads of each wire to the appropriate Channel 1 and Channel 2 connectors as shown in Figure 1.14. You may use all 4 poles of the Channel 1 output connector to feed both speakers, if you wish.

3c. If the Mode switch is in the “Bridge” position (for mono configuration), connect the load across the positive (+) terminals of the connector as shown in Figure 1.15. For Bridge-Mono Mode, non-inverting output, Ch1+ is the positive (+) and Ch2+ is the negative (–).

3d. Never short or parallel the output channels of an amplifier to itself or any other amplifier.

4. Slide the connector insert (B) into the connector housing (A), making sure that the large notch on the outer edge of the insert lines up with the large groove on the inside of the connector housing. The insert should slide easily through the housing and out the other side until it extends approximately 3/4-inch (19-mm) from the end of the housing, as shown in Figure 1.16.

5. Slide the chuck (D) along the cable and insert into the housing, making sure that the large notch on the outer edge of the chuck lines up with the large groove on the inside of the connector housing. The chuck should slide easily into the insert/housing combination until only approximately 3/8-inch (9.5-mm) of the chuck end extends from the back end of the connector as shown in Figure 1.17.

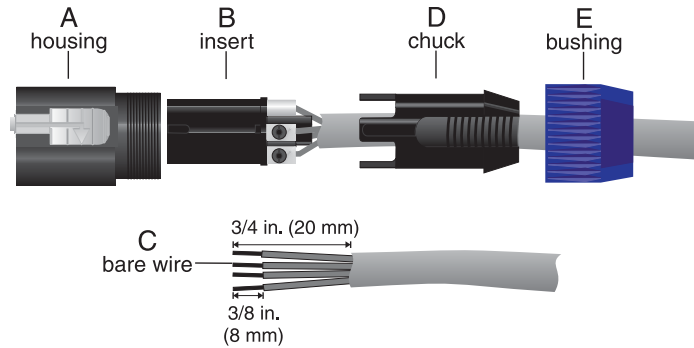

Figure 1.12

Order of Assembly for the Neutrik Speakon NL4FC Connector

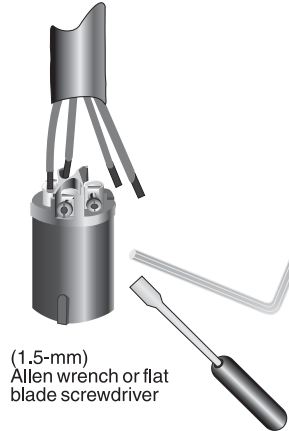

Figure 1.13

Wiring for the Neutrik Speakon NL4FC Connector

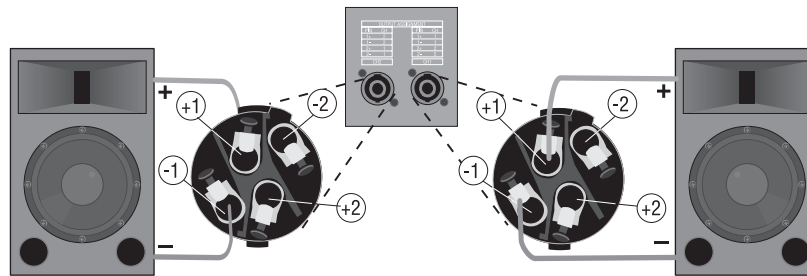

Figure 1.14

Stereo Output Wiring

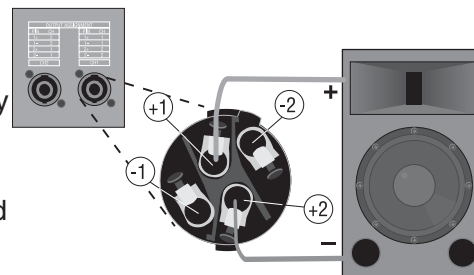

Figure 1.15

Bridge-Mono Output Wiring

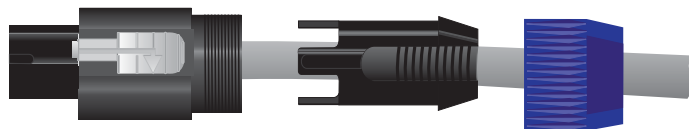

Figure 1.16

Connector Assembly: Insert into Connector Housing



Figure 1.17

Connector Assembly: Chuck into Connector Housing

Figure 1.18
Connector Assembly:
Bushing onto Connector
Housing Assembly

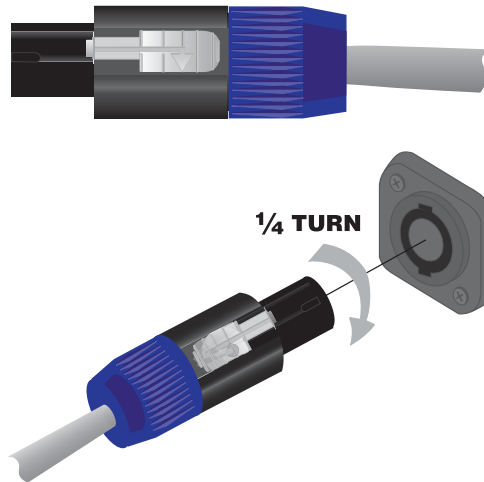

6. Slide the bushing along the cable and screw onto the end of the connector combination as shown in Figure 1.18. Note that the bushing features a special locking construction which will prevent disassembly of the NL4FC connector once this cap is tightened into place. Before tightening, you may want to test the connector in a live system to make sure it has been assembled properly.

Figure 1.19
Connecting the
Speakon plug to the
mating connector

To connect the Speakon plug into the mating connector on the speaker, line up the notches between the insert and the mating connector, then insert the plug and turn one quarter-turn clockwise as shown in Figure 1.19. The thumb-lock on the housing will snap into the locked position when the connector is properly seated.

1.3.2 Amplifier Load Impedance

A major consideration when matching amplifiers with speakers is the resulting impedance presented to the amplifier when speakers are connected to the output. The impedance of the load, in part, determines how much power the amplifier will produce. Also, too low of impedance can cause the amplifier to overheat.

Figure 1.20
Series Speaker
Impedances

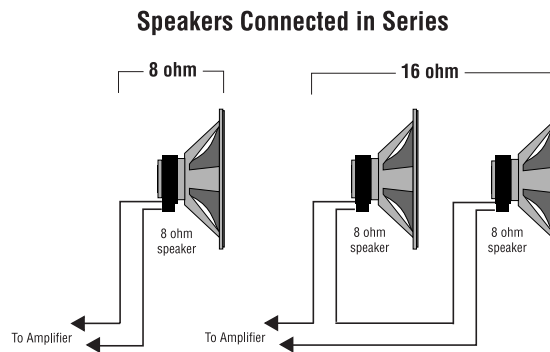

Impedance is much like resistance, except impedance changes with frequency. Impedance and resistance are both measured in ohms. To understand the effect of impedance in an electrical circuit, consider the following analogy: a wire is much like a water pipe. Electrical current is like the water flowing through the pipe. Impedance's role is that of the valve. The valve resists or impedes (hence the terms) the flow of water through the pipe. If the valve is opened (less impedance), water flows freely. As the valve is turned toward the closed position (more impedance), the flow of water slows. As the amplifier drives lower impedances, it produces more current, thus more power.

Figure 1.21
Parallel Speaker
Impedances

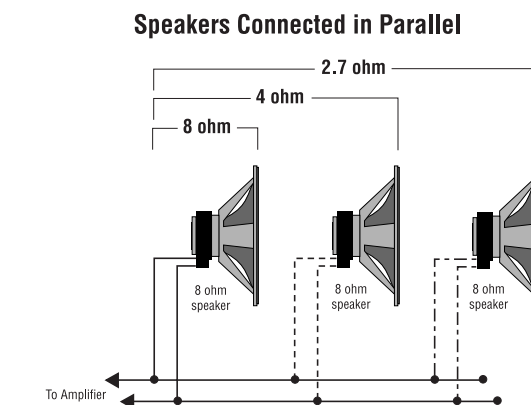

Each speaker has an impedance rating, typically 4 or 8 ohms. Connecting one 8-ohm speaker to an amplifier channel presents an 8-ohm impedance to the channel.

If two or more speakers are wired to the same channel, the net impedance presented to the channel will be either more or less than one of the speakers alone, depending on whether they were wired in series or in parallel (see Figures 1.20 and 1.21).

When speakers are wired in series, the net impedance presented to the amp is the sum of the individual impedances. When wired in parallel, the net impedance becomes less than the impedance of one of the speakers, as calculated with the following formula:

$$\frac{1}{R^T} = \frac{1}{R^1} + \frac{1}{R^2} + \dots + \frac{1}{R^n}$$

You can use the table in Figure 1.22 to find the net impedance for many common speaker combinations.

Note: for best results, do not wire speakers of differing impedances (one 4 ohm and one 8 ohm for example) together.

If two 8-ohm speakers are wired in series, they form one 16-ohm load for the amplifier, since impedances add when speakers are wired in series. If, on the other hand, the same 8-ohm speakers are wired in parallel, they form one 4-ohm load for the amplifier. The 4-ohm load will cause the amplifier to produce much more power than the 16-ohm load, and much more waste heat as well.

Parallel Impedances		
	4 Ohm Speakers	8 Ohm Speakers
1 Speaker	4 Ohm	8 Ohm
2 Speakers	2 Ohm	4 Ohm
3 Speakers	1.3 Ohm	2.7 Ohm
4 Speakers	1 Ohm	2 Ohm

Figure 1.22
Parallel Impedance Chart

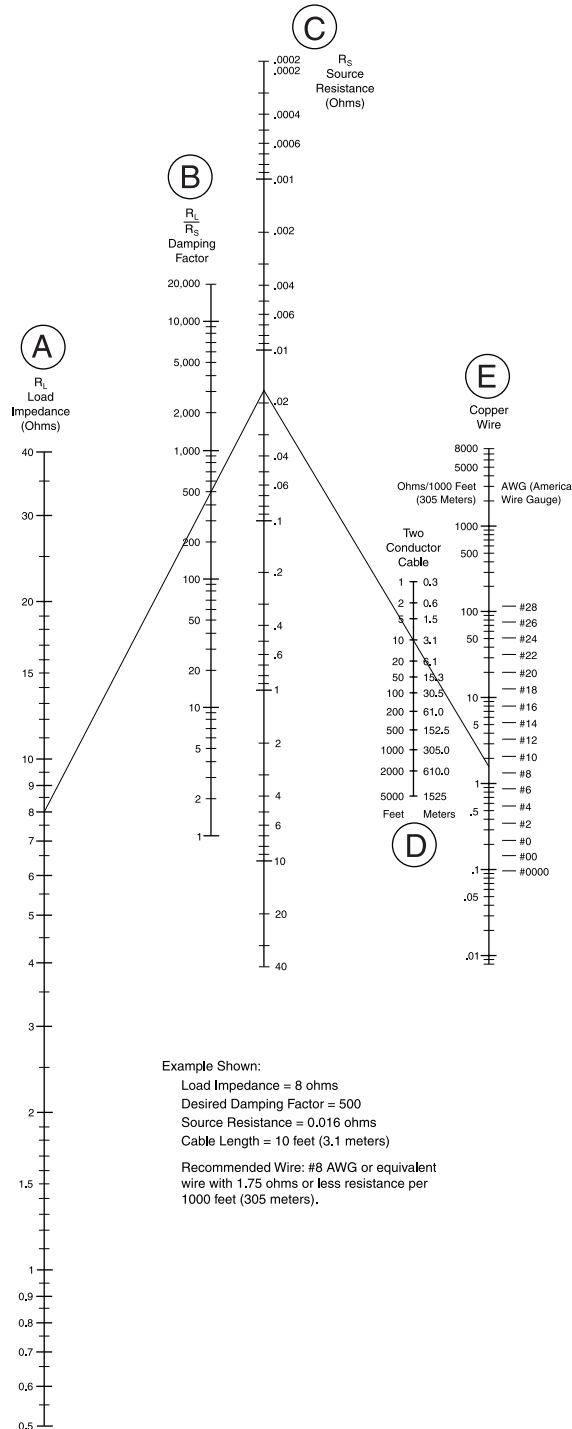

Figure 1.23
Wire Size Nomograph.

1.3.3 Determining Appropriate Speaker Wire Gauge

You should choose loudspeaker cables with sufficient gauge (thickness) for the length being used. The resistance introduced by inadequate loudspeaker cables will reduce both the output power and the motion control of the loudspeakers. The latter problem occurs because the damping factor decreases as the cable resistance increases. This is very important because the amplifier's excellent damping factor can easily be negated by insufficient loudspeaker cables.

Use the nomograph in Figure 1.23 and the procedure that follows to find the recommended wire gauge (AWG or American Wire Gauge) for your system.

1. Note the load impedance of the loudspeakers connected to each channel of the amplifier. Mark this value on the "Load Impedance" (A) line of the nomograph.
2. Select an acceptable damping factor and mark it on the "Damping Factor" (B) line. Higher damping factors yield greater motion control over the loudspeakers, and therefore lower distortion. A common damping factor for commercial applications is between 50 and 100. Higher damping factors may be desirable for live sound, but long cable lengths often limit the highest damping factor that can be achieved practically. In recording studios and home hi-fi, a damping factor of 500 or more is very desirable.
3. Draw a line through the two points with a pencil, and continue until it intersects the "Source Resistance" (C) line.
4. On the "2-Cond. Cable" (D) line, mark the required length of the cable run.
5. Draw a pencil line from the mark on the "Source Resistance" line through the mark on the "2-Cond. Cable" line, and on to intersect the "Copper Wire" (E) line.
6. The required wire gauge for the selected wire length and damping factor is the value on the "Copper Wire" line. Note: Wire size increases as the AWG gets smaller.
7. If the size of the cable exceeds what you want to use, (1) find a way to use shorter cables, (2) settle for a lower damping factor, or (3) use more than one cable for each line. Options 1 and 2 will require the substitution of new values for cable length or damping factor in the nomograph. For option 3, estimate the effective wire gauge by subtracting 3 from the apparent wire gauge every time the number of conductors of equal gauge is doubled. So, if #10 wire is too large, two #13 wires can be substituted, or four #16 wires can be used for the same effect.

PIPs for Speaker Protection

Depending on the application, you may want to use a *PIP*[™] module to protect your loudspeakers (for PIP-compatible amps only). When properly configured, all PIP modules with signal-driven compression can provide loudspeaker protection. For more information on available PIP modules with signal-driven compression, contact your Crown dealer or check the current selection of PIP modules at www.crown.com.

1.3.4 Loudspeaker Protection

Crown amplifiers generate enormous power. If your loudspeakers don't have built-in protection from excessive power, it's a good idea to protect them. Loudspeakers are subject to thermal damage from sustained overpowering and mechanical damage from large transient voltages. Special fuses can be used to protect your loudspeakers in both cases.

Two different types of fuses are required for thermal protection and voltage protection. Slow-blow fuses are usually selected to protect loudspeakers from thermal damage because they are similar to loudspeakers in the way they respond to thermal conditions over time. In contrast, high-speed instrument fuses like the Littlefuse 361000 series are used to protect loudspeakers from large transient voltages. The nomograph in Figure 1.24 can be used to select the properly rated fuse for either type of loudspeaker protection.

There are basically two approaches that can be taken when installing fuses for loudspeaker protection. A common approach is to put a single fuse in series with the output of each channel. This makes installation convenient because there is only one fuse protecting the loads on each output. The main disadvantage of this approach becomes obvious if the fuse blows because none of the loads will receive any power.

A better approach is to fuse each driver independently. This allows you to apply the most appropriate protection for the type of driver being used. In general, low-frequency drivers (woofers) are most susceptible to thermal damage and high-frequency drivers (tweeters) are usually damaged by large transient voltages. This means that your loudspeakers will tend to have better protection when the woofers are protected by slow-blow fuses and high-frequency drivers are protected by high-speed instrument fuses.

1.3.5 Solving Output Problems

High-Frequency Oscillations

Sometimes high-frequency oscillations occur which can cause your amplifier to prematurely activate its protection circuitry and result in inefficient operation. The effects of this problem are similar to the effects of the RF problem described in Section 1.2.2. To prevent high-frequency oscillations:

1. Lace together the loudspeaker conductors for each channel; do not lace together the conductors from different channels. This minimizes the chance that cables will act like antennas and transmit or receive high frequencies that can cause oscillation.
2. Avoid using shielded loudspeaker cable.
3. Avoid long cable runs where the loudspeaker cables from different amplifiers share a common cable tray or cable jacket.

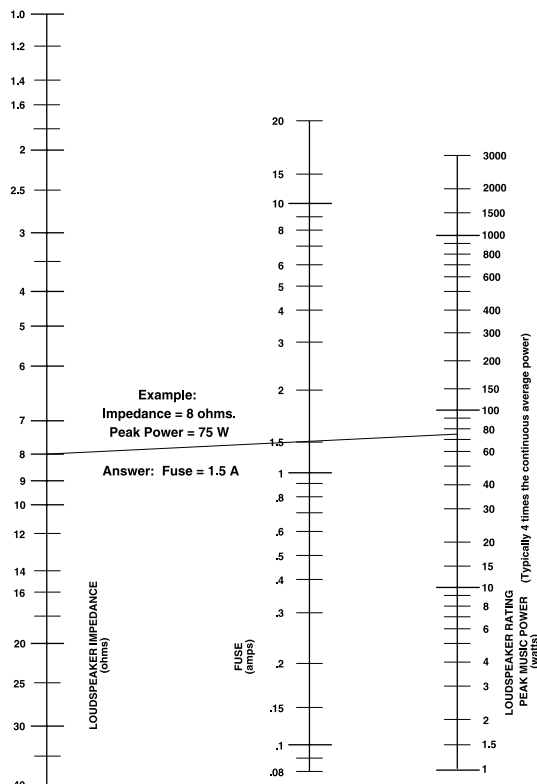
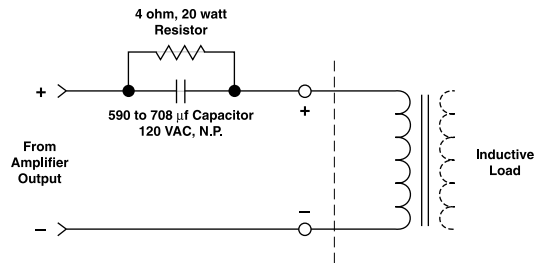

Figure 1.24
Loudspeaker Fuse
Nomograph

Figure 1.25
Inductive Load (Transformer) Network



input line (similar to the RF filters described in Section 1.2.2).

8. Install input wiring according to the instructions in your amplifier's *Operation Manual*.

4. Never connect the amplifier's input and output grounds together.
5. Never tie the outputs of multiple amplifiers together.
6. Keep loudspeaker cables well separated from input cables.
7. Install a low-pass filter on each

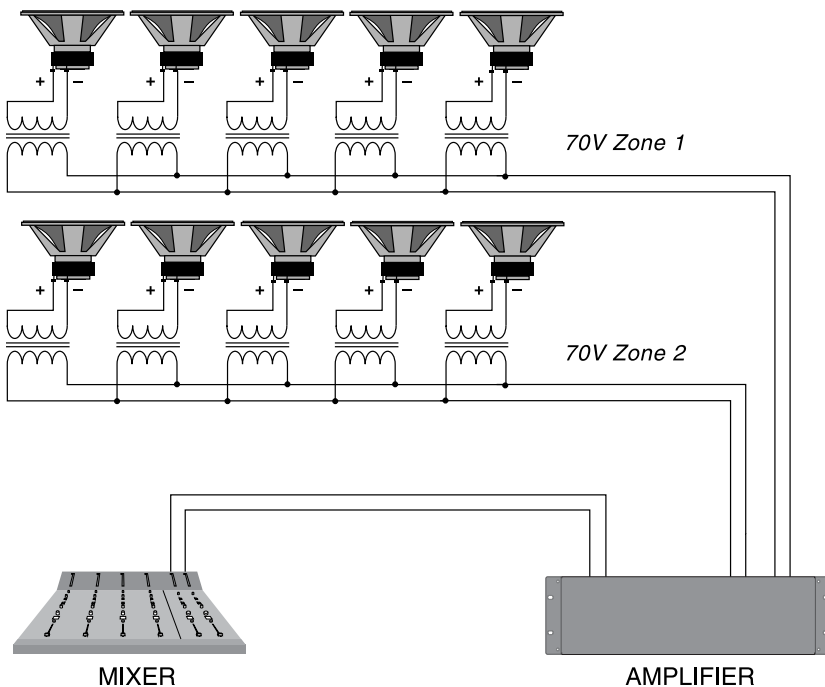

Figure 1.26
Typical Distributed Speaker System

from prematurely activating its protection systems and to protect inductive loads from large low-frequency currents is to connect a 590 to 708 μF non-polarized capacitor and 4-ohm, 20-watt resistor in series with the amplifier's output and the positive (+) lead of the transformer. The circuit shown in Figure 1.25 uses components that are available from most electronic supply stores.

1.3.6 Distributed Speaker Systems

Multiple-speaker systems for paging and background music systems are common in such facilities as schools, restaurants, industrial facilities offices and retail. In these systems, many speakers are distributed throughout the facility, often across long distances, making them difficult and expensive to implement with traditional, direct low-impedance amplifiers. A less expensive and more reliable method is the distributed speaker system.

A distributed speaker system consists of an amplifier or amplifier channel driving one or more speakers with transformers connected to a pair of wires called a "home run." The transformers step the line voltage down to a lower

Sub-Sonic Currents

Another problem to avoid is the presence of large sub-sonic currents when primarily inductive loads are used. Examples of inductive loads are 70-volt transformers and electrostatic loudspeakers.

Inductive loads can appear as a short circuit at low frequencies. This can cause the amplifier to produce large low-frequency currents and activate its protection circuitry. Always take the precaution of installing a high-pass filter in series with the amplifier's input when inductive loads are used. A 3-pole, 18-dB-per-octave filter with a -3 dB frequency of 50 Hz is recommended (depending on the application, an even higher -3 dB frequency may be desirable).

Another way to prevent the amplifier

level to drive the speaker, and are connected across the wires (see Figure 1.26). The combination of transformer and speaker line presents a much higher impedance to the amplifier than would the speaker itself, making it possible to add many speakers to a single home run.

In distributed speaker systems, as the ratio of voltage to current become greater, less power is lost on the home run. This makes it possible to use much smaller gauge wire for home runs than would otherwise be possible.

What is Constant Voltage?

“Constant-voltage” amplifiers do not, in fact, supply a constant output voltage. The audio is represented with varying voltage just as with a low-impedance amplifier. The term “constant-voltage” was arrived at for two reasons. First, constant-voltage amplifiers produce their maximum power when the output voltage reaches the specified value. For example, an amplifier rated at 200 watts, when set to 70V output, will produce 200 watts when the output voltage reaches 70V. Second, the output voltage of an amplifier driving a constant-voltage (distributed) speaker run remains constant across a wide range of impedances.

Transformer Saturation

It's important to know that transformers can easily become “saturated” at low-frequencies. Transformer saturation occurs when the magnetic field created by the signal content becomes too much for the core of the transformer to handle. This condition can be dangerous to the amplifier, and can also cause distortion.

An effective way to prevent step-down transformer saturation is to filter the very low-frequency content from the audio. Your amplifier may provide high-pass filters for this purpose (see your *Operation Manual*). If not, see Section 1.2.2 for filter suggestions.

1.4 Multi-way Systems (with Expansion Modules)

This section shows how multi-way systems can be effectively designed using optional expansion modules that feature active crossover networks. Example systems are shown for single and multiple amp two-way systems and three-way systems.

The range of frequencies present in full-range music is wider than most any single speaker component can accurately reproduce. Because of this, most professional speaker systems employ two or more speaker components to do the job. Crossover networks (or crossovers) are electrical circuits that divide an incoming signal into two or more separate frequency bands. The separate bands are then routed to speakers designed to reproduce the range of frequencies they are being fed.

1.4.1 Active vs. Passive Crossover Networks

There are two types of crossovers: active and passive. Passive crossover networks are located in the signal chain between the amplifier and speakers. The networks built into speaker cabinets are typically passive. The primary advantage to passive crossovers is that they use fewer amplified channels. The primary disadvantage is that they work with amplified or high-voltage signals because of being located after the amplifier in the signal chain, causing them to waste much of the power before it gets to the speakers. They also have lower dynamic range.

Active crossovers are typically located before the amplifier in the signal chain. They work with lower “line-level” signals, meaning they waste much less power.

Using Low-Impedance

You can use amps without constant-voltage settings on distributed speaker systems if the power output is high enough. For example, an amplifier rated for 78 watts output into 8 ohms will directly drive a 25-volt line. To calculate the necessary power for driving a specific voltage line use the following formula:

$$P = \frac{V^2}{R}$$

where P equals the necessary power output, V equals the voltage of the distributed speaker system, and R equals the impedance of the amplifier for the power specifi-

Figure 1.27
Typical Single-Amp, Stereo, Two-Way Hookup

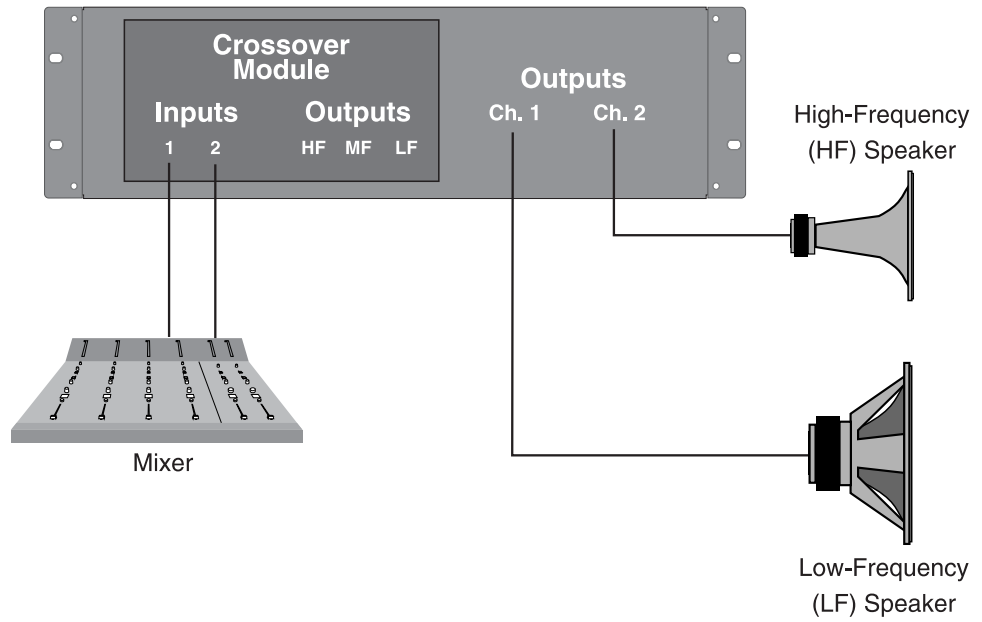
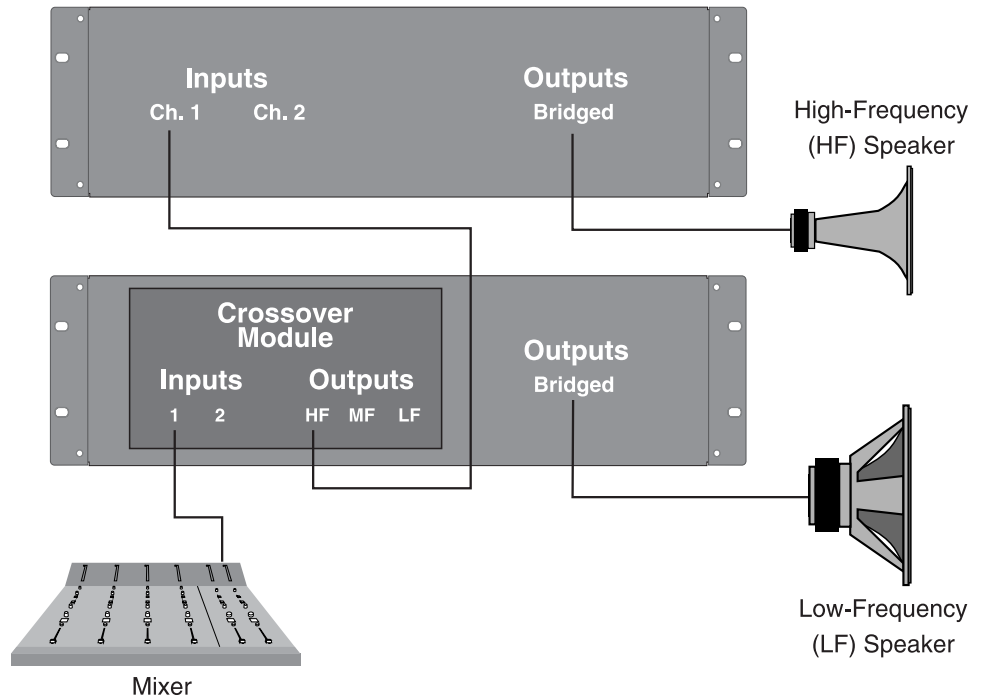

Figure 1.28
Typical Two-Amp, Bridge-Mono, Two-Way Hookup



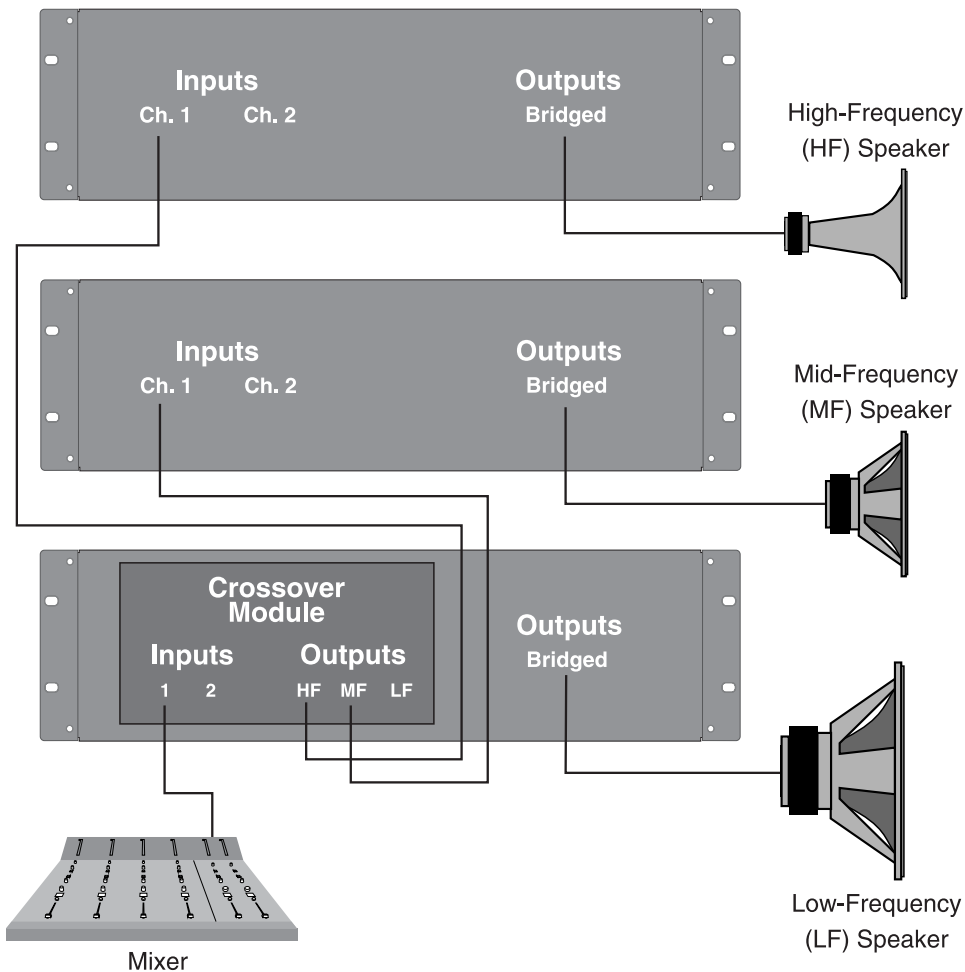

Figure 1.29
Typical Three-Amp,
Bridge-Mono,
Three-Way Hookup

When you use an active crossover to split the power drive to the loudspeaker components, you gain a wide range of advantages, including:

1. Increased gain because the insertion loss of passive crossover networks is eliminated.
2. Consistent power bandwidth: power bandwidth is changed in multi-way passive systems if transducers change impedance or vaporize (blow up).
3. Levels can be matched more accurately to the components.
4. Improved dynamic range.

Active crossovers for Crown amps are available in both PIP and SST modules (see your *Operation Manual* for details about available options for your amplifier).

Figures 1.27 through 1.29 illustrate typical systems using active crossover modules.

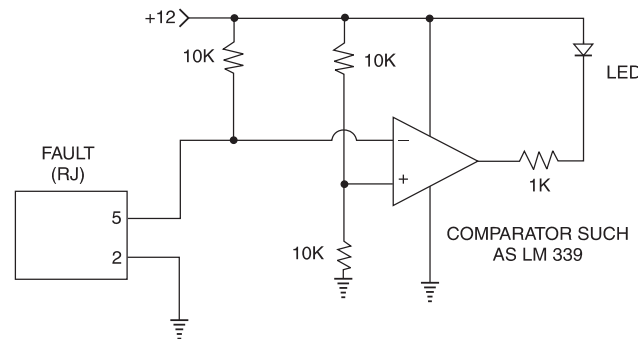
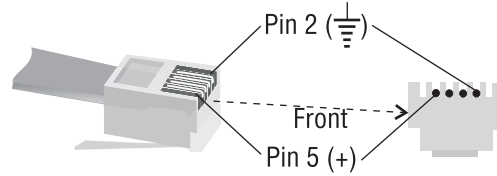

Figure 1.30
Fault Status External
Circuit Design

Figure 1.31
RJ Jack Wiring and
Pin Assignments



1.5 Fault Monitoring

The Fault (RJ-11) jack, which looks like a telephone plug, is located on the back of your amplifier (if equipped). It gives you an easy way

to remotely monitor the amplifier's fault status. To set up a circuit that will cause an LED to light whenever a fault status occurs, you can simply use the suggested circuit shown in Figure 1.30.

When using this circuit, the LED will glow whenever the amplifier is in one of four states: a channel's heatsink has reached its temperature limit, the transformer has reached its temperature limit, the amplifier has just been turned on and is in its turn-on-delay mode, or the amplifier is turned off.

If you choose to design your own circuit to interface this signal to your system, note that this RJ jack is polarity sensitive. Pin 2 must be grounded, and Pin 5 must be supplied with a positive voltage pull up (positive with respect to ground). Refer to Figure 1.31 for RJ jack pin assignments. Note: the mating connector for the RJ-11 jack contains 4 contact pins in a six-slot case, as shown in Figure 1.31. The maximum signal that can be exposed to the fault jack is 35 VDC and 10 mA. Best results are obtained with 10 mA LEDs.

Figure 1.32
Optimal System
Headrom.

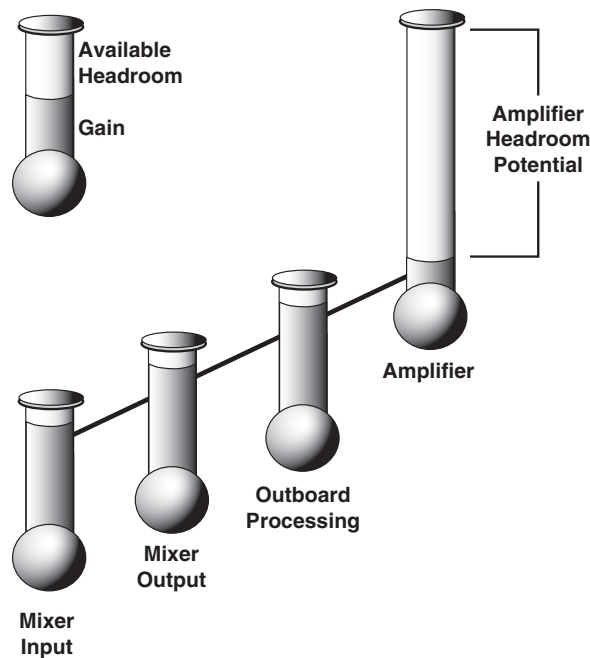

1.6 Setting System Gain Structure

To get the best performance from your sound system, you should carefully set up your system's gain structure. Gain structure is a term that refers to the way the various levels are set at each stage of your sound system. Good gain structure lets you get your intended signal out with the most available headroom, and the least amount of noise.

This section provides a basic procedure to use to set up your

system's gain structure, designed to get you up and running as quickly as possible. We could go into much more detail on this subject, but that would be beyond the scope of this manual. If you have questions about system gain structure, refer to the Appendix for a list of recommended publications for further reading.

1.6.1 System Levels

When setting system gain, start at the front of the system and work your way toward the amplifier. A system with the lowest noise floor and maximum overall gain will have most of its gain early in the signal chain.

Start out by setting your mixer's individual channels to 0 dB. The individual channels will vary somewhat from this in the course of setting the mix, but it is a good target position. Also, if your mixer has a +4/-10 dB switch on the output, set it to the +4 dB position.

Next, if your mixer has input trim controls for the mic channels, set them for the highest possible gain (but short of clipping) by having someone speak or sing into the mic while monitoring the mixer's metering.

Set up your mix for the balance of signals as you want them, keeping the input faders somewhere around the 0 dB point. If necessary, turn down the trim on a channel if you're not able to keep the fader near the 0 dB point.

After the mix is set, adjust the master levels on the mixer to 0 dB. Any signal processing equipment should generally be set to 0 dB as well, with some exceptions (refer to each component's documentation for details).

1.6.2 Amplifier Level

Before you can know how to set your amps level controls, you need to understand how they work. Amplifier level controls are typically not "gain" controls. They do not control the amount of gain the amplifier produces. You may be tempted to immediately turn your amps level control all the way up (after all, you do want all the Crown power you can get, don't you?). While that approach could work sometimes, usually it will yield more noise and less overall system gain than would otherwise be possible.

Power amplifiers are designed to produce a set amount of gain. The function of the level control knob typically is to adjust the signal level coming into the amplifier's input stage. Where to set the level controls on the amp depends on the system and how much gain you have available prior to the amplifier. With the level controls turned down the amplifier can still reach full rated output power, it just takes more drive level from your mixer to achieve it.

First, check to make sure your mixer or console is being operated at optimum signal-to-noise, without clipping the output. Then—with your amplifier's input sensitivity set to the 26 dB position (if equipped)—turn up your amp's level controls until you achieve the desired level (loudness). If you turn the level controls all the way up, and it's still not loud enough, turn the amplifier level controls all the way down (counter-clockwise). Then, change the sensitivity switch to the 1.4V position (if equipped). This will increase the gain of the amplifier. Now carefully turn the amplifier level controls up (clockwise) to the desired level (loudness). If it's still not loud enough, and your amplifier has a 0.775V sensitivity setting, turn the amplifier level controls all the way down (counter-clockwise), then change the sensitivity switch to the 0.775V position. Take care when you are adjusting the level controls at this input sensitivity setting. Increasing the input sensitivity of the amplifier may cause the input stage of the amp to overload, so be prepared to back down the output of the mixer by 1 or 2 dB if you notice the amplifier's warning indicators beginning to flash.

Note: depending upon your model of Crown amplifier, sensitivity settings are internal and NOT user-selectable. Internal sensitivity settings may only be adjusted by qualified service personnel. Refer to your amplifier's *Operation Manual* for specifics about sensitivity settings on your amplifier.

Chapter 2

Troubleshooting

In This Chapter

- Troubleshooting Flowcharts

This section provides flowcharts to assist you in troubleshooting problems with your amplifier. In some situations the problem may not be with the amplifier, but rather may be caused by a system condition.

The flowcharts do not cover every possible scenario you may encounter.

Figure 2.1 provides a key to help you interpret the flowcharts.

Figure 2.1
Flowchart Key

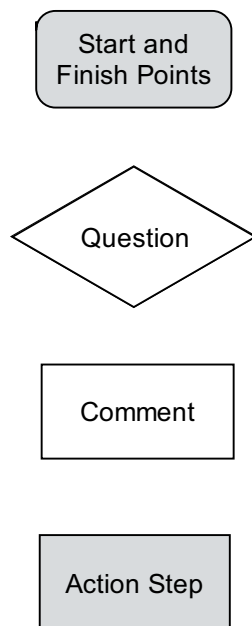

2.1 No Power

Figure 2.2
No Power

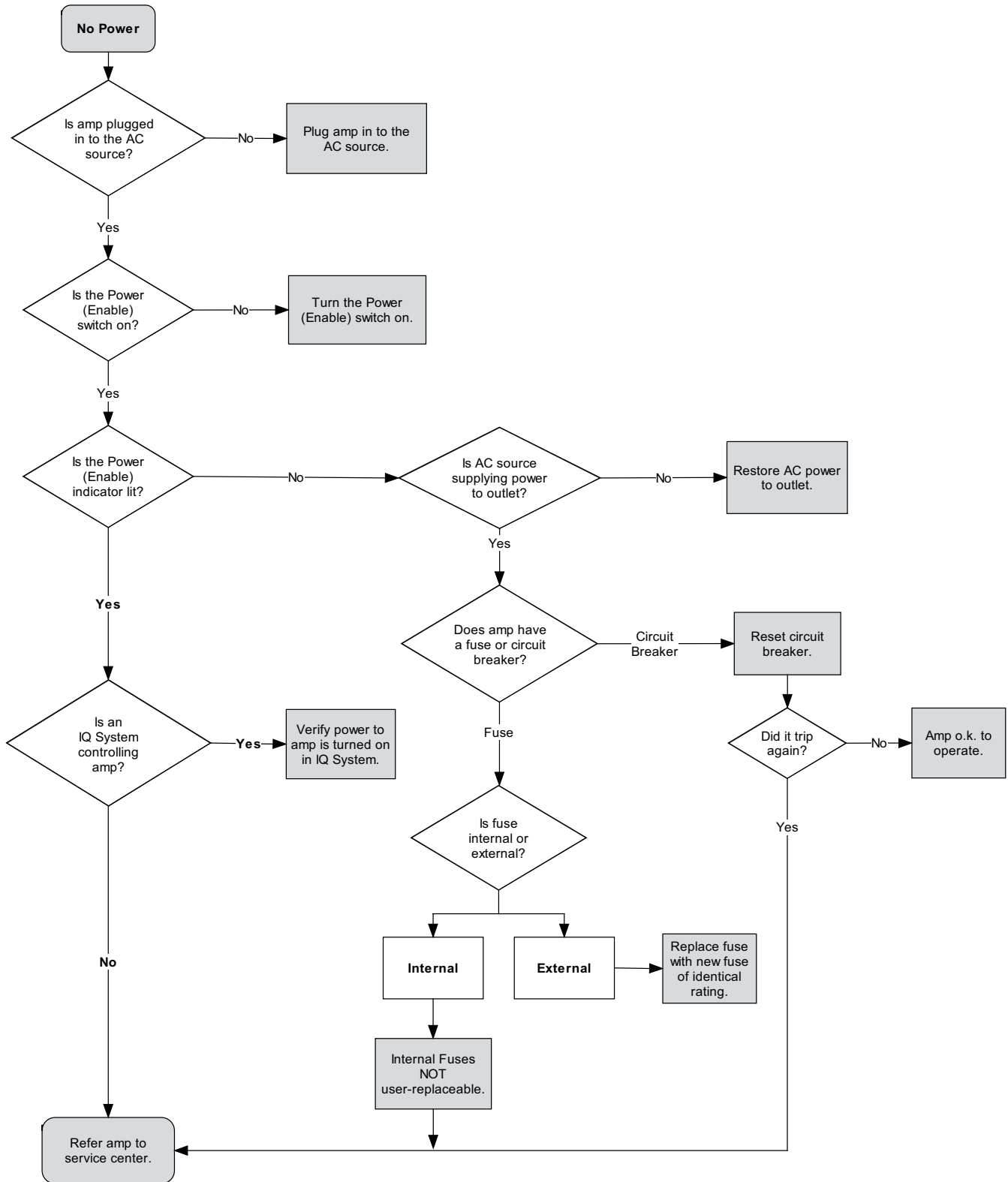
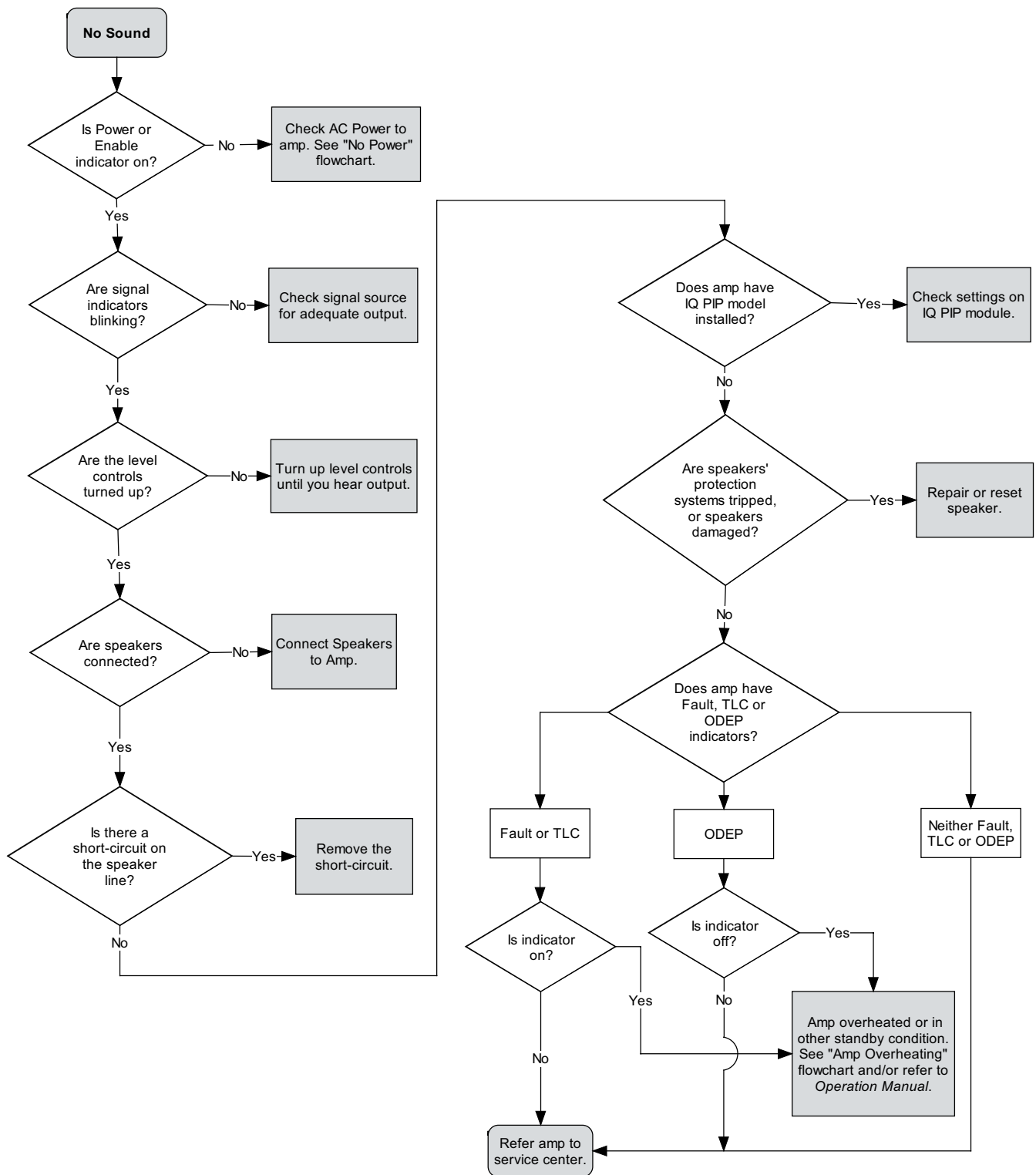

Figure 2.3
No Sound

2.2 No Sound



2.3 Bad Sound

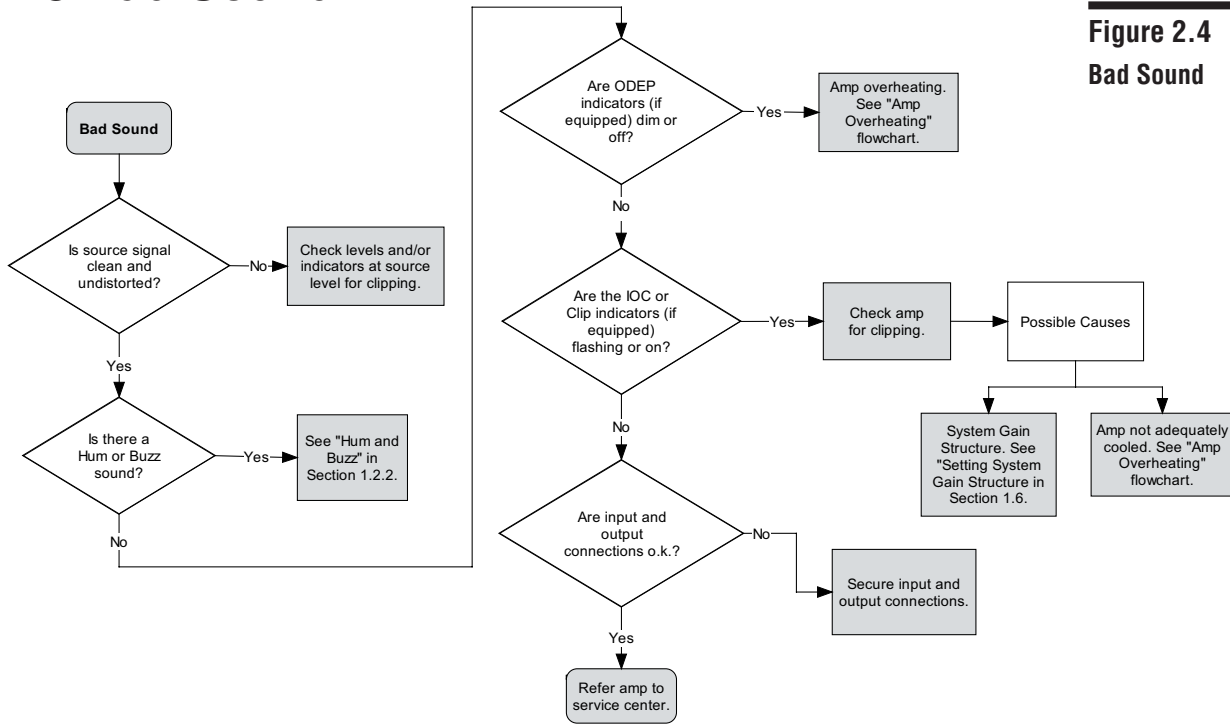

Figure 2.4
Bad Sound

2.4 Amp Overheating

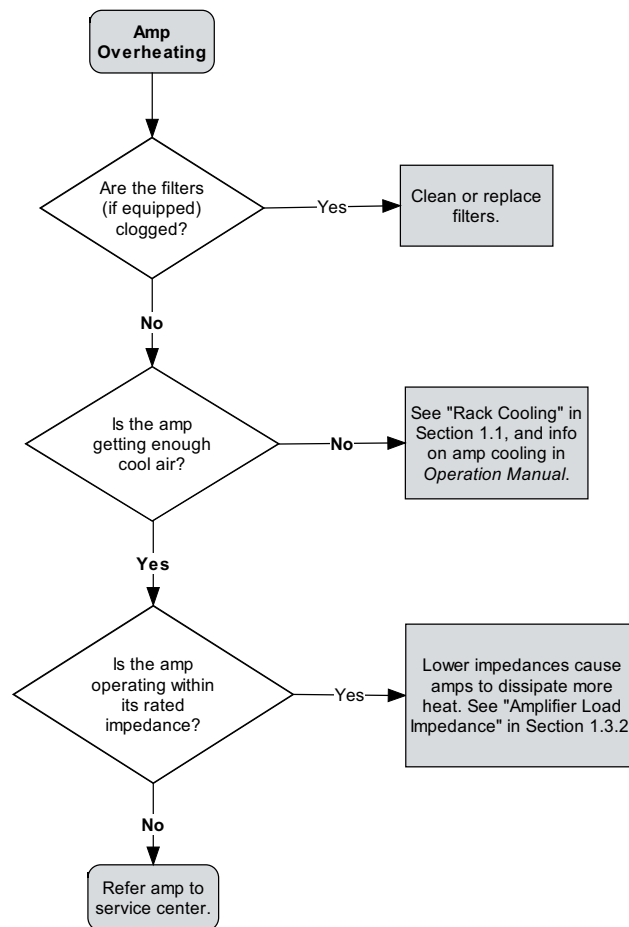

Figure 2.5
Amp Overheating

Chapter 3

Glossary of Terms

In This Chapter

- Glossary of Terms

This section provides a handy glossary of terms used in the discussion of professional audio amplifiers. Some terms are unique to Crown amplifiers. Most of the terms provided do not directly relate to amplifiers, but as amplifiers are but one piece of a larger audio system, are often used when discussing amp usage.

Amperage

A measure of electrical current flow, also called “amps” for short. It literally equates to the number of electrons in a conductor flowing past a certain point in a given amount of time. Ohms law defines current (I) as voltage (V) divided by resistance (R) with the following expression: $I=V/R$.

Amplifier (Amp)

A device that increases signal. Many types of amplifiers are used in audio systems. Amplifiers typically increase voltage, current, or both.

Amplifier Class

Audio power amplifiers are classified primarily by the design of the output stage. Classification is based on the amount of time the output devices are made to operate during each cycle of swing. Amplifiers are also defined in terms of output bias current (the amount of current flowing in the output devices with no signal present). Common amplifier classes used in professional audio amplifiers include AB, AB+B, D, G and H.

Attenuation

A decrease in the level of a signal is referred to as attenuation. In some cases this is unintentional, as in the attenuation caused by using wire for signal transmission. Attenuators (circuits which attenuate a signal) may also be used to lower the level of a signal in an audio system to prevent overload and distortion.

Balanced Line

A cable with two conductors surrounded by a shield, in which each conductor is at equal impedance to ground. With respect to ground, the conductors are at equal potential but opposite polarity; the signal flows through both conductors.

Band-Pass Filter

In a crossover, a filter that passes a band or range of frequencies but sharply attenuates or rejects frequencies outside the band.

Barrier Block/Barrier Strip

A series of connections, usually screw terminals, arranged in a line to permanently connect multiple audio lines to such devices as recording equipment, mixers, or outboard gear. Also called terminal strip.

BCA®

BCA (Balanced Current Amplifier) is Crown’s patented PWM (Pulse-Width Modulation) amplifier output stage topology. Also referred to as “class-I,” Crown’s BCA “switching” technology provides for high output, exceptional reliability and nearly twice the efficiency of typical amplifier designs. To learn more about BCA, download and read the BCA white paper at www.crownaudio.com.

Binding Post (5-Way, Banana)

A type of electrical terminal, a binding post is most commonly found as the output connector on a power amplifier, or as the connectors on a speaker cabinet. A binding post can accept banana plugs, spade lugs, bare wire and others. Generally, binding posts are color coded, with the black connection going to ground, and the red connecting to hot.

Bridge-Mono

An operating mode of an amplifier that allows a single input to feed two combined output channels in order to provide a single output with twice the voltage of an individual channel in Stereo or Dual mode.

Bus

In audio terms, a Bus is a point in a circuit where many signals are brought together. For example: Most electronic items have a Ground Bus where all of a device's individual ground paths are tied together. In mixers, we have Mix Busses, where multiple channels' signals are brought (or blended) together, and Aux Busses, where feeds from channels are brought together to be routed to an external processor or monitor send, etc. In general, the more busses a mixer has, the more flexible the routing capabilities of that mixer will be.

Capacitor

An electronic component that stores an electric charge. It is formed of two conductive plates separated by an insulator called a dielectric. A capacitor passes AC but blocks DC.

Channel Separation

Relates to crosstalk, or bleed of audio signals from one channel to another. The amount of channel separation is inversely related to the item's crosstalk spec; i.e. a low crosstalk spec indicates high channel separation.

Circuit Breaker

A resettable device intended to provide protection to electrical circuits. It opens when current flows through it that exceeds its current rating.

Clipping

A specific type of distortion. If a signal is passed through an electronic device which cannot accommodate its maximum voltage or current requirements, the waveform of the signal is sometimes said to be clipped, because it looks on a scope like its peaks have been clipped off by a pair of scissors. A clipped waveform contains a great deal of harmonic distortion and often sounds very rough and harsh. Clipping is what typically happens when an audio amplifier output is overloaded or its input over driven.

A Clip Indicator on an amplifier indicates the presence of clipping distortion.

Compressor

A compressor is a device that reduces the dynamic range of an audio signal. First a threshold is established. When the audio signal is louder than this threshold, its gain is reduced.

Crossover Network (Crossover)

An electronic network that divides an incoming signal into two or more frequency bands.

Crossover Slope

High- and low-pass filters used for speakers do not cut off frequencies like brick walls. The roll-off occurs over a number of octaves. Common filter slopes for speakers are 1st- through 4th-order corresponding to 6 dB per octave to 24 dB per octave. For example, a 1st-order, 6 dB per octave high-pass filter at 100 Hz will pass 6 dB less energy at 50 Hz, and 12 dB less energy at 25 Hz. Within the common 1st through 4th filters there is an endless variety of crossover types including Butterworth, Linkwitz-Riley, Bessel, Chebychev and others.

Crosstalk

Signal bleeding or leaking from one channel of a multi-channel device to another.

Current

Literally, the rate of electron flow in an electrical circuit. Cur-

rent is measured in Amperes (or Amps), abbreviated I. Ohm's law defines current as voltage (V) divided by resistance (R) with the following expression: $I=V/R$.

Damping Factor

Though technically more complex than this, damping factor is usually thought of as an indicator of how tight an amplifier will sound when powering bass speakers. A speaker's driving motor is a coil of wire (called a voice coil) mounted within a magnetic field. As this coil of wire moves within the field a voltage will be induced in the voice coil. If resonant motions of the speaker are not sufficiently short-circuited by the amplifier, the speaker output can have an over accentuated or "boomy" bass sound.

From a technical measurement stand point, damping factor is the ratio of the rated speaker impedance to the amplifier's output impedance. Low output impedance is the consequence of the amplifier having substantial negative voltage feedback taken from its output terminals. Properly designed negative feedback not only corrects for output voltage errors induced by the speaker but also produces other benefits, including low distortion, low noise (hiss), and flat frequency response.

DC Output Offset

The presence of DC (Direct Current) at the output of the amplifier. Any more than approximately 10 millivolts (positive or negative) could be an indication of a problem within the amplifier.

Decibel

A decibel, a tenth of a bel, is used as an expression of the ratio between signal levels.

One decibel is commonly taken as the smallest volume change the human ear can reasonably detect. Doubling the POWER of an amplifier results in a 3 dB increase, which is a "noticeable" volume increase. Doubling the VOLUME of a sound is a 10 dB increase.

dBV is decibels relative to 1 volt. dBu is decibels relative to 0.775 volt. dBm is decibels relative to 1 milliwatt.

Distributed Speaker System (Constant Voltage System)

A type of speaker system where transformers typically are used at the output of an amplifier and at each speaker in order to provide a constant voltage (most commonly 70V or 100V) that can be tapped by multiple speakers. These lines can be run great distances with less loss and can have many more speakers on them than typical high current speaker lines. These types of systems are generally employed in situations where an amplified signal must be distributed over vast areas without a need for very high sound level in any one area. This type of P.A. system is typically used in schools, churches, business offices, and other commercial facilities.

Dynamic Range

The dynamic range of a sound is the ratio of the strongest or loudest part, to the weakest or softest part; it is measured in dB. An orchestra may have a dynamic range of 90 dB, meaning the softest passages have 90 dB less energy than the loudest ones.

EMI

EMI (Electro Magnetic Interference) refers to interference in audio equipment produced by the equipment or cabling picking up stray electromagnetic fields. This interference usually

manifests itself as some type of hum, static, or buzz. Such electromagnetic fields are produced by fluorescent lights, power lines, computers, automobile ignition systems, television monitors, solid state lighting dimmers, AM and FM radio transmitters, and TV transmitters. Methods for controlling EMI include shielding of audio wiring and devices, grounding, elimination of ground loops, balancing of audio circuits, twisting of wires in balanced transmission lines, and isolation transformers among others. Completely eliminating EMI in a system ranges from easy to nearly impossible depending upon the equipment and the environment in question.

Equalization (EQ)

The adjustment of frequency response to alter tonal balance or to attenuate unwanted frequencies.

Fader

Another name for variable attenuator, volume control, or potentiometer. A fader works like a standard potentiometer, only instead of rotating, it slides along a straight path. Faders are commonly found on mixers.

Fault

A term used to describe any condition that could cause an amplifier or amplifier channel to place itself in "standby" or offline mode for protection.

An indicator on some Crown amplifiers that blinks to show that the amplifier is in "Fault," or a standby or offline condition.

Frequency

In audio, the number of cycles per second of a sound wave of an audio signal, measured in hertz (Hz). A low frequency (for example 100 Hz) has a low pitch; a high frequency (for example 10,000 Hz) has a high pitch.

Frequency Range/Frequency Response

Frequency Range is the actual span of frequencies that a device can reproduce, for example from 5 Hz to 22 kHz.

Frequency Response is the Frequency Range versus Amplitude. In other words, at 20 Hz, a certain input signal level may produce 100 dB of output. At 1 kHz, that same input level may produce 102 dB of output. At 10 kHz, 95 dB, and so on.

Fuse

A device intended to provide protection to electrical circuits. It burns open when current flows through it that exceeds its current rating.

Gain

How much an electronic circuit amplifies a signal is called its "gain." In most specs or references gain is expressed as a decibel value. Occasionally gain may be expressed as a straight numeric ratio (a voltage gain of 4 or a power gain of 2).

Ground

In electricity, a large conducting body, such as the earth or an electric circuit connected to the earth, used as a reference zero of electrical potential.

A conducting object, such as a wire, that is connected to a position of zero potential for the purpose of "grounding" an electronic device.

A power ground or safety ground is a connection to the power company's earth ground through the power outlet. In the power ground of an electronic component with a grounded

plug, the ground connection on the plug is wired to the component's chassis. This wire conducts electricity to power ground if the chassis becomes electrically "hot," preventing electrical shock.

In audio, ground usually refers to either the electrical ground mentioned above, or to an audio shield. An audio shield is not always a ground and should never be used as a safety ground. That they are often at ground potential is a function of how they may be connected to other equipment. Many audio devices have the ability to disconnect their signal paths entirely from electrical ground as a way to prevent hum or ground loop problems.

Verb - to "ground" something means connecting it electrically to ground.

Ground Lift

Ground lift is a switch found on many pieces of audio equipment which disconnects audio signal ground from earth or chassis ground.

Using ground lift switches is considered to be far safer than the "3-to-2 prong AC adapter" solution.

Ground Loop

A loop or circuit formed from ground leads.

The loop formed when unbalanced components are connected together via two or more ground paths—typically the connecting-cable shield and the power ground. Ground loops cause hum and should be avoided.

Grounded Bridge™

Grounded Bridge is the name of an amplifier output topology developed by Crown in the 1980's, and used in many Crown amplifier models. The patented Grounded Bridge design consists of four quadrants and an ungrounded power supply. While two of the output quadrants operate much like a conventional (AB+B push-pull) linear amplifier, the other two work in a push-pull configuration to control ground reference for the supply rails.

To learn more about Grounded Bridge, download and read the Grounded Bridge white paper at www.crownaudio.com.

Headroom

The difference between the normal operating level of a device, and the maximum level that device can pass without distortion. In general the more headroom the better.

Hertz

The inverse of the time required for one complete cycle of a wave. Thus, a 10 Hz sine wave takes 1/10 of a second to complete a full cycle. In practice, it is the frequency or number of wave cycles occurring per second. In the audio range this equates to what we perceive as pitch. Abbreviated Hz.

High-Pass Filter

A filter that passes frequencies above a certain frequency and attenuates frequencies below that same frequency. It can also be called a low-cut filter.

Hum

An unwanted low-pitched tone (60 Hz and its harmonics) heard in the speakers. The sound of interference generated in audio circuits and cables by AC power wiring. Hum pickup is caused by such things as faulty grounding, poor shielding, and ground loops.

Load/Limit Indicator

An indicator of some Crown amplifiers that shows current flow to the loudspeakers (“current load”) and the maximum current available from the amplifier (“current limit”). Typically, the indicator will glow one color to indicate that current is flowing to the loads connected to the amplifier output channel, and change to another color to show that the amplifier channel is delivering its maximum output current.

Impedance

Impedance refers to the resistance of a circuit or device to AC (alternating current). Most modern electronic audio devices have extremely high input impedances so they can be driven by very low power outputs. Impedance is measured in ohms. The symbol Ω (omega) is often used to represent resistance.

Input

The connection going into an audio device. In a mixer or mixing-console, a connector for a microphone, line-level device, or other signal source.

Intermodulation Distortion (IMD)

Nonlinear distortion that occurs when different frequencies pass through an amplifier at the same time and interact to create combinations of tones unrelated to the original sounds. IMD specifications are usually expressed as a percentage of the amplifier’s output, and the lower the percentage the better.

IOC®

The IOC (Input Output Comparator) circuit compares the output signal of the amplifier with the input signal. If there is any difference other than gain, then it is considered distortion and the indicator comes on. The LED indicator will come on whenever there is distortion of 0.05% or more. This is a dynamic Proof of Performance of the amplifiers functionality. Anytime you experience distortion in your system you can view the IOC indicators. If they are not lit then you know that the amplifier is not at fault. If the IOC indicators are on, then the amplifier is in distortion.

To learn more about IOC, download and read the IOC white paper at www.crownaudio.com.

Limiter

A limiter is a dynamics processor very similar to a compressor. In fact, many compressors are capable of acting as limiters when set up properly. The primary difference is the ratio used in reducing gain. In a limiter, this ratio is set up to be as close to infinity:1 as possible (no matter how much the input signal changes, the output level should remain pretty much constant). The idea is that a limiter establishes a maximum gain setting, and prevents signals from getting any louder than that setting.

Line Level

Generally defined in the audio industry as +4 dBu (1.23 volts) for balanced “pro” gear, and .316 volts (–10 dBV) for unbalanced “semi-pro” gear. “It is best to match the levels of the gear you are using so that –10 dBV equipment isn’t directly feeding +4 dBu equipment, and vice versa. If you use gear of both levels, there are various level matching devices on the market to properly interface the items.

Linear Power Supply

A power supply that converts AC mains power for use by the amplifier by means of a conventional transformer operating at the same frequency as that of the AC mains supply (usually

50 to 60 Hz).

Loudspeaker

A transducer that converts electrical energy (the signal) into acoustical energy (sound waves).

Loudspeaker Offset Integration

A feature on some Crown amplifiers that helps reduce output clipping and off-center woofer cone movement caused by the presence of large infrasonic (subaudible) frequencies. The circuit adds a third order high-pass Butterworth filter with a –3 dB frequency of 35 Hz.

Low-Pass Filter

A filter that passes frequencies below a certain frequency and attenuates frequencies above that same frequency. It can also be called a high-cut filter.

Mic Level

The level (or voltage) of signal generated by a microphone. Typically around 2 millivolts.

Negative Feedback

If some of the output of an amplifier is made to be out of phase, and mixed back with the amp’s input signal, it will partially cancel the input, reducing the gain of the amplifier; this is called negative feedback. But, because it contains and therefore cancels any distortion introduced by the amplifier, negative feedback also has the effect of improving the linearity of the amplifier. Negative feedback can also lower output impedance, increasing damping factor, and can sometimes be made to flatten frequency response. The key to negative feedback amplifiers is careful design. Too much phase shift and the amp will be unstable, and too much feedback will cause Transient Intermodulation Distortion.

Noise

Unwanted sound, such as hiss from electronics or tape. An audio signal with an irregular, non-periodic waveform.

Noise Floor

The noise floor of a device or system is the amount of noise generated by the device itself with no signal present, it is measured in decibels. All electronic devices will generate a certain amount of noise, even a piece of wire! Minimizing the noise floor leads to expanded dynamic range, and cleaner recordings or sound production.

ODEP®

ODEP (Output Device Emulator Protection) is an analog computer simulation of the output device thermal impedance. In layman’s terms ODEP stores how much power the amplifier delivers to its load and its heatsink temperature. If the protection circuit determines that the output stage is being overstressed or cannot dissipate any further heat, then output stage drive is limited.

To learn more about ODEP, download and read the ODEP white paper at www.crownaudio.com.

Output

A connector in an audio device from which the signal comes and then feeds successive devices.

Overload

The distortion that occurs when an applied signal exceeds a system’s maximum input level.

Parallel-Mono

As implemented in Crown amplifiers, an operating mode of



the amplifier that allows a single input to feed two combined output channels in order to provide a single output with twice the current of an individual channel in Stereo or Dual mode.

Peak

On a graph of a sound wave or signal, the highest point in the waveform. The point of greatest voltage or sound pressure in a cycle.

Phase Response

The measure of displacement of a time-varying waveform between an amplifier's input and output. Expressed in degrees.

Phone Plug

A cylindrical plug, usually 1/4-inch (6.35-mm) in diameter. An unbalanced phone plug typically has a tip for the hot signal and a sleeve for the shield or ground. A balanced phone plug typically has a tip for the hot signal, a ring for the return signal, and a sleeve for the shield or ground.

Phono Plug

A coaxial plug with a central pin for the hot signal and a ring of pressure-fit tabs for the shield or ground. Phono plugs are used for unbalanced signals only. Also called an RCA plug or pin jack.

PIP™

PIP stands for Programmable Input Processor. These are optional modules that can be plugged into any PIP-compatible amplifier. There are a variety of PIP modules with varying functions. Since first introducing PIP-compatible amplifiers and PIP modules, Crown has updated the PIP standard. This affects which PIP-compatible amplifiers can host certain PIP modules. Following are descriptions of the two PIP standards. Crown's original PIP module was designed with a 22-pin edge connector, which mated with a slide-in card rail on PIP-compatible amplifiers.

PIP2™

The PIP2 standard, announced in 1998, upgraded the PIP feature set and requires both 18- and 20-pin ribbon cables which mate with a PIP2-compatible amplifier using standard ribbon connectors.

Polarity

In electronics, the relationship between two points that have opposite electric potentials (one is positive, the other negative) irrespective of time. This is not the same as being 180 degrees out of phase (although the results can be similar). Phase implies a relationship with time, polarity does not.

Potentiometer (Pot)

An electronic component that is used to provide variable control over an electronic circuit. It is usually controlled by a rotary knob which can be turned by hand; a volume control is a good example of this.

Power

Literally, the rate at which energy is consumed. Power is expressed in Watts, abbreviated W. In electrical circuits, power is determined by the amount of resistance (R) times the amount of current squared with the following expression: $P=I^2R$.

Power Amplifier

In audio, an electronic device that amplifies or increases the

power level fed into it to a level sufficient to drive a loud-speaker.

Radio Frequency Interference (RFI)

Radio-frequency electromagnetic waves induced in audio cables or equipment, causing various noises in the audio signal.

Removable Terminal Block (Buchanan®, Phoenix)

A series of screw terminal connections arranged in a line on a removable connector. Often found in three-terminal and four-terminal versions in audio applications. Often referred to by their brand name, such as "Buchanan®" and "Phoenix."

Resistance

The opposition of a circuit to a flow of direct current. Resistance is measured in ohms. The symbol Ω (omega) is often used to represent resistance. Ohm's law defines resistance as voltage (V) divided by current (I) with the following expression: $R=V/I$.

Resistor

An electronic component that opposes current flow.

Sensitivity

In audio terms, sensitivity is the minimum amount of input signal required to drive a device to its rated output level. Normally, this specification is associated with amplifiers and microphones, but FM tuners, phono cartridges, and most other types of gear have a sensitivity rating as well.

Shield

In electronic terms, a shield is a conductive enclosure, protecting its contents from magnetic and electrostatic fields. Since audio conductors and circuits tend to be extremely sensitive to such fields, shields are very important. In cabling, shields often consist of braided copper strands wrapped around the signal conductors. The amount of coverage the shield provides is directly related to the noise and hum performance of the cable. Some cables offer a shield consisting of a thin wrap of metallic sheeting, which can offer complete coverage of the encased signal conductors.

Signal-To-Noise Ratio (S/N)

The ratio in decibels between signal voltage and noise voltage. An audio component with a high S/N has little background noise accompanying the signal; a component with a low S/N is noisy.

Sine Wave

A wave following the equation $y = \sin x$, where x is degrees and y is voltage or sound pressure level. The waveform of a single frequency. The waveform of a pure tone without harmonics.

Single-Ended

An unbalanced line (see Unbalanced).

Slew Rate

Slew rate is the ability of a piece of audio equipment to reproduce fast changes in amplitude. Measured in volts per microsecond, this spec is most commonly associated with amplifiers, but in fact applies to most types of gear. Since high frequencies change in amplitude the fastest, this is where slew rate is most critical. An amp with a higher slew rate will sound "tighter" and more dynamic to our ears. Slew rates in amplifiers are often limited to useful levels to provide protection to the amplifier from Radio-Frequency Interference (RFI).

Sound Pressure Level (SPL)

The acoustic volume or perceived loudness of sound, measured in decibels. SPL is a function of a signal's amplitude.

Speakon®

A type (and brand) of multi-pin connector developed by Neutrik® which is now commonly found on speakers and amplifiers intended to be used in high power mobile applications. They have become popular because they offer a very high quality reliable connection, can handle extremely high power, are very durable, and are relatively low in cost compared to other similar connectors. Standard Speakon connectors come in four or eight conductor versions (though other configurations are available). The Speakon 8 has the same footprint as the EP8 connector and the Speakon 4 has the same footprint as XLR "D" type connectors.

Stereo (Dual)

An operating mode of an amplifier that allows channels of the amplifier to function independently.

Switching Power Supply

A power supply that first converts AC mains power to a much higher frequency by means of a switching circuit before making the power available for use within the amplifier. The primary benefits of a switching power supply are decreased overall unit weight and decreased electro-mechanical emissions.

THD (Total Harmonic Distortion)

The ratio of the power of the fundamental frequency at the output of a device versus the total power of all the harmonics in the frequency band at the output of the device. All electronic audio devices introduce some distortion to audio passed through them. The simplest form of this distortion is the addition of harmonics to the output signal. THD represents the sum of all the harmonics added by a device as a percentage of the level of the signal being measured.

Thermal Dissipation

Energy not converted to the output of an amplifier is instead dissipated by the amplifier as heat.

THX®

Refers to a series of specifications for surround sound systems. Professional THX is used in commercial movie theaters.

TLC

TLC (Thermal Limit Control) is a circuit developed by Crown which provides amplifier thermal protection. When a predetermined temperature threshold is reached, the TLC indicator begins to glow to show that the temperature sensing circuitry is starting to engage the input compressor. By compressing the input, the amplifier will not generate as much heat and will have a chance to cool down. The degree of compression is directly proportional to the amount of overheating experienced by the amplifier.

Transformer

A transformer is a device consisting of two or more coils of wire wound on a common core of magnetically permeable material. The number of turns in one coil divided by the number of turns in the other is called the turns ratio. An alternating voltage appearing across one coil will be inducted into the other coil multiplied by the turns ratio.

Transformers are used in power supplies, distributed speaker systems, and are often used to provide electrical isolation in circuits to prevent ground loops because they pass AC voltages and block DC voltages.

Transient

A non-repeating waveform, usually of much higher level than the surrounding sounds or average level. Good examples of transients include the attack of many percussion instruments, the "pluck" or attack part of a guitar note, consonants in human speech (i.e. "T"), and so on. Due to their higher-than-average level and fleeting nature, transients are difficult to record and reproduce, eating up precious headroom, and often resulting in overload distortion. Careful use of compression can help tame transients and raise average level,

although over-compression will result in a dull, squashed, flat sound to the signal.

Trim

Found on most mixers, trim controls provide the initial level setting for each channel's input gain. In most cases, trim adjusts gain of the microphone preamp, but it may also apply to line level signals.

Unbalanced

In electronics, a condition where the two legs of the circuit are not equal or opposite with respect to ground, usually because one leg is kept at ground potential. In other words: An audio signal requires two wires or conductors to function. In an unbalanced situation, one of those conductors is used to carry both signal and ground (shield). Unbalanced circuits are much more susceptible to induced noise problems than their balanced counterparts. Because of this, unbalanced lines should be kept as short as possible (under 10-15 inches (25- to 38-cm)) to minimize potential noise problems.

Unity Gain

A device or setting which does not change signal level (does not amplify or attenuate a signal) is said to be at "unity gain." Many processors are set up for unity gain; that is, they can be plugged into a system without changing its overall levels. In practice, unity gain is often a desired setting for maintaining gain staging, and for optimizing operating levels and signal to noise ratios.

Voltage

The electrical potential between two relative points in a circuit. Voltage is measured in volts (V). Ohm's law defines voltage as the product of current (I) and Resistance (R) with the following expression: $V=I \cdot R$.

VZ®

VZ (Variable Impedance) is the name of Crown's patented articulated power supply technology. VZ technology enables Crown to pack tremendous power into few rack spaces.

The VZ supply is divided into two parts. When the voltage demands are not high, it operates in a parallel mode to supply less voltage and more current. The power transistors stay cooler because they are not forced to needlessly dissipate heat. This is the normal operating mode of the VZ power supply. When the voltage requirements are high VZ switches to a series mode to produce higher voltage and less current. The amplified output signal never misses a beat and gets full voltage only when it requires it. Sensing circuitry observes the voltage of the signal to determine when to switch VZ modes. The switching circuitry is designed to prevent audible switching distortion to yield the highest dynamic transfer function.

To learn more about VZ, download and read the VZ white paper at www.crownaudio.com.

Watt

Power equates to the rate of energy transfer, or the rate of doing work. Power is measured in Watts, and the watt has become a common term in audio to describe the power handling capabilities and/or requirements of speakers, and the power delivery capabilities of amplifiers. Watts law defines power (P) as voltage (V) times current (I) with the following expression: $P=V \cdot I$.

XLR (Cannon or Three-Pin Connector)

A three-pin professional audio connector used for balanced mic and line level signals. The AES standard for wiring of XLR connectors dictates that Pin 1 be soldered to the cable shield, pin 2 be soldered to the signal hot lead, and pin 3 be soldered to the signal return lead. The name XLR was trademarked by Cannon (now owned by ITT). XLR has since evolved into a generic industry term, and many manufacturers now make this style connector.

Y-Adapter

A single cable that divides into two cables in parallel to feed one signal to two destinations.

Z

The abbreviation for impedance.



Appendix

Suggested Reading

This Appendix provides a list of suggested publications for further reading about professional audio.

Audio Systems Design and Installation

by Philip Giddings, Phillip Giddings
Paperback - 574 pages (1990)
Sams; ISBN: 0240802861

Audio Systems Technology, Level I

by James S. Brawley (Editor), Larry W. Garter, National Systems contractor, R. David Reed, National Sound Contractors Association
Paperback - 295 pages (September 1, 1998)
PROMPT Publications; ISBN: 0790611627

Audio Systems Technology #2 - Handbook For Installers And Engineers

by James S. Brawley (Editor), Ray Alden, National Systems Contractors asso, Bob Bushnell, Matt Marth, NSCA
Paperback - 415 pages (October 1, 1998)
PROMPT Publications; ISBN: 0790611635

Audio Systems Technology Level III: Handbook For Installers and Engineers

by Bob Bushnell, Melvin J. Wierenga, Melvin J. Wierenga
Paperback - 289 pages 1st edition (May 15, 2000)
Howard W Sams & Co; ISBN: 0790611783

Handbook for Sound Engineers: The New Audio Cycloped

by Glen M. Ballou (Editor). Hardcover - 1506 pages 2nd edition (January 1, 1991)
Focal Press; ISBN: 0240803310

JBL Audio Engineering for Sound Reinforcement

by John Eargle and Chris Foreman
Paperback - 452 pages 1st edition (May 2002)
Hal Leonard Publishing Corporation; ISBN 0-634-04355-2

Sound Check : The Basics of Sound and Sound Systems

by Tony Moscal
Paperback - 104 pages (July 1994)
Hal Leonard Publishing Corporation; ISBN: 079353559X

Sound Reinforcement Engineering

by Wolfgang Ahnert, Frank Steffen
Hardcover - 424 pages (March 2000)
Routledge; ISBN: 0415238706

Sound System Engineering

by Don Davis, Carolyn Davis (Contributor)
Hardcover - 665 pages 2nd edition (May 1997)
Sams; ISBN: 0240803051

Wire, Cable, and Fiber Optics for Video and Audio Engineers (McGraw-Hill's Video-Audio Engineering Series)

by Stephen H. Lampen
Paperback - 350 pages 3rd edition (September 1997)
McGraw-Hill; ISBN: 0070381348



THREE YEAR FULL WARRANTY

NORTH AMERICA SUMMARY OF WARRANTY

The Crown Audio Division of Crown International, Inc., 1718 West Mishawaka Road, Elkhart, Indiana 46517-4095 U.S.A. warrants to you, the ORIGINAL PURCHASER and ANY SUBSEQUENT OWNER of each NEW Crown product, for a period of three (3) years from the date of purchase by the original purchaser (the "warranty period") that the new Crown product is free of defects in materials and workmanship. We further warrant the new Crown product regardless of the reason for failure, except as excluded in this Warranty.

ITEMS EXCLUDED FROM THIS CROWN WARRANTY

This Crown Warranty is in effect only for failure of a new Crown product which occurred within the Warranty Period. It does not cover any product which has been damaged because of any intentional misuse, accident, negligence, or loss which is covered under any of your insurance contracts. This Crown Warranty also does not extend to the new Crown product if the serial number has been defaced, altered, or removed.

WHAT THE WARRANTOR WILL DO

We will remedy any defect, regardless of the reason for failure (except as excluded), by repair, replacement, or refund. We may not elect refund unless you agree, or unless we are unable to provide replacement, and repair is not practical or cannot be timely made. If a refund is elected, then you must make the defective or malfunctioning product available to us free and clear of all liens or other encumbrances. The refund will be equal to the actual purchase price, not including interest, insurance, closing costs, and other finance charges less a reasonable depreciation on the product from the date of original purchase. Warranty work can only be performed at our authorized service centers or at the factory. We will remedy the defect and ship the product from the service center or our factory within a reasonable time after receipt of the defective product at our authorized service center or our factory. All expenses in remedying the defect, including surface shipping costs in the United States, will be borne by us. (You must bear the expense of shipping the product between any foreign country and the port of entry in the United States and all taxes, duties, and other customs fees for such foreign shipments.)

HOW TO OBTAIN WARRANTY SERVICE

You must notify us of your need for warranty service not later than ninety (90) days after expiration of the warranty period. All components must be shipped in a factory pack, which, if needed, may be obtained from us free of charge. Corrective action will be taken within a reasonable time of the date of receipt of the defective product by us or our authorized service center. If the repairs made by us or our authorized service center are not satisfactory, notify us or our authorized service center immediately.

DISCLAIMER OF CONSEQUENTIAL & INCIDENTAL DAMAGES

YOU ARE NOT ENTITLED TO RECOVER FROM US ANY INCIDENTAL DAMAGES RESULTING FROM ANY DEFECT IN THE NEW CROWN PRODUCT. THIS INCLUDES ANY DAMAGE TO ANOTHER PRODUCT OR PRODUCTS RESULTING FROM SUCH A DEFECT. **SOME STATES DO NOT ALLOW THE EXCLUSION OR LIMITATIONS OF INCIDENTAL OR CONSEQUENTIAL DAMAGES, SO THE ABOVE LIMITATION OR EXCLUSION MAY NOT APPLY TO YOU.**

WARRANTY ALTERATIONS

No person has the authority to enlarge, amend, or modify this Crown Warranty. This Crown Warranty is not extended by the length of time which you are deprived of the use of the new Crown product. Repairs and replacement parts provided under the terms of this Crown Warranty shall carry only the unexpired portion of this Crown Warranty.

DESIGN CHANGES

We reserve the right to change the design of any product from time to time without notice and with no obligation to make corresponding changes in products previously manufactured.

LEGAL REMEDIES OF PURCHASER

THIS CROWN WARRANTY GIVES YOU SPECIFIC LEGAL RIGHTS, YOU MAY ALSO HAVE OTHER RIGHTS WHICH VARY FROM STATE TO STATE. No action to enforce this Crown Warranty shall be commenced later than ninety (90) days after expiration of the warranty period.

THIS STATEMENT OF WARRANTY SUPERSEDES ANY OTHERS CONTAINED IN THIS MANUAL FOR CROWN PRODUCTS.



WORLDWIDE SUMMARY OF WARRANTY

The Crown Audio Division of Crown International, Inc., 1718 West Mishawaka Road, Elkhart, Indiana 46517-4095 U.S.A. warrants to you, the ORIGINAL PURCHASER and ANY SUBSEQUENT OWNER of each NEW Crown1 product, for a period of three (3) years from the date of purchase by the original purchaser (the "warranty period") that the new Crown product is free of defects in materials and workmanship, and we further warrant the new Crown product regardless of the reason for failure, except as excluded in this Crown Warranty.

1 Note: If your unit bears the name "Amcron," please substitute it for the name "Crown" in this warranty.

ITEMS EXCLUDED FROM THIS CROWN WARRANTY

This Crown Warranty is in effect only for failure of a new Crown product which occurred within the Warranty Period. It does not cover any product which has been damaged because of any intentional misuse, accident, negligence, or loss which is covered under any of your insurance contracts. This Crown Warranty also does not extend to the new Crown product if the serial number has been defaced, altered, or removed.

WHAT THE WARRANTOR WILL DO

We will remedy any defect, regardless of the reason for failure (except as excluded), by repair, replacement, or refund. We may not elect refund unless you agree, or unless we are unable to provide replacement, and repair is not practical or cannot be timely made. If a refund is elected, then you must make the defective or malfunctioning product available to us free and clear of all liens or other encumbrances. The refund will be equal to the actual purchase price, not including interest, insurance, closing costs, and other finance charges less a reasonable depreciation on the product from the date of original purchase. Warranty work can only be performed at our authorized service centers. We will remedy the defect and ship the product from the service center within a reasonable time after receipt of the defective product at our authorized service center.

HOW TO OBTAIN WARRANTY SERVICE

You must notify us of your need for warranty service not later than ninety (90) days after expiration of the warranty period. All components must be shipped in a factory pack. Corrective action will be taken within a reasonable time of the date of receipt of the defective product by our authorized service center. If the repairs made by our authorized service center are not satisfactory, notify our authorized service center immediately.

DISCLAIMER OF CONSEQUENTIAL & INCIDENTAL DAMAGES

YOU ARE NOT ENTITLED TO RECOVER FROM US ANY INCIDENTAL DAMAGES RESULTING FROM ANY DEFECT IN THE NEW CROWN PRODUCT. THIS INCLUDES ANY DAMAGE TO ANOTHER PRODUCT OR PRODUCTS RESULTING FROM SUCH A DEFECT.

WARRANTY ALTERATIONS

No person has the authority to enlarge, amend, or modify this Crown Warranty. This Crown Warranty is not extended by the length of time which you are deprived of the use of the new Crown product. Repairs and replacement parts provided under the terms of this Crown Warranty shall carry only the unexpired portion of this Crown Warranty.

DESIGN CHANGES

We reserve the right to change the design of any product from time to time without notice and with no obligation to make corresponding changes in products previously manufactured.

LEGAL REMEDIES OF PURCHASER

No action to enforce this Crown Warranty shall be commenced later than ninety (90) days after expiration of the warranty period.

THIS STATEMENT OF WARRANTY SUPERSEDES ANY OTHERS CONTAINED IN THIS MANUAL FOR CROWN PRODUCTS.

**THREE YEAR
FULL WARRANTY**

Free Manuals Download Website

<http://myh66.com>

<http://usermanuals.us>

<http://www.somanuals.com>

<http://www.4manuals.cc>

<http://www.manual-lib.com>

<http://www.404manual.com>

<http://www.luxmanual.com>

<http://aubethermostatmanual.com>

Golf course search by state

<http://golfingnear.com>

Email search by domain

<http://emailbydomain.com>

Auto manuals search

<http://auto.somanuals.com>

TV manuals search

<http://tv.somanuals.com>