



K Series

Operation Manual



K1

K2

Obtaining Other Language Versions: To obtain information in another language about the use of this product, please contact your local Crown Distributor. If you need assistance locating your local distributor, please contact Crown at 574-294-8000.

This manual does not include all of the details of design, production, or variations of the equipment. Nor does it cover every possible situation which may arise during installation, operation or maintenance.

The information provided in this manual was deemed accurate as of the publication date. However, updates to this information may have occurred. To obtain the latest version of this manual, please visit the Crown website at www.crownaudio.com.

Trademark Notice: Crown and Amcron are registered trademarks of Crown International. BCA is a trademark of Crown International. Other trademarks are the property of their respective owners.

Some models may be exported under the name Amcron.®

Important Safety Instructions

- 1) Read these instructions.
- 2) Keep these instructions.
- 3) Heed all warnings.
- 4) Follow all instructions.
- 5) Do not use this apparatus near water.
- 6) Clean only with a dry cloth.
- 7) Do not block any ventilation openings. Install in accordance with the manufacturer's instructions.
- 8) Do not install near any heat sources such as radiators, heat registers, stoves, or other apparatus that produce heat.
- 9) Do not defeat the safety purpose of the polarized or grounding-type plug. A polarized plug has two blades with one wider than the other. A grounding-type plug has two blades and a third grounding prong. The wide blade or the third prong is provided for your safety. If the provided plug does not fit into your outlet, consult an electrician for replacement of the obsolete outlet.
- 10) Protect the power cord from being walked on or pinched, particularly at plugs, convenience receptacles, and the point where they exit from the apparatus.
- 11) Only use attachments/accessories specified by the manufacturer.
- 12) Use only with a cart, stand, bracket, or table specified by the manufacturer, or sold with the apparatus. When a cart is used, use caution when moving the cart/apparatus combination to avoid injury from tip-over.
- 13) Unplug this apparatus during lightning storms or when unused for long periods of time.
- 14) Refer all servicing to qualified service personnel. Servicing is required when the apparatus has been damaged in any way, such as power-supply cord or plug is damaged, liquid has been spilled or objects have fallen into the apparatus, the apparatus has been exposed to rain or moisture, does not operate normally, or has been dropped.
- 15) To reduce the risk of fire or electric shock, do not expose this apparatus to rain or moisture.



TO PREVENT ELECTRIC SHOCK DO NOT REMOVE TOP OR BOTTOM COVERS. NO USER SERVICEABLE PARTS INSIDE. REFER SERVICING TO QUALIFIED SERVICE PERSONNEL.



CAUTION
RISK OF ELECTRIC SHOCK
DO NOT OPEN

À PRÉVENIR LE CHOC ÉLECTRIQUE N'ENLEVEZ PAS LES COUVERCLES. IL N'Y A PAS DES PARTIES SERVICEABLE À L'INTÉRIEUR. TOUS REPARATIONS DOIT ÊTRE FAIRE PAR PERSONNEL QUALIFIÉ SEULMENT.



AVIS
RISQUE DE CHOC ÉLECTRIQUE
N'OUVREZ PAS

IMPORTANT

K Series amplifiers require Class 2 output wiring.



MAGNETIC FIELD

CAUTION! Do not locate sensitive high-gain equipment such as preamplifiers or tape decks directly above or below the unit. Because this amplifier has a high power density, it has a strong magnetic field which can induce hum into unshielded devices that are located nearby. The field is strongest just above and below the unit.



If an equipment rack is used, we recommend locating the amplifier(s) in the bottom of the rack and the preamplifier or other sensitive equipment at the top.

WATCH FOR THESE SYMBOLS:

The lightning bolt triangle is used to alert the user to the risk of electric shock.



The exclamation point triangle is used to alert the user to important operating or maintenance instructions.



Table of Contents

Important Safety Instructions	2	4 Operation	9
Table of Contents	3	4.1 Precautions	9
1 Welcome	4	4.2 Front Panel Controls and Indicators	10
1.1 Features	4	4.3 Back Panel Controls and Connectors	11
2 How to Use This Manual	4	5 Advanced Features and Options	12
3 Setup	5	5.1 Protection Systems	12
3.1 Unpack Your Amplifier	5	5.1.1. TLC	12
3.2 Install Your Amplifier	5	5.1.2 Out-of-band Filtering	12
3.3 Ensure Proper Cooling	5	5.1.3 Inrush Limiting	12
3.4 Choose Input Wire and Connectors	6	5.1.4 Fuse	
3.5 Choose Output Wire and Connectors	6	5.2 Advanced Features	12
3.6 Set Up and Wire Your System	7	6 Troubleshooting	13
3.6.1 Set the Mode Modes Switches	7	7 Specifications	14
3.6.2 Set Input Sensitivity	7	8 Service	16
3.6.3 Stereo Mode	7	8.1 Worldwide Service	16
3.6.4 Bridge-Mono Mode	7	8.2 US and Canada Service	16
3.6.5 "Y" Mono Input to Dual Outputs	8	8.2.1 Service at a US or Canada Service Center	16
3.6.6 "Y" Mono Input to Bridge-Mono Output	8	8.2.2 Factory Service	16
3.7 Connect to AC Mains	9	8.2.3 Factory Service Shipping Instructions	16
3.8 Startup Procedure	9	9 Warranty	17
		Crown Factory Service Information Form	19



K1	*1 kHz Power
2-ohm Stereo (per channel)	750W
4-ohm Stereo (per channel)	550W
8-ohm Stereo (per channel)	350W
4-ohm Bridge-Mono	1,500W
8-ohm Bridge-Mono	1,100W

*1 kHz Power: refers to maximum average power in watts at 1 kHz with 0.1% or less TRUE THD.

K2	*1 kHz Power
2-ohm Stereo (per channel)	1,250W
4-ohm Stereo (per channel)	800W
8-ohm Stereo (per channel)	500W
4-ohm Bridge-Mono	2,500W
8-ohm Bridge-Mono	1,600W

*1 kHz Power: refers to maximum average power in watts at 1 kHz with 0.1% or less TRUE THD.

1 Welcome

Congratulations on purchasing a *Crown K Series* amplifier. It is designed to provide very high power in a lightweight package, without using a cooling fan. This means your amp runs quieter (no fan noise) and cleaner (no need for filters). The K Series amplifiers are very energy-efficient as well.

Modern power amplifiers are sophisticated pieces of engineering capable of producing extremely high power levels. They must be treated with respect and correctly installed if they are to provide the many years of reliable service for which they were designed.

In addition, the K Series amplifiers include a number of features which require some explanation before they can be used to their maximum advantage.

Please take the time to study this manual so that you can obtain the best possible service from your amplifier.

1.1 Features

- Accurate, uncolored sound with very low distortion.
- High damping factor for tight, clean bass response.
- Advanced design for energy conservation.

- Versatile, handling a wide range of speaker impedances and outputs.
- Switchable input sensitivity.
- “Soft Start” feature prevents the amplifier from drawing large currents when it is first turned on.
- Can be mounted in standard 19-inch (48.3-cm) rack. Uniquely molded, cast-aluminum front panel provides exceptional air circulation.
- Exclusive *BCA™* (Balanced Current Amplifier) power design provides high efficiency for quiet, fan-free operation.
- Advanced protection circuitry guards against shorted outputs, open circuits, DC, mismatched loads, general overheating, high-frequency overloads and internal faults.
- Mono mode switches allow you to set up your amps/speakers in the configuration that best suits your needs, with combined amp inputs, combined amp outputs, or both.
- Patented front-panel design.
- Backed by the industry’s **ONLY** three-year, no-fault, fully transferable warranty.

2 How to Use This Manual

This manual provides you with the necessary information to safely and correctly set up and operate your amplifier. It does not cover every aspect of installation, setup or operation that might occur under every condition. For additional information, please consult Crown’s *Amplifier Application Guide* (available online at www.crownaudio.com), Crown Technical Support, your system installer or retailer.

We strongly recommend you read all instructions, warnings and cautions contained in this manual. Also, for your protection, please send in your warranty registration card today. And save your bill of sale—it’s your official proof of purchase.

3 Setup

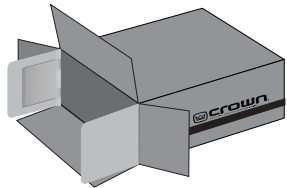

3.1 Unpack Your Amplifier

Please unpack and inspect your amplifier for any damage that may have occurred during transit. If damage is found, notify the transportation company immediately. Only you can initiate a claim for shipping damage. Crown will be happy to help. Save the shipping carton as evidence of damage for the shipper's inspection.

We also recommend that you save all packing materials so you will have them if you ever need to transport the unit. **Never ship the unit without the factory pack.**

YOU WILL NEED (not supplied):

- Input wiring cables
- Output wiring cables

Rack for mounting amplifier (or a stable surface for stacking)



WARNING: Before you start to set up your amplifier, make sure you read and observe the Important Safety Instructions found at the beginning of this manual.

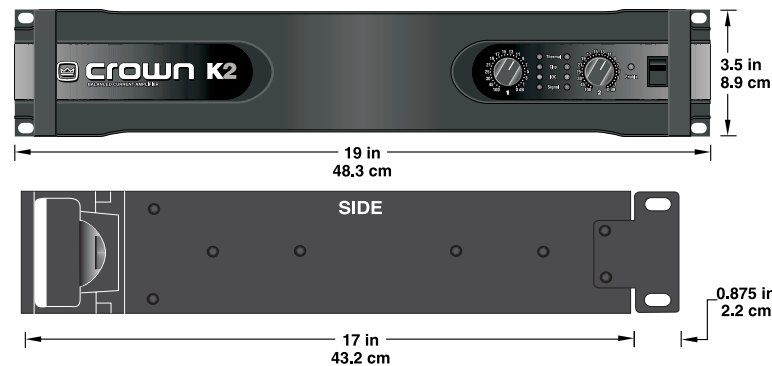

Figure 3.1 Dimensions

3.2 Install Your Amplifier



CAUTION: Before you begin, make sure your amplifier is disconnected from the power source, with power switch in the “off” position and all level controls turned completely down (counterclockwise).

Use a standard 19-inch (48.3 cm) equipment rack. See Figure 3.1 for amplifier dimensions.

You may also stack amps without using a cabinet.

NOTE: When transporting, amplifiers should be supported at both front and back.

3.3 Ensure Proper Cooling

The K Series amplifier is convection cooled and uses no fan. If ambient temperatures are high, The TLC indicators may start to illuminate, showing that the amplifier is becoming hot.

To prevent this, space the amplifiers in the rack, allowing the top and bottom covers to act as radiators (Figure 3.2). In extreme conditions, add fans to direct air onto any surface of the amplifier.



Figure 3.2 Spacing the Amplifiers in the Rack Improves Cooling

3 Setup

3.4 Choose Input Wire and Connectors

Crown recommends using pre-built or professionally wired, balanced line (two-conductor plus shield), 22-24 gauge cables and connectors. Use either 3-pin male XLR connectors or TRS phone connectors.

Figure 3.3 shows connector pin assignments for balanced wiring, and Figure 3.4 shows connector pin assignments for unbalanced wiring.



NOTE: Custom wiring should only be performed by qualified personnel.

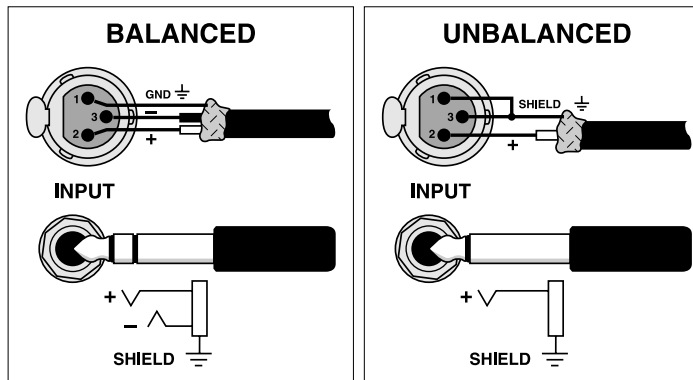

Figure 3.3 Balanced Input Connector Wiring

Figure 3.4 Unbalanced Input Connector Wiring

3.5 Choose Output Wire and Connectors

Crown recommends using pre-built or professionally wired, high-quality, two-conductor, heavy gauge speaker wire. Use bare wire, a dual banana plug or spade lugs on the amplifier end of each speaker cable (Figure 3.5). To prevent the possibility of short-circuits, wrap or otherwise insulate exposed loudspeaker cable connectors.

Using the guidelines below, select the appropriate size of wire based on the distance from amplifier to speaker.

Distance	Wire Size
up to 25 ft.	16 gauge
26-40 ft.	14 gauge
41-60 ft.	12 gauge
61-100 ft.	10 gauge
101-150 ft.	8 gauge
151-250 ft.	6 gauge

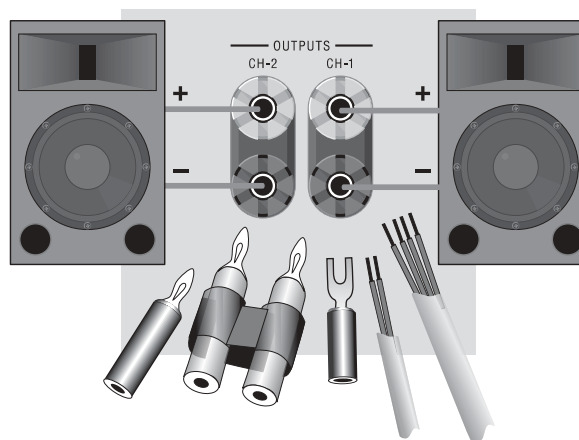

Figure 3.5 Output Connector Wiring



CAUTION: Never use shielded cable for output wiring.

3 Setup

3.6 Set Up and Wire Your System

First, turn down the Level controls (fully counterclockwise) and turn off the amplifier.

3.6.1 Set the Mono Modes Switches

To run in Stereo Mode: On the back panel, set the Bridge Output switch and the “Y” Input switch OFF.

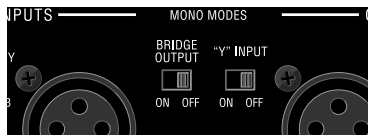

Figure 3.6 Mono Modes Switches

If you want to give up stereo capabilities in order to drive your speakers louder, set the Bridge Output switch to ON. Then a single input will feed a single output with twice the voltage of stereo mode. You might use this configuration if you are running a distributed sound system from the K Series amp.

If you want to feed a mono audio signal to two channels, each with its own level control, set the “Y” Input switch ON. This connects both inputs in parallel. You might use this setup if you’re running a monitor speaker on one channel and a main speakers stack on the other channel, and you want to feed them the same signal.

If you want daisy-chained inputs fed to a double-voltage output, set the Bridge Output switch ON and the “Y” Input switch ON. For example, connect the input signal to the CH-1 XLR connector and use the CH-2 XLR connector plus the two 1/4-inch phone jacks for daisy-chained outputs that feed other power amplifiers.

3.6.2 Set Input Sensitivity

Set the Input Sensitivity switches of each channel to the desired setting (see Figure 3.7). Two choices are available: 1.4V for full rated output (33 dB gain), or a fixed voltage gain of 26 dB.

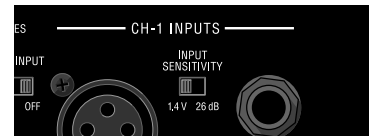

Figure 3.7 Input Sensitivity Switch

3.6.3 Stereo Mode

See Figure 3.8.

INPUTS: Connect input wiring to both channels.

OUTPUTS: Maintain proper polarity (+/-) on output connectors.

Connect Channel 1 positive (+) speaker load to Channel 1 positive terminal of amp; repeat for negative (-). Repeat Channel 2 wiring as for Channel 1.

3.6.4 Bridge-Mono Mode

See Figure 3.9.

Use this configuration if you want to give up stereo capabilities in order to drive your speakers louder.

On the back panel, set the Bridge Output switch ON.

INPUTS: Connect input wiring to Channel 1 only.

OUTPUTS: Connect the speaker across the positive terminals of each channel. **Do not use the negative terminals (black binding posts) when the amp is being operated in Bridge-Mono mode.**

NOTE: The Channel 2 level control should be set fully counter-clockwise when operating the amplifier in Bridge-Mono mode.

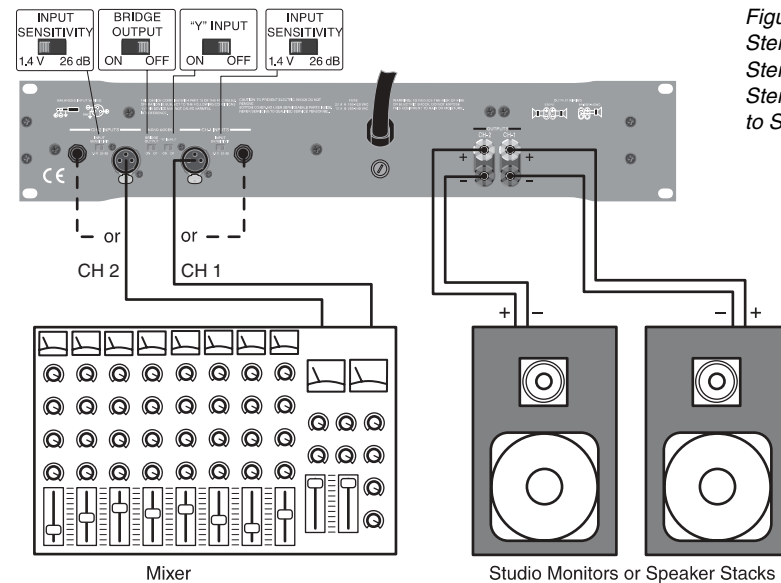

Figure 3.8 Stereo Wiring: Stereo Inputs, Stereo Output to Speakers

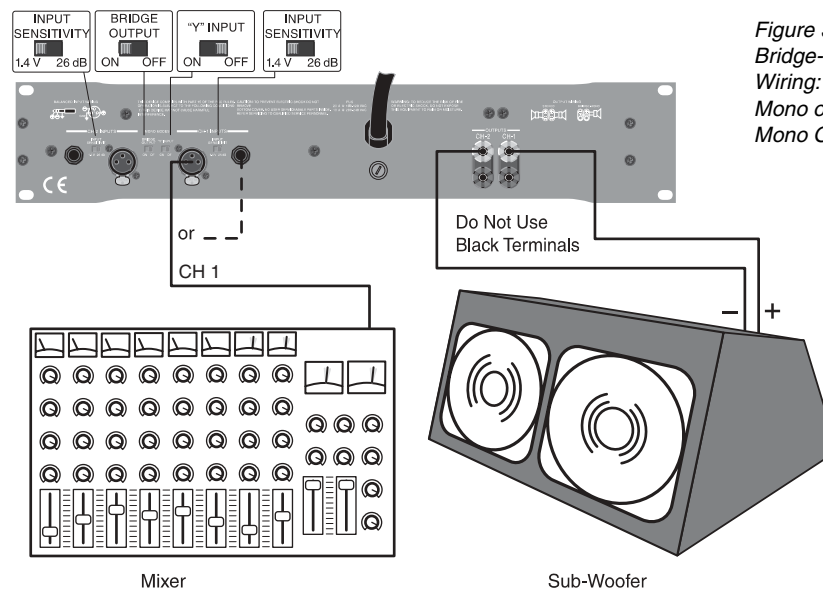

Figure 3.9 Bridge-Mono Wiring: Mono or Stereo In, Mono Out

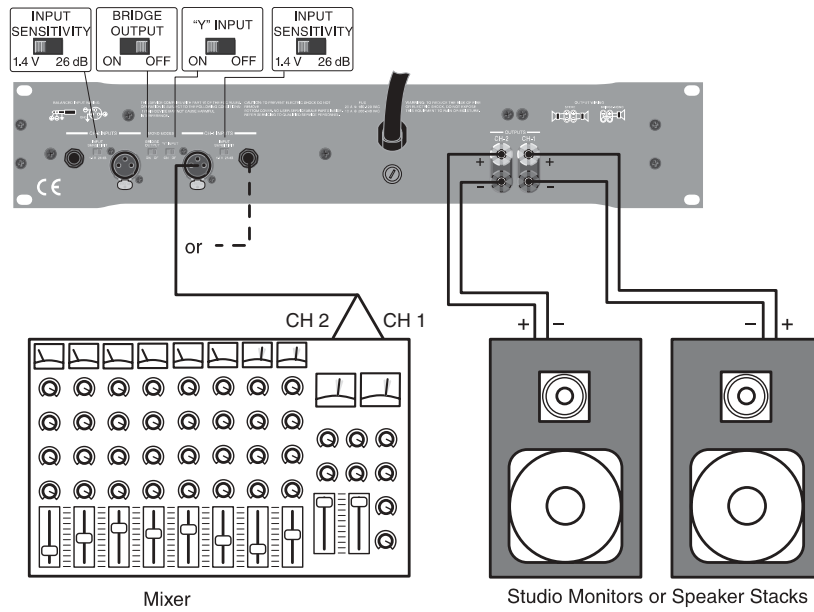

Figure 3.10
Wiring for "Y" Mono Input,
Dual Output

3.6.5 "Y" Mono Input to Dual Outputs

If you want to feed a mono audio signal to two channels, each with its own level control, set the "Y" Input switch ON. This connects both inputs in parallel. You might use this setup if you're running a monitor speaker on one channel and a main speakers stack on the other channel, and you want to feed them the same signal.

See Figure 3.10.

INPUTS: Connect input wiring to one channel.

OUTPUTS: Maintain proper polarity (+/-) on output connectors.

Connect Channel 1 positive (+) speaker load to Channel 1 positive terminal of amp; repeat for negative (-). Repeat Channel 2 wiring as for Channel 1.

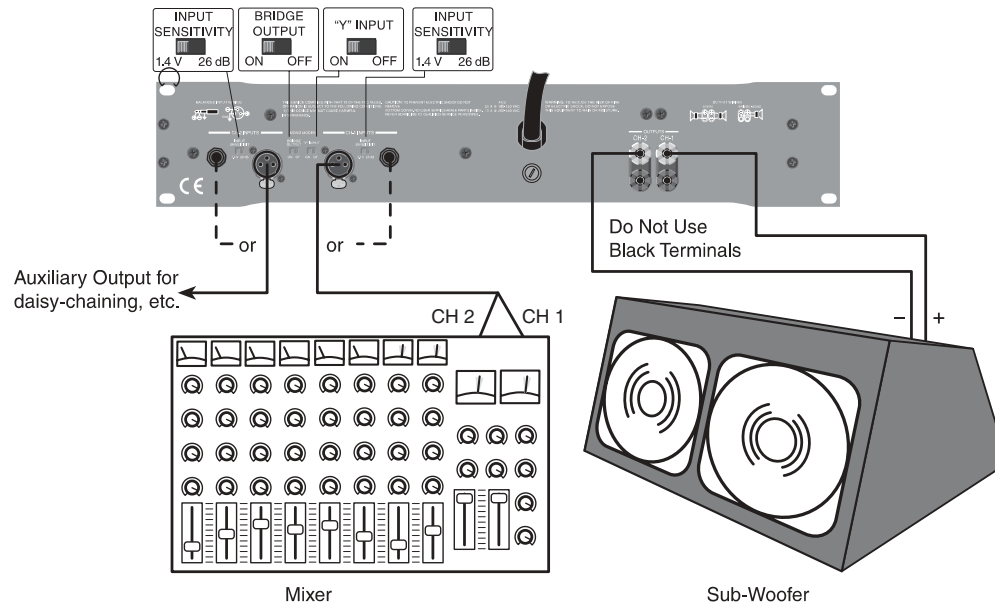

Figure 3.11
Wiring for "Y" Mono Input,
Bridge-Mono Output

3.6.6 "Y" Mono Input to Bridge-Mono Output

If you want daisy-chained inputs fed to a double-voltage output, set the Bridge Output switch ON and the "Y" Input switch ON.

See Figure 3.11.

For example, connect the input signal to the CH-1 XLR connector and use the CH-2 XLR connector plus the two 1/4-inch phone jacks for daisy-chained outputs that feed other power amplifiers.

NOTE: Crown provides a reference of wiring pin assignments for commonly used connector types in the *Crown Amplifier Application Guide* available on the web at www.crownaudio.com.

3 Setup



3.7 Connect to AC Mains

Connect your amplifier's power cord to the AC mains power source (power outlet).

WARNING: The third prong of this connector (ground) is an important safety feature. Do not attempt to disable this ground connection by using an adapter or other methods.

Amplifiers don't create energy. The AC mains voltage and current must be sufficient to deliver the power you expect. You must operate your amplifier from an AC mains power source with not more than 10% variation above or below the amplifier's specified line voltage and within the specified frequency requirements (indicated on the amplifier's back panel label). If you are unsure of the output voltage of your AC mains, please consult your electrician.

3.8 Startup Procedure

Use the following procedure when first turning on your amplifier:

1. Turn down the level of your audio source.
2. Turn down the Level controls of the amplifier.
3. Turn on the Power switch. The Enable indicator next to the Power switch should glow.
4. Turn up the level of your audio source to an optimum level.
5. Turn up the Level controls on the amplifier until the desired loudness or power level is achieved.
6. Turn down the level of your audio source to its normal range.

If you ever need to make any wiring or installation changes, **don't forget to disconnect the power cord.**

For help with determining your system's optimum gain structure (signal levels) please refer to the Crown *Amplifier Application Guide*, available online at www.crownaudio.com.

4 Operation

4.1 Precautions

Your amplifier is protected from internal and external faults, but you should still take the following precautions for optimum performance and safety:

1. Before use, your amplifier must be configured for proper operation as described in the Setup section of this manual. Improper wiring can result in serious operating difficulties. For advanced setup techniques, consult Crown's *Amplifier Application Guide* available online at www.crownaudio.com.
 2. Use care when making connections, selecting signal sources and controlling the output level. The load you save may be your own!
 3. Do not short the ground lead of an output cable to the input signal ground. This may form a ground loop and cause oscillations.
 4. Never connect the output to a power supply, battery or power main. Electrical shock may result.
 5. Tampering with the circuitry, or making unauthorized circuit changes may be hazardous and invalidates all agency listings.
 6. Do not operate the amplifier with the Clip LED constantly flashing.
 7. Do not overdrive the mixer, which will cause clipped signal to be sent to the amplifier. Such signals will be reproduced with extreme accuracy, and loudspeaker damage may result.
 8. Do not operate the amplifier with less than the rated load impedance. Due to the amplifier's output protection, such a configuration may result in premature clipping and speaker damage.
- Crown is not liable for damage that results from overdriving other system components.

4 Operation

4.2 Front Panel Controls and Indicators

Figure 4.1 below points out the controls, indicators and connectors on the front panel of the K Series amplifiers. The K1 and K2 look identical except for product nameplates and fuse specifications.

A. Level Controls

The Level controls, one per channel, adjust the input attenuation from 0 dB to 100 dB.

B. Indicators

Figure 4.2 shows a close up view of the indicator LEDs (4 per channel).

TLC: The TLC (thermal level control) indicators turn on with a dim glow a little before the amplifier needs help dissipating heat. This forewarning gives you a chance to turn on a fan or other auxiliary cooling (if available), or turn down the level controls of the amplifier. If you do neither, the amplifier will automatically

begin to protect itself with its TLC protection system by subtly and dynamically reducing the gain as needed. The TLC indicators gradually turn brighter as the TLC protection becomes greater.

Clip: Turns on when distortion becomes audible in the amplifier output.

IOC: The yellow Input /Output Comparator indicators turn on when distortion reaches 0.05%, which is well before the distortion is audible.

Signal: The green Signal indicators flash dimly when a very low-level signal (as low as 10 mW) is present in the output. They flash brightly when a louder signal (at least 1 watt) is present at the output.

C. Enable Indicator

The green Enable indicator turns on when the amplifier has been turned on and has power. When first turned on, there will be a 2-second delay while the amplifier performs a

quick start-up test. Then the Enable indicator will turn on to its full brightness. If no signal is present, the Enable indicator will switch to a dimmer green.

D. Power Switch

Amplifier is on when the top half of the switch is depressed.

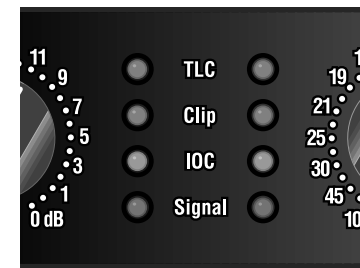

Figure 4.2 Front Panel Indicators



Figure 4.1 Front and Back Panel Controls, Indicators and Connectors

4 Operation

4.3 Back Panel Controls and Connectors

Figure 4.3 below points out the controls and connectors on the back panel of the K Series amplifiers. The K1 and K2 look identical except for product nameplates and fuse specifications.

E. Bridge Output Switch

This switch selects whether or not the output signal is bridged across the two channels. To operate the amplifier in bridge-mono mode, set this switch to ON. To operate the amplifier in dual mode, set this switch to OFF. See Section 3.6.1 for more detail.

F. "Y" Input Switch

If you want to feed a mono audio signal to two channels, each with its own level control, set the "Y" input switch to ON. This connects the

input signals of both channels together, in parallel. To operate in dual mode, set this switch to OFF. See Section 3.6.1 for more detail.

G. XLR-type Input Connector

This is a female XLR-type connector, one per channel, that accepts a balanced or unbalanced input signal. See Section 3.4 for pin assignments.

H. Input Sensitivity Switch

This switch selects between 1.4V sensitivity or 26 dB gain. See Section 3.6.2 for more detail.

I. Phone Jack Input Connector

This is a 1/4-inch phone jack connector, one per channel, that accepts a balanced or unbalanced input signal. See Section 3.4 for terminal assignments.

J. Power Fuse

This fuse protects the high-voltage power supply.

K. Power Cord

This permanently attached cable conducts the AC mains electricity to the amplifier.

L. Output Connectors

These 5-way binding-post connectors (one pair per channel) provide the amplifier output signal for connection to loudspeakers. The load can be connected in stereo (one load per channel) or in bridge mono (one load across the positive terminals of both channels). When using bridge-mono mode, be sure to set the Bridge Output switch to ON. See Sections 3.6.3 and 3.6.4 for details.

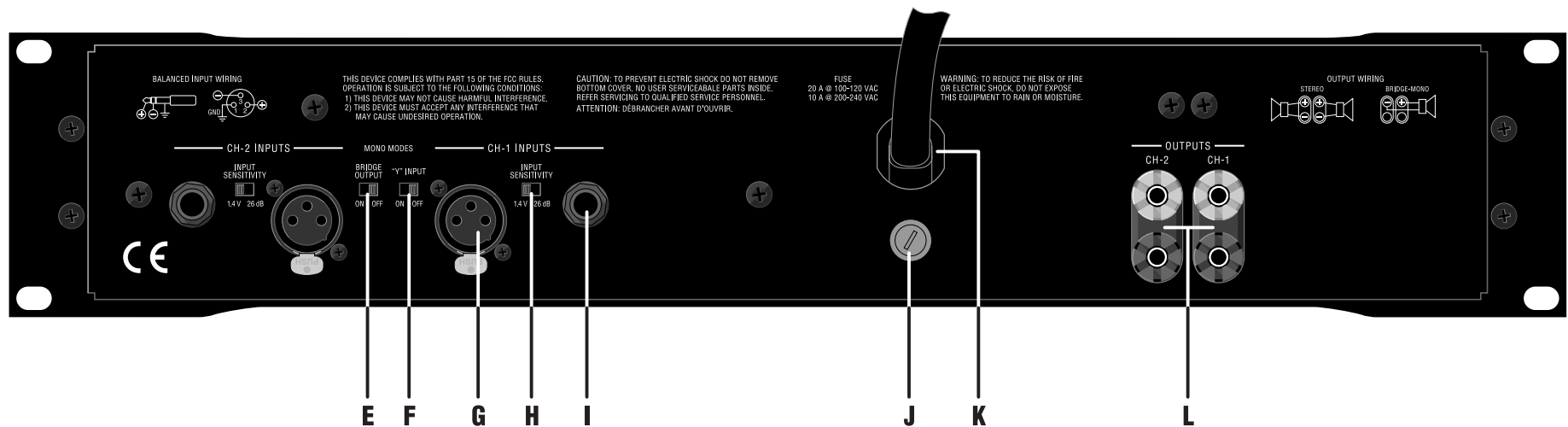

Figure 4.3 Back Panel Controls and Connectors

5 Advanced Features

NOTE: For detailed information about these Crown amplifier features, please consult the *Crown Amplifier Application Guide*, available on the Crown website at www.crownaudio.com.

5.1 Protection Systems

Your Crown amplifier provides extensive protection systems, including protection against shorted outputs, open circuits, DC, mismatched loads, general overheating, high-frequency overloads and internal faults.

5.1.1 TLC

If the amplifier starts to overheat, the thermal level control system will subtly and dynamically reduce the gain as needed. Transformer overheating (extremely unlikely) will result in a temporary shutdown. When the amplifier has cooled to a safe temperature, the transformer will automatically reset itself.

5.1.2 Out-of-band Filtering

An 8-Hz high-pass filter protects the amplifier and loads from subsonic frequencies. A 30 kHz low-pass filter offers protection from ultrasonic frequencies.

5.1.3 Inrush Limiting

The “soft-start” feature prevents the amplifier from drawing a large inrush current when it is first turned on.

5.1.4 Fuse

A fuse is provided to protect the power supplies from excess current. It is located on the back panel below the power cord.

K-Series amplifiers that are configured to use 100-120 VAC power should use the following fuses:

K2: 20-amp fuse
K1: 15-amp fuse.

K-Series amplifiers that are configured to use 200-250 VAC should use the following fuses:

K2: 10-amp fuse.
K1: 8-amp fuse.

5.2 Advanced Features

- BCA (Balanced Current Amplifier) technology allows high levels of power output without all the associated heat found in a conventional amplifier. This highly efficient design works without using a cooling fan.
- Accurate, uncolored sound with very low distortion.
- High damping factor for tight, clean bass response.
- Advanced design for energy conservation.
- Versatile, handling a wide range of speaker impedances and outputs.
- Switchable input sensitivity.
- “Soft Start” feature prevents the amplifier from drawing large currents when it is first turned on.
- Can be mounted in standard 19-inch (48.3-cm) rack. Uniquely molded, cast-aluminum front panel provides exceptional air circulation.
- Advanced protection circuitry guards against shorted outputs, open circuits, DC, mismatched loads, general overheating, high-frequency overloads and internal faults.
- Mono mode switches allow you to set up your amps/speakers in the configuration that best suits your needs, with combined amp inputs, combined amp outputs, or both.
- Backed by the industry's ONLY three-year, no-fault, fully transferable warranty.

6 Troubleshooting





TLC	●	 Enable	<p>CONDITION: No power to the amplifier.</p> <p><i>POSSIBLE REASON:</i></p> <ul style="list-style-type: none"> The amplifier's Power switch is off. The amplifier is not plugged into the power receptacle. The amplifier's low-voltage power supply fuse has blown. Return amp to Crown or an authorized Crown Service Center for servicing.
Clip	●		
IOC	●		
Signal	●		

TLC	○	 Enable	<p>CONDITION: Input signal but no sound.</p> <p><i>POSSIBLE REASON:</i></p> <ul style="list-style-type: none"> The amplifier has just been turned on and is still in the 4-second turn-on delay. Speakers not connected.
Clip	○		
IOC	○		
Signal	⊗		

TLC	○	 Enable	<p>CONDITION: Distorted sound.</p> <p><i>POSSIBLE REASON:</i></p> <ul style="list-style-type: none"> Input signal level is too high. Turn down your amplifier level controls. NOTE: Your amplifier should never be operated at a level which causes the Clip LED to flash constantly. Load is wired incorrectly or Bridge Mono Switch is set incorrectly. Check both. <p>Note: If sound is distorted but clip LED is not flashing, check mixer levels and gain staging, mixer clip lights, and pads built into microphones.</p>
Clip	⊗		
IOC	⊗		
Signal	⊗		

TLC	●	 Enable	<p>CONDITION: No input signal.</p> <p><i>POSSIBLE REASON:</i></p> <ul style="list-style-type: none"> Input signal level is very low. Level controls are turned down. Input cables are not connected.
Clip	●		
IOC	●		
Signal	●		

TLC	☀	 Enable	<p>CONDITION: TLC indicator glows brightly.</p> <p><i>POSSIBLE REASON:</i></p> <ul style="list-style-type: none"> The amplifier is protecting itself with the thermal level control system. Turn on a fan or turn down the level controls.
Clip	○		
IOC	○		
Signal	⊗		

Key		Lit
		Off
		Flashing
		Lit/Flashing/Off

7 Specifications

Minimum Guaranteed Power	K1	K2
120 VAC, 60 Hz Units, Stereo mode, per channel, both channels driven		
1 kHz with 0.1% THD		
Stereo, 2 ohms per ch.	750W	1,250W
Stereo, 4 ohms per ch.	550W	800W
Stereo, 8 ohms per ch.	350W	500W
120 VAC, 60 Hz Units, Bridge mono mode		
1 kHz with 0.1% THD		
4 ohms	1,500W	2,500W
Performance		
	K1	K2
Frequency Response (at 1 watt, 20 Hz - 20 kHz)	± 0.25 dB	± 0.25 dB
Signal to Noise Ratio below rated power (20 Hz to 20 kHz)	> 100 dB	> 100 dB
Damping Factor: 10 Hz to 400 Hz	> 3000	> 3000
Crosstalk (below rated power, 20 Hz to 1 kHz)	> 60 dB	> 60 dB
Input Impedance nominally balanced, nominally unbalanced		
	20 k ohms, 10 k ohms	20 k ohms, 10 k ohms
Load Impedance (Note: Safe with all types of loads)		
Stereo		
Bridge Mono	2-8 ohms	2-8 ohms
	4 ohms	4 ohms
Voltage Gain (at maximum level setting)		
1.4V sensitivity		
26 dB gain	31.5 dB	33.1 dB
	26 dB	26 dB
Required AC Mains		
	50/60 Hz, 100-250 VAC (+10%, -15%)	50/60 Hz, 100-250 VAC (+10%, -15%)

7 Specifications

Performance (continued)	K1	K2
Cooling	Convection cooling	Convection cooling
Dimensions		
Width	EIA Standard 19-inch (48.3 cm) rack mount (EIA RS-310-B)	EIA Standard 19-inch (48.3 cm) rack mount (EIA RS-310-B)
Height	3.5 inches (8.9 cm)	3.5 inches (8.9 cm)
Depth	16 inches (40.6 cm)	16 inches (40.6 cm)
Weight		
Net Weight	32 pounds (14.6 kg)	38 pounds (17.3kg)

8 Service

Crown amplifiers are quality units that rarely require servicing. Before returning your unit for servicing, please contact Crown Technical Support to verify the need for servicing.

This unit has very sophisticated circuitry which should only be serviced by a fully trained technician. This is one reason why each unit bears the following label:



CAUTION: To prevent electric shock, do not remove covers. No user serviceable parts inside. Refer servicing to a qualified technician.

8.1 Worldwide Service

Service may be obtained from an authorized service center. (Contact your local Crown/Amcron representative or our office for a list of authorized service centers.) To obtain service, simply present the bill of sale as proof of purchase along with the defective unit to an authorized service center. They will handle the necessary paperwork and repair.

Remember to transport your unit in the original factory pack.

8.2 US and Canada Service

Service may be obtained in one of two ways: from an authorized service center or from the factory. You may choose either. It is important that you have your copy of the bill of sale as your proof of purchase.

8.2.1 Service at a US or Canada Service Center

This method usually saves the most time and effort. Simply present your bill of sale along with the defective unit to an authorized service center to obtain service. They will handle the necessary paperwork and repair. Remember to transport the unit in the original factory pack. A list of authorized service centers in your area can be obtained from the Crown website at www.crownaudio.com, or by calling Crown Customer Service.

8.2.2 Factory Service

To obtain factory service, fill out the service information page found in the back of this manual and send it along with your proof of purchase and the defective unit to the Crown factory.

For warranty service, we will pay for ground shipping both ways in the United States. Contact Crown Customer Service to obtain prepaid shipping labels prior to sending the unit. Or, if you prefer, you may prepay the cost of shipping, and Crown will reimburse you. Send copies of the shipping receipts to Crown to receive reimbursement.

Your repaired unit will be returned via UPS ground. Please contact us if other arrangements are required.

8.2.3 Factory Service Shipping Instructions:

1. Before sending a Crown product to the factory for service, first call the Crown Service Department for a return authorization (RA) number.
2. Be sure to fill out the service information form that follows and enclose it with your shipment, either inside the box or in a packing slip envelope securely attached to the outside of the shipping carton. Do not send the service information form separately. If you are sending the unit from a Shipping Center, we recommend taping the form to the product. We also recommend recording the serial number and model before shipping for your reference.
3. Keep a copy of the serial number and model.

To ensure the safe transportation of your unit to the factory, ship it in an original factory packing container. If you don't have the original carton, you may obtain a product service foam-in-place shipping pack from the Crown Factory Service Department at the number listed below. For non-warranty service, you may also provide

your own shipping pack, however we still recommend using a Crown Supplied Shipping Container. Minimum recommended requirements for materials are as follows: 275 P.S.I. burst test Double-Wall carton that allows for 2-inch solid Styrofoam on all six sides of unit or 3 inches of plastic bubble wrap on all six sides of unit; securely seal the package with an adequate carton sealing tape. Do not use light boxes or "peanuts." Damage caused by poor packing cannot be covered under warranty.

4. Do not ship the unit in any kind of cabinet (wood or metal). Ignoring this warning may result in extensive damage to the unit and the cabinet. Accessories are not needed—do not send the product documentation, cables and other hardware.

If you have any questions, please contact Crown Factory Service.

Crown Factory Service

1718 W. Mishawaka Rd.,
Elkhart, Indiana 46517 U.S.A.

Telephone: 574-294-8200
800-342-6939 (North America,
Puerto Rico, and Virgin Islands only)

Facsimile:

574-294-8301 (Technical Support)
574-294-8124 (Factory Service)

Internet:

<http://www.crownaudio.com>

9 Warranty



SUMMARY OF WARRANTY

Crown International, 1718 West Mishawaka Road, Elkhart, Indiana 46517-4095 U.S.A. warrants to you, the ORIGINAL PURCHASER and ANY SUBSEQUENT OWNER of each NEW Crown product, for a period of three (3) years from the date of purchase by the original purchaser (the "warranty period") that the new Crown product is free of defects in materials and workmanship. We further warrant the new Crown product regardless of the reason for failure, except as excluded in this Warranty.

ITEMS EXCLUDED FROM THIS CROWN WARRANTY

This Crown Warranty is in effect only for failure of a new Crown product which occurred within the Warranty Period. It does not cover any product which has been damaged because of any intentional misuse, accident, negligence, or loss which is covered under any of your insurance contracts. This Crown Warranty also does not extend to the new Crown product if the serial number has been defaced, altered, or removed.

WHAT THE WARRANTOR WILL DO

We will remedy any defect, regardless of the reason for failure (except as excluded), by repair, replacement, or refund. We may not elect refund unless you agree, or unless we are unable to provide replacement, and repair is not practical or cannot be timely made. If a refund is elected, then you must make the defective or malfunctioning product available to us free and clear of all liens or other encumbrances. The refund will be equal to the actual purchase price, not including inter-

UNITED STATES & CANADA

est, insurance, closing costs, and other finance charges less a reasonable depreciation on the product from the date of original purchase. Warranty work can only be performed at our authorized service centers or at the factory. Warranty work for some products can only be performed at our factory. We will remedy the defect and ship the product from the service center or our factory within a reasonable time after receipt of the defective product at our authorized service center or our factory. All expenses in remedying the defect, including surface shipping costs in the United States, will be borne by us. (You must bear the expense of shipping the product between any foreign country and the port of entry in the United States including the return shipment, and all taxes, duties, and other customs fees for such foreign shipments.)

HOW TO OBTAIN WARRANTY SERVICE

You must notify us of your need for warranty service within the warranty period. All components must be shipped in a factory pack, which, if needed, may be obtained from us free of charge. Corrective action will be taken within a reasonable time of the date of receipt of the defective product by us or our authorized service center. If the repairs made by us or our authorized service center are not satisfactory, notify us or our authorized service center immediately.

DISCLAIMER OF CONSEQUENTIAL AND INCIDENTAL DAMAGES

YOU ARE NOT ENTITLED TO RECOVER FROM US ANY INCIDENTAL DAMAGES RESULTING

FROM ANY DEFECT IN THE NEW CROWN PRODUCT. THIS INCLUDES ANY DAMAGE TO ANOTHER PRODUCT OR PRODUCTS RESULTING FROM SUCH A DEFECT. SOME STATES DO NOT ALLOW THE EXCLUSION OR LIMITATIONS OF INCIDENTAL OR CONSEQUENTIAL DAMAGES, SO THE ABOVE LIMITATION OR EXCLUSION MAY NOT APPLY TO YOU.

WARRANTY ALTERATIONS

No person has the authority to enlarge, amend, or modify this Crown Warranty. This Crown Warranty is not extended by the length of time which you are deprived of the use of the new Crown product. Repairs and replacement parts provided under the terms of this Crown Warranty shall carry only the unexpired portion of this Crown Warranty.

DESIGN CHANGES

We reserve the right to change the design of any product from time to time without notice and with no obligation to make corresponding changes in products previously manufactured.

LEGAL REMEDIES OF PURCHASER

THIS CROWN WARRANTY GIVES YOU SPECIFIC LEGAL RIGHTS, YOU MAY ALSO HAVE OTHER RIGHTS WHICH VARY FROM STATE TO STATE. No action to enforce this Crown Warranty shall be commenced after expiration of the warranty period.

THIS STATEMENT OF WARRANTY SUPERSEDES ANY OTHERS CONTAINED IN THIS MANUAL FOR CROWN PRODUCTS. 12/01

9 Warranty



WORLDWIDE EXCEPT USA & CANADA

SUMMARY OF WARRANTY

Crown International, 1718 West Mishawaka Road, Elkhart, Indiana 46517-4095 U.S.A. warrants to you, the ORIGINAL PURCHASER and ANY SUBSEQUENT OWNER of each NEW Crown1 product, for a period of three (3) years from the date of purchase by the original purchaser (the "warranty period") that the new Crown product is free of defects in materials and workmanship, and we further warrant the new Crown product regardless of the reason for failure, except as excluded in this Warranty.

¹ Note: If your unit bears the name "Amcron," please substitute it for the name "Crown" in this warranty.

ITEMS EXCLUDED FROM THIS CROWN-WARRANTY

This Crown Warranty is in effect only for failure of a new Crown product which occurred within the Warranty Period. It does not cover any product which has been damaged because of any intentional misuse, accident, negligence, or loss which is covered under any of your insurance contracts. This Crown Warranty also does not extend to the new Crown product if the serial number has been defaced, altered, or removed.

WHAT THE WARRANTOR WILL DO

We will remedy any defect, regardless of the reason for failure (except as excluded), by repair,

replacement, or refund. We may not elect refund unless you agree, or unless we are unable to provide replacement, and repair is not practical or cannot be timely made. If a refund is elected, then you must make the defective or malfunctioning product available to us free and clear of all liens or other encumbrances. The refund will be equal to the actual purchase price, not including interest, insurance, closing costs, and other finance charges less a reasonable depreciation on the product from the date of original purchase. Warranty work can only be performed at our authorized service centers. We will remedy the defect and ship the product from the service center within a reasonable time after receipt of the defective product at our authorized service center.

HOW TO OBTAIN WARRANTY SERVICE

You must notify your local Crown importer of your need for warranty service within the warranty period. All components must be shipped in the original box. Corrective action will be taken within a reasonable time of the date of receipt of the defective product by our authorized service center. If the repairs made by our authorized service center are not satisfactory, notify our authorized service center immediately.

DISCLAIMER OF CONSEQUENTIAL AND INCIDENTAL DAMAGES

YOU ARE NOT ENTITLED TO RECOVER FROM US ANY INCIDENTAL DAMAGES RESULTING FROM ANY DEFECT IN THE NEW CROWN PRODUCT. THIS INCLUDES ANY DAMAGE TO ANOTHER PRODUCT OR PRODUCTS RESULTING FROM SUCH A DEFECT.

WARRANTY ALTERATIONS

No person has the authority to enlarge, amend, or modify this Crown Warranty. This Crown Warranty is not extended by the length of time which you are deprived of the use of the new Crown product. Repairs and replacement parts provided under the terms of this Crown Warranty shall carry only the unexpired portion of this Crown Warranty.

DESIGN CHANGES

We reserve the right to change the design of any product from time to time without notice and with no obligation to make corresponding changes in products previously manufactured.

LEGAL REMEDIES OF PURCHASER

No action to enforce this Crown Warranty shall be commenced after expiration of the warranty period.

THIS STATEMENT OF WARRANTY SUPERSEDES ANY OTHERS CONTAINED IN THIS MANUAL FOR CROWN PRODUCTS. 7/01



Crown Factory Service Information

Shipping Address: Crown Factory Service, 1718 W. Mishawaka Rd., Elkhart, IN 46517

Phone: 1-800-342-6939 or 1-574-294-8200 Fax: 1-574-294-8124

Owner's Name : _____

Shipping Address: _____

Phone Number: _____ Fax Number: _____ Email _____

Model: _____ Serial Number: _____

Purchase Date : _____

NATURE OF PROBLEM

(Be sure to describe the conditions that existed when the problem occurred and what attempts were made to correct it.)

Other equipment in system: _____

If warranty has expired, payment will be: Cash/Check Visa Master Card C.O.D. Purchase Order for Crown Dealer

Card Number: _____ Exp. Date: _____

Signature: _____

ENCLOSE THIS PORTION WITH THE UNIT. DO NOT MAIL SEPARATELY.



H A Harman International Company

Free Manuals Download Website

<http://myh66.com>

<http://usermanuals.us>

<http://www.somanuals.com>

<http://www.4manuals.cc>

<http://www.manual-lib.com>

<http://www.404manual.com>

<http://www.luxmanual.com>

<http://aubethermostatmanual.com>

Golf course search by state

<http://golfingnear.com>

Email search by domain

<http://emailbydomain.com>

Auto manuals search

<http://auto.somanuals.com>

TV manuals search

<http://tv.somanuals.com>